

nopa[®] instruments

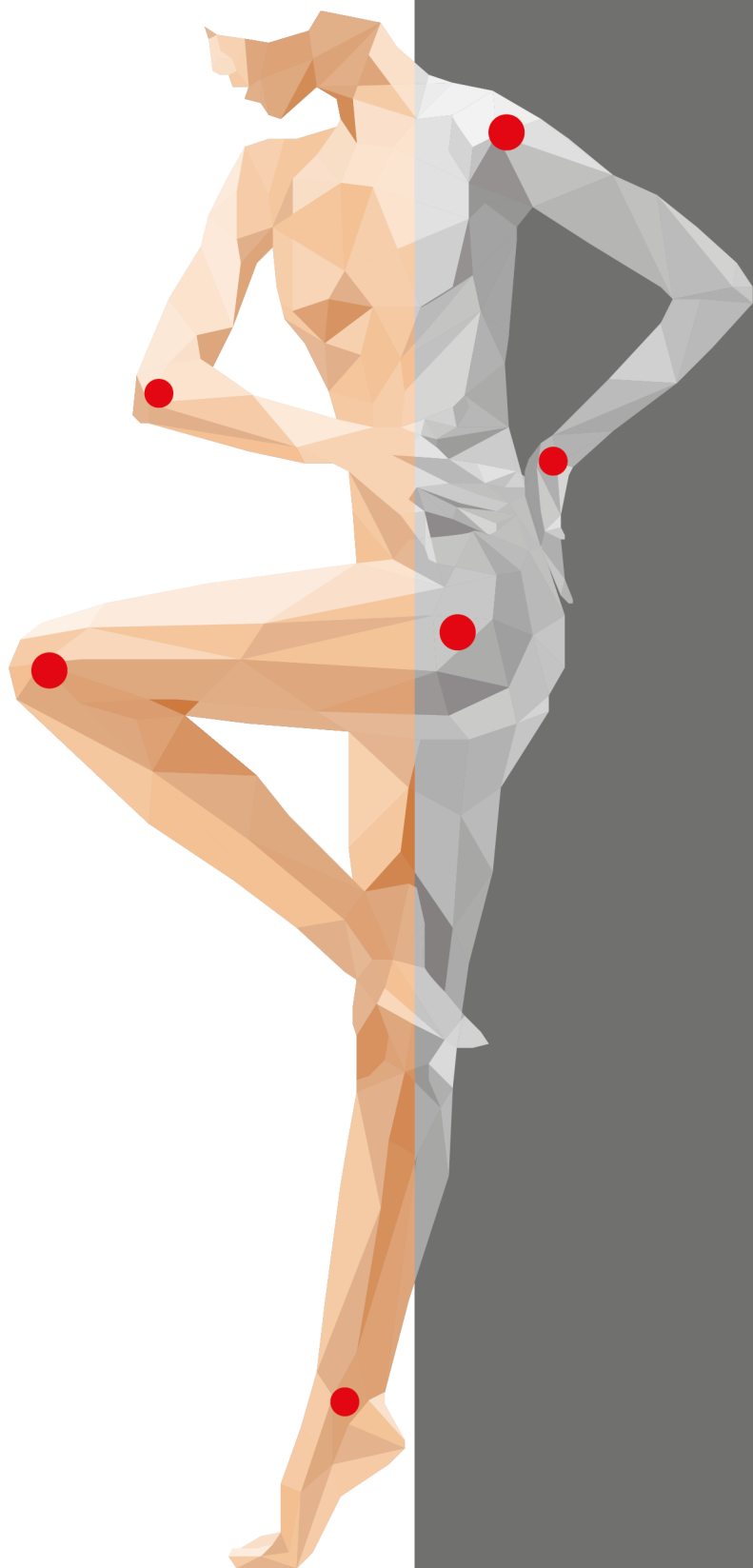

arthroskopie
arthroscopy
artroscopia
arthroscopie
artroscopia

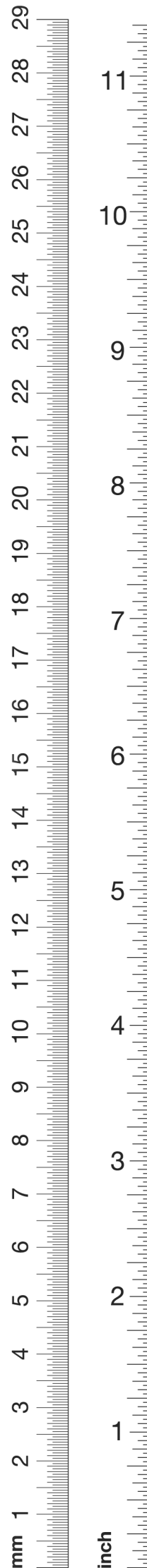

Dies ist unser Katalog Arthroskopie, er bleibt unser ausschließliches Eigentum. Es gelten unsere allgemeinen Lieferbedingungen. Sie finden diese auf unserer Internetseite: www.nopa.de

This is our arthroscopy catalogue. It remains our exclusive property. Please find our "General Terms of Sale" on our corporate website: www.nopa.de

Esto es nuestro catálogo de artroscopia. El catálogo queda nuestra propiedad. Nuestros condiciones generales de venta se encuentran en nuestra página web: www.nopa.de

Voilà notre catalogue pour l'arthroscopie. Il demeure notre propriété. Veuillez consulter nos conditions générales de vente sur notre page Internet: www.nopa.de

Ecco il nostro catalogo di artroscopia. Il catalogo rimane di nostra proprietà. Trovate le nostre condizioni generali di fornitura sul nostro sito: www.nopa.de

corporate video



Scan QR-Code or visit
www.nopa.de

Wir weisen ausdrücklich darauf hin, dass die gezeigten/genannten Produkte nur von ausgebildetem Fachpersonal mit entsprechender Qualifikation und unter der Voraussetzung des sachgemäßen, zweckbestimmten und bestimmungsgemäßen Gebrauchs, laut Angaben der Bedienungsanleitung verwendet und eingesetzt werden dürfen. Unsachgemäße und die nicht bestimmungsmäßige Verwendung der Produkte, kann zu schwerwiegenden und unerwünschten Folgen, sowie Komplikationen führen.

We expressly point out that the products shown/mentioned may only be used and operated by trained specialist personnel with the appropriate qualifications, and for the proper, intended and prescribed purpose as specified in the operating instructions. Improper and/or non-prescribed use of the products may lead to serious and undesirable consequences as well as complications.

Modelländerungen vorbehalten. Nachdruck, auch auszugsweise, verboten.
Change of design and pattern reserved. Re-printing, even in extracts, not permitted.
Nos reservamos el derecho de modificaciones sin aviso previo. Reimpresión, también parcialmente, está prohibido.
Tous droits réservés aux changements de modèle. Réimprimer, également partiellement, est interdit.
Noi riserviamo il diritto di effettuare delle modificazioni. Ristampa di divieto anche parziale.

Bitte fordern Sie unsere
entsprechenden Kataloge an.

Please request for our
appropriate catalogues.

Por favor pida nuestros
catálogos apropiados.

Veuillez demander nos
catalogues appropriés.

Vi preghiamo di richiedere
il catalogo appropriato.

>> Unser Lieferprogramm

Allgemeine Chirurgie
Gynäkologie und Urologie
Hysteroskopie
Zystoskopie
Plastische Chirurgie und HNO
Thorax, Herz und Gefäßchirurgie
Neurochirurgie
Ophthalmologie
Endoskopie
Arthroskopie
Container und Sterilisation
Dental und Oral
Podologie

>> Our product range

General Surgery
Gynecology and Urology
Hysteroscopy
Cystoscopy
Plastic Surgery and ENT
Thoracic and cardiovascular surgery
Neurosurgery
Ophthalmology
Endoscopy
Arthroscopy
Container and sterilization
Dental and Oral
Podology

**>> Nuestro gama
de productos**

Cirugía general
Ginecología y Urología
Histeroscopia
Cistoscopia
Cirugía plástica y ORL
Cirugía torácica y cardiovascular
Neurocirugía
Oftalmología
Endoscopia
Artroscopia
Contenedor y esterilización
Odontología y Oral
Podología

>> Notre gamme

Chirurgie générale
Gynécologie et Urologie
Hystérocopie
Cystoscopie
Chirurgie plastique et ORL
Chirurgie thoracique et cardiovasculaire
Neurochirurgie
Ophtalmologie
Endoscopie
Arthroscopie
Conteneur et stérilisation
Dental et Oral
Podologie

>> La nostra gamma

Chirurgia generale
Ginecologia e Urologia
Isteroscopia
Cistoscopia
Chirurgia plastica ed ORL
Chirurgia toracica e cardiovascolare
Neurochirurgia
Oftalmologia
Endoscopia
Artroscopia
Contentitore e sterilizzazione
Odontoiatria e Orale
Podologia

since

10002



9-43

AA-KA

>> Allgemeine Chirurgie >> General Surgery >> Cirugía general
>> Chirurgie générale >> Chirurgia generale

45-118

KA
arthro

>> Arthroskopie >> Arthroscopy >> Artroscopia
>> Arthroscopie >> Artroscopia

traditionalmodern

119-131

X

>> Endoskopie >> Endoscopy >> Endoscopia
>> Endoscopie >> Endoscopia

133-135

KYE

>> Container System >> Container system >> Sistema de contenedor
>> Système de conteneurs >> Sistema del contenitore

INDEX	INDEX	INDICE	INDEX	INDICE	
>> Klemmen >> Hemostats >> Pinzas hemostáticas >> Pincas hémostatiques >> Pinze emostatiche					10-11 AA
>> Pinzetten >> Forceps >> Pinzas >> Pincas >> Pinze					12-13 AB
>> Scheren >> Scissors >> Tijeras >> Ciseaux >> Forbici					14-17 AC
>> Skalpelle >> Scalpels >> Bisturías >> Bistouris >> Bisturi					18 AD
>> Naht >> Suture >> Sutura >> Suture >> Sutura					19-21 AE
>> Tupferzangen >> Sponge forceps >> Pinzas para pólipos >> Pincas à pansements >> Pinze per polipi					22 AF
>> Wundhaken >> Retractors >> Separadores >> Ecarteurs >> Divaricatori					22-31 AK
>> Orthopädie >> Orthopaedic >> Ortopedia >> Orthopédie >> Ortopedia					32-43 KA
>> Handgriff-Instrumente >> Handgrip instruments >> Instrumentos con mango >> Instruments avec poignées >> Strumenti con manico					46-50
>> Stanzen, Scheren, Fasszangen >> Punches, scissors, grasping forceps >> Punzones, tijeras, pinzas de agarre >> Pincas emporte-pièces, ciseaux, pincas à préhension >> Pinze, forbici, pinze da presa					52-55
>> Knie-Instrumente >> Knee instruments >> Instrumentos de rodilla >> Instruments pour le genou >> Strumenti per il ginocchio					61-79
>> Kleingelenk-Instrumente >> Small joint instruments >> Instrumentos de articulación pequeña >> Instruments pour les petites articulations >> Strumenti per le piccole articolazioni					81-87
>> Schulter-Instrumente >> Shoulder instruments >> Instrumentos de hombro >> Instruments pour l'épaule >> Strumenti per la spalla					89-109
>> Hüft-Instrumente >> Hip instruments >> Instrumentos de cadera >> Instruments pour la hanche >> Strumenti per l'anca					111-118 KA arthro
>> Spülkanülen >> Irrigation cannula >> Canula de irrigación >> Canule d'irrigation >> Cannule di irrigazione					120
>> Arthroskope und Arthroskopieschäfte >> Arthroscopes and arthroscopic sheaths >> Artroscopios y vainas de artroscopios >> Arthroscopes et chemises d'arthroscopie >> Artroscopia e camicie					121-125
>> Elektroden, Anschlusskabel >> Electrodes, connection cords >> Electrodos, cables de conexión >> Électrodes, cables de raccordement >> Elettrodi e cavi					126-127
>> Kaltlichtkabel, Adapter >> Fibre optic cable, adapter >> Cable de fibra óptica, adaptador >> Cordons de lumière froide, adaptateurs >> Cavo fibra ottica, adattatori					128
>> Geräte >> Equipment >> Equipos >> Équipements >> Equipaggiamento					129-131 X
>> Container System >> Container system >> Sistema de contenedor >> Système de conteneurs >> Sistema del contenitore					133-135 KYE

nopa bietet eine große Auswahl an Arthroskopie-Instrumenten für Knie-, Schulter-, Hüft- und Kleingelenke. Alle Instrumente überzeugen durch Schärfe, Kraft und Stabilität. Ausgewählte Instrumente (Produktlinie „modern“) bestechen durch stiftlos angefertigte Arbeitsenden und Führungsschienen. Die Vielfalt der Arbeitsenden wird ergänzt durch verschiedene Variationen an Handgriffen, die komfortabel in der Hand des Anwenders liegen und ein angenehmes Arbeiten ermöglichen. Die aufgeführten Instrumente finden ihre Anwendung in folgenden Bereichen:

nopa offers a large range of arthroscopy instruments for knee, shoulder, hip and small joints. All the instruments are impressively sharp, powerful and robust. Selected instruments (the “modern” product range) also use pinless technology in the working ends and offer guide tracks. In addition to a wide variety of working ends, the instruments come with various handle options, offering an ergonomic grip and enabling the user to work in comfort. The instruments listed are used in the following areas:



Knie
knee



Handgelenk / Ellenbogen / Sprunggelenk
wrist / elbow / ankle



Schulter
shoulder



Hüfte
hip

ALLGEMEINE CHIRURGIE
GENERAL SURGERY
CIRUGÍA GENERAL
CHIRURGIE GÉNÉRALE
CHIRURGIA GENERALE

AA-KA

Weitere allgemeine Instrumente finden Sie in unserem Katalog „**Allgemeine Chirurgie**“.

For further general instruments kindly refer to our catalogue „**general surgery**“.

Para instrumental general adicional, consulte nuestro catálogo de „**cirugía general**“.

Pour d'autres instruments généraux, veuillez consulter notre catalogue „**chirurgie générale**“.

Per ulteriori strumenti generali, consultate il nostro catalogo „**chirurgia generale**“.



Feine Arterienklemmen
 Fine artery forceps
 Pinzas hemostáticas finas
 Pincas hémostatiques fines
 Pinze emostatiche fine

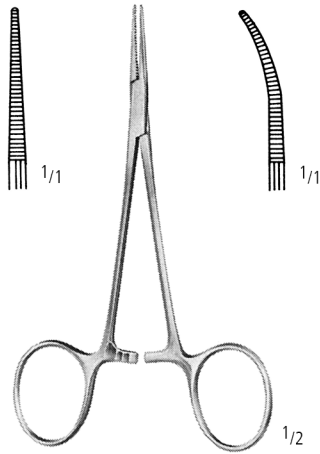

MICRO-MOSQUITO

AA 130/10 AA 131/10
 AA 130/12 AA 131/12

10,0 cm/4"
 12,0 cm/4¾"

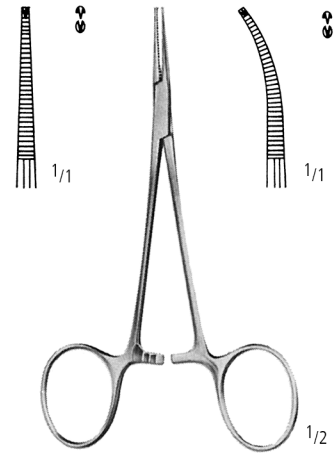

MICRO-MOSQUITO 1:2

AA 132/10 AA 133/10
 AA 132/12 AA 133/12

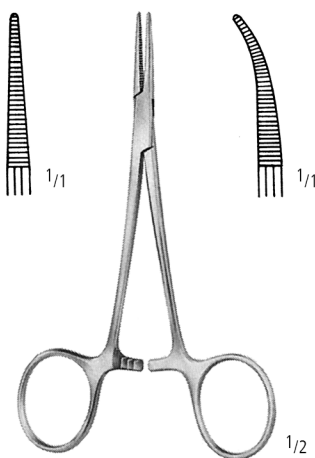

HALSTED-MOSQUITO

AA 150/12 AA 151/12
 AA 150/14 AA 151/14

12,5 cm/5"
 14,0 cm/5½"

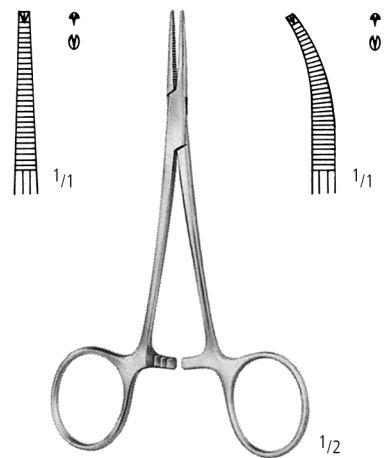

HALSTED-MOSQUITO 1:2

AA 152/12 AA 153/12
 AA 152/14 AA 153/14

KLEMMEN HEMOSTATS PINZAS HEMOSTATICAS PINCES HEMOSTATIQUES PINZE EMOSTATICHE

Tuchklemmen
Towel forceps
Pinzas para compresas, pinzas de campo
Pinces à champs, pinces à compresas
Pinze per fissare le compresse (Fissatele)

AA

AB

AC

AD

AE

AF

AK

KA

KA
arthro

X

KYE

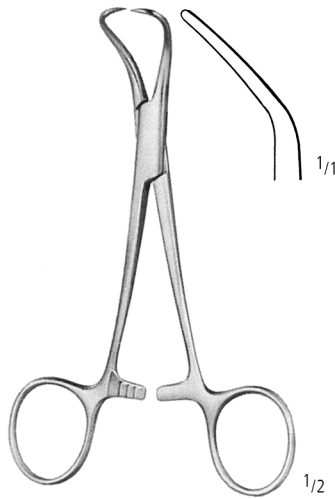

BACKHAUS

- 8,0 cm/3" **AA 751/08**
- 11,0 cm/4 1/3" **AA 751/11**
- 13,0 cm/5" **AA 751/13**
- 15,0 cm/6" **AA 751/15**



BALL & SOCKET

- 11,0 cm/4 1/3" **AA 753/11**
- 13,0 cm/5" **AA 753/13**

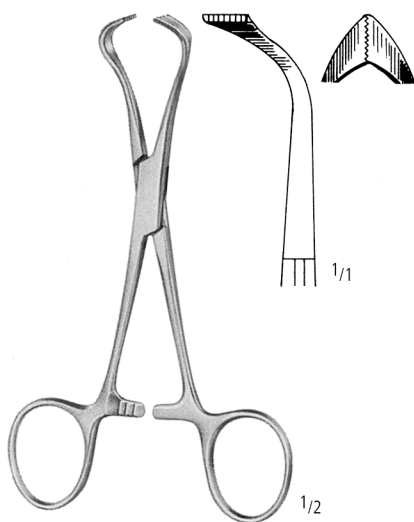

LORNA

- 10,0 cm/4" **AA 763/10**
- 13,0 cm/5" **AA 763/13**

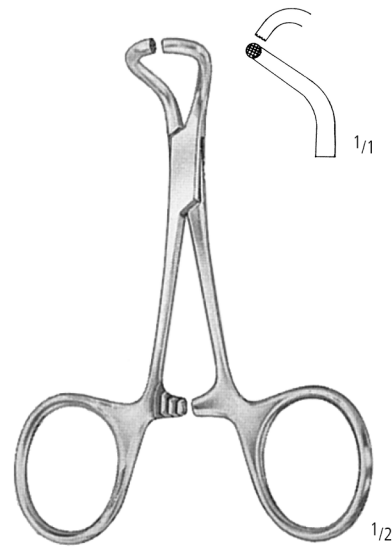

TOHOKU-JAPAN

- 10,0 cm/4" **AA 764/10**
- 13,0 cm/5" **AA 764/13**

AB PINZETTEN FORCEPS PINZAS PINCES PINZE

Anatomische Pinzetten, Chirurgische Pinzetten
 Dressing forceps, tissue forceps
 Pinzas de disección, pinzas de disección con dientes
 Pincés à dissection, pincés à griffes
 Pinze anatomiche per dissezione, pinze chirurgiche a denti di topo

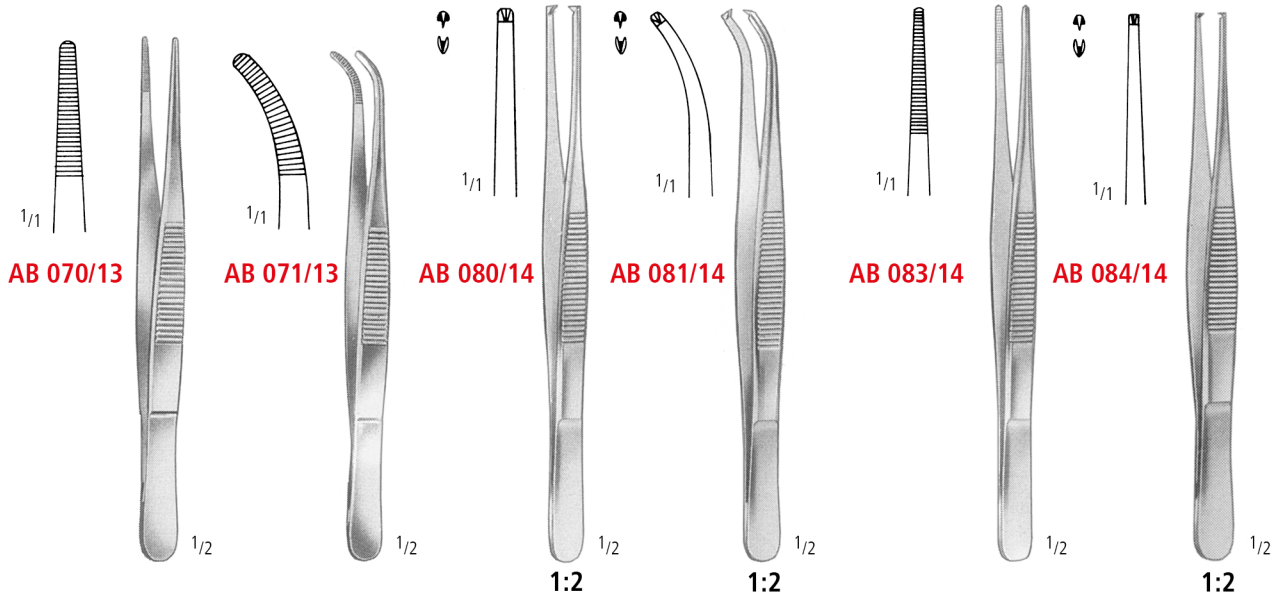

schmal - narrow - estrechas - étroites - strette

fein - delicate - finas - fines - fine

- 10,5 cm/4 1/4"
- 11,5 cm/4 1/2"
- 13,0 cm/5"
- 14,5 cm/5 3/4"
- 16,0 cm/6 1/4"
- 18,0 cm/7"
- 20,0 cm/8"
- 23,0 cm/9"
- 25,0 cm/10"
- 30,0 cm/12"

AB 070/10	AB 071/10	AB 080/10	AB 081/10		
AB 070/11	AB 071/11	AB 080/11	AB 081/11		
AB 070/13	AB 071/13	AB 080/13	AB 081/13	AB 083/13	AB 084/13
AB 070/14	AB 071/14	AB 080/14	AB 081/14	AB 083/14	AB 084/14
AB 070/16	AB 071/16	AB 080/16	AB 081/16		
AB 070/18	AB 071/18	AB 080/18	AB 081/18		
AB 070/20	AB 071/20	AB 080/20	AB 081/20		
AB 070/23		AB 080/23			
AB 070/25	AB 071/25	AB 080/25	AB 081/25		
AB 070/30	AB 071/30	AB 080/30	AB 081/30		

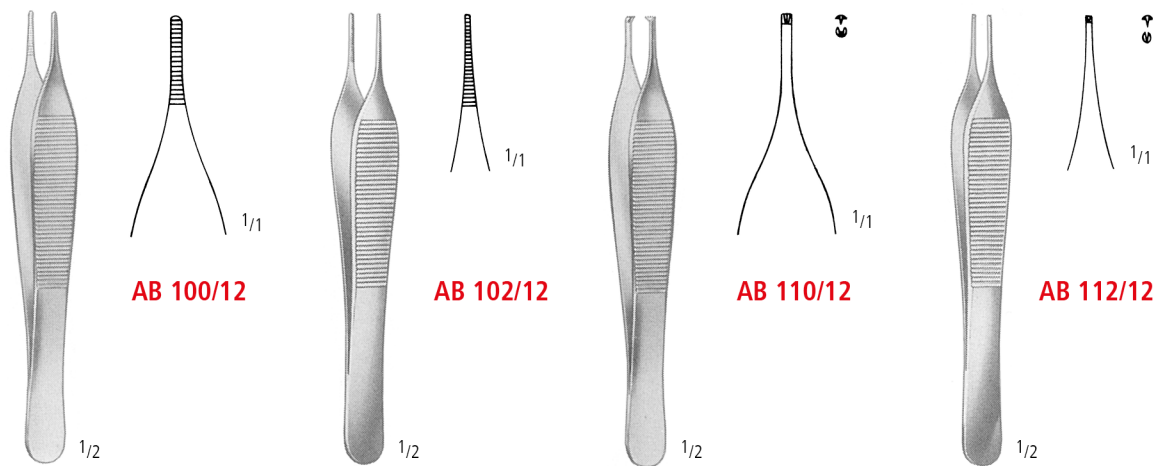

	ADSON	MICRO-ADSON	ADSON 1:2	MICRO-ADSON 1:2
12,0 cm/4 3/4"	AB 100/12	AB 102/12	AB 110/12	AB 112/12
15,0 cm/6"	AB 100/15	AB 102/15	AB 110/15	AB 112/15

PINZETTEN FORCEPS PINZAS PINCES PINZE

Chirurgische Pinzetten, Fasspinzetten
 Tissue forceps, grasping forceps
 Pinzas de disección con dientes, pinzas para coger
 Pincas à griffes, pincas pour saisir les tissus
 Pinze chirurgiche a denti di topo, pinze per afferrare tessuti

AA

AB

AC

AD

AE

AF

AK

KA

KA
arthro

X

KYE

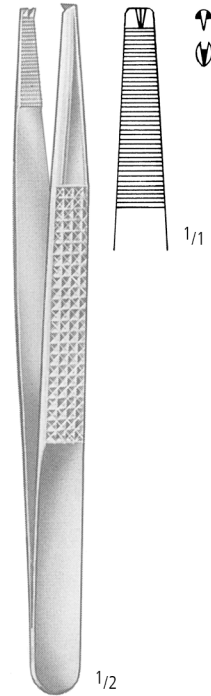

BONNEY 1:2
AB 490/18
 18,0 cm/7"

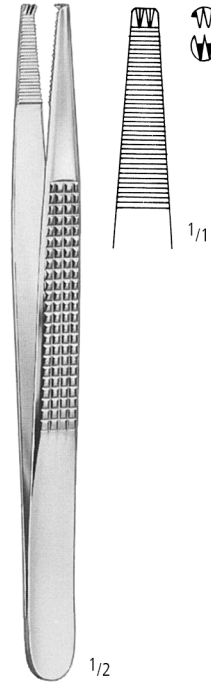

BONNEY 2:3
AB 492/18
 18,0 cm/7"



ADSON



AB 930/12
 12,0 cm/4¾"



AB 932/12
 12,0 cm/4¾"



AB 930/15
 15,0 cm/6"

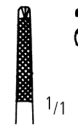

AB 932/15
 15,0 cm/6"

AC SCHEREN SCISSORS TIJERAS CISEAUX FORBICI

Chirurgische Scheren
 Operating scissors
 Tijeras para cirugía
 Ciseaux à chirurgie
 Forbici per chirurgia



nopa® SC
SUPER CUT

Besonderheit:

nopa Super Cut Scheren haben eine rasierklingscharfe Schneide, kombiniert mit einer mikrogezahnten Schneide.

Features:

nopa Super Cut scissors have a razor-like edge combined with one micro serrated blade.

Verfügbare SC-Modelle sind im Katalog durch * markiert.

Available SC patterns are marked in the catalogue with *

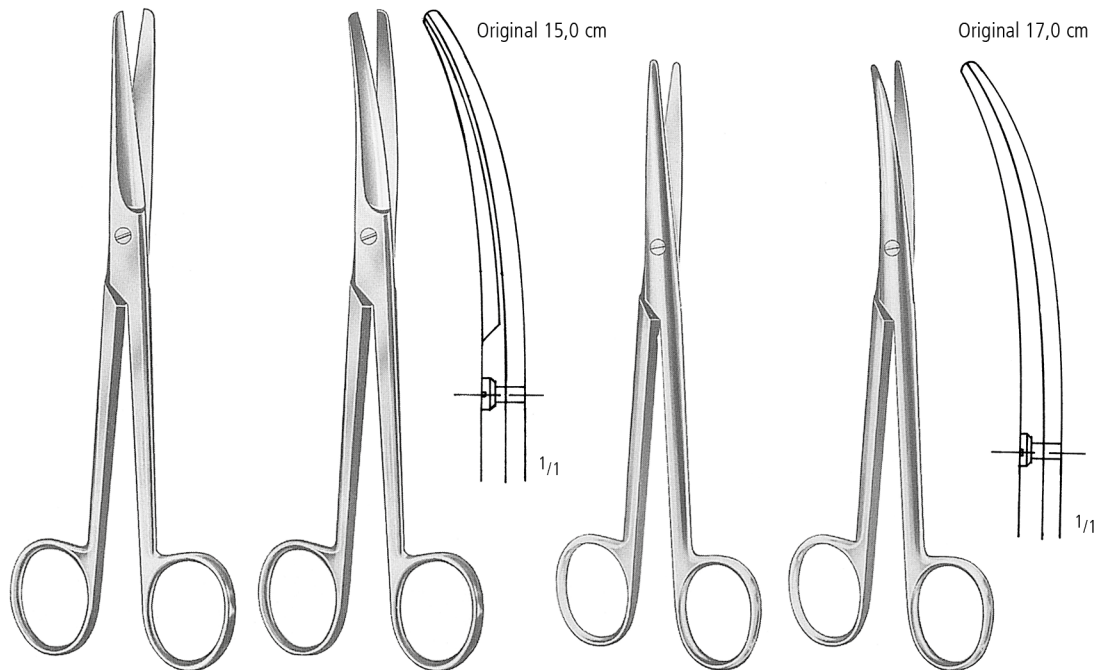

MAYO

MAYO-STILLE

14,5 cm/5¾"	AC 070/14*	AC 071/14*		
15,0 cm/6"			AC 072/15	AC 073/15
17,0 cm/6¾"	AC 070/17*	AC 071/17*	AC 072/17	AC 073/17*
19,5 cm/7¾"			AC 072/19	AC 073/19
21,0 cm/8¼"			AC 072/21	AC 073/21
23,0 cm/9"	AC 070/23*	AC 071/23*		
28,0 cm/11"	AC 070/28	AC 071/28		

SCHEREN SCISSORS TIJERAS CISEAUX FORBICI

Präparierscheren
Dissecting scissors
Tijeras para preparaciones
Ciseaux à dissection
Forbici per preparazioni

AA

AB

AC

AD

AE

AF

AK

KA

KA
arthro

X

KYE

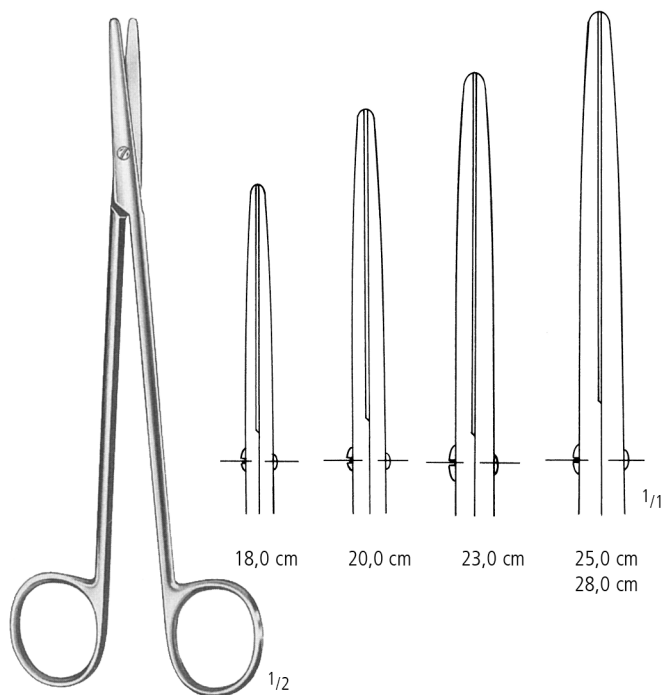

METZENBAUM-NELSON

METZENBAUM-NELSON



Fig. 1

Fig. 2

Fig. 3

18,0 cm/7"	AC 110/18*	AC 111/18*	AC 120/18	AC 121/18	AC 130/18	AC 131/18
20,0 cm/8"	AC 110/20*	AC 111/20*	AC 120/20	AC 121/20	AC 130/20	AC 131/20
23,0 cm/9"	AC 110/23*	AC 111/23*	AC 120/23	AC 121/23	AC 130/23	AC 131/23
25,0 cm/10"	AC 110/25	AC 111/25	AC 120/25	AC 121/25	AC 130/25	AC 131/25
28,0 cm/11"	AC 110/28	AC 111/28	AC 120/28	AC 121/28	AC 130/28	AC 131/28
30,0 cm/12"	AC 110/30	AC 111/30	AC 120/30	AC 121/30	AC 130/30	AC 131/30

AC SCHEREN SCISSORS TIJERAS CISEAUX FORBICI

Präparierscheren
 Dissecting scissors
 Tijeras para preparaciones
 Ciseaux à dissection
 Forbici per preparazioni

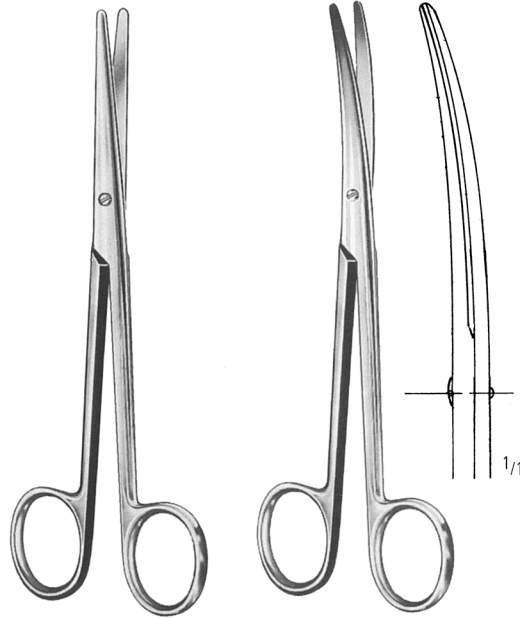

LEXER
AC 170/16
 16,0 cm/6¼"

LEXER
AC 171/16
 16,0 cm/6¼"

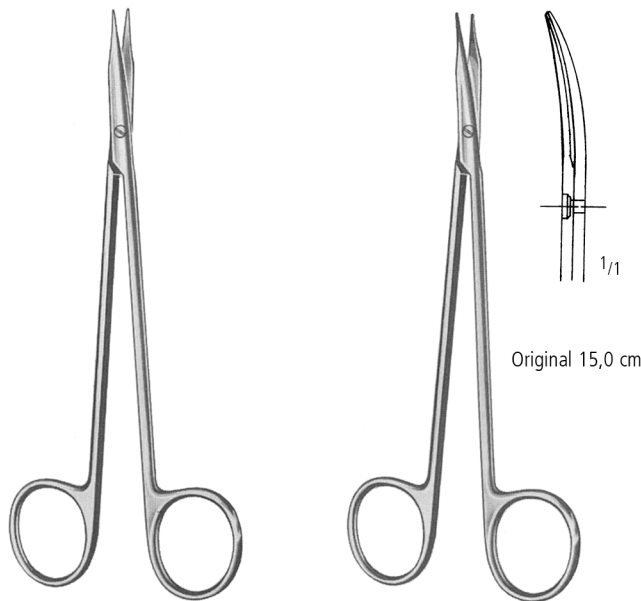

REYNOLDS
AC 214/15* 15,0 cm/6"
AC 214/18* 18,0 cm/7"

AC 215/15
AC 215/18

SCHEREN SCISSORS TIJERAS CISEAUX FORBICI

Scheren mit Hartmetalleinlagen
 Scissors with tungsten carbide inserts
 Tijeras con filos de carburo de tungsteno
 Ciseaux avec plaquettes en carbure de tungstène
 Forbici con taglio al carburo di tungsteno

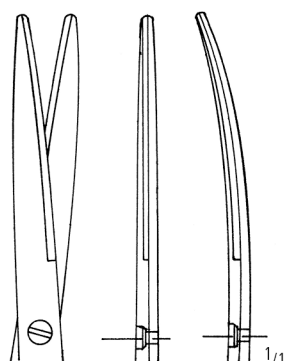

Original 18,0 cm

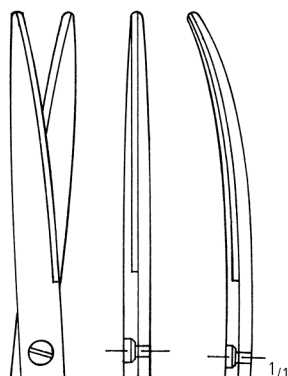

Original 20,0 cm

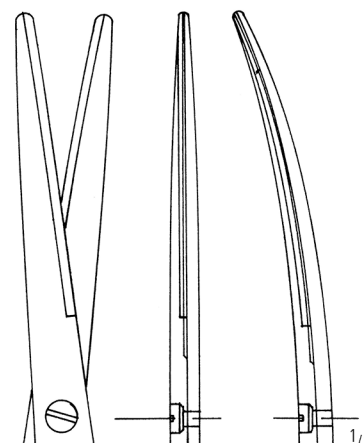

Original 23,0 cm



METZENBAUM-DELICATE

nopa®
TUC

gerade
 straight
 rectas
 droits
 rette

gebogen
 curved
 curvas
 courbes
 curve

AC 970/18*	18,0 cm/7"	AC 971/18*
AC 970/20*	20,0 cm/8"	AC 971/20*
AC 970/23	23,0 cm/9"	AC 971/23
AC 970/25	25,0 cm/10"	AC 971/25
AC 970/28	28,0 cm/11"	AC 971/28

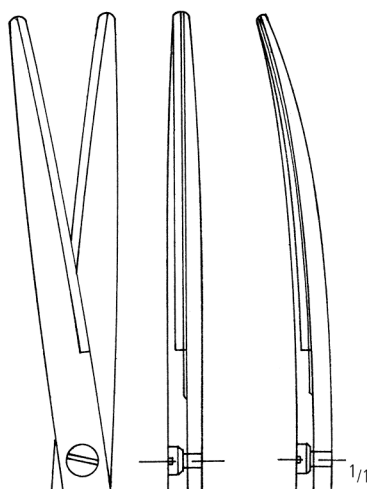

Original 25,0 cm

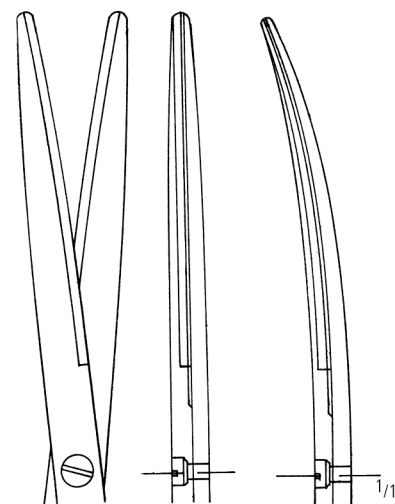

Original 28,0 cm

AA
 AB
AC
 AD
 AE
 AF
 AK
 KA
 KA
 X
 KYE

AD SKALPELLE SCALPELS BISTURIES BISTOURIS BISTURI

Skalpellgriffe
 Scalpel handles
 Mangos de bisturías
 Manches pour bistouris
 Manici per bisturi



AD 010/03
No. 3



AD 010/04
No. 4

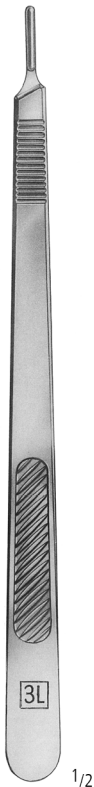

AD 020/13
No. 3L



AD 020/14
No. 4L



AD 030/16



AD 031/16
No. 3



AD 031/21

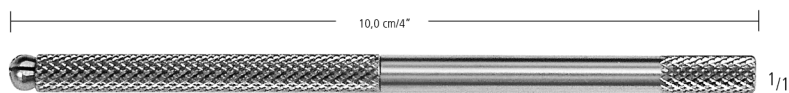

AD 065/10

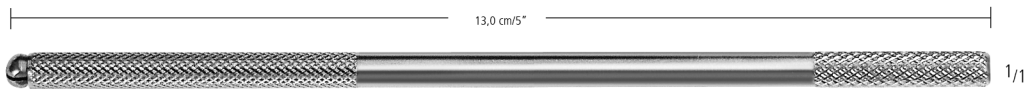

AD 065/13

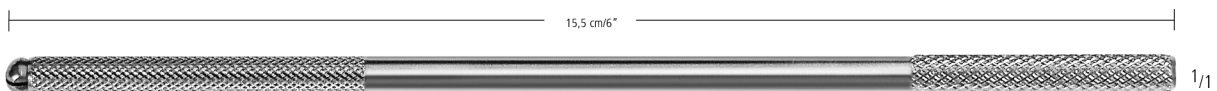

AD 065/15

NAHT SUTURE SUTURA SUTURE SUTURA

Nadelhalter mit Hartmetalleinsätzen
 Needle holders with tungsten carbide inserts
 Porta-agujas con bocas de carburo de tungsteno
 Porte-aiguilles à mors en carbure de tungstène
 Portaghi con placche di carburo di tungsteno

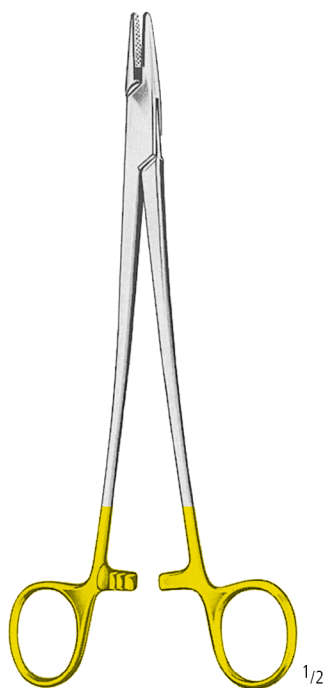

MAYO-HEGAR



AE 400/14
14,0 cm/5½"



AE 400/16
16,0 cm/6¼"



AE 400/18
18,0 cm/7"



AE 400/20
20,0 cm/8"



AE 400/24
24,0 cm/9½"



AE 400/26
26,0 cm/10½"



AE 400/30
30,0 cm/12"



AE 400/36
36,0 cm/14"



AE 420/18
18,0 cm/7"



AE 420/20
20,0 cm/8"



AE 420/23
23,0 cm/9"



AE 420/26
26,0 cm/10½"



AE 420/31
31,0 cm/12¼"

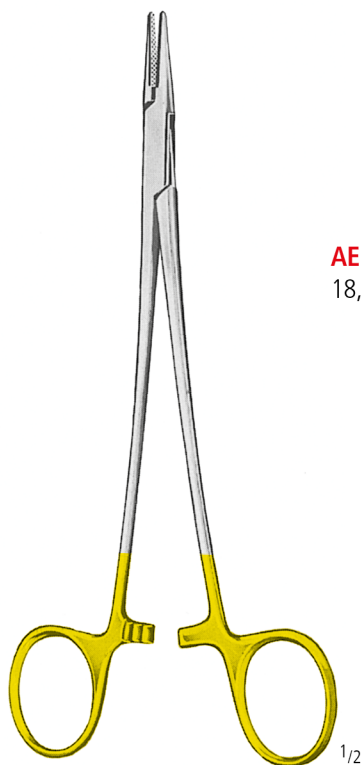

DE-BAKEY
(MAYO-HEGAR-DELICATE)

AA
AB
AC
AD
AE
AF
AK
KA
KA
arthro
X
KYE

AE NAHT SUTURE SUTURA SUTURE SUTURA

Nadelhalter mit Hartmetalleinsätzen
 Needle holders with tungsten carbide inserts
 Porta-agujas con bocas de carburo de tungsteno
 Porte-aiguilles à mors en carbure de tungstène
 Portaghi con placche di carburo di tungsteno

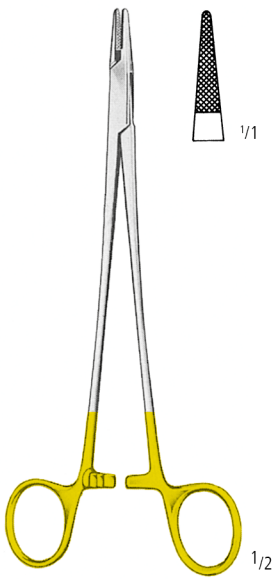

BABY-CRILE-WOOD
AE 468/15
 15,0 cm/6"

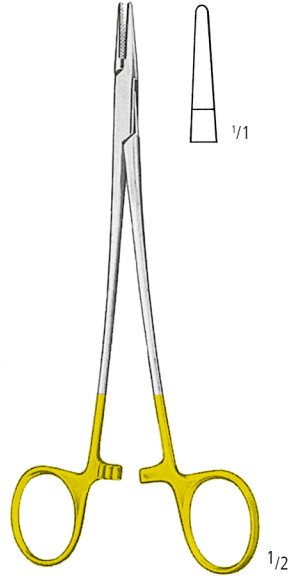

CRILE-WOOD
AE 469/15
 15,0 cm/6"

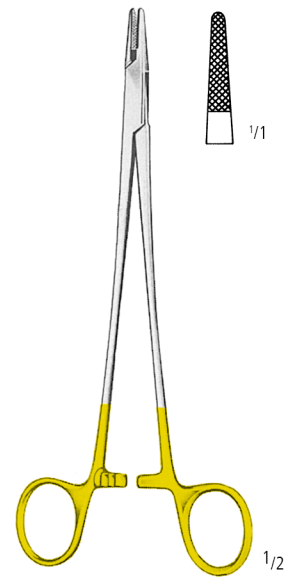

CRILE-WOOD
AE 470/15
 15,0 cm/6"

nopa®
TUC

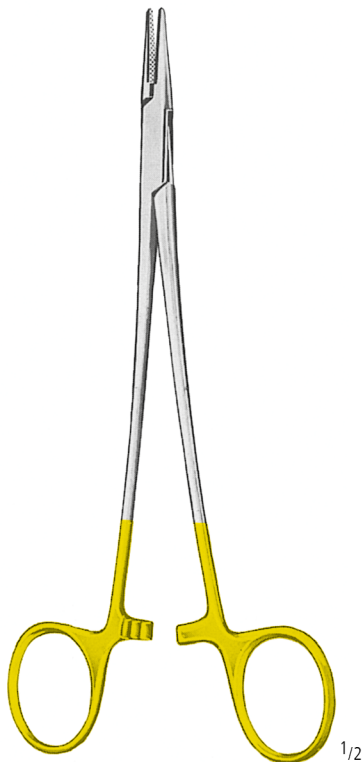

CRILE-WOOD



AE 470/18
 18,0 cm/7"



AE 470/20
 20,0 cm/8"



AE 470/23
 23,0 cm/9"



AE 471/18
 18,0 cm/7"



AE 471/23
 23,0 cm/9"

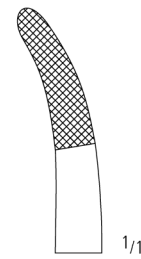

AE 471/36
 36,0 cm/14"

NAHT SUTURE SUTURA SUTURE SUTURA

Drahtzangen mit Hartmetalleinsätzen
 Wire twisting forceps with tungsten carbide inserts
 Pinzas para torcer hilos con bocas de carburo de tungsteno
 Pincès à torsader le fil à mors en carbure de tungstène
 Pinze per ritorcere fili con placche di carburo di tungsteno

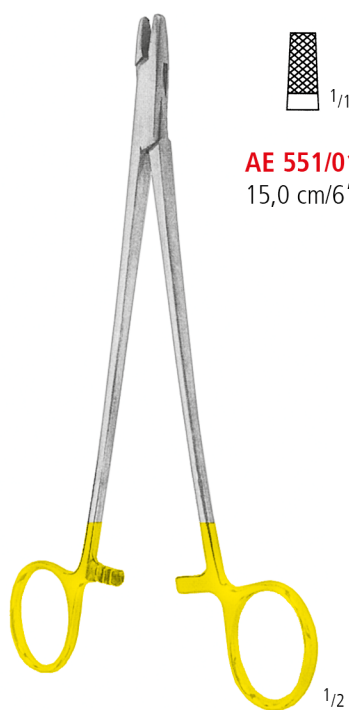

AE 551/01
15,0 cm/6"



1/1



AE 552/18

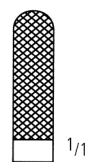

1/1

nopa®
TUC

18,5 cm/7 1/4"

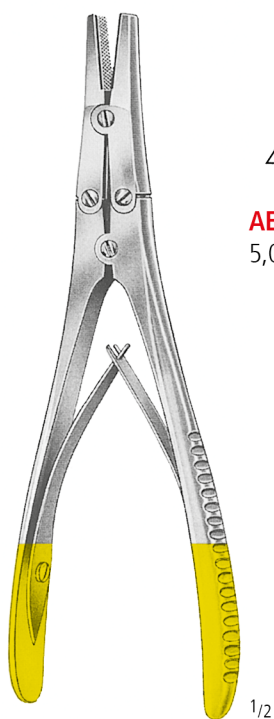

18,0 cm/7"

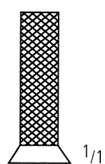

1/1

AE 554/01
5,0 mm

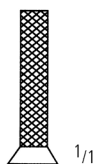

1/1

AE 554/02
3,0 mm



1/1

AE 554/03
7,0 mm



CORWIN

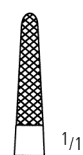

1/1

AE 556/01
16,5 cm/6 1/2"



1/1

AE 556/02
15,0 cm/6"



1/1

AE 556/03
15,0 cm/6"

AA

AB

AC

AD

AE

AF

AK

KA

KA
arthro

X

KYE

AK WUNDHAKEN RETRACTORS SEPARADORES ECARTEURS DIVARICATORI

Tupferzangen, Feine Wundhaken
 Dressing forceps, delicate hooks
 Pinzas para tapones, ganchos
 Pincas à tampons, crochets très fins
 Pinze per tamponi, divaricatori sottili

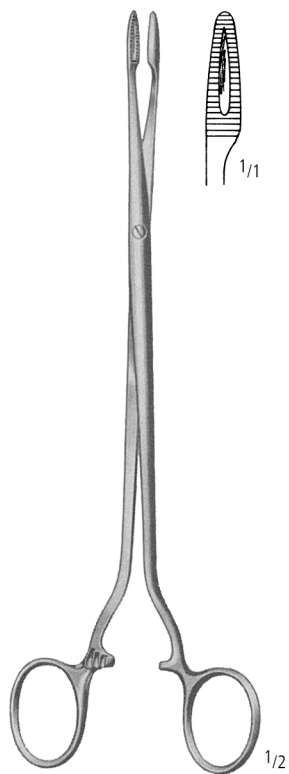

DUPLAY
AF 176/20
 20,5 cm/8"

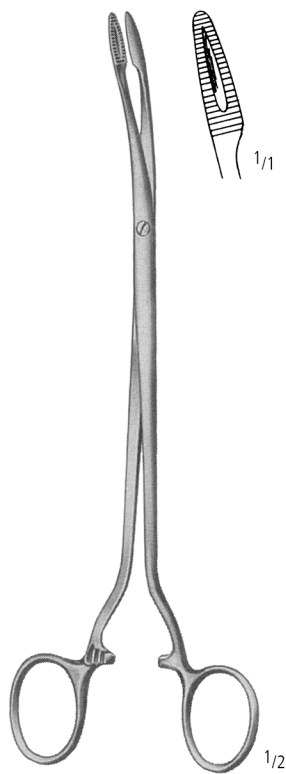

DUPLAY
AF 177/20
 20,5 cm/8"



GILLIES
AK 020/01
 18,0 cm/7"



GILLIES
AK 020/02
 18,0 cm/7"

WUNDHAKEN RETRACTORS SEPARADORES ECARTEURS DIVARICATORI

Feine Wundhaken
Delicate hooks
Ganchos
Crochets très fins
Divaricatori sottili

AA
AB
AC
AD
AE
AF
AK
KA
KA
anthro

X

KYE



16,0 cm/6¼"



AK 050/01



AK 051/01



AK 052/01



AK 050/02



AK 051/02



AK 052/02



AK 050/03



AK 051/03



AK 052/03



AK 050/04



AK 051/04



AK 052/04



16,0 cm/6¼"



AK 060/01



AK 062/01

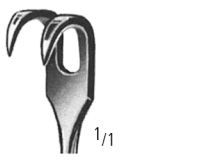

AK 060/02

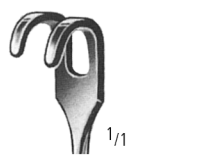

AK 062/02

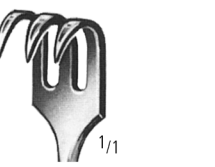

AK 060/03

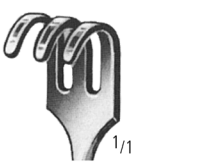

AK 062/03

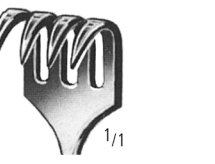

AK 060/04

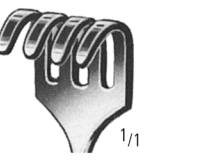

AK 062/04

AK WUNDHAKEN RETRACTORS SEPARADORES ECARTEURS DIVARICATORI

Feine Wundhaken
Delicate hooks
Ganchos
Crochets très fins
Divaricatori sottili

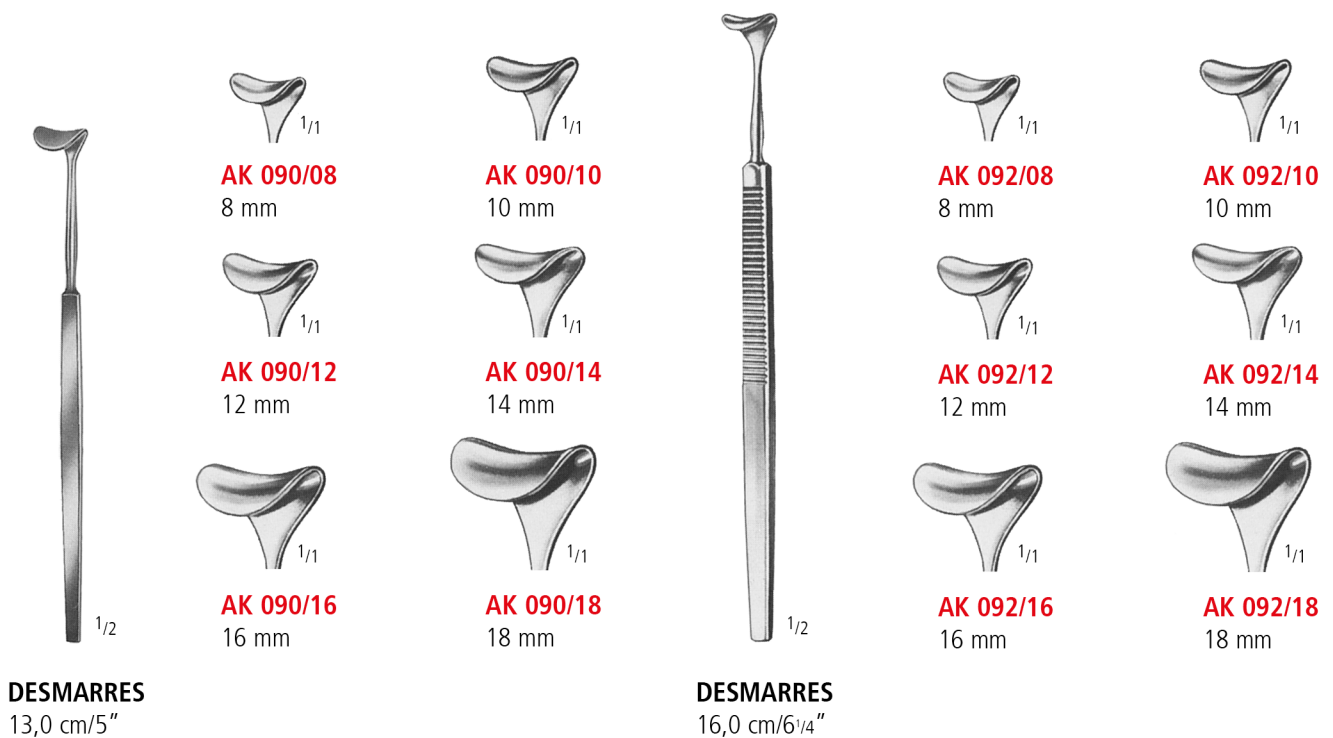
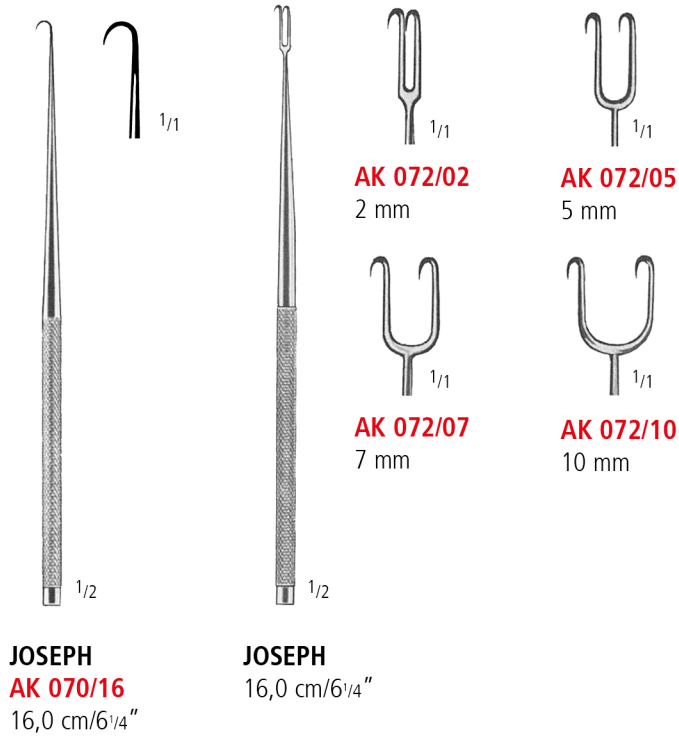

WUNDHAKEN RETRACTORS SEPARADORES ECARTEURS DIVARICATORI

Feine Wundhaken, Wundhaken
 Delicate hooks, retractors
 Ganchos, separadores
 Crochets très fins, ecarteurs
 Divaricatori sottili, divaricatori

AA

AB

AC

AD

AE

AF

AK

KA

KA
arthro

X

KYE

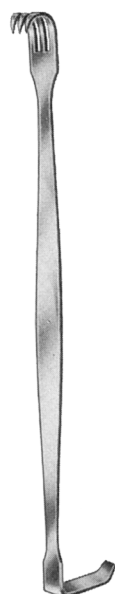

BABY-SENN-MILLER
 15,0 cm/6"

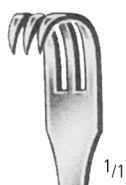

AK 120/15



AK 121/15



SENN-MILLER
 16,0 cm/6¼"



AK 122/16



AK 123/16

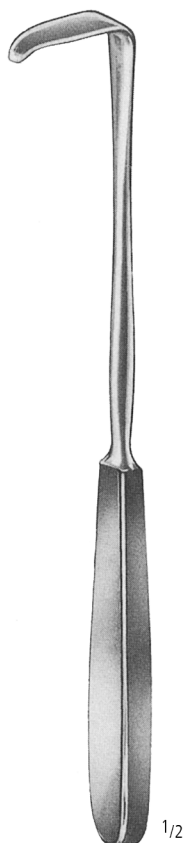

LANGENBECK
AK 230/01-05
 22,0 cm/8¾"



AK 230/01
AK 231/01
 30 x 11 mm



AK 230/02
AK 231/02
 30 x 14 mm

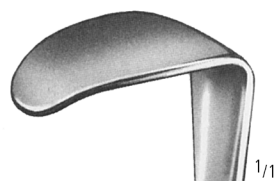

AK 230/03
AK 231/03
 30 x 16 mm

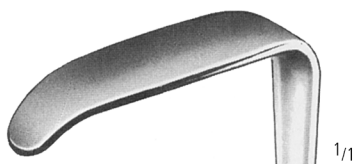

AK 230/04
AK 231/04
 40 x 11 mm

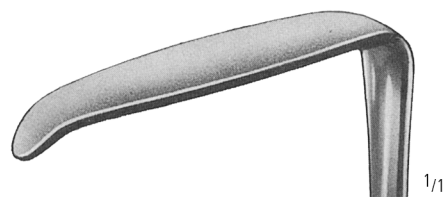

AK 230/05
AK 231/05
 50 x 11 mm

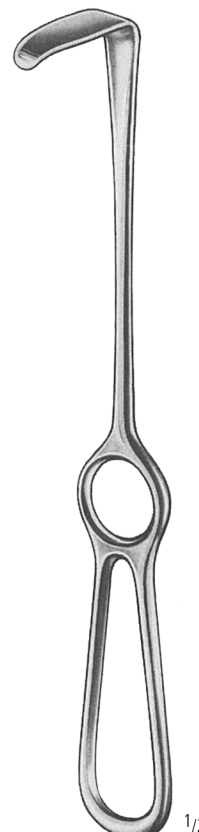

LANGENBECK
AK 231/01-05
 22,0 cm/8¾"

AK WUNDHAKEN RETRACTORS SEPARADORES ECARTEURS DIVARICATORI

Wundhaken
Retractors
Separadores
Ecarteurs
Divaricatori

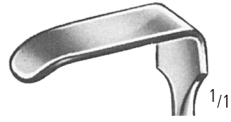

AK 233/01
25 x 6 mm

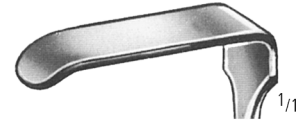

AK 233/02
35 x 8 mm

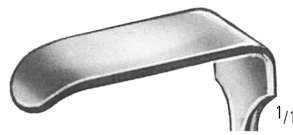

AK 233/03
35 x 11 mm



AK 233/04
35 x 15 mm



AK 233/05
40 x 11 mm

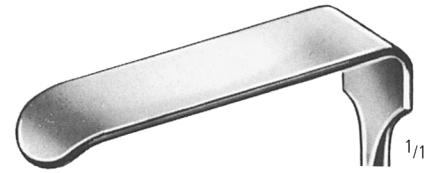

AK 233/06
55 x 11 mm

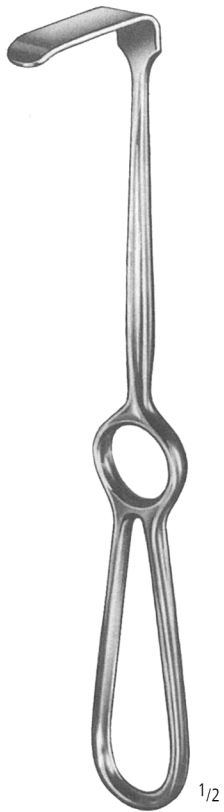

KOCHER-LANGENBECK
21,5 cm/8½"

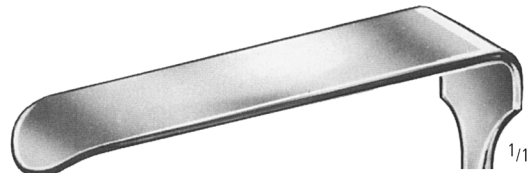

AK 233/07
70 x 14 mm

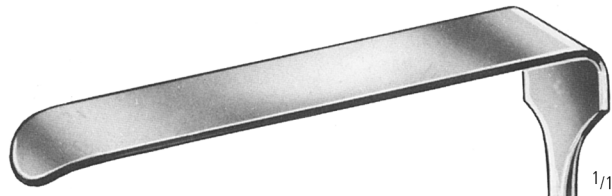

AK 233/08
80 x 12 mm

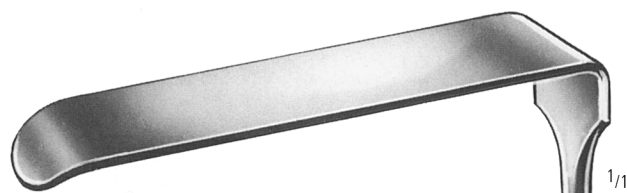

AK 233/09
80 x 16 mm

WUNDHAKEN RETRACTORS SEPARADORES ECARTEURS DIVARICATORI

Wundhaken
Retractors
Separadores
Ecarteurs
Divaricatori

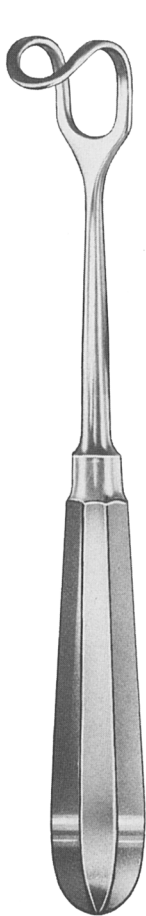

1/2

MIDDELDORPF
AK 244/17-30



1/1

14 X 17 mm

AK 244/17
AK 245/17
21,5 cm/8½"



1/1

20 X 22 mm

AK 244/22
AK 245/22
22,0 cm/8¾"

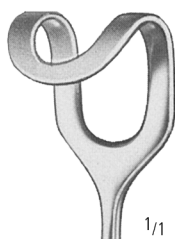

1/1

26 X 30 mm

AK 244/30
AK 245/30
23,5 cm/9⅓"



1/2

MIDDELDORPF
AK 245/17-30



1/1

AK 247/01
28 X 20 mm

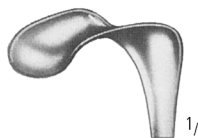

1/1

AK 247/02
36 x 28 mm

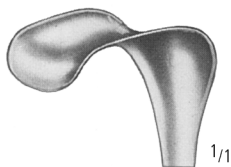

1/1

AK 247/03
44 X 38 mm



1/1

AK 247/04
52 X 22 mm

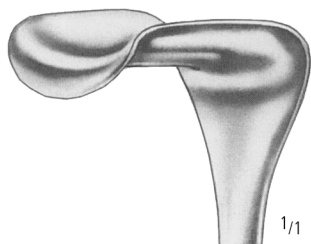

1/1

AK 247/05
65 X 50 mm

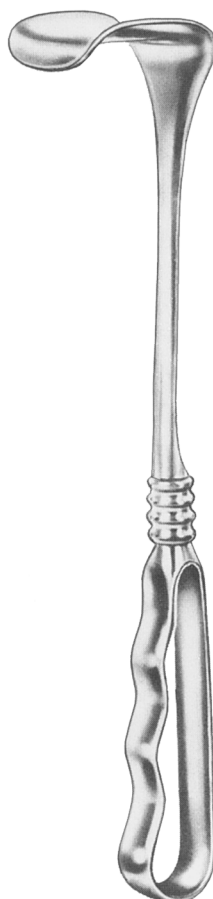

1/2

RICHARDSON (KELLY)
24,0 cm/9½"

AA

AB

AC

AD

AE

AF

AK

KA

KA
arthro

X

KYE

AK WUNDHAKEN RETRACTORS SEPARADORES ECARTEURS DIVARICATORI

Wundhaken
Retractors
Separadores
Ecarteurs
Divaricatori

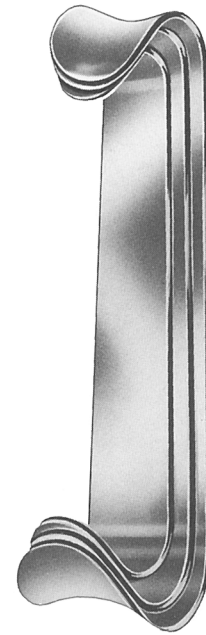
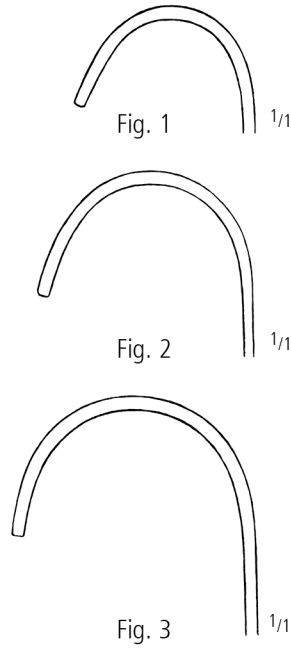
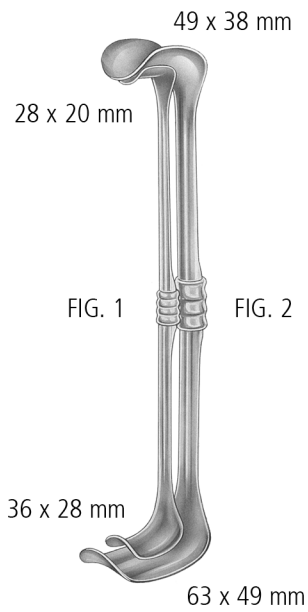

RICHARDSON-EASTMAN

- FIG. 1+2 **AK 248/00**
- FIG. 1 26,0 cm/10 1/2" **AK 248/01**
- FIG. 2 28,0 cm/11" **AK 248/02**

ROUX

- 16,5 cm/6 1/2"
- Fig. 1+2+3 **AK 350/00**
- Fig. 1 **AK 350/01**
- Fig. 2 **AK 350/02**
- Fig. 3 **AK 350/03**



- MATHIEU**
AK 380/00 Fig. 1+2
20,0 cm/8"

- 20,0 cm/8"
- 18x200mm **AK 456/18**
- 20x200mm **AK 456/20**
- 23x200mm **AK 456/23**

WUNDHAKEN RETRACTORS SEPARADORES ECARTEURS DIVARICATORI

Selbsthaltende Wundsperrer
Selfretaining retractors
Separadores autoestaticos
Ecarteurs autostatiques
Divaricatori autostatici



AUSTRALIA
AK 505/01
5,0 cm/2"

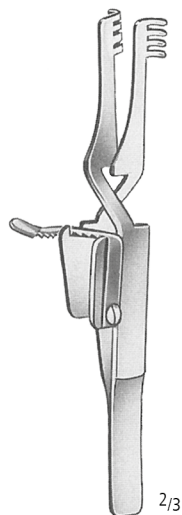

^ ^
AK 502/10 **AK 503/10**
10,0 cm/4"



WEITLANER-BABY
AK 519/14
14,0 cm/5 1/2"



^ ^
WEITLANER
AK 520/13 **AK 521/13**
13,0 cm/5"

- | | |
|-----------------|-------|
| 10,5 cm/4 1/4" | 2 x 3 |
| 13,0 cm/5" | 3 x 4 |
| 16,5 cm/6 1/2" | 3 x 4 |
| 20,0 cm/8" | 3 x 4 |
| 25,0 cm/10" | 3 x 4 |
| 26,0 cm/10 1/2" | 5 x 6 |

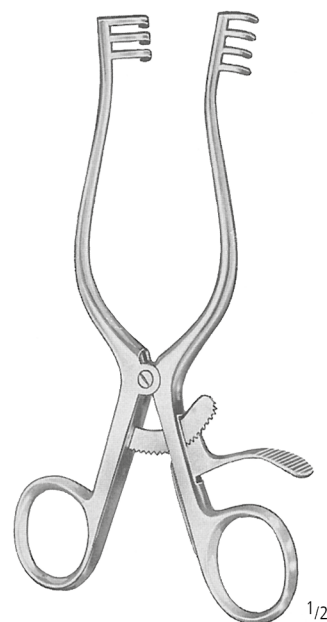

^ ^
WEITLANER
AK 522/10 **AK 523/10**
AK 524/13 **AK 525/13**
AK 526/16 **AK 527/16**
AK 528/20 **AK 529/20**
AK 530/25 **AK 531/25**
AK 532/26 **AK 533/26**

AA
AB
AC
AD
AE
AF
AK
KA
KA
anthro
X
KYE

AK WUNDHAKEN RETRACTORS SEPARADORES ECARTEURS DIVARICATORI

Selbsthaltende Wundsperrer
 Selfretaining retractors
 Separadores autoestaticos
 Ecarteurs autostatiques
 Divaricatori autostatici

komplett
 complete
 completo
 complet
 completo

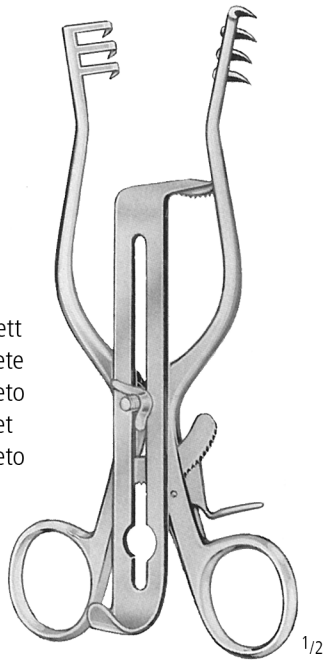

HENLEY

 **AK 536/00**  **AK 537/00**
 16,5 cm/6 1/2"

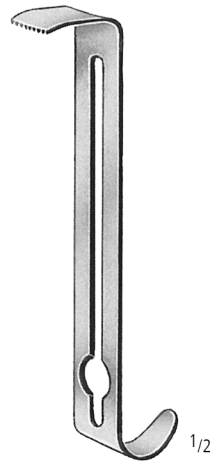

19 mm x 16 mm
AK 536/19

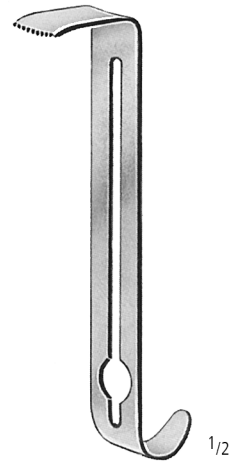

25 mm x 16 mm
AK 536/25

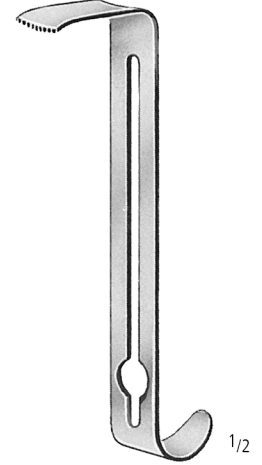

32 mm x 16 mm
AK 536/32

31,0 cm/12 1/4" 4 x 4
 33,0 cm/13" 4 x 5

 **AK 566/31**
AK 568/33

 **AK 567/31**
AK 569/33

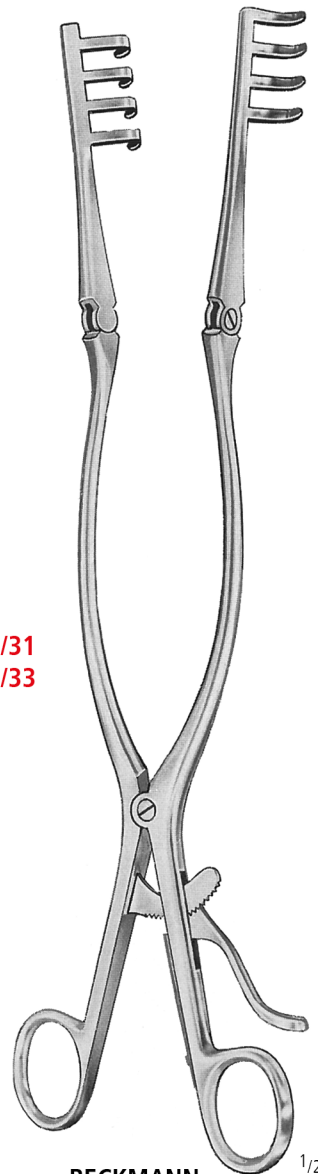

BECKMANN

WUNDHAKEN RETRACTORS SEPARADORES ECARTEURS DIVARICATORI

Selbsthaltende Wundsperrer
Selfretaining retractors
Separadores autoestaticos
Ecarteurs autostatiques
Divaricatori autostatici

AA

AB

AC

AD

AE

AF

AK

KA

KA
arthro

X

KYE

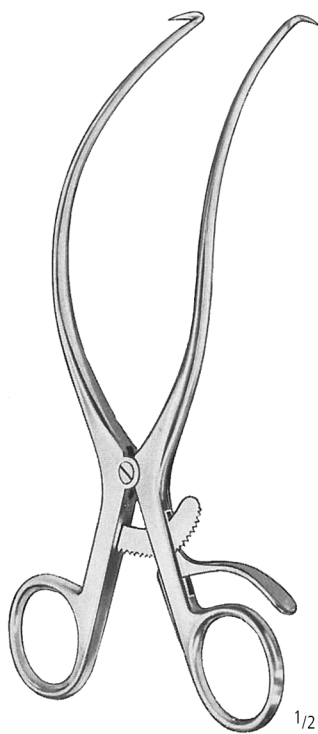

1/2

GELPI

- 9,0 cm/3 1/2" **AK 580/09**
- 11,0 cm/4 1/3" **AK 580/11**
- 14,0 cm/5 1/2" **AK 580/14**
- 19,0 cm/7 1/2" **AK 580/19**

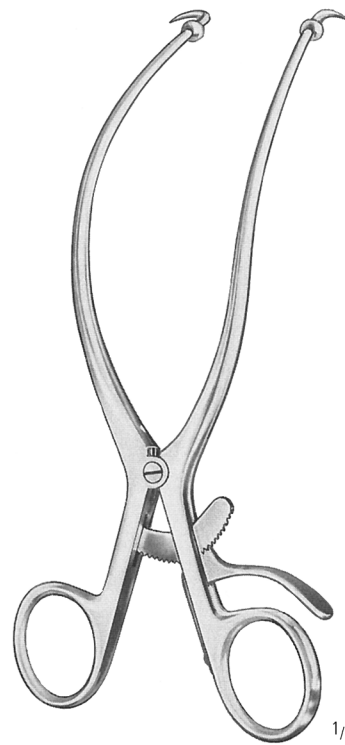

1/2

GELPI

- AK 581/19**
- 19,0 cm/7 1/2"

Knochenhebel
 Bone Levers
 Elevadores para huesos
 Leviers à os
 Elevatori per ossa

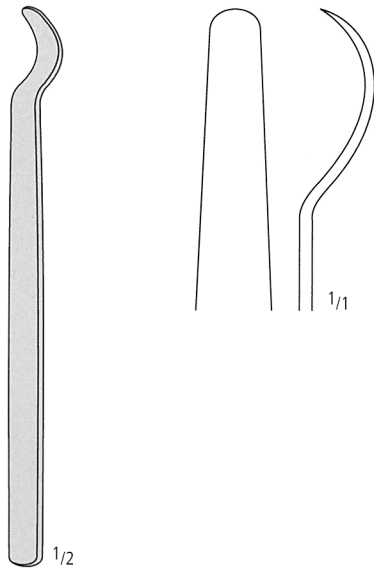

KA 170/00
 14,0 cm/5½"

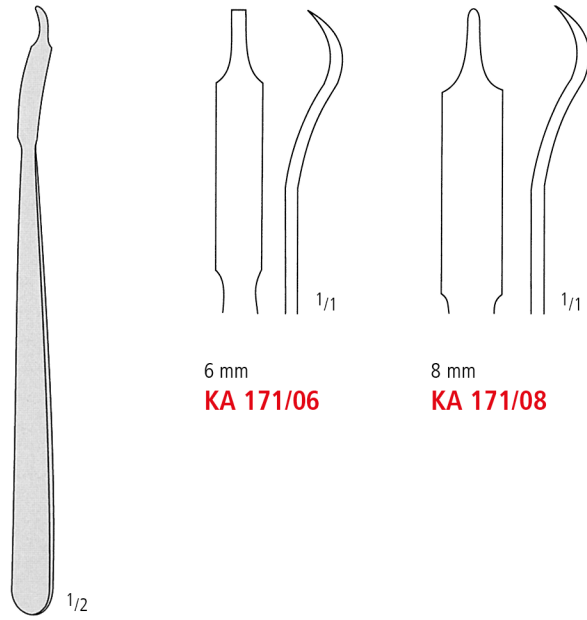

MINI-HOHMANN
 16,0 cm/6¼"

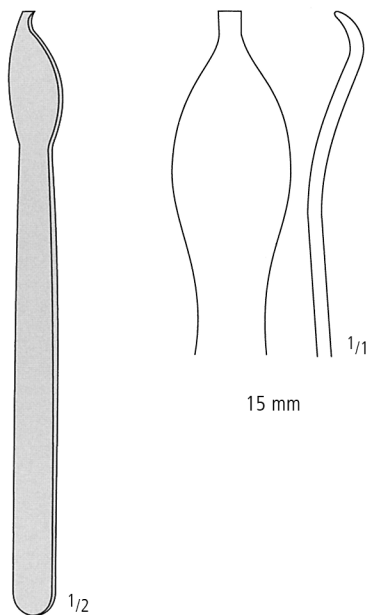

KA 171/15
 17,0 cm/6¾"

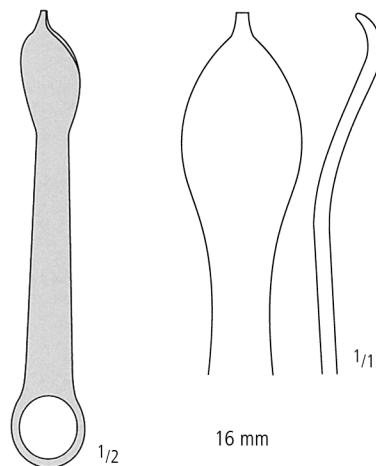

KA 171/16
 12,0 cm/4¾"

ORTHOPÄDIE ORTHOPAEDIC ORTOPEDIA ORTHOPEDIE ORTOPEDIA

Knochenhebel
 Bone Levers
 Elevadores para huesos
 Leviers à os
 Elevatori per ossa

AA
 AB
 AC
 AD
 AE
 AF
 AK
KA
 KA
 arthro
 X
 KYE

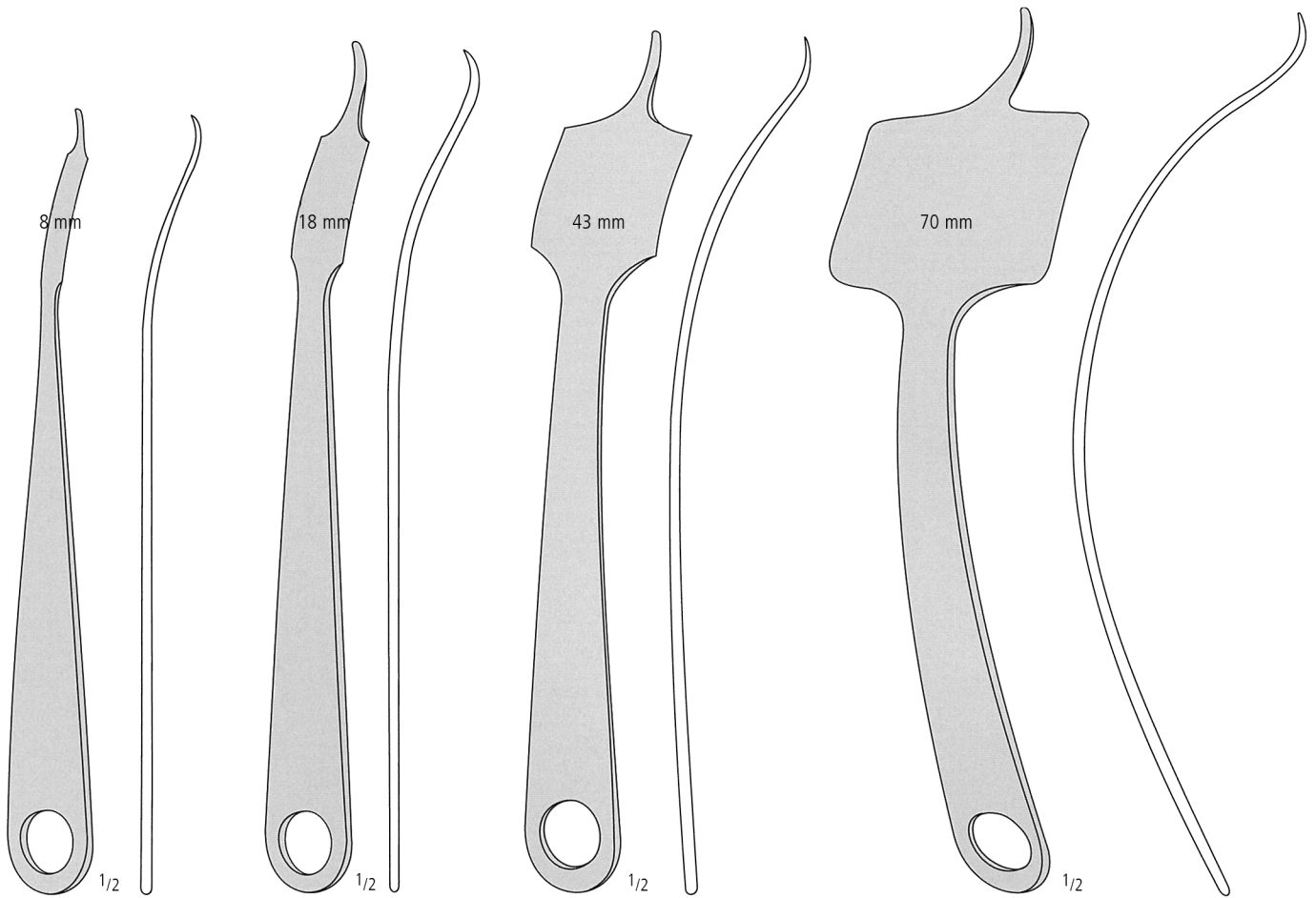

HOHMANN
KA 172/08
 22,0 cm/8³/₄"

HOHMANN
KA 172/18
 24,0 cm/9¹/₂"

HOHMANN
KA 172/43
 26,0 cm/10¹/₄"

HOHMANN
KA 172/70
 29,0 cm/11¹/₂"

Knochenhebel
 Bone Levers
 Elevadores para huesos
 Leviers à os
 Elevatori per ossa

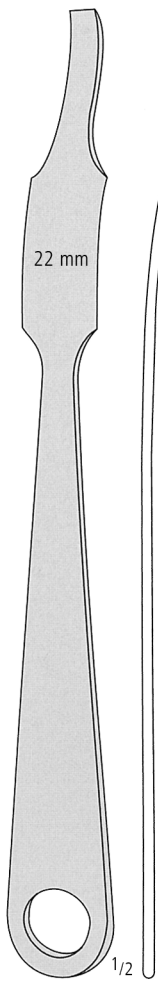

HOHMANN
KA 173/22
 25,0 cm/9³/₄"

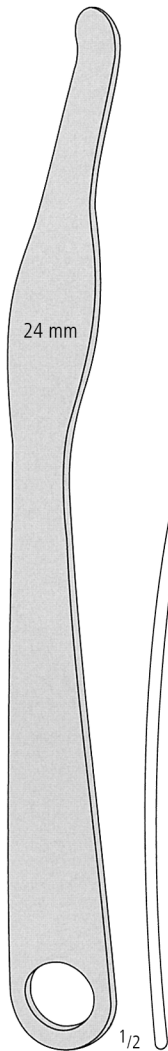

HOHMANN
KA 173/24
 28,0 cm/11"

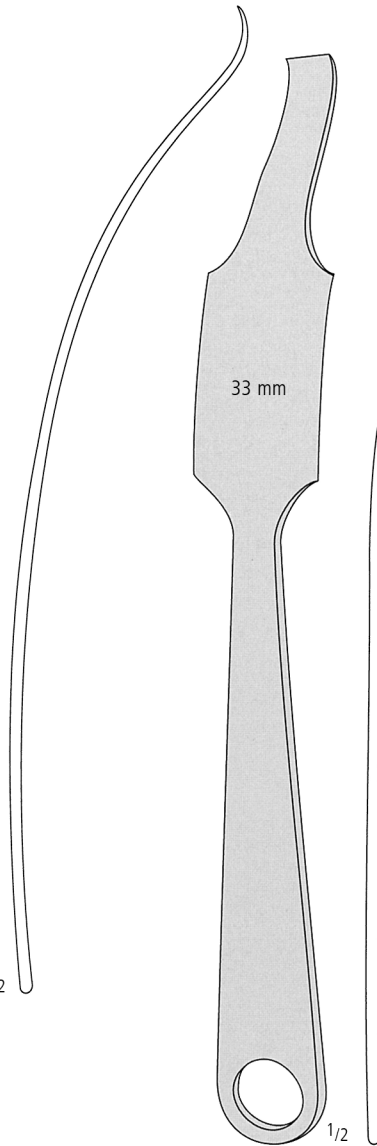

HOHMANN
KA 173/35
 29,0 cm/11¹/₂"

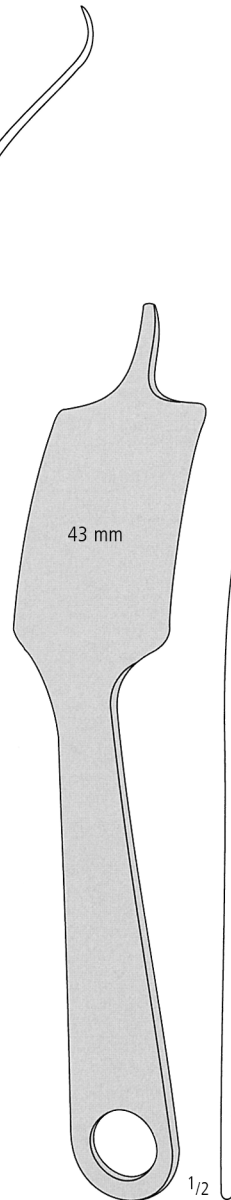

HOHMANN
KA 173/43
 25,0 cm/9³/₄"

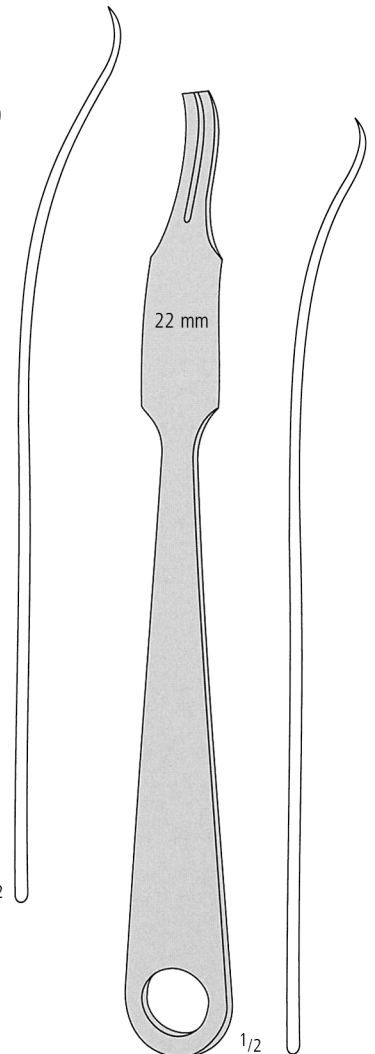

LANGE-HOHMANN
KA 174/22
 26,0 cm/10¹/₄"

Knochenhebel
 Bone Levers
 Elevadores para huesos
 Leviers à os
 Elevatori per ossa

AA

AB

AC

AD

AE

AF

AK

KA

KA
arthro

X

KYE



1/3

BLOUNT
KA 175/26
 26,0 cm/10 1/4"

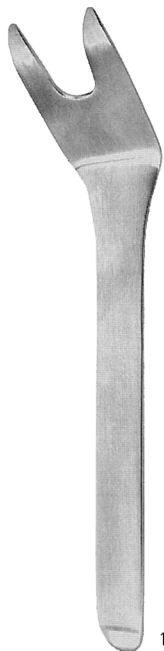

1/3

BLOUNT
KA 176/26
 26,0 cm/10 1/4"

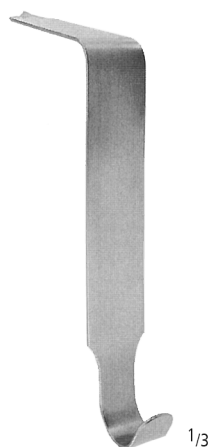

1/3

TAYLOR
 16,5 cm/6 1/2"

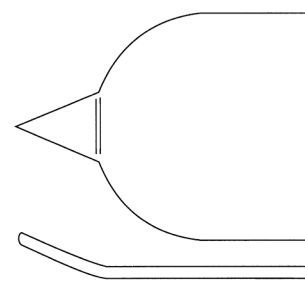

KA 177/01
 75 x 30 mm

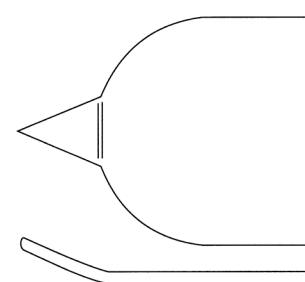

KA 177/02
 100 x 30 mm

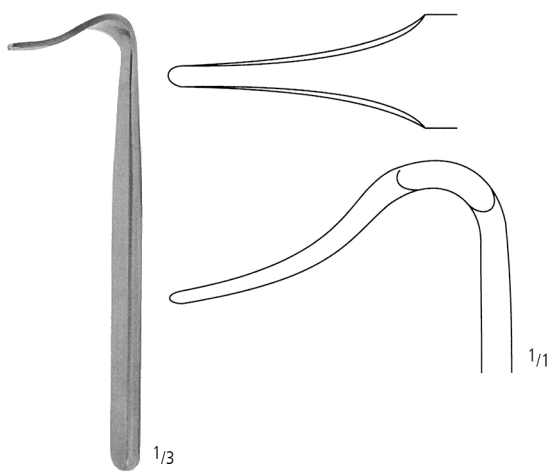

1/3

1/1

BLOUNT
KA 177/17
 17,5 cm/7"

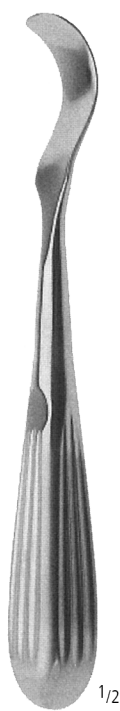

1/2

CREGO
KA 178/01
 19,0 cm/7 1/2"

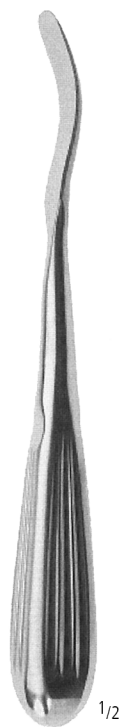

1/2

CREGO
KA 178/02
 19,0 cm/7 1/2"

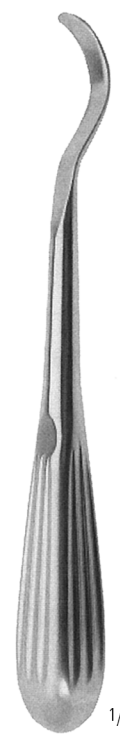

1/2

CREGO
KA 178/03
 19,0 cm/7 1/2"



1/2

CREGO
KA 178/04
 19,0 cm/7 1/2"

KA ORTHOPÄDIE ORTHOPAEDIC ORTOPEDIA ORTHOPEDIE ORTOPEDIA

Drahtzangen, Meißel und Osteotome
 Wire forceps, chisels, gouges and osteotomes
 Pinzas para hilos, cinceles y gubias
 Pincas à fil, ciseaux-burins et ostéotomes
 Tenaglie fili, scalpelli, osteotomi, sgorbie

nopa®
TUE



für weiche Drähte bis 2,0 mm Ø
 for soft wires up to 2,0 mm Ø
 para hilos blandos hasta 2,0 mm de Ø
 pour fils mous jusqu'à 2,0 mm de Ø
 per fili morbidi sino a mm 2,0 di Ø

für harte Drähte bis 1,6 mm Ø
 for hard wires up to 1,6 mm Ø
 para hilos duros hasta 1,6 mm de Ø
 pour fils durs jusqu'à 1,6 mm de Ø
 per fili duri sino a mm 1,6 di Ø

KA 273/17
 17,0 cm/6¾"

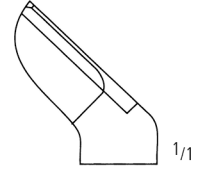

für Drähte bis 2,5 mm Ø
 for wires up to 2,5 mm Ø
 para hilos hasta 2,5 mm de Ø
 pour fils jusqu'à 2,5 mm de Ø
 per fili sino a mm 2,5 di Ø

KA 273/22
 22 cm/8¾"



ALEXANDER
 18,0 cm/7"

- mm
- 4
- 6
- 8
- 10
- 12
- 14

- KA 418/04**
- KA 418/06**
- KA 418/08**
- KA 418/10**
- KA 418/12**
- KA 418/14**



ALEXANDER
 18,0 cm/7"

- mm
- 4
- 6
- 8
- 10
- 12
- 14

- KA 419/04**
- KA 419/06**
- KA 419/08**
- KA 419/10**
- KA 419/12**
- KA 419/14**

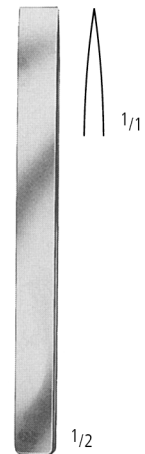

MINI-LAMBOTTE
 12,5 cm/5"

- mm
- 3
- 4
- 6
- 8
- 10
- 12
- 15

- KA 480/03**
- KA 480/04**
- KA 480/06**
- KA 480/08**
- KA 480/10**
- KA 480/12**
- KA 480/15**

MINI-LAMBOTTE
 17,0 cm/6¾"

- KA 481/03**
- KA 481/04**
- KA 481/06**
- KA 481/08**
- KA 481/10**
- KA 481/12**
- KA 481/15**

ORTHOPÄDIE ORTHOPAEDIC ORTOPEDIA ORTHOPEDIE ORTOPEDIA

Hämmer
Mallets
Martillos
Marteaux
Martelli

AA

AB

AC

AD

AE

AF

AK

KA

KA
arthro

X

KYE

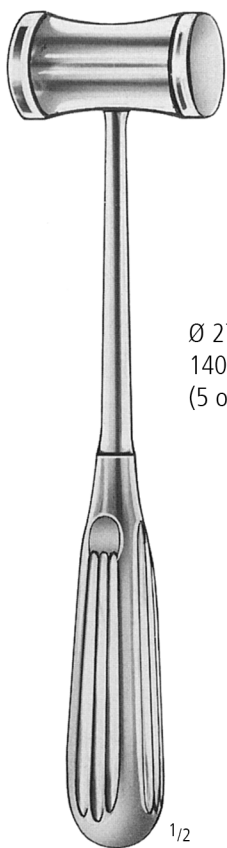

Ø 27 mm
140 g
(5 oz.)

HAJEK
KA 533/14
22,0 cm/8³/₄"

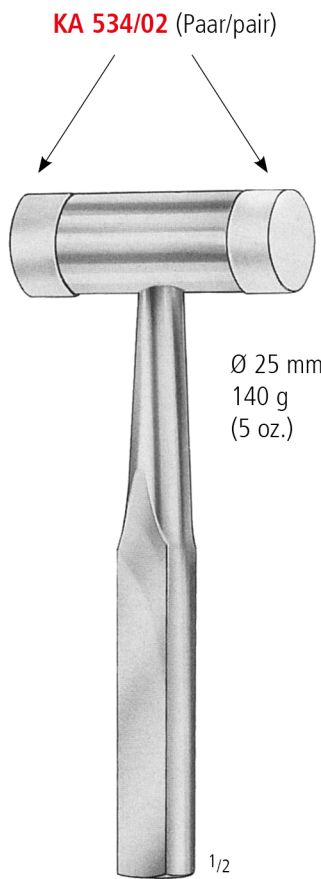

KA 534/02 (Paar/pair)

Ø 25 mm
140 g
(5 oz.)

KA 534/14
18,0 cm/7"

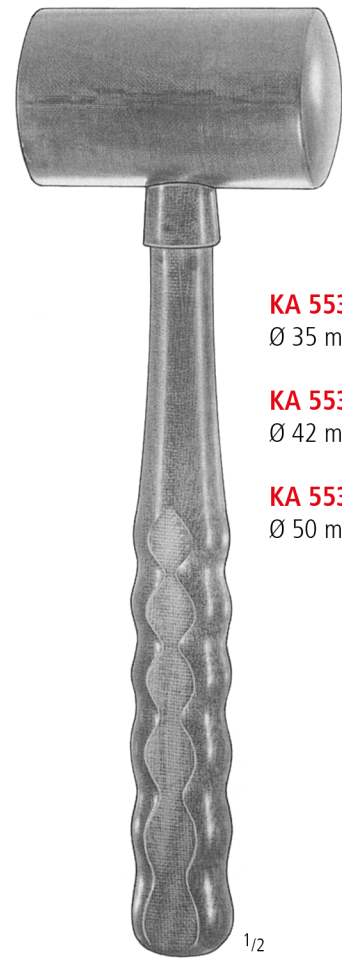

KA 553/35
Ø 35 mm

KA 553/42
Ø 42 mm

KA 553/50
Ø 50 mm

25,0 cm/10"

Knochenhaltezangen
 Bone Holding Forceps
 Pinzas para huesos
 Daviers porte-os
 Tenaglie per ossa

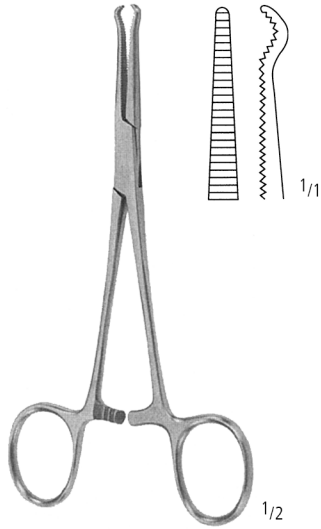

KA 730/00
 14,0 cm/5½"



KA 731/00
 13,5 cm/5¼"



KA 732/00
 12,0 cm/4¾"

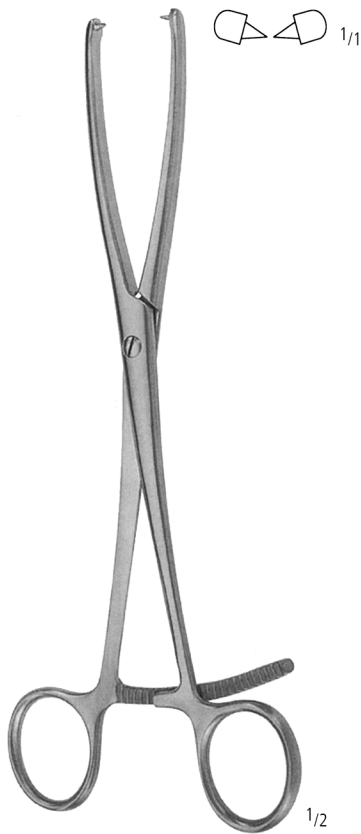

KA 747/21
 21,0 cm/8¼"

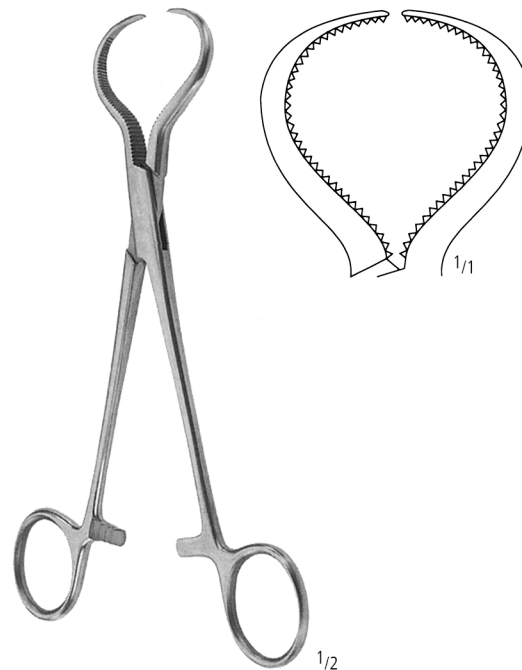

LEWIN
KA 750/17
 17,5 cm/7"

ORTHOPÄDIE ORTHOPAEDIC ORTOPEDIA ORTHOPEDIE ORTOPEDIA

Meniskus- und Knorpelfasszangen
 Meniscus- and cartilage forceps
 Pinzas para cartilago y menisco
 Daviers à ménisques et cartilage
 Pinze per afferrare menisci e cartilagine

AA
 AB
 AC
 AD
 AE
 AF
 AK
KA
 KA
 X
 KYE

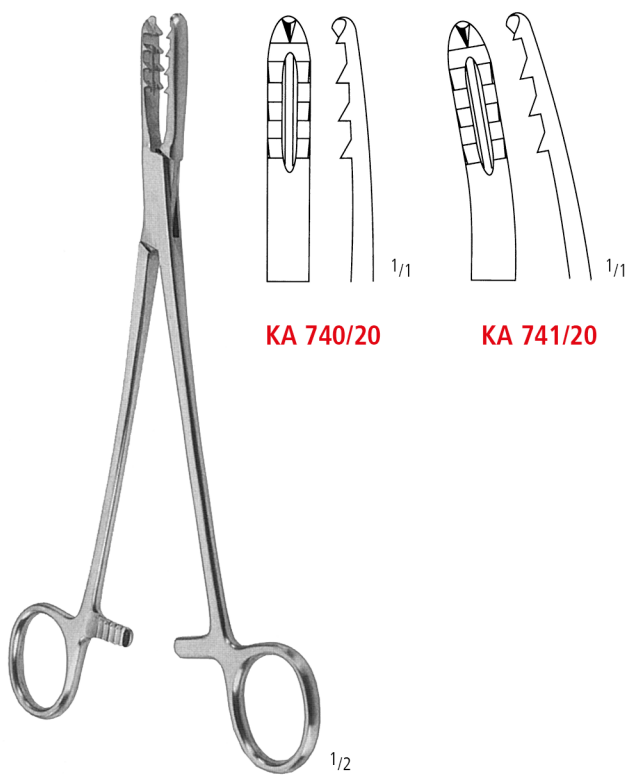

KA 740/20

KA 741/20

BIRCHER-GANSKE
 20,0 cm/8"

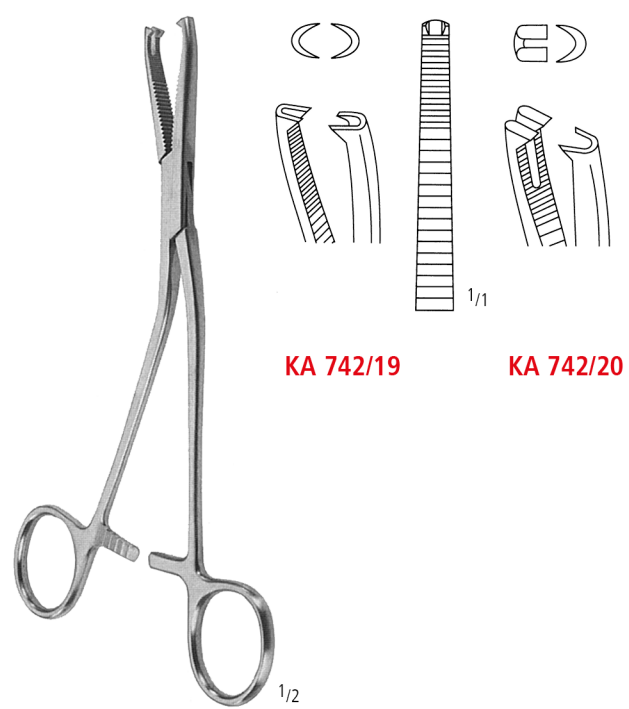

KA 742/19

KA 742/20

DINGMANN
 19,0 cm/7 1/2"



MARTIN
KA 744/19
 19,0 cm/7 1/2"



KA 745/13
 13,5 cm/5 1/4"

Sehnenfassinstrumente
 Tendon seizing instruments
 Instrumentos para coger tendones
 Instruments pour saisir les tendons
 Strumenti per afferrare tendini



KA 785/15
 15,0 cm/6"

BRAND

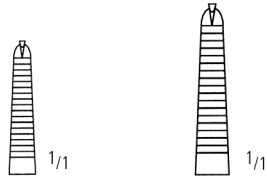

KA 785/19
 19,0 cm/7½"

KA 785/24
 24,0 cm/9½"



CAROLL
KA 786/11
 11,0 cm/4"

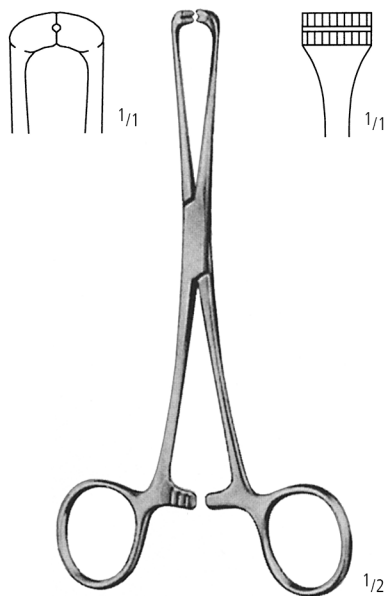

STEINMANN
KA 787/16
 16,0 cm/6¼"



KLEINERT-KUTZ
KA 788/20
 20,0 cm/8"

ORTHOPÄDIE ORTHOPAEDIC ORTOPEDIA ORTHOPEDIE ORTOPEDIA

Wund- und Meniskushaken
 Knee Retractors
 Separadores para rodilla
 Ecarteurs pour le genou
 Divaricatori per il ginocchio

AA

AB

AC

AD

AE

AF

AK

KA

KA
arthro

X

KYE

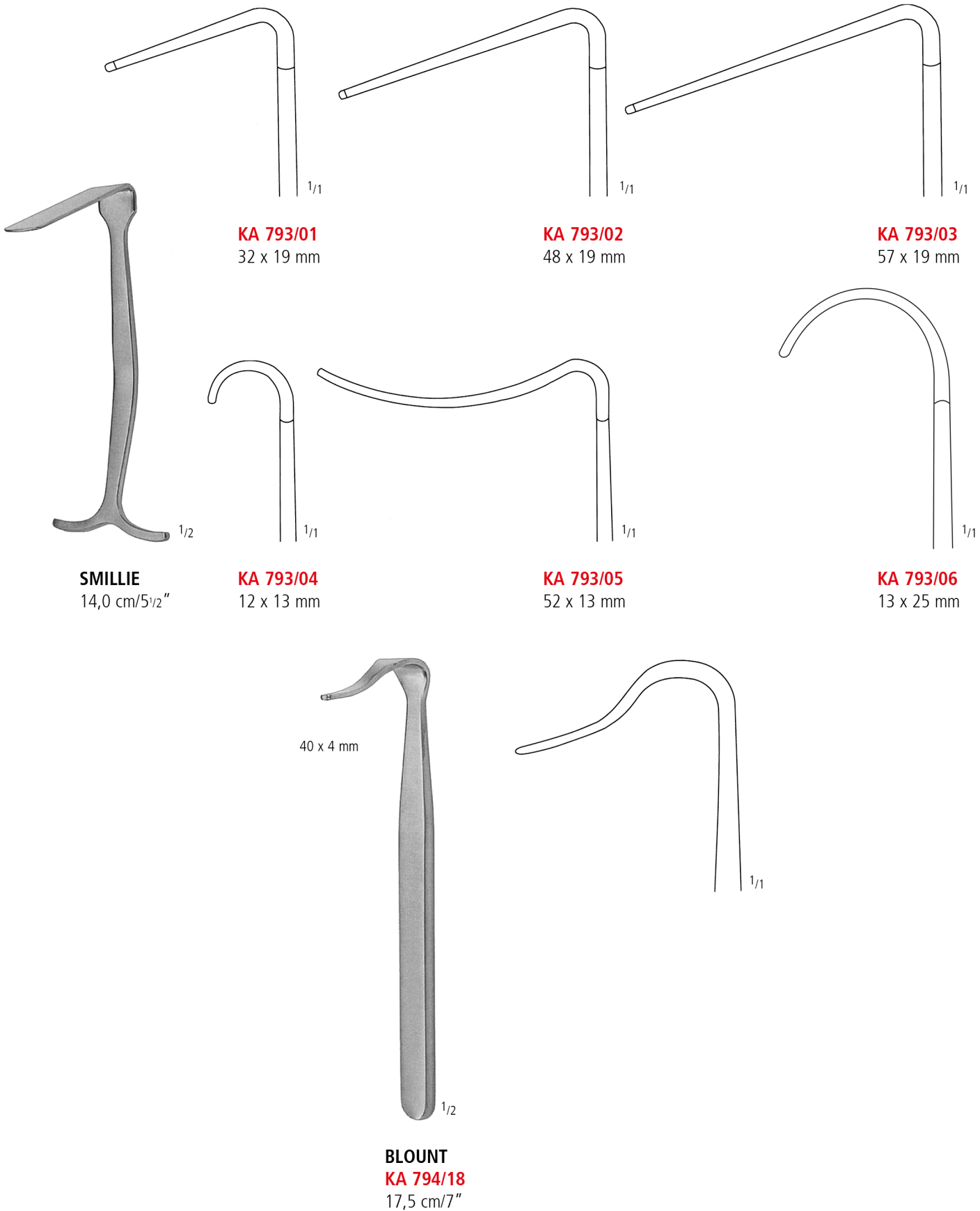

KA 793/01
32 x 19 mm

KA 793/02
48 x 19 mm

KA 793/03
57 x 19 mm

SMILLIE
14,0 cm/5½"

KA 793/04
12 x 13 mm

KA 793/05
52 x 13 mm

KA 793/06
13 x 25 mm

40 x 4 mm

BLOUNT
KA 794/18
17,5 cm/7"

Hohlmeisselzangen
 Bone rongeurs
 Pinzas gubias
 Pincis-gouges
 Pinze-sgorbie



LEMPERT
KA 816/19
 19,0 cm/7 1/2"



MARQUARDT
KA 821/20
 20,0 cm/8"

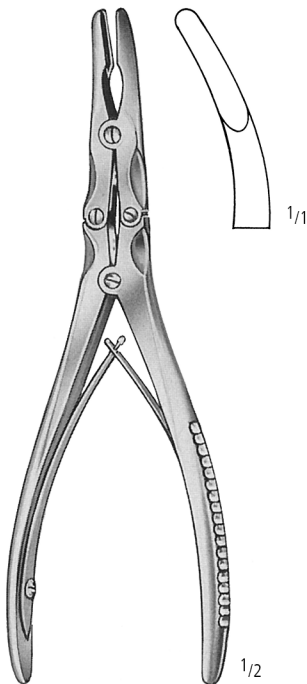

BEYER
KA 830/18
 18,0 cm/7"

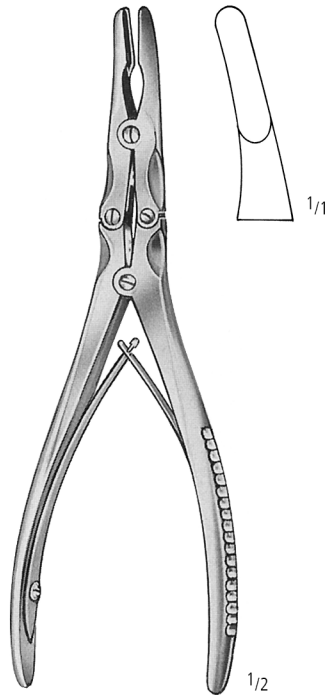

ZAUFAL-JANSEN
KA 835/18
 18,0 cm/7"

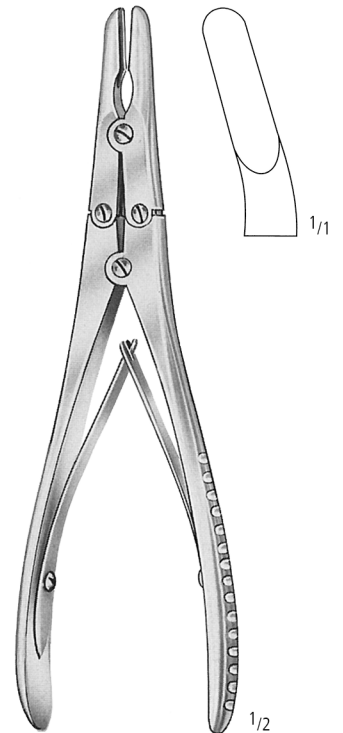

RUSKIN
KA 836/18
 18,0 cm/7"

ORTHOPÄDIE ORTHOPAEDIC ORTOPEDIA ORTHOPEDIE ORTOPEDIA

Knochensplitterzangen
 Bone cutting forceps
 Pinzas cortantes para huesos
 Pincas coupantes à os
 Cesoie per ossa

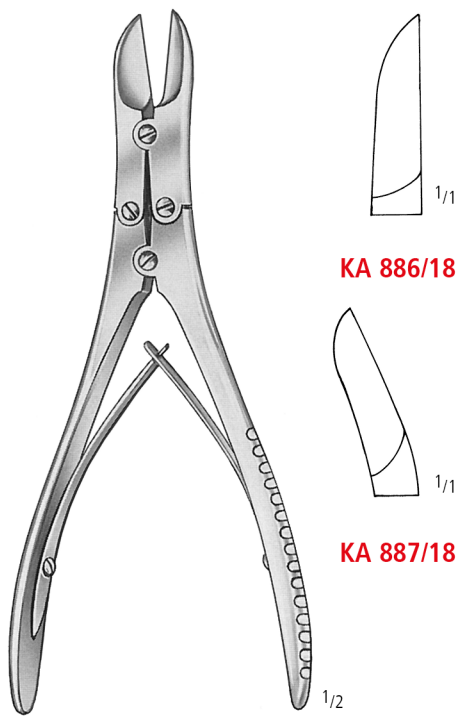

KA 886/18

KA 887/18

RUSKIN-LISTON
 18,5 cm/7¼"

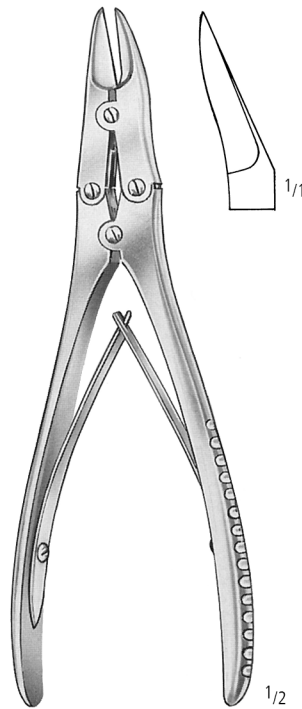

MC INDOE
KA 888/17
 17,5 cm/7"

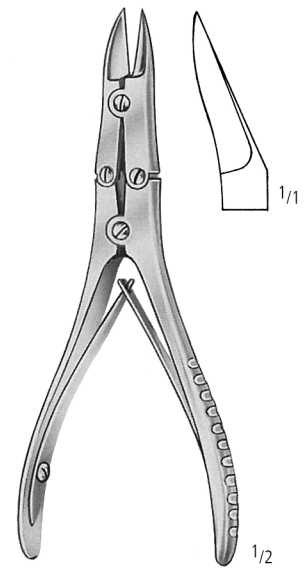

WALTON-LISTON
KA 889/01
 15,0 cm/6"

AA

AB

AC

AD

AE

AF

AK

KA

KA
arthro

X

KYE



ARTHROSKOPIE
 ARTHROSCOPY
 ARTROSCOPIA
 ARTHROSCOPIE
 ARTROSCOPIA

KA

traditional

>> economical

modern

>> valuable
 >> affordable
 >> pinless instruments
 >> basic & advanced line

Handgriff-Instrumente	Seite	46-50
Handgrip instruments	Page	46-50
Instrumentos con mango	Página	46-50
Instruments avec poignées	Page	46-50
Strumenti con manico	Pagina	46-50

Stanzen, Scheren, Fasszangen	Seite	52-55
Punches, scissors, grasping forceps	Page	52-55
Punzones, tijeras, pinzas de agarre	Página	52-55
Pinces emporte-pièces, ciseaux, pinces à préhension	Page	52-55
Pinze, forbici, pinze da presa	Pagina	52-55

Knie-Instrumente	Seite	61-79
Knee instruments	Page	61-79
Instrumentos de rodilla	Página	61-79
Instruments pour le genou	Page	61-79
Strumenti per il ginocchio	Pagina	61-79

Kleingelenk-Instrumente	Seite	81-87
Small joint instruments	Page	81-87
Instrumentos de articulación pequeña	Página	81-87
Instruments pour les petites articulations	Page	81-87
Strumenti per le piccole articolazioni	Pagina	81-87

Schulter-Instrumente	Seite	89-109
Shoulder instruments	Page	89-109
Instrumentos de hombro	Página	89-109
Instruments pour l'épaule	Page	89-109
Strumenti per la spalla	Pagina	89-109

Hüft-Instrumente	Seite	111-118
Hip instruments	Page	111-118
Instrumentos de cadera	Página	111-118
Instruments pour la hanche	Page	111-118
Strumenti per l'anca	Pagina	111-118



KA ARTHROSKOPIE ARTHROSCOPY ARTROSCOPIA ARTHROSCOPIE ARTROSCOPIA

Instrumente mit Rändelgriff
 Instruments with knurled handle
 Instrumentos con mango moleteado
 Instruments avec poignée moletée
 Strumenti con manico zigrinato



**Instrumente mit Rändelgriff
 instruments with knurled handle**

	Hakenmesser, 3,0 mm hook knife, 3.0 mm	KA 300/01
	Meniskotom, 5,0 mm meniscotome, 5.0 mm	KA 300/02
	Messer 45° knife 45°	KA 300/03
	Bananenmesser, glatt banana knife, smooth	KA 300/04
	Skalpelmesser scalpel-knife	KA 300/05
	Hakensonde, 4,0 mm hook probe, 4.0 mm	KA 300/06
	SMILLIE Meniskotom, 3,0 mm SMILLIE meniscotome, 3.0 mm	KA 300/07
	Rosettenmesser, gerade rosette knife, straight	KA 300/08
	Bananenmesser, gezahnt banana knife, serrated	KA 300/09
	Löffel, 3,0 mm, 30° abgewinkelt spoon, 3.0 mm, 30° angled	KA 300/10
	Ringkürette, 3,0 mm, 30° abgewinkelt ring curette, 3.0 mm, 30° angled	KA 300/11
	Sichelmesser sickle knife	KA 300/12
	SMILLIE Meniskotom, 7,0 mm SMILLIE meniscotome, 7.0 mm	KA 300/17
	Hakensonde, 2,5 mm, graduiert hook probe, 2.5 mm, graduated	KA 300/18
	Hakensonde, 3,5 mm, graduiert hook probe, 3.5 mm, graduated	KA 300/19
	Knorpelfeile, fein cartilage rasp, fine	KA 300/30
	Knorpelfeile, grob cartilage rasp, heavy	KA 300/31

1/1

ARTHROSKOPIE ARTHROSCOPY ARTROSCOPIA ARTHROSCOPIE ARTROSCOPIA

Instrumente mit Dreieck-Griff
 Instruments with triangular handle
 Instrumentos con mango triangular
 Instruments avec poignée triangulaire
 Strumenti con manico triangolare

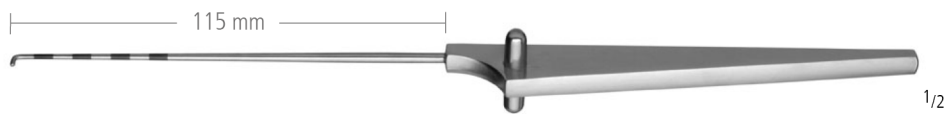

**Instrumente mit Dreieckgriff
 instruments with triangular handle**

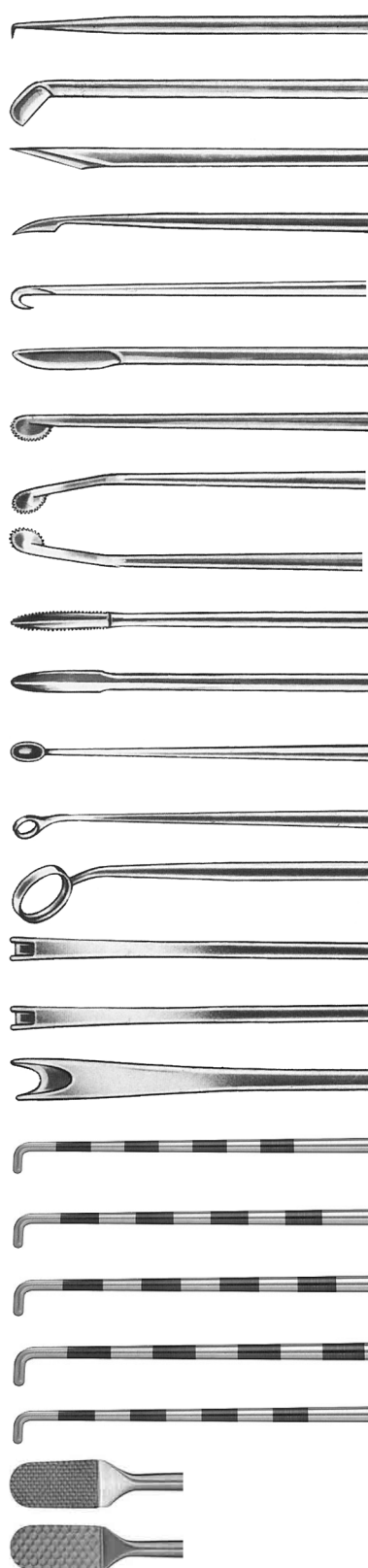

	Hakensonde, spitz hook probe, pointed	KA 301/01
	Messer 45°, retrograd knife 45°, retrograde	KA 301/02
	Bajonettmesser bayonet knife	KA 301/03
	Sichelmesser sickle knife	KA 301/04
	Hakenmesser, 3,0 mm hook knife, 3.0 mm	KA 301/05
	Skalpelmesser scalpel knife	KA 301/06
	Rosettenmesser, gerade rosette knife, straight	KA 301/07
	Rosettenmesser, Schaft 30° links gebogen rosette knife, shaft 30° curved left	KA 301/08
	Rosettenmesser, Schaft 30° rechts gebogen rosette knife, shaft 30° curved right	KA 301/09
	Bananenmesser, gezahnt banana knife, serrated	KA 301/10
	Bananenmesser, glatt banana knife, smooth	KA 301/11
	Löffel, 3,0 mm, 30° abgewinkelt spoon, 3.0 mm, 30° angled	KA 301/12
	Ringkürette, 3,0 mm, 30° abgewinkelt ring curette, 3.0 mm, 30° angled	KA 301/13
	Ringkürette, 7,0 mm, 30° abgewinkelt ring curette, 7.0 mm, 30° angled	KA 301/14
	SMILLIE Meniskotom, 3,0 mm SMILLIE meniscotome, 3.0 mm	KA 301/15
	SMILLIE Meniskotom, 5,0 mm SMILLIE meniscotome, 5.0 mm	KA 301/16
	SMILLIE Meniskotom, 7,0 mm SMILLIE meniscotome, 7.0 mm	KA 301/17
	Hakensonde, 2,5 mm, graduert hook probe, 2.5 mm, graduated	KA 301/18
	Hakensonde, 3,5 mm, graduert hook probe, 3.5 mm, graduated	KA 301/19
	Hakensonde, 4,0 mm, graduert hook probe, 4.0 mm, graduated	KA 301/20
	Hakensonde, 5,0 mm, graduert hook probe, 5.0 mm, graduated	KA 301/21
	Hakensonde, 3,0 mm, graduert hook probe, 3.0 mm, graduated	KA 301/22
	Knorpelfeile, fein cartilage rasp, fine	KA 301/30
	Knorpelfeile, grob cartilage rasp, heavy	KA 301/31

KA ARTHROSKOPIE ARTHROSCOPY ARTROSCOPIA ARTHROSCOPIE ARTROSCOPIA

Instrumente mit auswechselbaren Einsätzen
 Instruments with interchangeable inserts
 Instrumentos con insertos intercambiables
 Instruments avec inserts interchangeables
 Strumenti con inserti intercambiabili

*längenverstellbar
 adjustable in length*

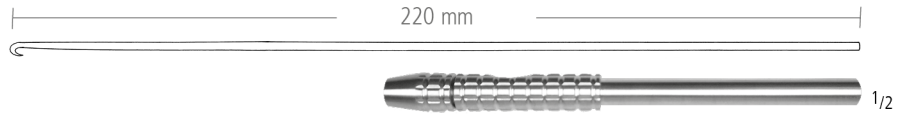

**Instrumente mit auswechselbaren Einsätzen, längenverstellbar
 instruments with interchangeable inserts, adjustable in length**

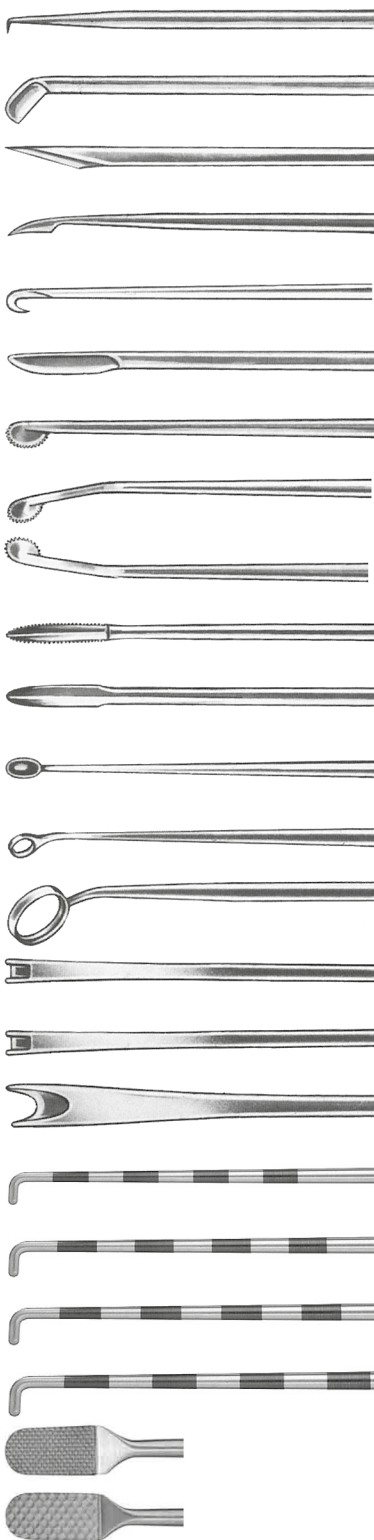

Griff allein, 125 mm handle only, 125 mm	KA 302/00
Hakensonde, spitz hook probe, pointed	KA 302/01
Messer 45°, retrograd knife 45°, retrograde	KA 302/02
Bajonettmesser bajonet knife	KA 302/03
Sichelmesser sickle knife	KA 302/04
Hakenmesser, 3,0 mm hook knife, 3.0 mm	KA 302/05
Skalpelmesser scalpel knife	KA 302/06
Rosettenmesser, gerade rosette knife, straight	KA 302/07
Rosettenmesser, 30° links gebogen rosette knife, 30° curved left	KA 302/08
Rosettenmesser, 30° rechts gebogen rosette knife, 30° curved right	KA 302/09
Bananenmesser, gezahnt banana knife, serrated	KA 302/10
Bananenmesser, glatt banana knife, smooth	KA 302/11
Löffel, 3,0 mm, 30° abgewinkelt spoon, 3.0 mm, 30° angled	KA 302/12
Ringkürette, 3,0 mm, 30° abgewinkelt ring curette, 3.0 mm, 30° angled	KA 302/13
Ringkürette, 7,0 mm, 30° abgewinkelt ring curette, 7.0 mm, 30° angled	KA 302/14
SMILLIE Meniskotom, 3,0 mm SMILLIE meniscotome, 3.0 mm	KA 302/15
SMILLIE Meniskotom, 5,0 mm SMILLIE meniscotome, 5.0 mm	KA 302/16
SMILLIE Meniskotom, 7,0 mm SMILLIE meniscotome, 7.0 mm	KA 302/17
Hakensonde, 2,5 mm, graduiert hook probe, 2.5 mm, graduated	KA 302/18
Hakensonde, 3,5 mm, graduiert hook probe, 3.5 mm, graduated	KA 302/19
Hakensonde, 4,0 mm, graduiert hook probe, 4.0 mm, graduated	KA 302/20
Hakensonde, 5,0 mm, graduiert hook probe, 5.0 mm, graduated	KA 302/21
Knorpelfeile, fein cartilage rasp, fine	KA 302/30
Knorpelfeile, grob cartilage rasp, heavy	KA 302/31

ARTHROSKOPIE ARTHROSCOPY ARTROSCOPIA ARTHROSCOPIE ARTROSCOPIA

Instrumente mit auswechselbaren Aufsätzen
 Instruments with interchangeable inserts
 Instrumentos con insertos intercambiables
 Instruments avec inserts interchangeables
 Strumenti con inserti intercambiabili

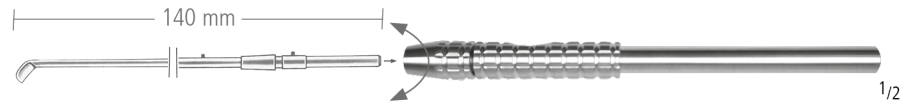

**Instrumente mit auswechselbaren Aufsätzen
 instruments with interchangeable inserts**

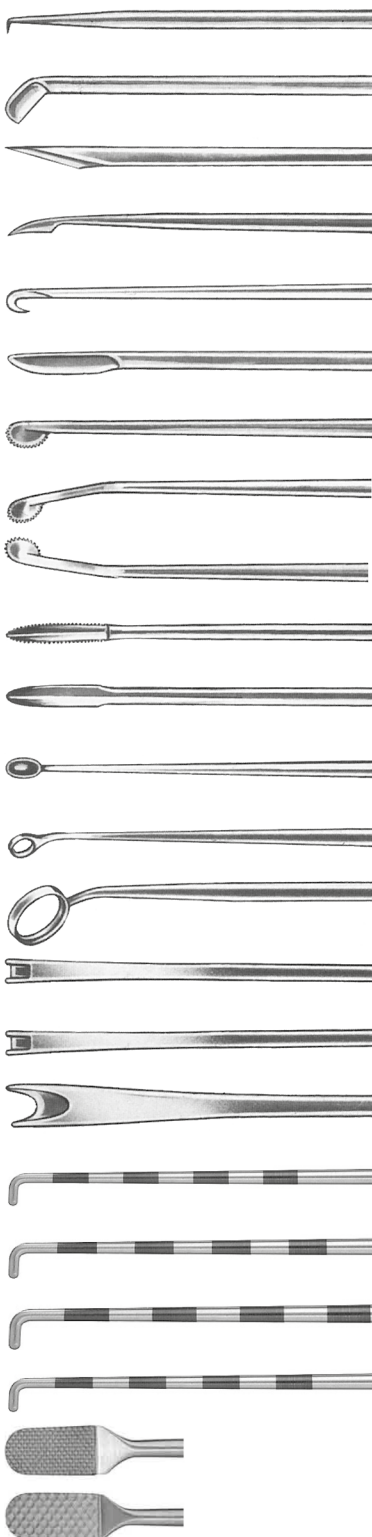

Griff allein, 125 mm handle only, 125 mm	KA 304/00
Hakensonde, spitz hook probe, pointed	KA 304/01
Messer 45°, retrograd knife 45°, retrograde	KA 304/02
Bajonettmesser bajonet knife	KA 304/03
Sichelmesser sickle knife	KA 304/04
Hakenmesser, 3,0 mm hook knife, 3.0 mm	KA 304/05
Skalpelmesser scalpel knife	KA 304/06
Rosettenmesser, gerade rosette knife, straight	KA 304/07
Rosettenmesser, 30° links gebogen rosette knife, 30° curved left	KA 304/08
Rosettenmesser, 30° rechts gebogen rosette knife, 30° curved right	KA 304/09
Bananenmesser, gezahnt banana knife, serrated	KA 304/10
Bananenmesser, glatt banana knife, smooth	KA 304/11
Löffel, 3,0 mm, 30° abgewinkelt spoon, 3.0 mm, 30° angled	KA 304/12
Ringkürette, 3,0 mm, 30° abgewinkelt ring curette, 3.0 mm, 30° angled,	KA 304/13
Ringkürette, 7,0 mm, 30° abgewinkelt ring curette, 7.0 mm, 30° angled	KA 304/14
SMILLIE Meniskotom, 3,0 mm SMILLIE meniscotome, 3.0 mm	KA 304/15
SMILLIE Meniskotom, 5,0 mm SMILLIE meniscotome, 5.0 mm	KA 304/16
SMILLIE Meniskotom, 7,0 mm SMILLIE meniscotome, 7.0 mm	KA 304/17
Hakensonde, 2,5 mm, graduiert hook probe, 2.5 mm, graduated	KA 304/18
Hakensonde, 3,5 mm, graduiert hook probe, 3.5 mm, graduated	KA 304/19
Hakensonde, 5,0 mm, graduiert hook probe, 5.0 mm, graduated	KA 304/21
Hakensonde, 3,0 mm, graduiert hook probe, 3.0 mm, graduated	KA 304/22
Knorpelfeile, fein cartilage rasp, fine	KA 304/30
Knorpelfeile, grob cartilage rasp, heavy	KA 304/31

AA
AB
AC
AD
AE
AF
AK
KA
X
KYE

KA
arthro

Mikrofraktur-Instrumente, Knotenschieber
 Microfracture instruments, knot pusher
 Instrumentos de microfractura, pasanudo
 Instruments pour les microfractures, pousse-noeuds
 Strumenti per microfrattura, spingichiodi



Chondro Picks Ø 6 mm, mit Silikongriff
chondro picks Ø 6 mm, with silicone handle

		L=125 mm	L=215 mm
	Chondro Pick, gerade chondro pick, straight	KA 306/01	KA 306/11
	Chondro Pick, Spitze gebogen 25° chondro pick, angled tip 25°	KA 306/02	KA 306/12
	Chondro Pick, Spitze gebogen 40° chondro pick, angled tip 40°	KA 306/03	KA 306/13
	Chondro Pick, Spitze gebogen 60° chondro pick, angled tip 60°	KA 306/04	KA 306/14
	Chondro Pick, Spitze gebogen 90° chondro pick, angled tip 90°	KA 306/05	KA 306/15

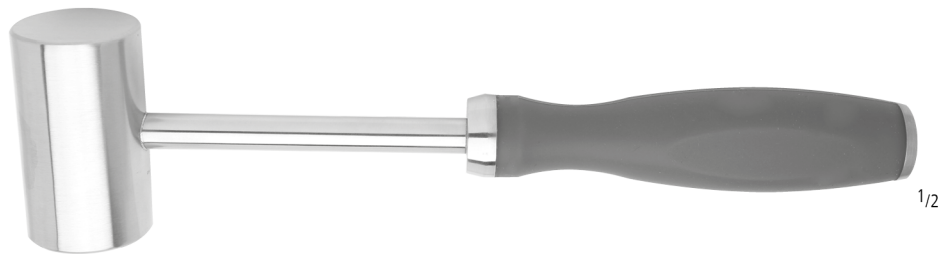

Hammer für Chondro Picks, mit Silikongriff
mallet for chondro picks, with silicone handle

Hammer Ø 35 mm, Länge 240 mm, 500 g
 mallet Ø 35 mm, length 240 mm, 500 g

KA 306/90



Knotenschieber, geschlossen, Schaft gerade
knot pusher, closed, shaft straight

L=125 mm	L=155 mm	L=220 mm
KA 307/01	KA 307/02	KA 307/03

traditional

>> economical



KNIE-INSTRUMENTE
KNEE INSTRUMENTS



KLEINGELENK-INSTRUMENTE
SMALL JOINT INSTRUMENTS

types of working ends

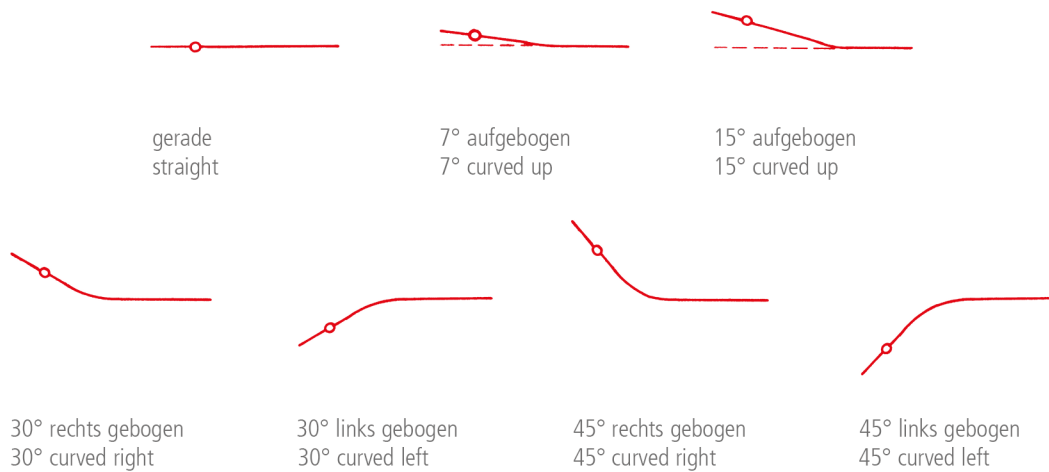

lengths of shafts

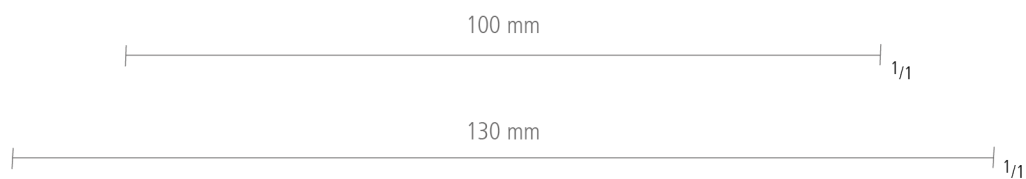

diameters of shafts



cutting width (cw) / jaw width (jw)





ARTHROSKOPIE ARTHROSCOPY ARTROSCOPIA ARTHROSCOPIE ARTROSCOPIA

Stanzen, Scheren, Fassungen
 Punches, scissors, grasping forceps
 Punzones, tijeras, pinzas de agarre
 Pinzes emporte-pièces, ciseaux, pinces à préhension
 Pinze, forbici, pinze da presa

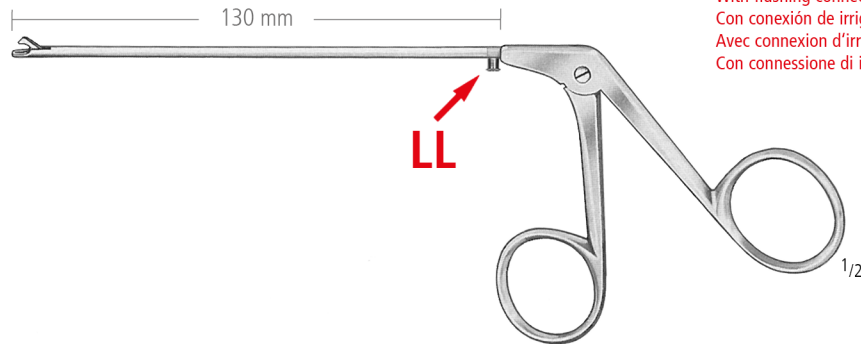

Mit Spülanschluss zur Reinigung
 With flushing connection for cleaning
 Con conexión de irrigación para la limpieza
 Avec connexion d'irrigation pour le nettoyage
 Con connessione di irrigazione

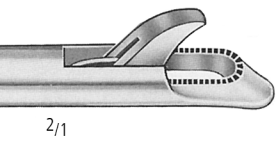

Stanze mit Schippe
 punch with shovel

2/1

	gerade straight	7° aufgebogen 7° curved up	15° aufgebogen 15° curved up	30° rechts gebogen 30° curved right	30° links gebogen 30° curved left	45° rechts gebogen 45° curved right	45° links gebogen 45° curved left
Ø 2,7 mm cw* 1,2 mm	KA 320/10	KA 320/11	KA 320/13	KA 320/15	KA 320/17	KA 320/19	KA 320/21
Ø 3,4 mm cw* 1,6 mm	KA 321/10	KA 321/11	KA 321/13	KA 321/15	KA 321/17	KA 321/19	KA 321/21
Ø 4,5 mm cw* 2,2 mm	KA 322/10	KA 322/11	KA 322/13	KA 322/15	KA 322/17	KA 322/19	KA 322/21

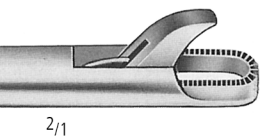

Stanze ohne Schippe
 punch without shovel

2/1

	gerade straight	7° aufgebogen 7° curved up	15° aufgebogen 15° curved up	30° rechts gebogen 30° curved right	30° links gebogen 30° curved left	45° rechts gebogen 45° curved right	45° links gebogen 45° curved left
Ø 2,7 mm cw* 1,2 mm	KA 323/10	KA 323/11	KA 323/13	KA 323/15	KA 323/17	KA 323/19	KA 323/21
Ø 3,4 mm cw* 1,6 mm	KA 324/10	KA 324/11	KA 324/13	KA 324/15	KA 324/17	KA 324/19	KA 324/21
Ø 4,5 mm cw* 2,2 mm	KA 325/10	KA 325/11	KA 325/13	KA 325/15	KA 325/17	KA 325/19	KA 325/21

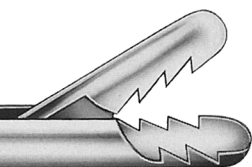

Universal-Fasszange
 universal grasper

2/1

	gerade straight	7° aufgebogen 7° curved up	15° aufgebogen 15° curved up	30° rechts gebogen 30° curved right	30° links gebogen 30° curved left	45° rechts gebogen 45° curved right	45° links gebogen 45° curved left
Ø 3,4 mm jw* 3,5 mm	KA 326/10	KA 326/11	KA 326/13	KA 326/15	KA 326/17	KA 326/19	KA 326/21

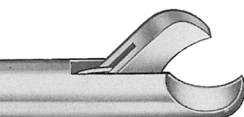

Hakenschere
 hook scissors

2/1

	gerade straight	7° aufgebogen 7° curved up	15° aufgebogen 15° curved up	30° rechts gebogen 30° curved right	30° links gebogen 30° curved left	45° rechts gebogen 45° curved right	45° links gebogen 45° curved left
Ø 3,4 mm	KA 327/10	KA 327/11	KA 327/13	KA 327/15	KA 327/17	KA 327/19	KA 327/21



ARTHROSKOPIE ARTHROSCOPY ARTROSCOPIA ARTHROSCOPIE ARTROSCOPIA

Stanzen, Scheren, Fassungen
 Punches, scissors, grasping forceps
 Punzones, tijeras, pinzas de agarre
 Pinzes emporte-pièces, ciseaux, pinces à préhension
 Pinze, forbici, pinze da presa

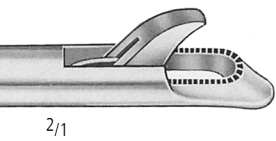
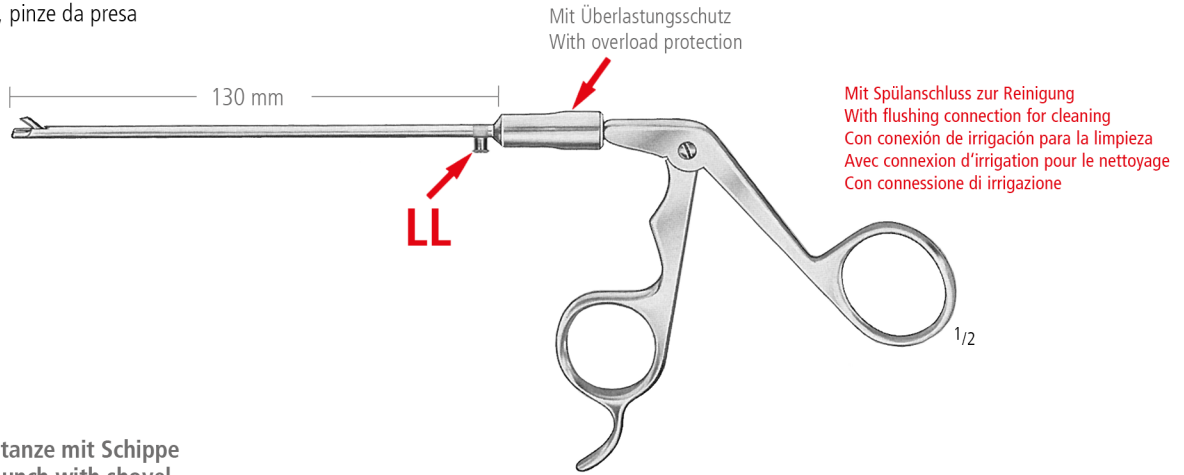

Stanze mit Schippe
 punch with shovel

2/1

	gerade straight	7° aufgebogen 7° curved up	15° aufgebogen 15° curved up	30° rechts gebogen 30° curved right	30° links gebogen 30° curved left	45° rechts gebogen 45° curved right	45° links gebogen 45° curved left
Ø 2,7 mm cw* 1,2 mm	KA 328/10	KA 328/11	KA 328/13	KA 328/15	KA 328/17	KA 328/19	KA 328/21
Ø 3,4 mm cw* 1,6 mm	KA 329/10	KA 329/11	KA 329/13	KA 329/15	KA 329/17	KA 329/19	KA 329/21
Ø 4,5 mm cw* 2,2 mm	KA 330/10	KA 330/11	KA 330/13	KA 330/15	KA 330/17	KA 330/19	KA 330/21

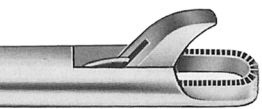

Stanze ohne Schippe
 punch without shovel

2/1

	gerade straight	7° aufgebogen 7° curved up	15° aufgebogen 15° curved up	30° rechts gebogen 30° curved right	30° links gebogen 30° curved left	45° rechts gebogen 45° curved right	45° links gebogen 45° curved left
Ø 2,7 mm cw* 1,2 mm	KA 331/10	KA 331/11	KA 331/13	KA 331/15	KA 331/17	KA 331/19	KA 331/21
Ø 3,4 mm cw* 1,6 mm	KA 332/10	KA 332/11	KA 332/13	KA 332/15	KA 332/17	KA 332/19	KA 332/21
Ø 4,5 mm cw* 2,2 mm	KA 333/10	KA 333/11	KA 333/13	KA 333/15	KA 333/17	KA 333/19	KA 333/21

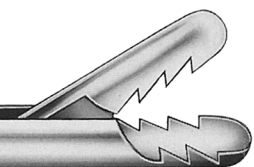

Universal-Fasszange
 universal grasper

2/1

	gerade straight	7° aufgebogen 7° curved up	15° aufgebogen 15° curved up	30° rechts gebogen 30° curved right	30° links gebogen 30° curved left	45° rechts gebogen 45° curved right	45° links gebogen 45° curved left
Ø 3,4 mm jw* 3,5 mm	KA 334/10	KA 334/11	KA 334/13	KA 334/15	KA 334/17	KA 334/19	KA 334/21

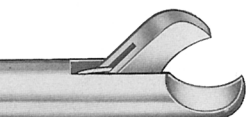

Hakenschere
 hook scissors

2/1

	gerade straight	7° aufgebogen 7° curved up	15° aufgebogen 15° curved up	30° rechts gebogen 30° curved right	30° links gebogen 30° curved left	45° rechts gebogen 45° curved right	45° links gebogen 45° curved left
Ø 3,4 mm	KA 335/10	KA 335/11	KA 335/13	KA 335/15	KA 335/17	KA 335/19	KA 335/21

*cw = cutting width

*jw = jaw width

AA

AB

AC

AD

AE

AF

AK

KA

KA
arthro

X

KYE



ARTHROSKOPIE ARTHROSCOPY ARTROSCOPIA ARTHROSCOPIE ARTROSCOPIA

Fasszangen
Grasping forceps
Pinzas de agarre
Pincas à préhension
Pinze da presa

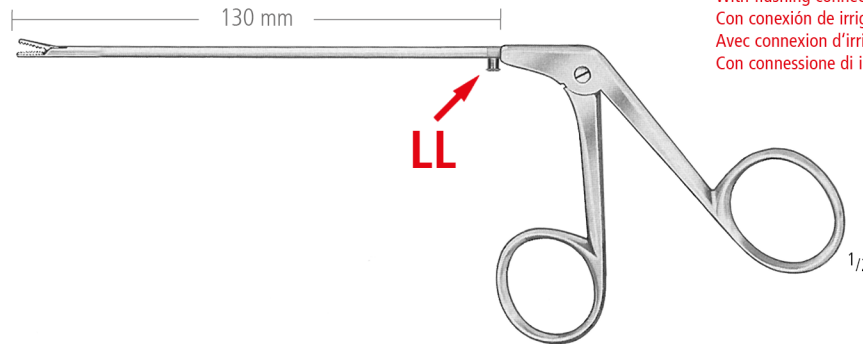

Mit Spülanschluss zur Reinigung
With flushing connection for cleaning
Con conexión de irrigación para la limpieza
Avec connexion d'irrigation pour le nettoyage
Con connessione di irrigazione

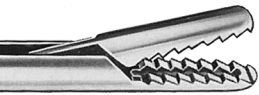

Alligator-Fasszange, Maulbreite 3,5-2,8 mm
Alligator grasping forceps, jaw width 3.5-2.8 mm

2/1

	gerade straight	7° aufgebogen 7° curved up	15° aufgebogen 15° curved up	30° rechts gebogen 30° curved right	30° links gebogen 30° curved left	45° rechts gebogen 45° curved right	45° links gebogen 45° curved left
Ø 3,4 mm	KA 339/10	KA 339/11	KA 339/13	KA 339/15	KA 339/17	KA 339/19	KA 339/21

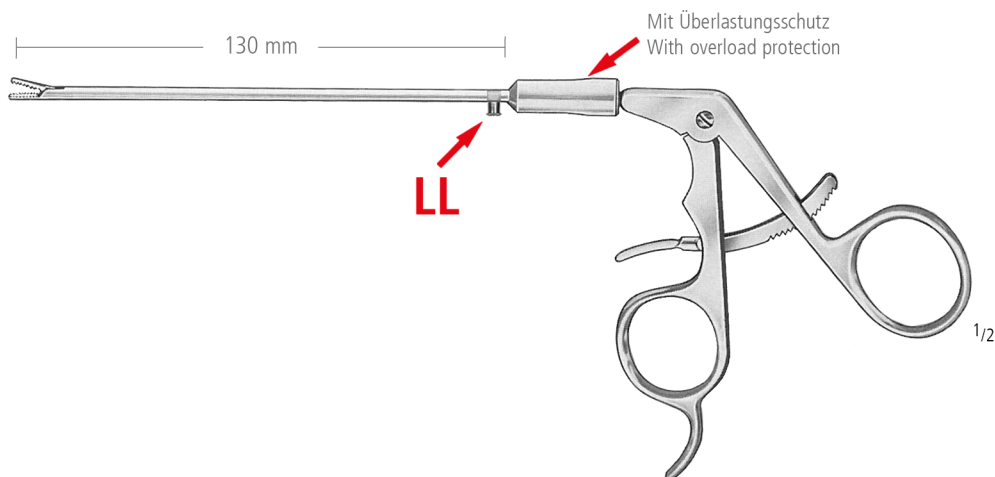

Alligator-Fasszange, mit Sperre, Maulbreite 3,5-2,8 mm
Alligator grasping forceps, with ratchet, jaw width 3.5-2.8 mm

2/1

	gerade straight	7° aufgebogen 7° curved up	15° aufgebogen 15° curved up	30° rechts gebogen 30° curved right	30° links gebogen 30° curved left	45° rechts gebogen 45° curved right	45° links gebogen 45° curved left
Ø 3,4 mm	KA 340/10	KA 340/11	KA 340/13	KA 340/15	KA 340/17	KA 340/19	KA 340/21



Stanzen, Scheren, Faszangen
 Punches, scissors, grasping forceps
 Punzones, tijeras, pinzas de agarre
 Pinzes emporte-pièces, ciseaux, pinces à préhension
 Pinze, forbici, pinze da presa

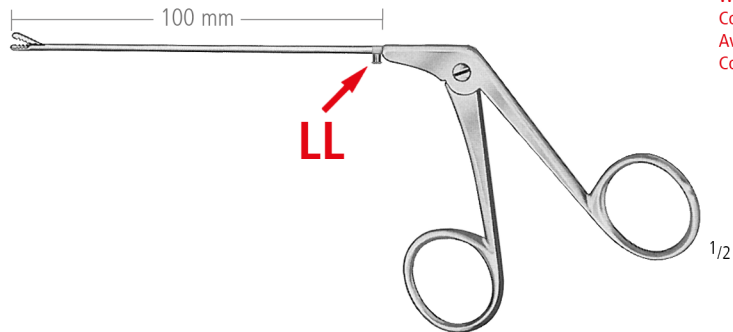

Mit Spülanschluss zur Reinigung
 With flushing connection for cleaning
 Con conexión de irrigación para la limpieza
 Avec connexion d'irrigation pour le nettoyage
 Con connessione di irrigazione

micro



2/1

Mikro Stanze
 micro punch

gerade
 straight

Ø 2,0 mm
 cw* 1,2 mm **KA 345/10**

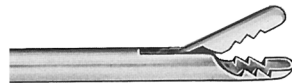

2/1

Mikro Universal-Fasszange
 micro universal grasper

gerade
 straight

Ø 2,0 mm **KA 345/20**

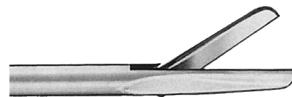

2/1

Mikro Schere
 micro scissors

gerade
 straight

Ø 2,0 mm **KA 345/30**



2/1

Mikro Fasszange mit Löffel
 micro spoon

gerade
 straight

Ø 2,0 mm **KA 345/40**

AA

AB

AC

AD

AE

AF

AK

KA

KA
 arthro

X

KYE



modern

>> valuable
>> pinless

>> affordable
>> two lines

Um eine bestmögliche Reinigung zu erzielen, bietet **nopa** mit der „**advanced**“ Variante innerhalb der Produktlinie „**modern**“ eine optimierte Ausführung. Der Unterschied zur „**basic**“ Variante liegt in der Ausführung des Schafts. Die in dem Schaft integrierten Öffnungen erlauben eine verbesserte Reinigung der Instrumente.

To ensure optimal cleaning, **nopa** offers the “**advanced**” model with its enhanced design as part of the “**modern**” range. This can be distinguished from the “**basic**” version by the design of the shaft. The apertures integrated in the shaft make it easier to clean the instruments.

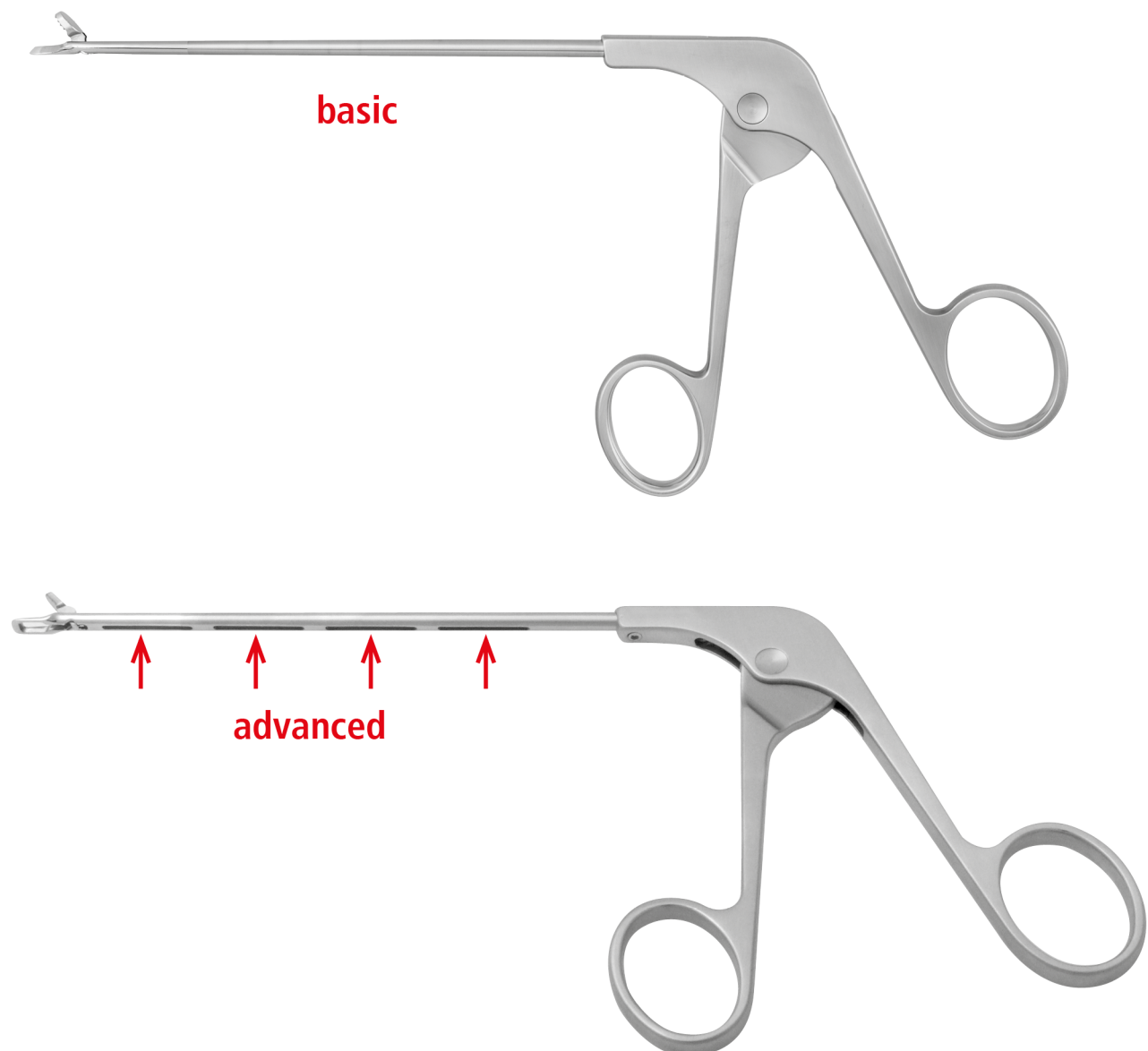

types of working ends

Verschiedene Ausführungen der Arbeitsenden erleichtern den Zugang zu Gelenken:

Different types of working ends enable easy access to joints:



gerade
straight



Maul aufgewinkelt
upbiter

Leichter Zugang zum hinteren Bereich des Meniskus.

Facilitated access to the posterior meniscus.



Schaft 15° aufgebogen
shaft 15° curved up

Folgt der Kontur des Kondylus und hält die geschnittene Oberfläche parallel zum Tibial Plateau.

Follows the contour of the condyle and keeps the cutting surface parallel to the tibial plateau.

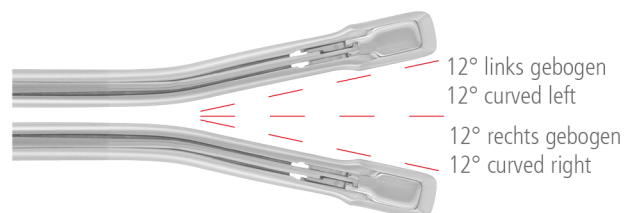

Schaft 12° links/rechts gebogen
shaft 12° curved left/right

Zum Erreichen des vorderen und hinteren Meniskus.

To reach the anterior and posterior meniscus.

modern

dimensions

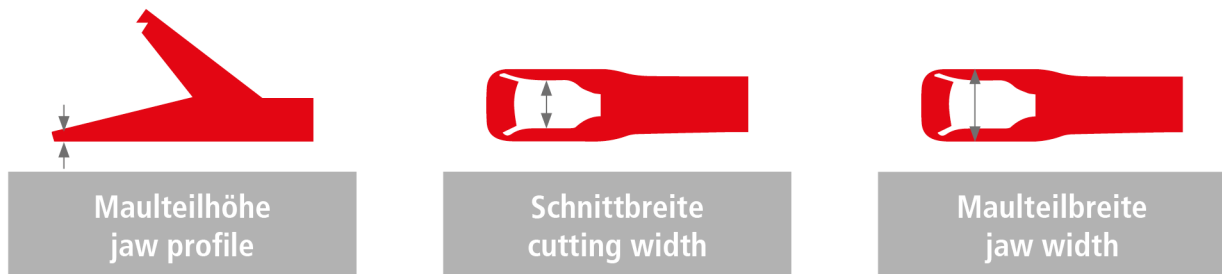

cutting width / jaw width

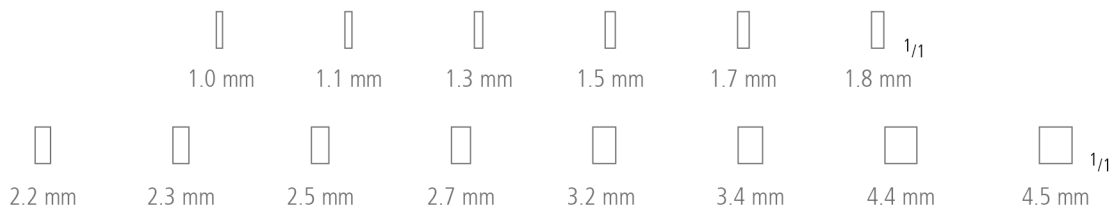

lengths of shafts



KNIE-INSTRUMENTE
KNEE INSTRUMENTS
INSTRUMENTOS DE RODILLA
INSTRUMENTS POUR LE GENOU
STRUMENTI PER GINOCCHIO



nopa[®] instruments



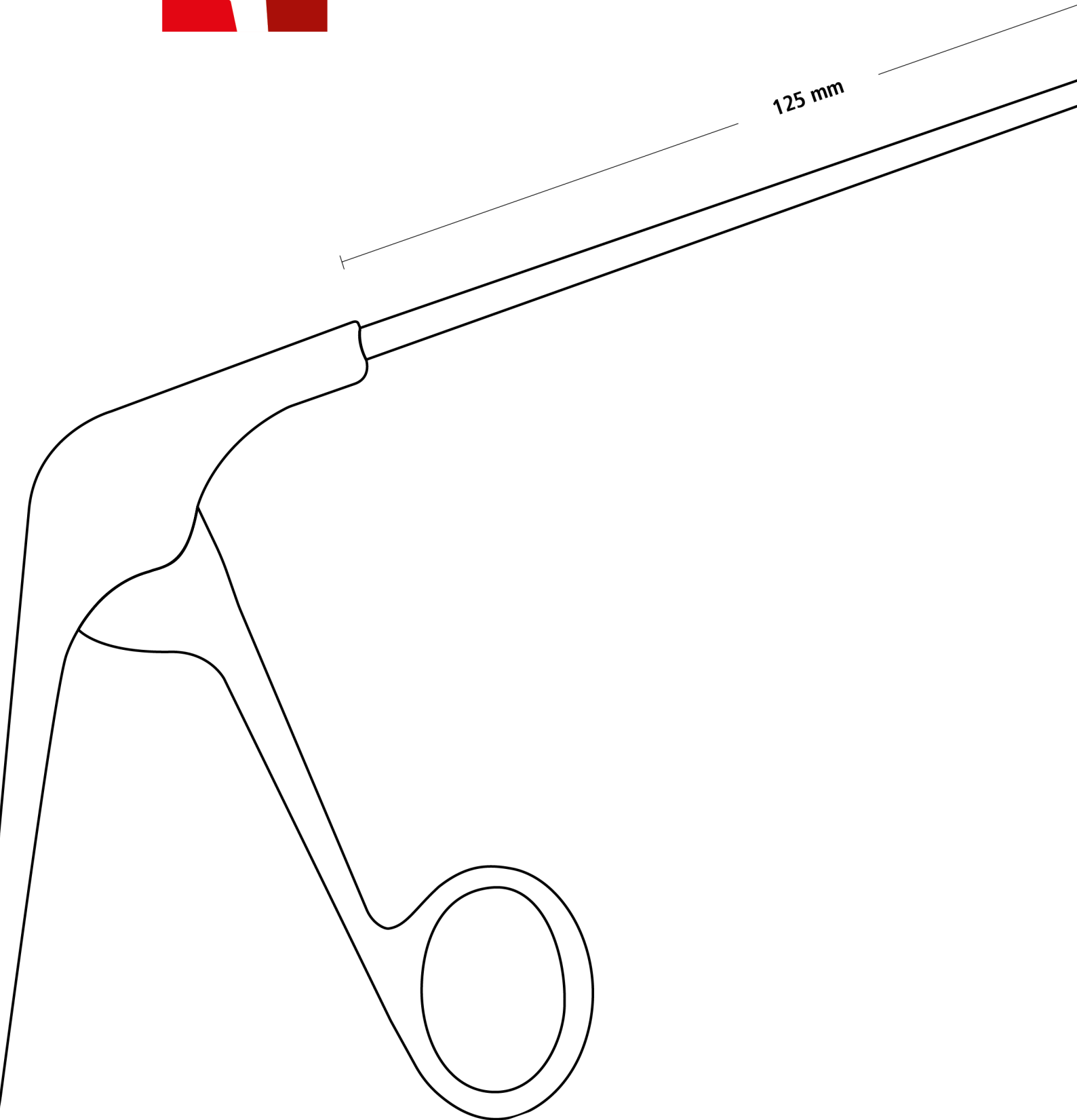

GRIFFE / HANDLES

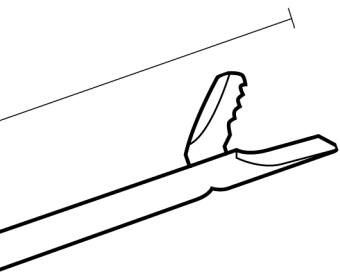

Klassik Griff
classic handle



Ergo Griff
ergo handle



Sperrengriff
slide-lock handle



Rotierbarer Ringgriff
rotatable handle



Rotierbarer Axialgriff
rotatable axial handle

SCHÄFTE / SHAFTS

basic



advanced

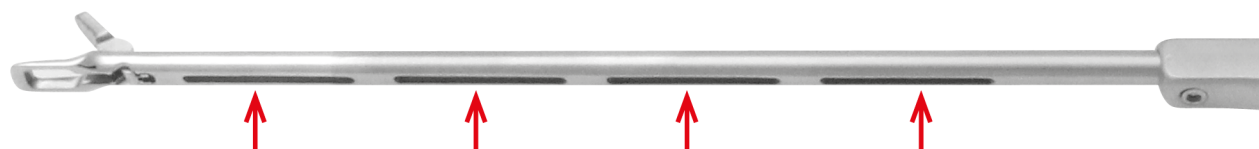

SET**ZS 983/01**

suggested basic set for knee arthroscopy



Art.No.	description	qty.	page
KA 301/06	SCALPEL KNIFE, 115 MM, TRIANGULAR HANDLE	1	47
KA 301/10	BANANA KNIFE, SERRATED, 115 MM, TRIANGULAR HANDLE	1	47
KA 301/13	RING CURETTE, 3.0 MM, 30° ANGLED, 115 MM, TRIANGULAR HANDLE	1	47
KA 301/16	SMILLIE MENISCOTOME, 5.0 MM, 115 MM, TRIANGULAR HANDLE	1	47
KA 301/19	HOOK PROBE, 3.5 MM, GRADUATED, 115MM, TRIANGULAR HANDLE	1	47
KA 352/01*	DUCKLY PUNCH MEDIUM, STRAIGHT, 125 MM, CLASSIC HANDLE	1	68
KA 352/25*	DUCKLY PUNCH MEDIUM, UPBITER, STRAIGHT, 125 MM, CLASSIC HANDLE	1	69
KA 352/31*	DUCKLY PUNCH MEDIUM, UPBITER, CURVED LEFT, 125 MM, CLASSIC HANDLE	1	69
KA 352/37*	DUCKLY PUNCH MEDIUM, UPBITER, CURVED RIGHT, 125 MM, CLASSIC HANDLE	1	69
KA 359/01*	HOOK PUNCH BLUNT, STRAIGHT, 125 MM, CLASSIC HANDLE	1	74
KA 367/33*	GRASPING FORCEPS ALLIGATOR 3.4 MM, STRAIGHT, 125 MM, SLIDE-LOCK HANDLE	1	78
XP 701/43	HD ARTHROSCOPE, Ø 4.0 MM, 30°, 175 MM, AUTOCLAVABLE	1	124
XK 709/12	UNIVERSAL SHEATH FOR OPTIC Ø 4.0 MM, 175 MM, 2 STOPCOCKS	1	124
XK 710/11	TROCAR, SHARP	1	125
XK 710/12	OBTURATOR, BLUNT	1	125

***basic shaft**



SET

ZS 983/11

suggested advanced set for knee arthroscopy



Art.No.	description	qty.	page
KA 301/06	SCALPEL KNIFE, 115 MM, TRIANGULAR HANDLE	1	47
KA 301/10	BANANA KNIFE, SERRATED, 115 MM, TRIANGULAR HANDLE	1	47
KA 301/13	RING CURETTE, 3.0 MM, 30° ANGLED, 115 MM, TRIANGULAR HANDLE	1	47
KA 301/16	SMILLIE MENISCOTOME, 5.0 MM, 115 MM, TRIANGULAR HANDLE	1	47
KA 301/19	HOOK PROBE, 3.5 MM, GRADUATED, 115MM, TRIANGULAR HANDLE	1	47
KA 352/02*	DUCKLY PUNCH MEDIUM, STRAIGHT, 125 MM, CLASSIC HANDLE, ADVANCED	1	68
KA 352/26*	DUCKLY PUNCH MEDIUM, UPBITER, STRAIGHT, 125 MM, CLASSIC HANDLE, ADVANCED	1	69
KA 352/32*	DUCKLY PUNCH MEDIUM, UPBITER, CURVED LEFT, 125 MM, CLASSIC HANDLE, ADVANCED	1	69
KA 352/38*	DUCKLY PUNCH MEDIUM, UPBITER, CURVED RIGHT, 125 MM, CLASSIC HANDLE, ADVANCED	1	69
KA 359/02*	HOOK PUNCH BLUNT, STRAIGHT, 125 MM, CLASSIC HANDLE, ADVANCED	1	74
KA 367/34*	GRASPING FORCEPS ALLIGATOR 3.4 MM, STRAIGHT, 125 MM, SLIDE-LOCK HANDLE, ADVANCED	1	78
XP 701/43	HD ARTHROSCOPE, Ø 4.0 MM, 30°, 175 MM, AUTOCLAVABLE	1	124
XK 709/12	UNIVERSAL SHEATH FOR OPTIC Ø 4.0 MM, 175 MM, 2 STOPCOCKS	1	124
XK 710/11	TROCAR, SHARP	1	125
XK 710/12	OBTURATOR, BLUNT	1	125

***advanced shaft**

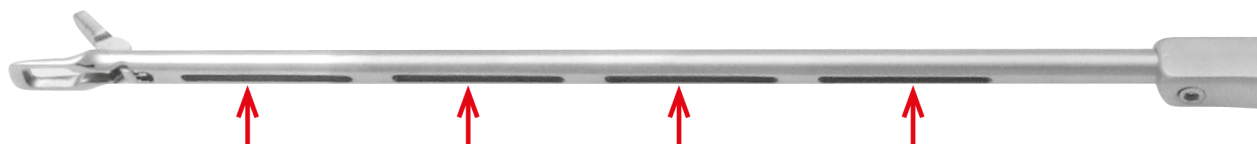



ARTHROSKOPIE ARTHROSCOPY ARTROSCOPIA ARTHROSCOPIE ARTROSCOPIA

Breitmaul-Stanzen
 Wide jaw punches
 Punzones de boca ancha
 Pinces emporte-pièces avec mors larges
 Pinze a bocca larga

Die Breitmaul-Stanze bietet eine maximale Gewebeentnahme durch ihre wellenförmige Zahnung und das breite Maulteil.

The wide jaw punch ensures maximum tissue sampling thanks to its wave-tooth design and wide bite.



Breitmaul-Stanze, klein wide jaw punch, small	Schnittbreite cutting width	Klassik Griff classic handle		Ergo Griff ergo handle	
		basic	advanced	basic	advanced
125 mm Schaft gerade shaft straight	2,5 mm	KA 348/01	KA 348/02	KA 348/03	KA 348/04
Schaft aufgebogen shaft curved up	2,5 mm	KA 348/07	KA 348/08	KA 348/09	KA 348/10



Breitmaul-Stanze, klein, Maul aufgewinkelt wide jaw punch, small, upbiter	Schnittbreite cutting width	Klassik Griff classic handle		Ergo Griff ergo handle	
		basic	advanced	basic	advanced
125 mm Schaft gerade shaft straight	2,5 mm	KA 348/25	KA 348/26	KA 348/27	KA 348/28



Breitmaul-Stanze, medium wide jaw punch, medium	Schnittbreite cutting width	Klassik Griff classic handle		Ergo Griff ergo handle	
		basic	advanced	basic	advanced
125 mm Schaft gerade shaft straight	3,2 mm	KA 349/01	KA 349/02	KA 349/03	KA 349/04
Schaft links gebogen shaft curved left	3,2 mm	KA 349/07	KA 349/08	KA 349/09	KA 349/10
Schaft rechts gebogen shaft curved right	3,2 mm	KA 349/13	KA 349/14	KA 349/15	KA 349/16
Schaft aufgebogen shaft curved up	3,2 mm	KA 349/19	KA 349/20	KA 349/21	KA 349/22

Breitmaul-Stanzen
Wide jaw punches
Punzones de boca ancha
Pincas emporte-pièces avec mors larges
Pinze a bocca larga

KNIE / KNEE

AA

AB

AC

AD

AE

AF

AK

KA

KA
arthro

X

KYE



2/1

**Breitmaul-Stanze, medium,
Maul aufgewinkelt
wide jaw punch, medium,
upbiter**

	Schnittbreite cutting width	Klassik Griff classic handle		Ergo Griff ergo handle	
		basic	advanced	basic	advanced
125 mm					
Schaft gerade shaft straight	3,2 mm	KA 349/25	KA 349/26	KA 349/27	KA 349/28
Schaft links gebogen shaft curved left	3,2 mm	KA 349/31	KA 349/32	KA 349/33	KA 349/34
Schaft rechts gebogen shaft curved right	3,2 mm	KA 349/37	KA 349/38	KA 349/39	KA 349/40
Schaft aufgebogen shaft curved up	3,2 mm	KA 349/43	KA 349/44	KA 349/45	KA 349/46



2/1

**Breitmaul-Stanze, groß
wide jaw punch, large**

	Schnittbreite cutting width	Klassik Griff classic handle		Ergo Griff ergo handle	
		basic	advanced	basic	advanced
125 mm					
Schaft gerade shaft straight	4,5 mm	KA 350/01	KA 350/02	KA 350/03	KA 350/04



2/1

**Breitmaul-Stanze, groß,
Maul aufgewinkelt
wide jaw punch, large, upbiter**

	Schnittbreite cutting width	Klassik Griff classic handle		Ergo Griff ergo handle	
		basic	advanced	basic	advanced
125 mm					
Schaft gerade shaft straight	4,5 mm	KA 350/25	KA 350/26	KA 350/27	KA 350/28



2/1

**Breitmaul-Stanze, Maul aufgew.,
schräger Schnitt
wide jaw punch, upbiter,
diagonal cut**

	Schnittbreite cutting width	Klassik Griff classic handle		Ergo Griff ergo handle	
		basic	advanced	basic	advanced
125 mm					
Schaft links gebogen shaft curved left	3,2 mm	KA 350/49	KA 350/50	KA 350/51	KA 350/52
Schaft rechts gebogen shaft curved right	3,2 mm	KA 350/55	KA 350/56	KA 350/57	KA 350/58



ARTHROSKOPIE ARTHROSCOPY ARTROSCOPIA ARTHROSCOPIE ARTROSCOPIA

Duckly-Stanzen
 Duckly punches
 Duckly punzones
 Duckly pinces emporte-pièces
 Duckly pinze

Die Duckly-Stanze zeichnet sich aus durch eine geringe Maulteilhöhe und ein breites Maul. Dies sorgt für eine optimale Bewegungsfreiheit bis in die hinteren Bereiche des Knies.

The Duckly punch is characterized by having a small jaw height and a wide bite. This offers maximum range of motion right into the rear area of the knee.



2/1

Duckly-Stanze, klein Duckly punch, small	Schnittbreite cutting width	Klassik Griff classic handle		Ergo Griff ergo handle	
		basic	advanced	basic	advanced
125 mm					
Schaft gerade shaft straight	2,5 mm	KA 351/01	KA 351/02	KA 351/03	KA 351/04
Schaft links gebogen shaft curved left	2,5 mm	KA 351/07	KA 351/08	KA 351/09	KA 351/10
Schaft rechts gebogen shaft curved right	2,5 mm	KA 351/13	KA 351/14	KA 351/15	KA 351/16
Schaft aufgebogen shaft curved up	2,5 mm	KA 351/19	KA 351/20	KA 351/21	KA 351/22



2/1

Duckly-Stanze, klein, Maul aufgewinkelt Duckly punch, small, upbiter	Schnittbreite cutting width	Klassik Griff classic handle		Ergo Griff ergo handle	
		basic	advanced	basic	advanced
125 mm					
Schaft gerade shaft straight	2,5 mm	KA 351/25	KA 351/26	KA 351/27	KA 351/28



2/1

Duckly-Stanze, medium Duckly punch, medium	Schnittbreite cutting width	Klassik Griff classic handle		Ergo Griff ergo handle	
		basic	advanced	basic	advanced
125 mm					
Schaft gerade shaft straight	3,2 mm	KA 352/01	KA 352/02	KA 352/03	KA 352/04
Schaft links gebogen shaft curved left	3,2 mm	KA 352/07	KA 352/08	KA 352/09	KA 352/10
Schaft rechts gebogen shaft curved right	3,2 mm	KA 352/13	KA 352/14	KA 352/15	KA 352/16
Schaft aufgebogen shaft curved up	3,2 mm	KA 352/19	KA 352/20	KA 352/21	KA 352/22

Duckly-Stanzen
 Duckly punches
 Duckly punzones
 Duckly pinces emporte-pièces
 Duckly Pinze

KNIE / KNEE

AA
 AB
 AC
 AD
 AE
 AF
 AK
 KA
 X
 KYE



2/1

Duckly-Stanze, medium, Maul aufgewinkelt Duckly punch, medium, upbiter	Schnittbreite cutting width	Klassik Griff classic handle		Ergo Griff ergo handle	
		basic	advanced	basic	advanced
125 mm Schaft gerade shaft straight	3,2 mm	KA 352/25	KA 352/26	KA 352/27	KA 352/28
Schaft links gebogen shaft curved left	3,2 mm	KA 352/31	KA 352/32	KA 352/33	KA 352/34
Schaft rechts gebogen shaft curved right	3,2 mm	KA 352/37	KA 352/38	KA 352/39	KA 352/40
Schaft aufgebogen shaft curved up	3,2 mm	KA 352/43	KA 352/44	KA 352/45	KA 352/46



2/1

Duckly-Stanze, groß Duckly punch, large	Schnittbreite cutting width	Klassik Griff classic handle		Ergo Griff ergo handle	
		basic	advanced	basic	advanced
125 mm Schaft gerade shaft straight	4,5 mm	KA 353/01	KA 353/02	KA 353/03	KA 353/04
Schaft links gebogen shaft curved left	4,5 mm	KA 353/07	KA 353/08	KA 353/09	KA 353/10
Schaft rechts gebogen shaft curved right	4,5 mm	KA 353/13	KA 353/14	KA 353/15	KA 353/16
Schaft aufgebogen shaft curved up	4,5 mm	KA 353/19	KA 353/20	KA 353/21	KA 353/22



2/1

Duckly-Stanze, groß, Maul aufgewinkelt Duckly punch, large, upbiter	Schnittbreite cutting width	Klassik Griff classic handle		Ergo Griff ergo handle	
		basic	advanced	basic	advanced
125 mm Schaft gerade shaft straight	4,5 mm	KA 353/25	KA 353/26	KA 353/27	KA 353/28



2/1

Duckly-Stanze Elevator Duckly punch elevator	Schnittbreite cutting width	Klassik Griff classic handle		Ergo Griff ergo handle	
		basic	advanced	basic	advanced
125 mm Schaft gerade shaft straight	3,2 mm	KA 353/49	KA 353/50	KA 353/51	KA 353/52





ARTHROSKOPIE ARTHROSCOPY ARTROSCOPIA ARTHROSCOPIE ARTROSCOPIA

Stanzen schmal
Punches slim
Punzones estrechos
Pincas emporte-pièces étroites
Pinze fini

Eine schmale Maulteilbreite verbunden mit einem scharfen Schnitt ermöglicht selbst in engen Gelenken große Bewegungsfreiheit und bietet viele Varianten des Schneidens.

The narrow width combined with the ability to make sharp incisions enables maximum range of motion even in tightly confined joint spaces and allows a large variety of cutting operations.



2/1

Stanze, schmal punch, slim	Schnittbreite cutting width	Klassik Griff classic handle		Ergo Griff ergo handle	
		basic	advanced	basic	advanced
125 mm					
Schaft gerade shaft straight	1,8 mm	KA 354/01	KA 354/02	KA 354/03	KA 354/04
Schaft aufgebogen shaft curved up	1,8 mm	KA 354/07	KA 354/08	KA 354/09	KA 354/10



2/1

Stanze, schmal, Maul aufgewinkelt punch, slim, upbiter	Schnittbreite cutting width	Klassik Griff classic handle		Ergo Griff ergo handle	
		basic	advanced	basic	advanced
125 mm					
Schaft gerade shaft straight	1,8 mm	KA 354/25	KA 354/26	KA 354/27	KA 354/28
Schaft links gebogen shaft curved left	1,8 mm	KA 354/31	KA 354/32	KA 354/33	KA 354/34
Schaft rechts gebogen shaft curved right	1,8 mm	KA 354/37	KA 354/38	KA 354/39	KA 354/40



2/1

Stanze, schmal punch, slim	Schnittbreite cutting width	Klassik Griff classic handle		Ergo Griff ergo handle	
		basic	advanced	basic	advanced
125 mm					
Schaft gerade, Maul 45° links gewinkelt shaft straight, jaw 45° angled left	1,8 mm	KA 354/49	KA 354/50	KA 354/51	KA 354/52
Schaft gerade, Maul 45° rechts gewinkelt shaft straight, jaw 45° angled right	1,8 mm	KA 354/55	KA 354/56	KA 354/57	KA 354/58

ARTHROSKOPIE ARTHROSCOPY ARTROSCOPIA ARTHROSCOPIE ARTROSCOPIA

Stanzen oval
Punches oval
Punzones ovales
Pincas emporte-pièces ovales
Pinze ovali

KNIE / KNEE

Durch die ovale Ausführung des Maulteils erhält die Stanze den größten Schnitt.

The oval design of the jaws allows the punch to make the largest incisions.



2/1

Stanze, oval punch, oval	Schnittbreite cutting width	Klassik Griff classic handle		Ergo Griff ergo handle	
		basic	advanced	basic	advanced
125 mm					
Schaft gerade shaft straight	4,4 mm	KA 355/01	KA 355/02	KA 355/03	KA 355/04
Schaft links gebogen shaft curved left	4,4 mm	KA 355/07	KA 355/08	KA 355/09	KA 355/10
Schaft rechts gebogen shaft curved right	4,4 mm	KA 355/13	KA 355/14	KA 355/15	KA 355/16
Schaft aufgebogen shaft curved up	4,4 mm	KA 355/19	KA 355/20	KA 355/21	KA 355/22



2/1

Stanze, oval, Maul aufgewinkelt punch, oval, upbiter	Schnittbreite cutting width	Klassik Griff classic handle		Ergo Griff ergo handle	
		basic	advanced	basic	advanced
125 mm					
Schaft gerade shaft straight	4,4 mm	KA 355/25	KA 355/26	KA 355/27	KA 355/28
Schaft links gebogen shaft curved left	4,4 mm	KA 355/31	KA 355/32	KA 355/33	KA 355/34
Schaft rechts gebogen shaft curved right	4,4 mm	KA 355/37	KA 355/38	KA 355/39	KA 355/40
Schaft aufgebogen shaft curved up	4,4 mm	KA 355/43	KA 355/44	KA 355/45	KA 355/46



2/1

Stanze, halb oval punch, half oval	Schnittbreite cutting width	Klassik Griff classic handle		Ergo Griff ergo handle	
		basic	advanced	basic	advanced
125 mm					
Schaft gerade, Maul rechts shaft straight, jaw right	3,2 mm	KA 355/49	KA 355/50	KA 355/51	KA 355/52
Schaft gerade, Maul links shaft straight, jaw left	3,2 mm	KA 355/55	KA 355/56	KA 355/57	KA 355/58
Schaft rechts gebogen, Maul rechts shaft curved right, jaw right	3,2 mm	KA 355/61	KA 355/62	KA 355/63	KA 355/64
Schaft links gebogen, Maul links shaft curved left, jaw left	3,2 mm	KA 355/67	KA 355/68	KA 355/69	KA 355/70

AA

AB

AC

AD

AE

AF

AK

KA

KA
arthro

X

KYE



ARTHROSKOPIE ARTHROSCOPY ARTROSCOPIA ARTHROSCOPIE ARTROSCOPIA

Korb-Stanzen
Basket punches
Punzones de basket
Pincas emporte-pièces «basket»
Pinze a canestro

Die Korb-Stanzen sind durch ihre unterschiedlichen Größen flexibel einsetzbar.

The basket punches are highly versatile thanks to their different sizes.



2/1

Korb-Stanze basket punch	Schnittbreite cutting width	Maulteilhöhe jaw profile	Klassik Griff classic handle		Ergo Griff ergo handle	
			basic	advanced	basic	advanced
125 mm						
Schaft gerade shaft straight	1,8 mm	1,0 mm	KA 356/01	KA 356/02	KA 356/03	KA 356/04
Schaft aufgebogen shaft curved up	1,8 mm	1,0 mm	KA 356/07	KA 356/08	KA 356/09	KA 356/10
Schaft links gebogen shaft curved left	1,8 mm	1,3 mm	KA 356/13	KA 356/14	KA 356/15	KA 356/16
Schaft rechts gebogen shaft curved right	1,8 mm	1,3 mm	KA 356/19	KA 356/20	KA 356/21	KA 356/22



2/1

Korb-Stanze, Maul aufgewinkelt basket punch, upbiter	Schnittbreite cutting width	Maulteilhöhe jaw profile	Klassik Griff classic handle		Ergo Griff ergo handle	
			basic	advanced	basic	advanced
125 mm						
Schaft gerade shaft straight	1,8 mm	1,3 mm	KA 356/25	KA 356/26	KA 356/27	KA 356/28
Schaft links gebogen shaft curved left	1,8 mm	1,3 mm	KA 356/31	KA 356/32	KA 356/33	KA 356/34
Schaft rechts gebogen shaft curved right	1,8 mm	1,3 mm	KA 356/37	KA 356/38	KA 356/39	KA 356/40



2/1

Korb-Stanze basket punch	Schnittbreite cutting width	Maulteilhöhe jaw profile	Klassik Griff classic handle		Ergo Griff ergo handle	
			basic	advanced	basic	advanced
125 mm						
Schaft aufgebogen shaft curved up	1,8 mm	1,3 mm	KA 356/49	KA 356/50	KA 356/51	KA 356/52
Schaft gerade shaft straight	1,8 mm	1,5 mm	KA 356/55	KA 356/56	KA 356/57	KA 356/58

ARTHROSKOPIE ARTHROSCOPY ARTROSCOPIA ARTHROSCOPIE ARTROSCOPIA

Korb-Stanzen
Basket punches
Punzones de basket
Pincas emporte-pièces «basket»
Pinze a canestro

KNIE / KNEE

AA

AB

AC

AD

AE

AF

AK

KA

KA
arthro

X

KYE



2/1

Korb-Stanze basket punch	Schnittbreite cutting width	Maulteilhöhe jaw profile	Klassik Griff classic handle		Ergo Griff ergo handle	
			basic	advanced	basic	advanced
125 mm Schaft aufgebogen shaft curved up	1,8 mm	1,5 mm	KA 357/01	KA 357/02	KA 357/03	KA 357/04
Schaft gerade shaft straight	1,8 mm	2,7 mm	KA 357/07	KA 357/08	KA 357/09	KA 357/10
Schaft gerade shaft straight	1,8 mm	3,4 mm	KA 357/13	KA 357/14	KA 357/15	KA 357/16



2/1

Korb-Stanze, Maul aufgewinkelt basket punch, upbiter	Schnittbreite cutting width	Maulteilhöhe jaw profile	Klassik Griff classic handle		Ergo Griff ergo handle	
			basic	advanced	basic	advanced
125 mm Schaft gerade shaft straight	1,8 mm	1,5 mm	KA 357/25	KA 357/26	KA 357/27	KA 357/28



2/1

Korb-Stanze, Maul abgewinkelt basket punch, downbiter	Schnittbreite cutting width	Maulteilhöhe jaw profile	Klassik Griff classic handle		Ergo Griff ergo handle	
			basic	advanced	basic	advanced
125 mm Schaft gerade shaft straight	1,8 mm	1,3 mm	KA 357/49	KA 357/50	KA 357/51	KA 357/52



2/1

Korb-Stanze, kurzer Schnitt basket punch, short cut	Schnittbreite cutting width	Maulteilhöhe jaw profile	Klassik Griff classic handle		Ergo Griff ergo handle	
			basic	advanced	basic	advanced
125 mm Schaft gerade shaft straight	1,8 mm		KA 357/73	KA 357/74	KA 357/75	KA 357/76



ARTHROSKOPIE ARTHROSCOPY ARTROSCOPIA ARTHROSCOPIE ARTROSCOPIA

Korb-Stanzen mit Meniskusheber, Haken-Stanzen
 Basket punches meniscal elevator, hook punches
 Punzones de basket con elevador de menisco, punzones de gancho
 Pinces emporte-pièces «basket» avec élévateur de ménisque, pinces à crochets
 Pinze a canestro con sollevatore per menisco, pinze a gancio

Bei der Korbstanze mit Meniskusheber unterstützt die Verlängerung der unteren Instrumentenspitze das Schneiden von lagestabilen Menisken.

Using the basket punch with meniscal elevator, the instrument's lower tip can be extended to help cut the meniscus when it is in a stable position.



Korb-Stanze mit Meniskusheber basket punch meniscal elevator	Schnittbreite cutting width	Klassik Griff classic handle		Ergo Griff ergo handle	
		basic	advanced	basic	advanced
125 mm Schaft gerade shaft straight	1,8 mm	KA 358/01	KA 358/02	KA 358/03	KA 358/04



Korb-Stanze mit Meniskusheber, Maul aufgewinkelt basket punch meniscal elevator, upbiter	Schnittbreite cutting width	Klassik Griff classic handle		Ergo Griff ergo handle	
		basic	advanced	basic	advanced
125 mm Schaft gerade shaft straight	1,8 mm	KA 358/25	KA 358/26	KA 358/27	KA 358/28

Die Haken-Stanze ermöglicht durch ihre stumpfe Spitze ein bequemes Anfrischen des Hinterhorns.
 The hook punch has a blunt tip to enable easy repair of the posterior horn.



Haken-Stanze, stumpf hook punch, blunt	Schnittbreite cutting width	Klassik Griff classic handle		Ergo Griff ergo handle	
		basic	advanced	basic	advanced
125 mm Schaft gerade shaft straight	1,8 mm	KA 359/01	KA 359/02	KA 359/03	KA 359/04
Schaft links gebogen shaft curved left	1,8 mm	KA 359/07	KA 359/08	KA 359/09	KA 359/10
Schaft rechts gebogen shaft curved right	1,8 mm	KA 359/13	KA 359/14	KA 359/15	KA 359/16
Schaft aufgebogen shaft curved up	1,8 mm	KA 359/19	KA 359/20	KA 359/21	KA 359/22

ARTHROSKOPIE ARTHROSCOPY ARTROSCOPIA ARTHROSCOPIE ARTROSCOPIA

Posterior-Stanzen, Rückwärtsschneider
 Posterior punches, backbiter
 Punzones posteriores, backbiter
 Pincas emporte-pièces coupe rétrograde
 Pinze posterior, taglierina inversa

KNIE / KNEE

AA

Das kurze Maul und der leicht verjüngte Schaft ermöglichen eine weite Öffnung der Stanze in engen Bereichen des Gelenks.
 The short jaw design and slightly tapered shaft allow the punch to be opened wide in confined areas within the joint.

AB

AC

AD



2/1

Posterior-Stanze posterior punch	Schnittbreite cutting width	Klassik Griff classic handle		Ergo Griff ergo handle	
		basic	advanced	basic	advanced
125 mm Schaft gerade shaft straight	2,2 mm	KA 360/01	KA 360/02	KA 360/03	KA 360/04
Schaft links gebogen shaft curved left	2,2 mm	KA 360/07	KA 360/08	KA 360/09	KA 360/10
Schaft rechts gebogen shaft curved right	2,2 mm	KA 360/13	KA 360/14	KA 360/15	KA 360/16
Schaft aufgebogen shaft curved up	2,2 mm	KA 360/19	KA 360/20	KA 360/21	KA 360/22

AE

AF

AK



2/1

Posterior-Stanze, Maul aufgewinkelt posterior punch, upbiter	Schnittbreite cutting width	Klassik Griff classic handle		Ergo Griff ergo handle	
		basic	advanced	basic	advanced
125 mm Schaft gerade shaft straight	2,2 mm	KA 360/25	KA 360/26	KA 360/27	KA 360/28
Schaft links gebogen shaft curved left	2,2 mm	KA 360/31	KA 360/32	KA 360/33	KA 360/34
Schaft rechts gebogen shaft curved right	2,2 mm	KA 360/37	KA 360/38	KA 360/39	KA 360/40

KA

KA arthro

X

Diese Stanze schneidet rückwärts und bietet so einen erleichterten Zugang zum meniskalen Vorderhorn.
 This punch allows backward cutting, thus making it easier to access the anterior horn of the meniscus.

KYE



2/1

Rückwärtsschneider backbiter	Schnittbreite cutting width	Klassik Griff classic handle		Ergo Griff ergo handle	
		basic	advanced	basic	advanced
125 mm Schaft gerade, Schnitt links shaft straight, left cut	2,3 mm	KA 361/01	KA 361/02	KA 361/03	KA 361/04
Schaft gerade, Schnitt rechts shaft straight, right cut	2,3 mm	KA 361/07	KA 361/08	KA 361/09	KA 361/10



ARTHROSKOPIE ARTHROSCOPY ARTROSCOPIA ARTHROSCOPIE ARTROSCOPIA

Löffelzangen, Scheren-Stanzen, Haken-Scheren
 Rongeurs, scissors punches, hook scissors
 Pinzas de cuchara, punzones de tijeras, tijeras de gancho
 Rongeurs, ciseaux-emporte-pièces et ciseaux crochets
 Pinze a cucchiaio, pinze taglianti, forbici a gancio

Diese Löffelzange ermöglicht das Schneiden und Entfernen von Gewebe des vorderen Kreuzbandes.

The rongeur allows tissue to be cut and removed from the anterior cruciate ligament.



**Löffelzange
rongeur**

125 mm

Schaft gerade
shaft straight

2/1

**Klassik Griff
classic handle**

**Ergo Griff
ergo handle**

	basic	advanced	basic	advanced
	KA 362/01	KA 362/02	KA 362/03	KA 362/04

Die Scherenstanze zeichnet sich durch einen sauberen und glatten Schnitt bei einer sehr schmalen Schneidefläche aus.

The scissors punch is distinguished by its ability to make clean, smooth incisions in a very narrow cutting area.



**Scheren-Stanze
scissors punch**

125 mm

Schaft gerade
shaft straight

2/1

**Schnittbreite
cutting width**

**Klassik Griff
classic handle**

**Ergo Griff
ergo handle**

	basic	advanced	basic	advanced
1,1 mm	KA 363/01	KA 363/02	KA 363/03	KA 363/04
1,1 mm	KA 363/07	KA 363/08	KA 363/09	KA 363/10
1,1 mm	KA 363/13	KA 363/14	KA 363/15	KA 363/16

Schaft links gebogen
shaft curved left

Schaft rechts gebogen
shaft curved right



**Scheren-Stanze,
Maul aufgewinkelt
scissors punch, upbiter**

125 mm

Schaft gerade
shaft straight

2/1

**Schnittbreite
cutting width**

**Klassik Griff
classic handle**

**Ergo Griff
ergo handle**

	basic	advanced	basic	advanced
1,1 mm	KA 363/25	KA 363/26	KA 363/27	KA 363/28
1,1 mm	KA 363/31	KA 363/32	KA 363/33	KA 363/34
1,1 mm	KA 363/37	KA 363/38	KA 363/39	KA 363/40

Schaft links gebogen
shaft curved left

Schaft rechts gebogen
shaft curved right

Durch die hakenförmige Spitze der Haken-Schere wird ein Abrutschen des Gewebes verhindert und zudem ein sauberer Schnitt ermöglicht.

The hooked tip on these scissors prevents the tissue from slipping, which also facilitates a clean incision.



**Haken-Schere
hook scissors**

125 mm

Schaft gerade
shaft straight

2/1

**Klassik Griff
classic handle**

**Ergo Griff
ergo handle**

	basic	advanced	basic	advanced
	KA 364/01	KA 364/02	KA 364/03	KA 364/04
	KA 364/07	KA 364/08	KA 364/09	KA 364/10
	KA 364/13	KA 364/14	KA 364/15	KA 364/16

Schaft links gebogen
shaft curved left

Schaft rechts gebogen
shaft curved right

ARTHROSKOPIE ARTHROSCOPY ARTROSCOPIA ARTHROSCOPIE ARTROSCOPIA

Dreh-Stanzen, Rotierende Scheren
 Rotary punches, rotary hook scissors
 Punzones rotativos, tijeras de gancho rotativas
 Pincas emporte-pièces rotatives, ciseaux rotatifs
 Pinze girevoli, pinze rotanti

KNIE / KNEE

Das seitlich geöffnete Maul der Dreh-Stanze erleichtert die Bearbeitung der Meniskuskante am schwer zugänglichen Vorderhorn.
 The lateral jaw opening on the rotary punch makes it easier to work on the edge of the meniscus in the posterior horn, which is difficult to access.



2/1

Dreh-Stanze rotary punch	Schnittbreite cutting width	Rotierbarer Ringgriff rotatable handle		Rotierbarer Axialgriff rotatable axial handle	
		basic	with LUER	basic	with LUER
125 mm Schaft gerade, Maul 90° links gewinkelt shaft straight, jaw 90° angled left	2,2 mm	KA 365/01	KA 365/02	KA 365/03	KA 365/04
Schaft gerade, Maul 90° rechts gewinkelt shaft straight, jaw 90° angled right	2,2 mm	KA 365/07	KA 365/08	KA 365/09	KA 365/10
Schaft gerade, Maul 90° links gewinkelt shaft straight, jaw 90° angled left	3,4 mm	KA 365/13	KA 365/14	KA 365/15	KA 365/16
Schaft gerade, Maul 90° rechts gewinkelt shaft straight, jaw 90° angled right	3,4 mm	KA 365/19	KA 365/20	KA 365/21	KA 365/22

Ein Seitwärtsschneiden dieser Haken-Scheren wird durch eine besondere Mechanik ermöglicht. Dies bietet einen hervorragenden Zugang zu allen Bereichen des Meniskus.

A special mechanism allows these hook scissors to make lateral incisions. This enables excellent access to all areas of the meniscus.



2/1

Rotierende Haken-Schere rotary hook scissors	Rotierbarer Ringgriff rotatable handle		Rotierbarer Axialgriff rotatable axial handle	
	basic	advanced	basic	advanced
125 mm Schaft gerade, Maul 20° links gewinkelt shaft straight, jaw 20° angled left	KA 366/01	KA 366/02	KA 366/03	KA 366/04
Schaft gerade, Maul 20° rechts gewinkelt shaft straight, jaw 20° angled right	KA 366/07	KA 366/08	KA 366/09	KA 366/10



2/1

Rotierende Haken-Schere rotary hook scissors	Rotierbarer Ringgriff rotatable handle		Rotierbarer Axialgriff rotatable axial handle	
	basic	advanced	basic	advanced
125 mm Schaft gerade, Maul 60° links gewinkelt shaft straight, jaw 60° angled left	KA 366/25	KA 366/26	KA 366/27	KA 366/28
Schaft gerade, Maul 60° rechts gewinkelt shaft straight, jaw 60° angled right	KA 366/31	KA 366/32	KA 366/33	KA 366/34



2/1

Rotierende Schere, gezahnt rotary scissors, serrated	Rotierbarer Ringgriff rotatable handle		Rotierbarer Axialgriff rotatable axial handle	
	basic	advanced	basic	advanced
125 mm Schaft gerade, Maul 20° links gewinkelt shaft straight, jaw 20° angled left	KA 366/49	KA 366/50	KA 366/51	KA 366/52
Schaft gerade, Maul 20° rechts gewinkelt shaft straight, jaw 20° angled right	KA 366/55	KA 366/56	KA 366/57	KA 366/58

AA

AB

AC

AD

AE

AF

AK

KA

KA
arthro

X

KYE



ARTHROSKOPIE ARTHROSCOPY ARTROSCOPIA ARTHROSCOPIE ARTROSCOPIA

Fasszangen
Grasping forceps
Pinzas de agarre
Pincés à préhension
Pinze da presa

Die Fasszange in ihren verschiedenen Ausführungen bietet alle Möglichkeiten zum Fassen von Gewebe in jedem Gelenkbereich.
The grasping forceps come in various designs to provide every option for grasping tissue in any joint area.



Alligator Fasszange Alligator grasping forceps	Maulbreite jaw width	Sperrengriff slide-lock handle	
		basic	advanced
125 mm Schaft gerade shaft straight	2,7 mm	KA 367/01	KA 367/02
Schaft aufgebogen shaft curved up	2,7 mm	KA 367/05	KA 367/06



Alligator Fasszange, Maul aufgewinkelt Alligator grasping forceps, upbiter	Maulbreite jaw width	Sperrengriff slide-lock handle	
		basic	advanced
125 mm Schaft gerade shaft straight	2,7 mm	KA 367/17	KA 367/18
Schaft aufgebogen shaft curved up	2,7 mm	KA 367/21	KA 367/22



Alligator Fasszange Alligator grasping forceps	Maulbreite jaw width	Sperrengriff slide-lock handle	
		basic	advanced
125 mm Schaft gerade shaft straight	3,4 mm	KA 367/33	KA 367/34
Schaft aufgebogen shaft curved up	3,4 mm	KA 367/37	KA 367/38



Fasszange mit Löffel, gezahnt grasping forceps cupped, serrated	Maulbreite jaw width	Sperrengriff slide-lock handle	
		basic	advanced
125 mm Schaft gerade shaft straight	2,7 mm	KA 367/49	KA 367/50
Schaft gerade shaft straight	3,4 mm	KA 367/53	KA 367/54

Fasszangen
Grasping forceps
Pinzas de agarre
Pincas à préhension
Pinze da presa

KNIE / KNEE



Fasszange 1x2 Zähne
grasping forceps 1x2 teeth

125 mm
Schaft gerade
shaft straight

Sperregriff
slide-lock handle

basic advanced

KA 367/65 KA 367/66



Gewebefasszange
tissue grasping forceps

125 mm
Schaft gerade, ohne Führungskanal
shaft straight, without channel

Sperregriff
slide-lock handle

basic advanced

KA 367/81 KA 367/82

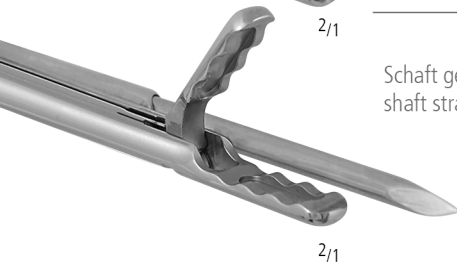

Schaft gerade, mit Führungskanal
shaft straight, with channel

KA 367/85 KA 367/86

AA

AB

AC

AD

AE

AF

AK

KA

KA
arthro

X

KYE



KLEINGELENK-INSTRUMENTE
SMALL JOINT INSTRUMENTS
INSTRUMENTOS DE ARTICULACIÓN PEQUEÑA
INSTRUMENTS P. LES PETITES ARTICULATIONS
STRUMENTI PER LE PICCOLE ARTICOLAZIONI



nopa[®] instruments



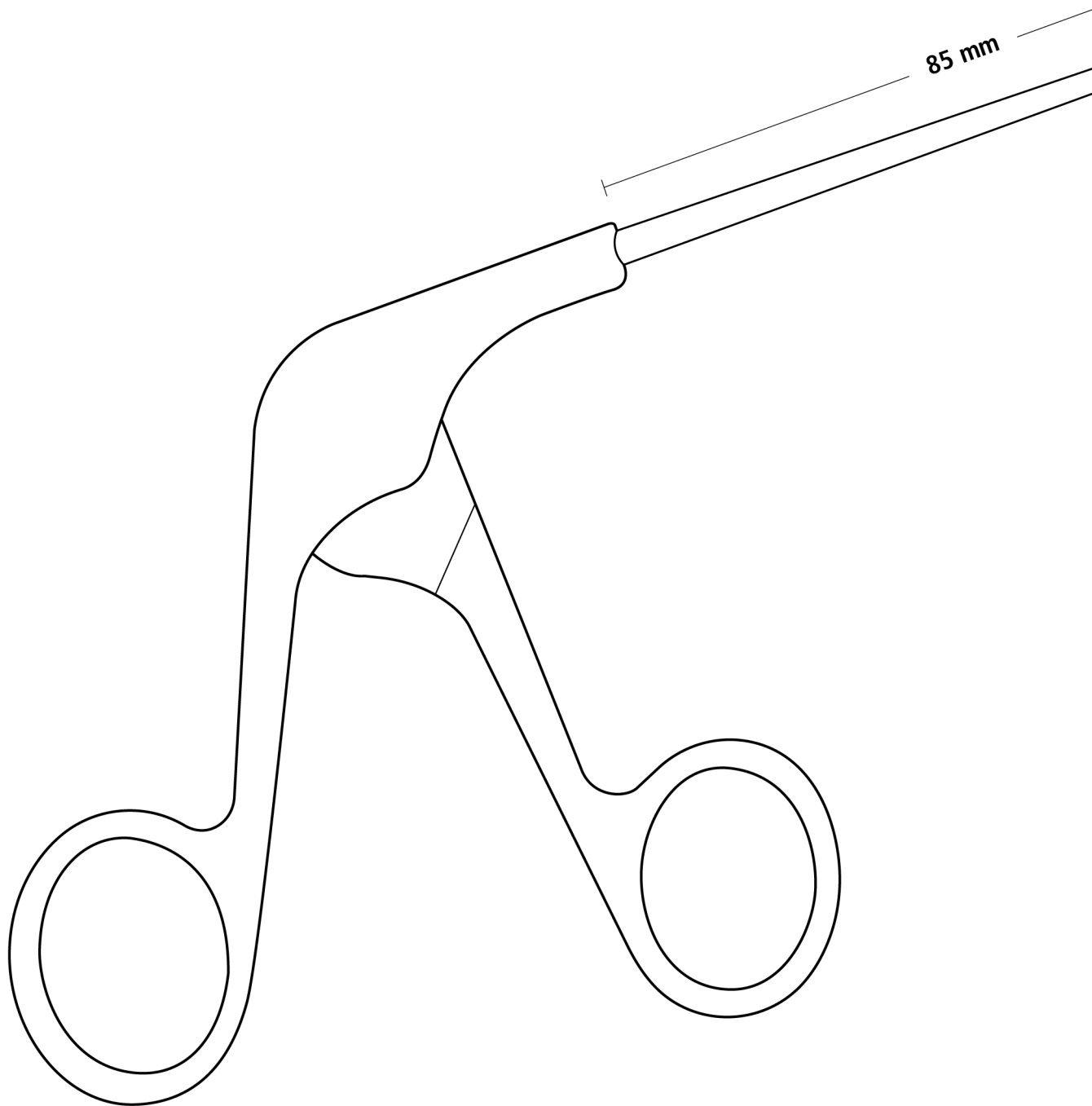

GRIFFE / HANDLES

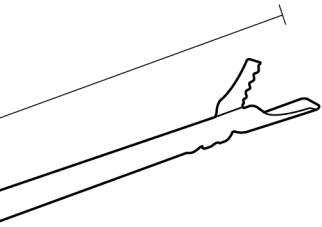

Klassik Griff
classic handle



Sperregriff
slide-lock handle

SCHÄFTE / SHAFTS

basic



advanced

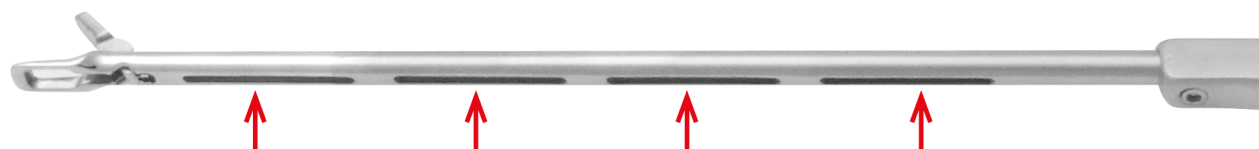

SET**ZS 983/02**

suggested basic set for small joint arthroscopy



Art.No.	description	qty.	page
KA 301/18	HOOK PROBE, 2.5 MM, GRADUATED, 115 MM, TRIANGULAR HANDLE	1	47
KA 370/01*	PUNCH OVAL, STRAIGHT, 85 MM, CLASSIC HANDLE	1	86
KA 370/05*	PUNCH OVAL, CURVED LEFT, 85 MM, CLASSIC HANDLE	1	86
KA 370/09*	PUNCH OVAL, CURVED RIGHT, 85 MM, CLASSIC HANDLE	1	86
KA 370/17*	WIDE JAW PUNCH, STRAIGHT, 85 MM, CLASSIC HANDLE	1	86
KA 373/01*	GRASPING FORCEPS ALLIGATOR, STRAIGHT, 85 MM, SLIDE-LOCK HANDLE	1	87
XP 704/33	HD ARTHROSCOPE Ø 2.7 MM, 30°, 110 MM, AUTOCLAVABLE	1	122
XK 709/32	UNIVERSAL SHEATH FOR OPTIC Ø 2.7 MM, 110 MM, 2 STOPCOCKS	1	122
XK 710/31	TROCAR, SHARP	1	123
XK 710/32	OBTURATOR, BLUNT	1	123

***basic shaft**



SET**ZS 983/12**

suggested advanced set for small joint arthroscopy



Art.No.	description	qty.	page
KA 301/18	HOOK PROBE, 2.5 MM, GRADUATED, 115 MM, TRIANGULAR HANDLE	1	47
KA 370/02*	PUNCH OVAL, STRAIGHT, 85 MM, CLASSIC HANDLE, ADVANCED	1	86
KA 370/06*	PUNCH OVAL, CURVED LEFT, 85 MM, CLASSIC HANDLE, ADVANCED	1	86
KA 370/10*	PUNCH OVAL, CURVED RIGHT, 85 MM, CLASSIC HANDLE, ADVANCED	1	86
KA 370/18*	WIDE JAW PUNCH, STRAIGHT, 85 MM, CLASSIC HANDLE, ADVANCED	1	86
KA 373/02*	GRASPING FORCEPS ALLIGATOR, STRAIGHT, 85 MM, SLIDE-LOCK HANDLE, ADVANCED	1	87
XP 704/33	HD ARTHROSCOPE Ø 2.7 MM, 30°, 110 MM, AUTOCLAVABLE	1	122
XK 709/32	UNIVERSAL SHEATH FOR OPTIC Ø 2.7 MM, 110 MM, 2 STOPCOCKS	1	122
XK 710/31	TROCAR, SHARP	1	123
XK 710/32	OBTURATOR, BLUNT	1	123

***advanced shaft**



Stanzen
Punches
Punzones
Pincas emporte-pièces
Pinze

Diese Auswahl an Instrumenten wurde speziell für **kleine Gelenke** zusammengestellt. Kürzere Schäfte sowie kleinere Maulteile bieten einen idealen Zugang für **Ellenbogen, Handgelenk und Sprunggelenk**.

This selection of instruments has been put together specifically for **small joints**. Shorter shafts and smaller jaw sections allow ideal access for **elbow, wrist and ankle joints**.



2/1

Stanze, oval punch, oval	Schnittbreite cutting width	Klassik Griff classic handle	
		basic	advanced
85 mm Schaft gerade shaft straight	2,3 mm	KA 370/01	KA 370/02
Schaft links gebogen shaft curved left	2,3 mm	KA 370/05	KA 370/06
Schaft rechts gebogen shaft curved right	2,3 mm	KA 370/09	KA 370/10



2/1

Breitmaul-Stanze wide jaw punch	Schnittbreite cutting width	Klassik Griff classic handle	
		basic	advanced
85 mm Schaft gerade shaft straight	2,3 mm	KA 370/17	KA 370/18



2/1

Breitmaul-Stanze, Maul aufgewinkelt wide jaw punch, upbiter	Schnittbreite cutting width	Klassik Griff classic handle	
		basic	advanced
85 mm Schaft gerade shaft straight	2,3 mm	KA 370/33	KA 370/34



2/1

Korb-Stanze, stumpfe Spitze basket punch, blunt tip	Schnittbreite cutting width	Klassik Griff classic handle	
		basic	advanced
85 mm Schaft gerade shaft straight	1,7 mm	KA 370/49	KA 370/50

Scheren, Löffelzangen, Fasszangen
 Scissors, rongeurs, grasping forceps
 Tijeras, pinzas de cuchara, pinzas de agarre
 Ciseaux, rongeurs, pinces à préhension
 Forbici, pinze a cucchiaio, pinze da presa

KLEINGELENK / SMALL JOINT

AA
AB
AC
AD
AE
AF
AK
KA
X
KYE



2/1

Haken-Schere hook scissors	Klassik Griff classic handle	
85 mm	basic	advanced
Schaft gerade shaft straight	KA 372/01	KA 372/02



2/1

Löffelzange rongeur	Klassik Griff classic handle	
85 mm	basic	advanced
Schaft gerade shaft straight	KA 372/17	KA 372/18



2/1

Alligator Fasszange Alligator grasping forceps	Sperrengriff slide-lock handle	
85 mm	basic	advanced
Schaft gerade shaft straight	KA 373/01	KA 373/02



2/1

Fasszange, 1x2 Zähne grasping forceps, 1x2 teeth	Sperrengriff slide-lock handle	
85 mm	basic	advanced
Schaft gerade shaft straight	KA 373/09	KA 373/10





SCHULTER-INSTRUMENTE
SHOULDER INSTRUMENTS
INSTRUMENTOS DE HOMBRO
INSTRUMENTS POUR L'ÉPAULE
STRUMENTI PER LA SPALLA



nopa[®] instruments



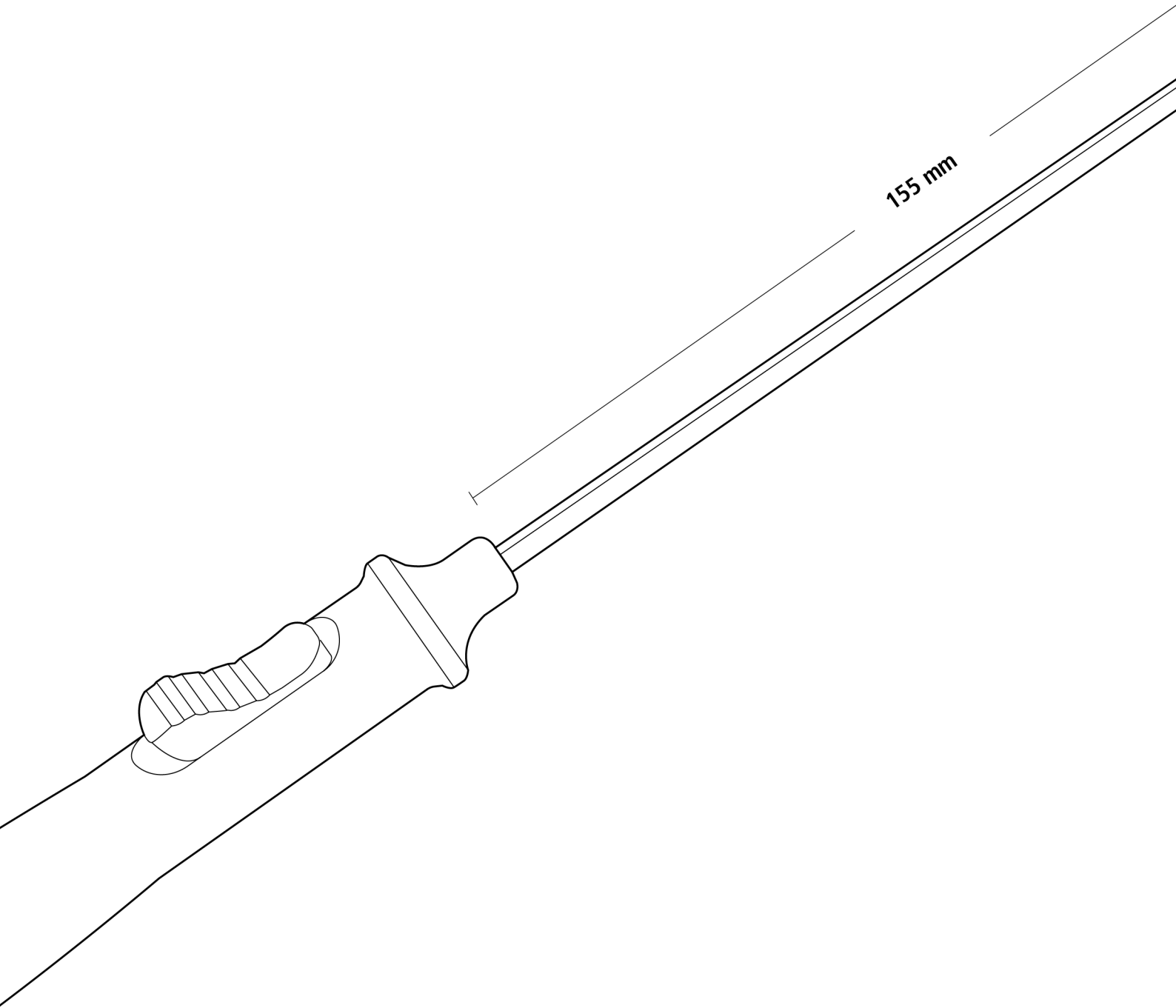

GRIFFE / HANDLES

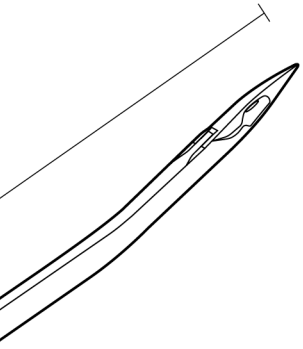

Klassik Griff
classic handle



Sperrengriff
slide-lock handle



Zigarrengriff
cigar handle

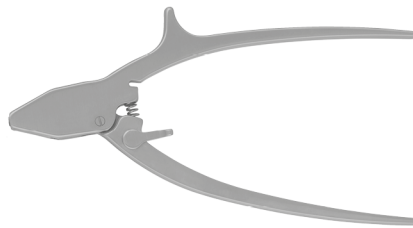

Axialgriff ohne Sperre
axial handle w/o ratchet

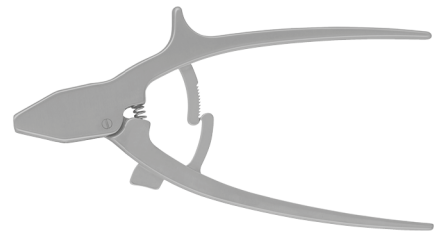

Axialgriff mit Sperre
axial handle with ratchet

SCHÄFTE / SHAFTS

basic



advanced

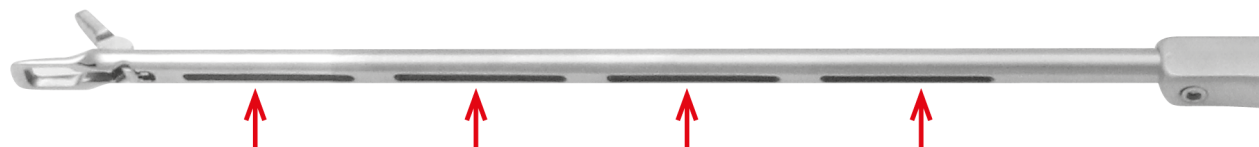

SET**ZS 983/03**

suggested basic set for shoulder arthroscopy



Art.No.	description	qty.	page
KA 301/13	RING CURETTE, 3.0 MM, 30° ANGLED, 115 MM, TRIANGULAR HANDLE	1	47
KA 301/18	HOOK PROBE, 2.5 MM, GRADUATED, 115 MM, TRIANGULAR HANDLE	1	47
KA 301/30	CARTILAGE RASP, FINE, 115 MM, TRIANGULAR HANDLE	1	47
KA 301/31	CARTILAGE RASP, HEAVY, 115 MM, TRIANGULAR HANDLE	1	47
KA 307/02	KNOT PUSHER CLOSED Ø 4 MM, STRAIGHT, 155 MM	1	50
KA 383/01*	BIRD BEAK SUTURE HOOK FORCEPS, STRAIGHT, 155 MM, CLASSIC HANDLE	1	104
KA 383/81*	BIRD BEAK SUTURE HOOK FORCEPS, JAW 20° CURVED UP, STRAIGHT, 155 MM, CLASSIC HANDLE	1	104
KA 386/01*	SUTURE GRASPER SERRATED, STRAIGHT, 155 MM, CLASSIC HANDLE	1	106
KA 386/81*	SUTURE GRASPER ATRAUMATIC, STRAIGHT, 155 MM, CLASSIC HANDLE	1	106
KA 388/13*	GRASPING FORCEPS CUPPED 3.4 MM, SERRATED, STRAIGHT, 155 MM, SLIDE-LOCK HANDLE	1	107
KA 389/01*	SUTURE CUTTER, STRAIGHT, 155 MM, CLASSIC HANDLE	1	107
XP 701/43	HD ARTHROSCOPE Ø 4.0 MM, 30°, 175 MM, AUTOCLAVABLE	1	124
XK 709/12	UNIVERSAL SHEATH FOR OPTIC Ø 4.0 MM, 175 MM, 2 STOPCOCKS	1	124
XK 710/11	TROCAR, SHARP	1	125
XK 710/12	OBTURATOR, BLUNT	1	125

***basic shaft**



SET**ZS 983/13**

suggested advanced set for shoulder arthroscopy



Art.No.	description	qty.	page
KA 301/13	RING CURETTE, 3.0 MM, 30° ANGLED, 115 MM, TRIANGULAR HANDLE	1	47
KA 301/18	HOOK PROBE, 2.5 MM, GRADUATED, 115 MM, TRIANGULAR HANDLE	1	47
KA 301/30	CARTILAGE RASP, FINE, 115 MM, TRIANGULAR HANDLE	1	47
KA 301/31	CARTILAGE RASP, HEAVY, 115 MM, TRIANGULAR HANDLE	1	47
KA 307/02	KNOT PUSHER CLOSED Ø 4 MM, STRAIGHT, 155 MM	1	50
KA 383/02*	BIRD BEAK SUTURE HOOK FORCEPS, STRAIGHT, 155 MM, CLASSIC HANDLE, ADVANCED	1	104
KA 383/82*	BIRD BEAK SUTURE HOOK FCP., JAW 20° CURVED UP, STRAIGHT, 155 MM, CLASSIC HANDLE, ADV.	1	104
KA 386/02*	SUTURE GRASPER SERRATED, STRAIGHT, 155 MM, CLASSIC HANDLE, ADVANCED	1	106
KA 386/82*	SUTURE GRASPER ATRAUMATIC, STRAIGHT, 155 MM, CLASSIC HANDLE, ADVANCED	1	106
KA 388/14*	GRASPING FORCEPS CUPPED 3.4 MM, SERRATED, STRAIGHT, 155 MM, SLIDE-LOCK HANDLE, ADV.	1	107
KA 389/02*	SUTURE CUTTER, STRAIGHT, 155 MM, CLASSIC HANDLE, ADVANCED	1	107
XP 701/43	HD ARTHROSCOPE Ø 4.0 MM, 30°, 175 MM, AUTOCLAVABLE	1	124
XK 709/12	UNIVERSAL SHEATH FOR OPTIC Ø 4.0 MM, 175 MM, 2 STOPCOCKS	1	124
XK 710/11	TROCAR, SHARP	1	125
XK 710/12	OBTURATOR, BLUNT	1	125

***advanced shaft**

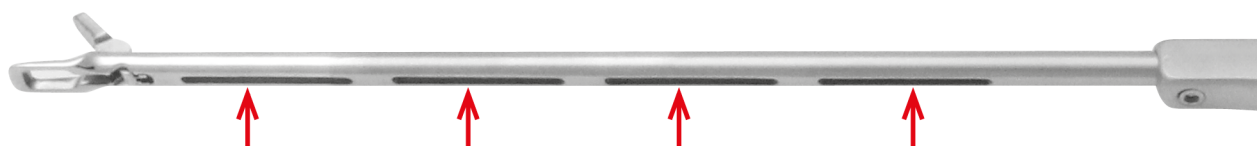



KOELBEL
KA 377/01
18,0 cm/7"

Haut- und Muskelspreizer, gerade, 1x1 Zähne
skin and tissue spreader, straight, 1x1 teeth



KOELBEL
KA 377/02
18,0 cm/7"

Haut- und Muskelspreizer, gewinkelt, 1x1 Zähne
skin and tissue spreader, angled, 1x1 teeth



KOELBEL
KA 377/03
18,0 cm/7"

Haut- und Muskelspreizer, gewinkelt, 2x2 Zähne
skin and tissue spreader, angled, 2x2 teeth



KOELBEL
KA 377/04
16,5 cm/6 1/2"

Haut- und Muskelspreizer, 90° gebogen, 1x1 Zähne
skin and tissue spreader, 90° curved, 1x1 teeth

SCHULTER / SHOULDER

AA

AB

AC

AD

AE

AF

AK

KA

KA
arthro

X

KYE

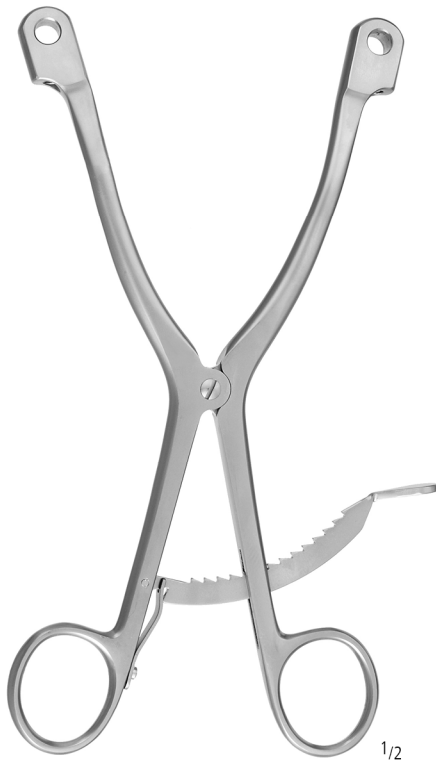

KOELBEL
KA 377/31
20,0 cm/8"

Selbsthaltender Wundspreizer allein
selfretaining retractor only



KA 377/99
11,5 cm/4½"

Wechselpinzette
blade changing forceps



Auswechselbare Valven für KOELBEL Wundspreizer
interchangeable blades for KOELBEL retractor

kurze Valven
short blades

18x36 mm	KA 377/41
20x36 mm	KA 377/42
36x36 mm	KA 377/43



Auswechselbare Valven für KOELBEL Wundspreizer
interchangeable blades for KOELBEL retractor

lange Valven
long blades

18x53 mm	KA 377/51
20x53 mm	KA 377/52
36x53 mm	KA 377/53



Auswechselbare Valven für KOELBEL Wundspreizer
interchangeable blades for KOELBEL retractor

extra lange Valven
extra long blades

18x68 mm	KA 377/61
20x68 mm	KA 377/62
36x68 mm	KA 377/63



FUKUDA
18,0 cm/7"

**Schulterhaken
shoulder retractor**

klein, Breite 32 mm **KA 378/01**
small, width 32 mm

groß, Breite 38 mm **KA 378/02**
large, width 38 mm



FUKUDA
16,5 cm/6 1/2"

**Schulterhaken
shoulder retractor**

klein, Breite 32 mm **KA 378/11**
small, width 32 mm

groß, Breite 40 mm **KA 378/12**
large, width 40 mm



FUKUDA
KA 378/21
21,5 cm/8 1/2"

Schulterhaken mit Riefen, Breite 35 mm
shoulder retractor with grooves, width 35 mm

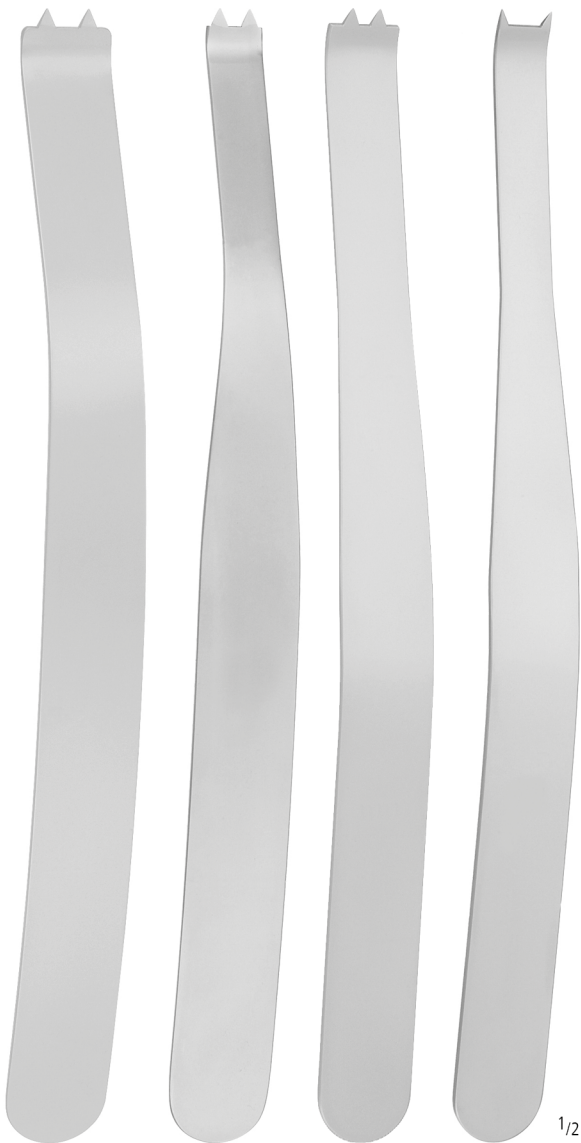

KOELBEL
30,0 cm/12"



25,0 cm/10"

**Schulterhebel
shoulder elevator**

Breite 23 mm, stark gebogen
width 23 mm, strongly curved **KA 379/01**

Breite 15 mm, stark gebogen
width 15 mm, strongly curved **KA 379/02**

Breite 20 mm, gebogen
width 20 mm, curved **KA 379/03**

Breite 15 mm, gebogen
width 15 mm, curved **KA 379/04**

**Kapselretractor, 25 cm
capsule retractor, 25 cm**

1-zinkig
1 prong **KA 379/11**

2-zinkig
2 prongs **KA 379/12**

3-zinkig
3 prongs **KA 379/13**



1/2

DARRACH
26,0 cm/10 1/4"

Schulterheber
shoulder elevator

Breite 9 mm
width 9 mm **KA 379/21**

Breite 12 mm
width 12 mm **KA 379/22**

Breite 16 mm
width 16 mm **KA 379/23**

Breite 25 mm, 36 cm
width 25 mm, 36 cm **KA 379/24**



1/2

KA 379/31
28,5 cm/11 1/4"

Skid-Hebel (Knochenheber und Gleitkürette)
skid lever (bone lever and skid curette)

SCHULTER / SHOULDER



BRISTOW-BANKART
KA 379/51
20,0 cm/8"

Retraktor für Weichgewebe, Breite 21 mm
soft tissue retractor, width 21 mm



BRISTOW-BANKART
KA 379/53
18,0 cm/7"

Humerus-Retraktor, Breite 25 mm
humeral retractor, width 25 mm



KA 379/55
28,0 cm/11"

Anterior Glenoid-Retraktor, Breite 25 mm
anterior glenoid retractor, width 25 mm



KA 379/57
25,0 cm/10"

Posterior Glenoid-Retraktor, Breite 30 mm
posterior glenoid retractor, width 30 mm



GOLDSTEIN
KA 379/59
21,5 cm/8½"

Glenoid-Retraktor, Breite 18 mm
glenoid retractor, width 18 mm

AA

AB

AC

AD

AE

AF

AK

KA

KA
arthro

X

KYE



BHATTMAN
KA 379/61
25,0 cm/10"

Humeruskopf-Retraktor
humeral head retractor



KA 379/63
19,0 cm/7½"

Humeruskopf-Retraktor
humeral head retractor

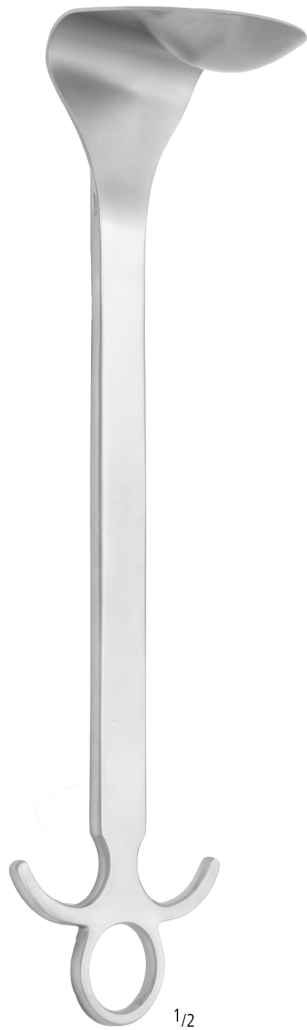

BROWNE
KA 379/67
27,0 cm/10³/₄"

Deltoideus-Haken
deltoid retractor



KA 379/69
20,0 cm/8"

Deltoideus-Haken, Breite 30 mm
deltoid retractor, width 30 mm



CHANDLER
23,0 cm/9"

Haken
retractor

Breite 16 mm
width 16 mm **KA 379/71**

Breite 19 mm
width 19 mm **KA 379/72**

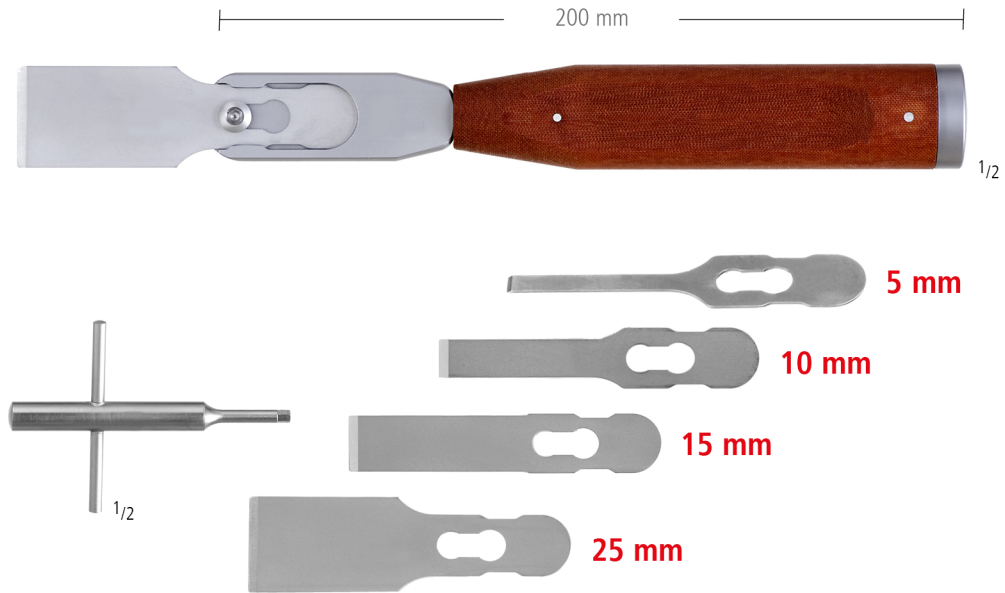

Meißel-Set mit auswechselbaren Klingen komplett, bestehend aus:
chisel set with interchangeable blades complete, consisting of:

KA 380/00

Handgriff, 200 mm
 handle, 200 mm

KA 380/01

Schraubendreher, 75 mm
 wrench, 75 mm

KA 380/03

Meißelklinge, 5 mm
 chisel blade, 5 mm

KA 380/05

Meißelklinge, 10 mm
 chisel blade, 10 mm

KA 380/10

Meißelklinge, 15 mm
 chisel blade, 15 mm

KA 380/15

Meißelklinge, 25 mm
 chisel blade, 25 mm

KA 380/25

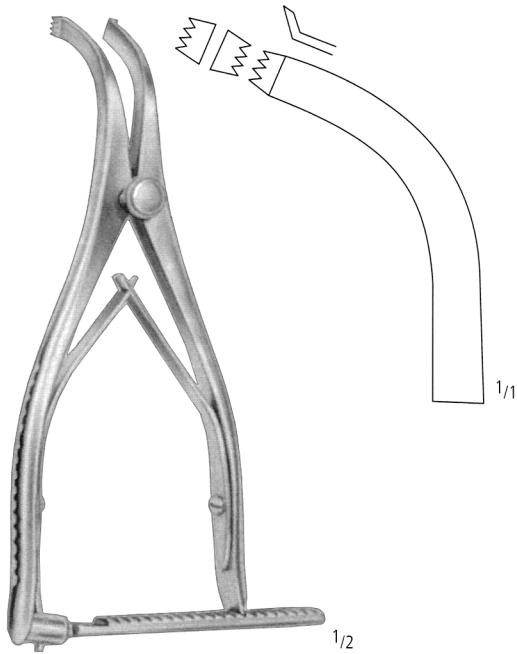

INGE
KS 593/17
16,5 cm/6½"

Laminaspreizer
lamina spreader

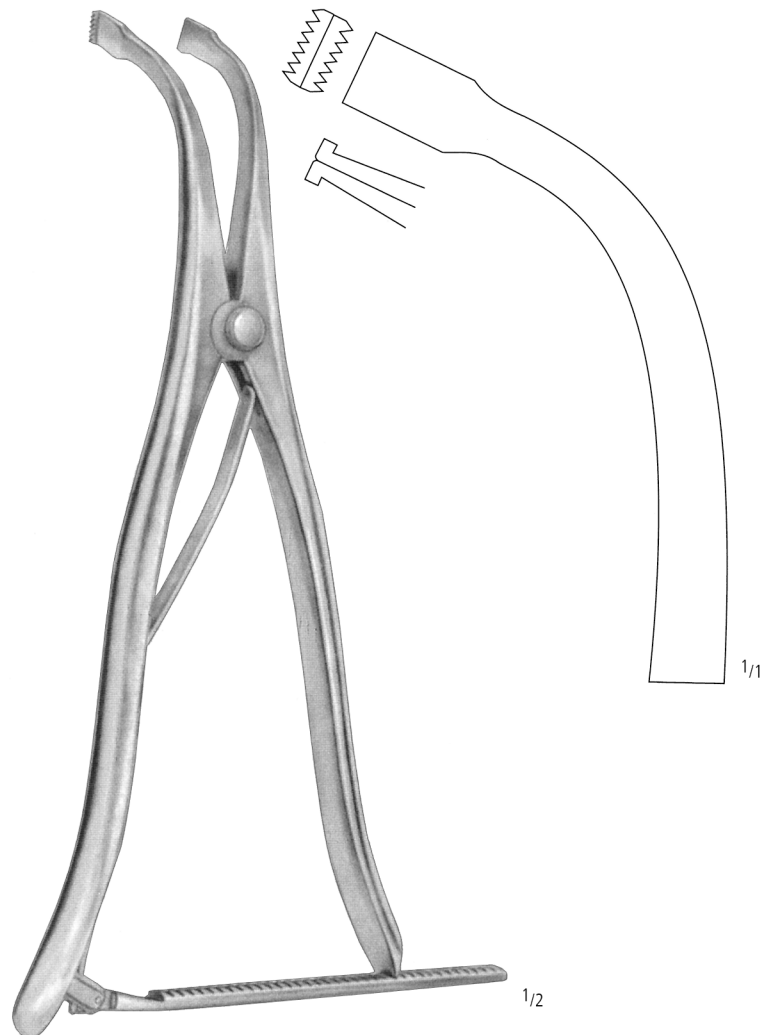

INGE
KS 594/27
27,0 cm/10¾"

Laminaspreizer
lamina spreader



ARTHROSKOPIE ARTHROSCOPY ARTROSCOPIA ARTHROSCOPIE ARTROSCOPIA

Fadenhalter
Suture hook forceps
Portahilos
Pincas à sutures „crochet“
Portafiletto

Diese Instrumente wurden speziell für den Bereich der **Schulter** gefertigt. Das flache Profil und die scharfe Spitze erleichtern das Durchdringen des Gewebes, das Fassen von Fäden und das Zunähen.

These instruments have been produced specifically for the **shoulder** area. The shallow profile and sharp tip makes it easier to pierce tissue, grasp threads and suture everything successfully.



2/1

Bird Beak, Fadenhalter Bird Beak, suture hook forceps	Klassik Griff classic handle		Axialgriff ohne Sperre axial handle w/o ratchet		Zigarrengriff cigar handle	
	basic	advanced	basic	advanced	basic	advanced
155 mm Schaft gerade shaft straight	KA 383/01	KA 383/02	KA 383/03	KA 383/04	KA 383/05	KA 383/06
Schaft aufgebogen shaft curved up	KA 383/09	KA 383/10	KA 383/11	KA 383/12	KA 383/13	KA 383/14



2/1

Bird Beak, Fadenhalter Bird Beak, suture hook forceps	Klassik Griff classic handle		Axialgriff ohne Sperre axial handle w/o ratchet		Zigarrengriff cigar handle	
	basic	advanced	basic	advanced	basic	advanced
155 mm Schaft gerade, Maul 45° links gew. shaft straight, jaw 45° angled left	KA 383/33	KA 383/34	KA 383/35	KA 383/36	KA 383/37	KA 383/38
Schaft gerade, Maul 45° rechts gew. shaft straight, jaw 45° angled right	KA 383/41	KA 383/42	KA 383/43	KA 383/44	KA 383/45	KA 383/46



2/1

Bird Beak, Fadenhalter, kurzes Maul Bird Beak, suture hook forceps, short jaw	Klassik Griff classic handle		Axialgriff ohne Sperre axial handle w/o ratchet		Zigarrengriff cigar handle	
	basic	advanced	basic	advanced	basic	advanced
155 mm Schaft gerade, Maul 45° links gew. shaft straight, jaw 45° angled left	KA 383/57	KA 383/58	KA 383/59	KA 383/60	KA 383/61	KA 383/62
Schaft gerade, Maul 45° rechts gew. shaft straight, jaw 45° angled right	KA 383/65	KA 383/66	KA 383/67	KA 383/68	KA 383/69	KA 383/70



2/1

Bird Beak, Fadenhalter, Maul aufgewinkelt Bird Beak, suture hook forceps, upbiter	Klassik Griff classic handle		Axialgriff ohne Sperre axial handle w/o ratchet		Zigarrengriff cigar handle	
	basic	advanced	basic	advanced	basic	advanced
155 mm Schaft gerade, Maul 20° aufgew. shaft straight, jaw 20° upbiter	KA 383/81	KA 383/82	KA 383/83	KA 383/84	KA 383/85	KA 383/86
Schaft gerade, Maul 40° aufgew. shaft straight, jaw 40° upbiter	KA 383/89	KA 383/90	KA 383/91	KA 383/92	KA 383/93	KA 383/94

ARTHROSKOPIE ARTHROSCOPY ARTROSCOPIA ARTHROSCOPIE ARTROSCOPIA

Fadenhalter
Suture hook Instruments
Portahilos
Pincès à sutures „crochet“
Portafiletto

SCHULTER / SHOULDER

AA

AB

AC

AD

AE

AF

AK

KA

KA
arthro

X

KYE

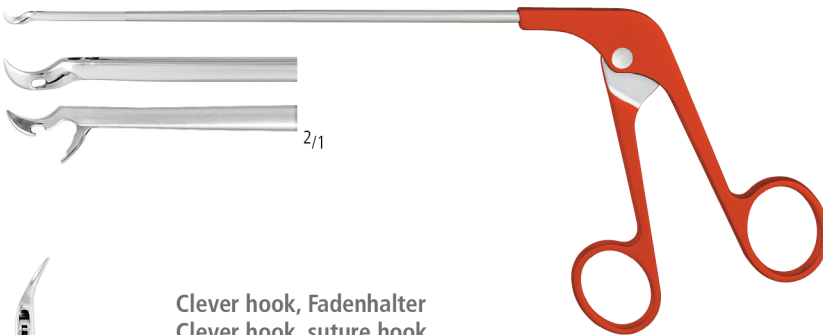

2/1

Clever hook, Fadenhalter
Clever hook, suture hook

155 mm

Schaft gerade, rechts
shaft straight, right

Klassik Griff, grün
classic handle, green

basic

advanced

Zigarrengriff, grün
cigar handle, green

basic

advanced

KA 385/01

KA 385/02

KA 385/03

KA 385/04



2/1

Clever hook, Fadenhalter
Clever hook, suture hook

155 mm

Schaft gerade, links
shaft straight, left

Klassik Griff, rot
classic handle, red

basic

advanced

Zigarrengriff, rot
cigar handle, red

basic

advanced

KA 385/13

KA 385/14

KA 385/15

KA 385/16

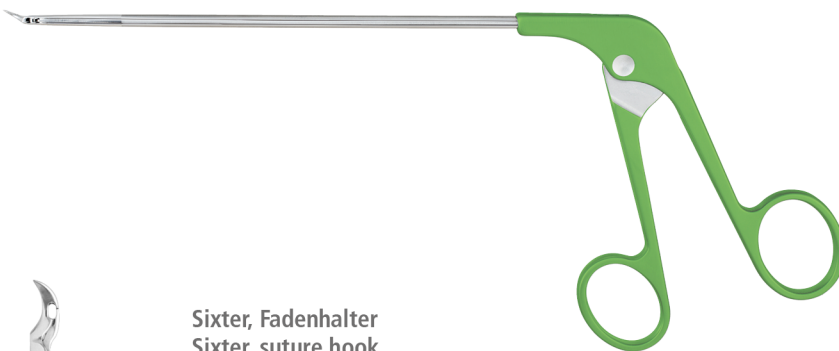

2/1

Sixter, Fadenhalter
Sixter, suture hook

155 mm

Schaft gerade, rechts
shaft straight, right

Klassik Griff, grün
classic handle, green

basic

advanced

Zigarrengriff, grün
cigar handle, green

basic

advanced

KA 385/25

KA 385/26

KA 385/27

KA 385/28



2/1

Sixter, Fadenhalter
Sixter, suture hook

155 mm

Schaft gerade, links
shaft straight, left

Klassik Griff, rot
classic handle, red

basic

advanced

Zigarrengriff, rot
cigar handle, red

basic

advanced

KA 385/37

KA 385/38

KA 385/39

KA 385/40



Fadengreifer
Suture grasper
Pinzas de agarre para sutura
Pincas à saisir les fils
Pinze prendifilo



Fadengreifer, gerieft
suture grasper, serrated

155 mm

Schaft gerade
shaft straight

2/1

Klassik Griff
classic handle

Sperrengriff
slide-lock handle

Axialgriff mit Sperre
axial handle with ratchet

basic	advanced	basic	advanced	basic	advanced
KA 386/01	KA 386/02	KA 386/03	KA 386/04	KA 386/05	KA 386/06



Fadengreifer, gerieft
suture grasper, serrated

155 mm

Schaft gerade, Maul 45° links gew.
shaft straight, jaw 45° angled left

2/1

Schaft gerade, Maul 45° rechts gew.
shaft straight, jaw 45° angled right

Klassik Griff
classic handle

Sperrengriff
slide-lock handle

Axialgriff mit Sperre
axial handle with ratchet

basic	advanced	basic	advanced	basic	advanced
KA 386/17	KA 386/18	KA 386/19	KA 386/20	KA 386/21	KA 386/22
KA 386/25	KA 386/26	KA 386/27	KA 386/28	KA 386/29	KA 386/30



Fadengreifer, gerieft, Maul aufgew.
suture grasper, serrated, upbiter

155 mm

Schaft gerade
shaft straight

2/1

Klassik Griff
classic handle

Sperrengriff
slide-lock handle

Axialgriff mit Sperre
axial handle with ratchet

basic	advanced	basic	advanced	basic	advanced
KA 386/49	KA 386/50	KA 386/51	KA 386/52	KA 386/53	KA 386/54



Fadengreifer, kreuzgerieft
suture grasper, cross serrated

155 mm

Schaft gerade
shaft straight

2/1

Klassik Griff
classic handle

Sperrengriff
slide-lock handle

Axialgriff mit Sperre
axial handle with ratchet

basic	advanced	basic	advanced	basic	advanced
KA 386/65	KA 386/66	KA 386/67	KA 386/68	KA 386/69	KA 386/70



Fadengreifer, atraumatisch
suture grasper, atraumatic

155 mm

Schaft gerade
shaft straight

2/1

Klassik Griff
classic handle

Sperrengriff
slide-lock handle

Axialgriff mit Sperre
axial handle with ratchet

basic	advanced	basic	advanced	basic	advanced
KA 386/81	KA 386/82	KA 386/83	KA 386/84	KA 386/85	KA 386/86

Fasszangen, Fadenschneider
 Grasping forceps, suture cutter
 Pinzas de agarre, cortahilos
 Pincas à préhension, coupe-fils
 Pinze da presa, tagliafilo

SCHULTER / SHOULDER

AA
AB
AC
AD
AE
AF
AK
KA
KA
X
KYE



2/1

Gewebefasszange
tissue grasping forceps

155 mm

Schaft gerade
 shaft straight

Sperrengriff
 slide-lock handle

basic

advanced

Axialgriff mit Sperre
 axial handle with ratchet

basic

advanced

KA 388/01

KA 388/02

KA 388/03

KA 388/04



2/1

Fasszange mit Löffel, gezahnt
grasping forceps cupped, serrated

155 mm

Schaft gerade
 shaft straight

Maulbreite
 jaw width

3,4 mm

Sperrengriff
 slide-lock handle

basic

advanced

Axialgriff mit Sperre
 axial handle with ratchet

basic

advanced

KA 388/13

KA 388/14

KA 388/15

KA 388/16



2/1

Fadenschneider
suture cutter

155 mm

Schaft gerade
 shaft straight

Klassik Griff
 classic handle

basic

advanced

KA 389/01

KA 389/02



2/1

Fadenschneider
suture cutter

155 mm

Schaft gerade
 shaft straight

Griff mit Positionierung
 handle with positioning

basic

advanced

KA 389/17

KA 389/18





ARTHROSKOPIE ARTHROSCOPY ARTROSCOPIA ARTHROSCOPIE ARTROSCOPIA

Fadenschneider, Fadenmanipulator
 Suture cutter, suture manipulator
 Cortahilos, manipulador de hilo
 Coupe-fils, manipulateurs de fils
 Tagliafilo, manipolatore di sutura

Der Fadenschneider wurde entwickelt, um an schwer zugänglichen Bereichen, einen Faden blind zu schneiden. Er ist in zwei verschiedenen Ausführungen erhältlich. Die geschlossene Form verhindert ein Durchschneiden des Knotens. Die V-Form erleichtert durch ihre offene Spitze das Abschneiden von Fäden im Gelenk, ohne dass der Fadenschneider von oben eingeführt werden muss.

The suture cutter has been designed to cut a thread blindly in areas that are difficult to access. It is available in two different designs. The closed form prevents the knot being cut. The V-shaped design has an open tip to make it easier to cut thread in the joint without having to insert the suture cutter from above.



Fadenschneider, geschlossen
 suture cutter, closed

155 mm

Schaft gerade
 shaft straight

2/1

Griff mit Positionierung
 handle with positioning

Axialgriff ohne Sperre
 axial handle w/o ratchet

basic advanced basic advanced

KA 389/25 KA 389/26 KA 389/27 KA 389/28



Fadenschneider, V-Form
 suture cutter, V-shape

155 mm

Schaft gerade
 shaft straight

2/1

Griff mit Positionierung
 handle with positioning

Axialgriff ohne Sperre
 axial handle w/o ratchet

basic advanced basic advanced

KA 389/37 KA 389/38 KA 389/39 KA 389/40



Fadenmanipulator
 suture manipulator

155 mm

Schaft gerade
 shaft straight

2/1

Klassik Griff
 classic handle

Axialgriff ohne Sperre
 axial handle w/o ratchet

basic advanced basic advanced

KA 389/49 KA 389/50 KA 389/51 KA 389/52

Fadenschieber, Nitinol-Nadel
 Suture passer, Nitinol needle
 Pasahilos, aguja de Nitinol
 Passe-fils pour suture, aiguille en Nitinol
 Passafilo, ago Nitinol

SCHULTER / SHOULDER

AA

AB

AC

AD

AE

AF

AK

KA

KA
arthro

X

KYE

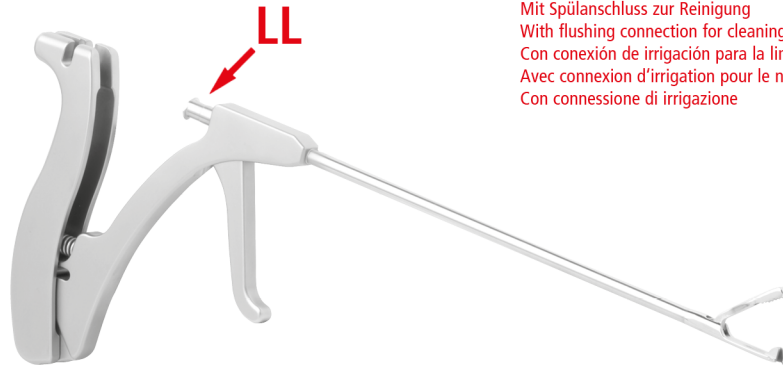

Mit Spülanschluss zur Reinigung
 With flushing connection for cleaning
 Con conexión de irrigación para la limpieza
 Avec connexion d'irrigation pour le nettoyage
 Con connessione di irrigazione

Fadenschieber Ø 6 mm
 suture passer Ø 6 mm

170 mm

vordere Öffnung
 front-opening

KA 390/01

seitliche Öffnung
 side-opening

KA 390/03

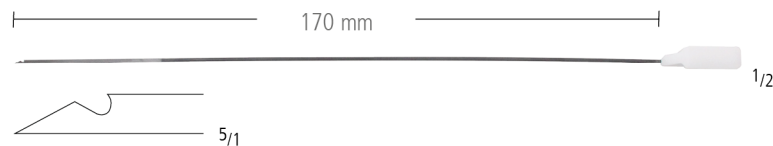

Nitinol-Nadel für Fadenschieber KA 390/01 und KA 390/03
 Nitinol needle for suture passer KA 390/01 and KA 390/03

Ø 0,3 mm
 Ø 0.3 mm

KA 390/10

HÜFT-INSTRUMENTE
HIP INSTRUMENTS
INSTRUMENTOS DE CADERA
INSTRUMENTS POUR LA HANCHE
STRUMENTI PER L'ANCA



nopa[®] instruments



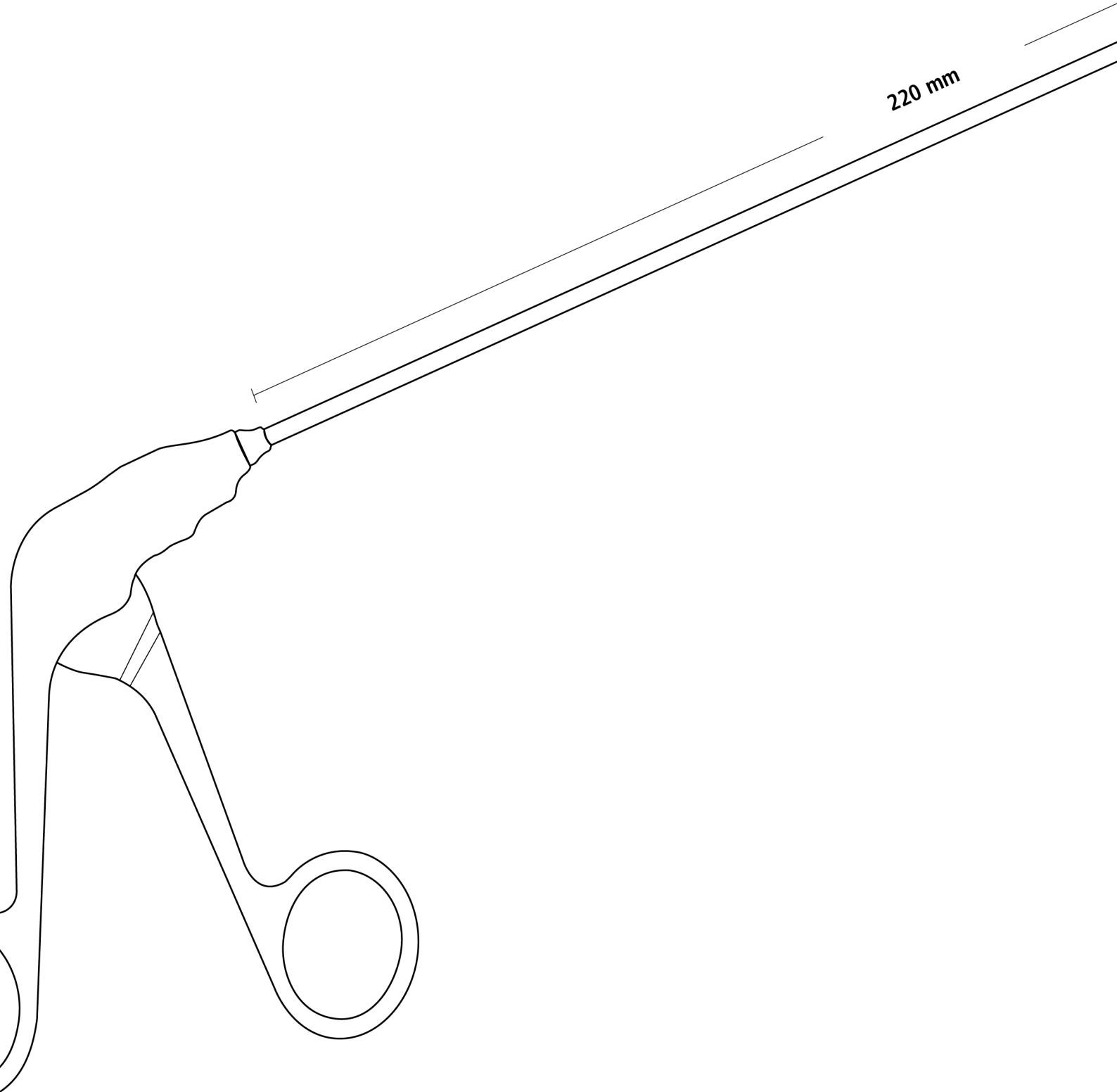

GRIFFE / HANDLES

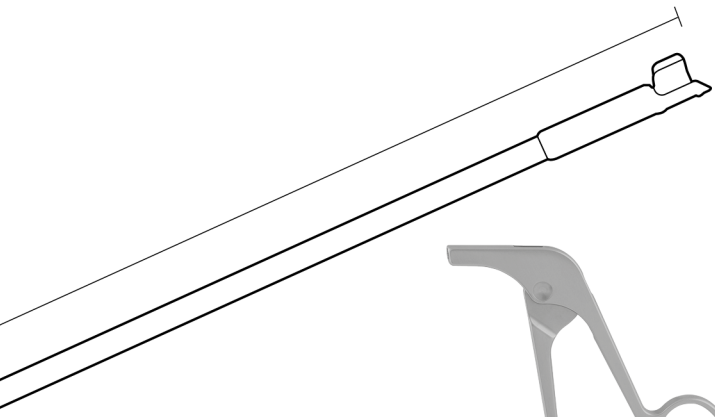

Klassik Griff
classic handle



Sperrengriff
slide-lock handle



Rotierbarer Ringgriff
rotatable handle



Rotierbarer Axialgriff
rotatable axial handle

SCHÄFTE / SHAFTS

basic



advanced

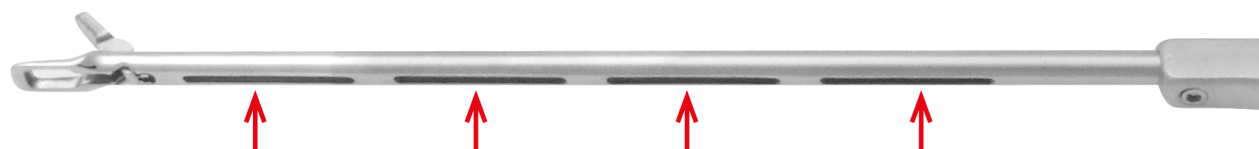

SET**ZS 983/04**

suggested basic set for hip arthroscopy



Art.No.	description	qty.	page
KA 300/11	RING CURETTE, 3.0 MM, 30° ANGLED, 220 MM, KNURLED HANDLE	1	46
KA 300/19	HOOK PROBE, 3.5 MM, GRADUATED, 220 MM, KNURLED HANDLE	1	46
KA 300/30	CARTILAGE RASP, FINE, 220 MM, KNURLED HANDLE	1	46
KA 300/31	CARTILAGE RASP, HEAVY, 220 MM, KNURLED HANDLE	1	46
KA 393/01*	PUNCH SLIM, STRAIGHT, 220 MM, CLASSIC HANDLE	1	116
KA 393/33*	PUNCH SLIM, JAW 45° CURVED DOWN LEFT, STRAIGHT, 220 MM, CLASSIC HANDLE	1	116
KA 393/37*	PUNCH SLIM, JAW 45° CURVED DOWN RIGHT, STRAIGHT, 220 MM, CLASSIC HANDLE	1	116
KA 393/49*	DUCKLY PUNCH MEDIUM, STRAIGHT, 220 MM, CLASSIC HANDLE	1	116
KA 393/53*	DUCKLY PUNCH MEDIUM, CURVED UP, 220 MM, CLASSIC HANDLE	1	116
KA 395/01*	BACKBITER, LEFT CUT, STRAIGHT, 220 MM, CLASSIC HANDLE	1	117
KA 396/01*	GRASPING FORCEPS 1X2 TEETH, STRAIGHT, 220 MM, SLIDE-LOCK HANDLE	1	118
KA 396/25*	GRASPING FORCEPS ALLIGATOR, STRAIGHT, 220 MM, SLIDE-LOCK HANDLE	1	118
XP 701/43	HD ARTHROSCOPE Ø 4.0 MM, 30°, 175 MM, AUTOCLAVABLE	1	124
XK 709/12	UNIVERSAL SHEATH FOR OPTIC Ø 4.0 MM, 175 MM, 2 STOPCOCKS	1	124
XK 710/11	TROCAR, SHARP	1	125
XK 710/12	OBTURATOR, BLUNT	1	125

***basic shaft**



SET

ZS 983/14

suggested advanced set for hip arthroscopy



Art.No.	description	qty.	page
KA 300/11	RING CURETTE, 3.0 MM, 30° ANGLED, 220 MM, KNURLED HANDLE	1	46
KA 300/19	HOOK PROBE, 3.5 MM, GRADUATED, 220 MM, KNURLED HANDLE	1	46
KA 300/30	CARTILAGE RASP, FINE, 220 MM, KNURLED HANDLE	1	46
KA 300/31	CARTILAGE RASP, HEAVY, 220 MM, KNURLED HANDLE	1	46
KA 393/02*	PUNCH SLIM, STRAIGHT, 220 MM, CLASSIC HANDLE, ADVANCED	1	116
KA 393/34*	PUNCH SLIM, JAW 45° CURVED DOWN LEFT, STRAIGHT, 220 MM, CLASSIC HANDLE, ADVANCED	1	116
KA 393/38*	PUNCH SLIM, JAW 45° CURVED DOWN RIGHT, STRAIGHT, 220 MM, CLASSIC HANDLE, ADVANCED	1	116
KA 393/50*	DUCKLY PUNCH MEDIUM, STRAIGHT, 220 MM, CLASSIC HANDLE, ADVANCED	1	116
KA 393/54*	DUCKLY PUNCH MEDIUM, CURVED UP, 220 MM, CLASSIC HANDLE, ADVANCED	1	116
KA 395/02*	BACKBITER, LEFT CUT, STRAIGHT, 220 MM, CLASSIC HANDLE, ADVANCED	1	117
KA 396/02*	GRASPING FORCEPS 1X2 TEETH, STRAIGHT, 220 MM, SLIDE-LOCK HANDLE, ADVANCED	1	118
KA 396/26*	GRASPING FORCEPS ALLIGATOR, STRAIGHT, 220 MM, SLIDE-LOCK HANDLE, ADVANCED	1	118
XP 701/43	HD ARTHROSCOPE Ø 4.0 MM, 30°, 175 MM, AUTOCLAVABLE	1	124
XK 709/12	UNIVERSAL SHEATH FOR OPTIC Ø 4.0 MM, 175 MM, 2 STOPCOCKS	1	124
XK 710/11	TROCAR, SHARP	1	125
XK 710/12	OBTURATOR, BLUNT	1	125

*advanced shaft

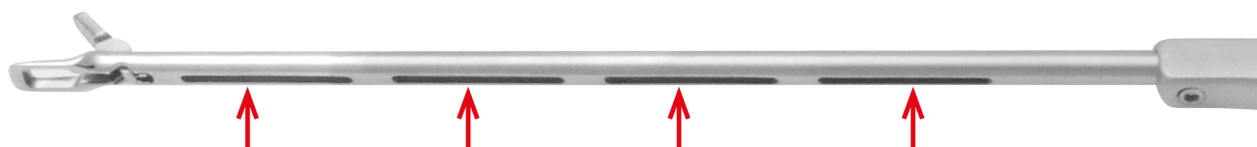



ARTHROSKOPIE ARTHROSCOPY ARTROSCOPIA ARTHROSCOPIE ARTROSCOPIA

- Stanzen
- Punches
- Punzones
- Pinces emporte-pièces
- Pinze

Diese Auswahl an Instrumenten wurde speziell für den Bereich der **Hüfte** zusammengestellt. Lange Schäfte mit einem schlanken Profil bieten einen idealen Zugang in das Hüftgelenk.

This selection of instruments has been put together specifically for the **hip** area. Long shafts with a slim profile offer ideal access to the hip joint.



Stanze, schmal punch, slim	Schnittbreite cutting width	Klassik Griff classic handle	
		basic	advanced
220 mm Schaft gerade shaft straight	1,8 mm	KA 393/01	KA 393/02



Stanze, schmal, Maul aufgewinkelt punch, slim, upbiter	Schnittbreite cutting width	Klassik Griff classic handle	
		basic	advanced
220 mm Schaft gerade shaft straight	1,8 mm	KA 393/17	KA 393/18



Stanze, schmal punch, slim	Schnittbreite cutting width	Klassik Griff classic handle	
		basic	advanced
220 mm Schaft gerade, Maul 45° links abgewinkelt shaft straight, jaw 45° curved down left	1,8 mm	KA 393/33	KA 393/34

Schaft gerade, Maul 45° rechts abgewinkelt shaft straight, jaw 45° curved down right	1,8 mm	KA 393/37	KA 393/38
---	--------	------------------	------------------



Duckly-Stanze, medium Duckly punch, medium	Schnittbreite cutting width	Klassik Griff classic handle	
		basic	advanced
220 mm Schaft gerade shaft straight	3,2 mm	KA 393/49	KA 393/50

Schaft aufgebogen shaft curved up	3,2 mm	KA 393/53	KA 393/54
--------------------------------------	--------	------------------	------------------

ARTHROSKOPIE ARTHROSCOPY ARTROSCOPIA ARTHROSCOPIE ARTROSCOPIA

Stanzen, Rückwärtsschneider, Löffelzangen, Dreh-Stanzen
 Punches, backbiter, rongeurs, rotary basket punches
 Punzones, backbiter, pinzas de cuchara, punzones rotativos
 Pincas emporte-pièces, coupe rétrograde, rongeurs, pincas emporte-pièces rotatives
 Pinze, taglierina inversa, pinze a cucchiaio, pinze girevoli

HÜFTE / HIP

AA

AB

AC

AD

AE

AF

AK

KA

KA
arthro

X

KYE



2/1

**Duckly-Stanze, medium,
Maul aufgewinkelt
Duckly punch, medium, upbiter**

**Schnittbreite
cutting width**

**Klassik Griff
classic handle**

220 mm

Schaft gerade
shaft straight

3,2 mm

basic

advanced

KA 393/65

KA 393/66



2/1

**Rückwärtsschneider
backbiter**

**Schnittbreite
cutting width**

**Klassik Griff
classic handle**

220 mm

Schaft gerade, Schnitt links
shaft straight, left cut

2,3 mm

basic

advanced

KA 395/01

KA 395/02

Schaft gerade, Schnitt rechts
shaft straight, right cut

2,3 mm

KA 395/05

KA 395/06



2/1

**Löffelzange
rongeur**

**Klassik Griff
classic handle**

220 mm

Schaft gerade
shaft straight

basic

advanced

KA 395/17

KA 395/18



2/1

**Dreh-Stanze
rotary punch**

**Schnittbreite
cutting width**

**Rotierbarer Ringgriff
rotatable handle**

**Rotierbarer Axialgriff
rotatable axial handle**

220 mm

Schaft gerade,
Maul 90° links gewinkelt
shaft straight, jaw 90° angled left

2,2 mm

KA 395/25

KA 395/26

KA 395/27

KA 395/28

Schaft gerade,
Maul 90° rechts gewinkelt
shaft straight, jaw 90° angled right

2,2 mm

KA 395/31

KA 395/32

KA 395/33

KA 395/34



Fasszangen
Grasping forceps
Pinzas de agarre
Pincas à préhension
Pinze da presa



Fasszange, 1x2 Zähne
grasping forceps, 1x2 teeth

220 mm

Schaft gerade
shaft straight

Sperrengriff
slide-lock handle

basic advanced

KA 396/01 KA 396/02

2/1



Fasszange mit Löffel, gezahnt
grasping forceps cupped, serrated

220 mm

Schaft gerade
shaft straight

Maulbreite
jaw width

Sperrengriff
slide-lock handle

basic advanced

2,7 mm

KA 396/09 KA 396/10

Schaft gerade
shaft straight

3,4 mm

KA 396/13 KA 396/14

2/1



Alligator Fasszange
Alligator grasping forceps

220 mm

Schaft gerade
shaft straight

Sperrengriff
slide-lock handle

basic advanced

KA 396/25 KA 396/26

2/1

ENDOSKOPIE
ENDOSCOPY
ENDOSCOPIA
ENDOSCOPIE
ENDOSCOPIA



Spülkanülen	Seite	120
Irrigation cannula	Page	120
Canula de irrigación	Página	120
Canule d'irrigation	Page	120
Cannule di irrigazione	Pagina	120
Arthroskope und Arthroskopieschäfte	Seite	121-125
Arthroscopes and arthroscopic sheaths	Page	121-125
Artroscopios y vainas de artroscopios	Página	121-125
Arthroscopes et chemises d'arthroscopie	Page	121-125
Artroscopia e camicie	Pagina	121-125
Arthroskopieelektroden, Anschlusskabel	Seite	126-127
Arthroscopic electrodes, connection cords	Page	126-127
Electrodos de artroscopia, cables de conexión	Página	126-127
Électrodes d'arthroscopie, cables de raccordement	Page	126-127
Elettrodi per artroscopia e cavi	Pagina	126-127
Kaltlichtkabel, Adapter	Seite	128
Fibre optic cable, adapter	Page	128
Cable de fibra óptica, adaptador	Página	128
Cordons de lumière froide, adaptateurs	Page	128
Cavo fibra ottica, adattatori	Pagina	128
Geräte	Seite	129-131
Equipment	Page	129-131
Equipos	Página	129-131
Équipements	Page	129-131
Equipaggiamento	Pagina	129-131

Weitere Endoskopie-Instrumente finden Sie in unserem Katalog „**Endoskopie**“.

For further endoscopic instruments kindly refer to our catalogue „**Endoscopy**“.

Para instrumental de endoscopia adicional, consulte nuestro catálogo de „**Endoscopia**“.

Pour d'autres instruments d'endoscopie, veuillez consulter notre catalogue „**Endoscopie**“.

Per ulteriori strumenti di endoscopia, consultate il nostro catalogo „**Endoscopia**“.



Spülkanülen
 Irrigation cannula
 Canula de irrigación
 Canule d'irrigation
 Cannule di irrigazione

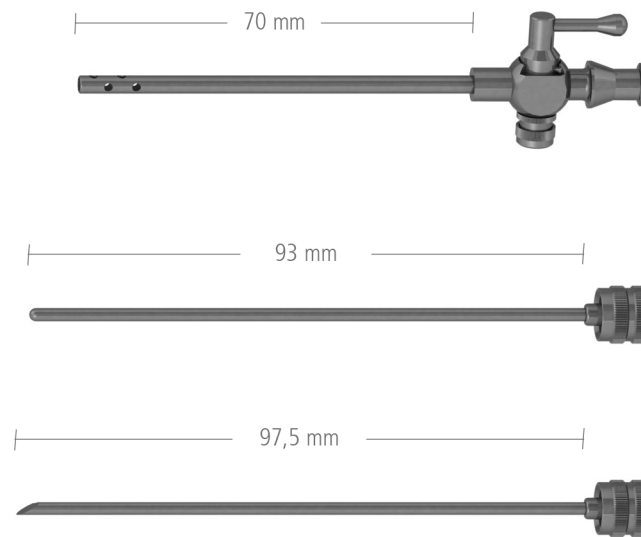

Spülkanüle komplett, bestehend aus:
irrigation cannula complete, consisting of:

XK 665/00

Spülkanüle Ø 4,5 mm
 irrigation cannula Ø 4.5 mm

XK 665/01

Obturator
 Obturator

XK 665/02

Trokar
 trocar

XK 665/03

ENDOSKOPIE ENDOSCOPY ENDOSCOPIA ENDOSCOPIE ENDOSCOPIA

Arthroskope, Arthroskopieschäfte
 Arthroscopes, arthroscopic sheaths
 Artroscopios y vainas de artroscopios
 Arthroscopes et chemises d'arthroscopie
 Artroscopia e camicie

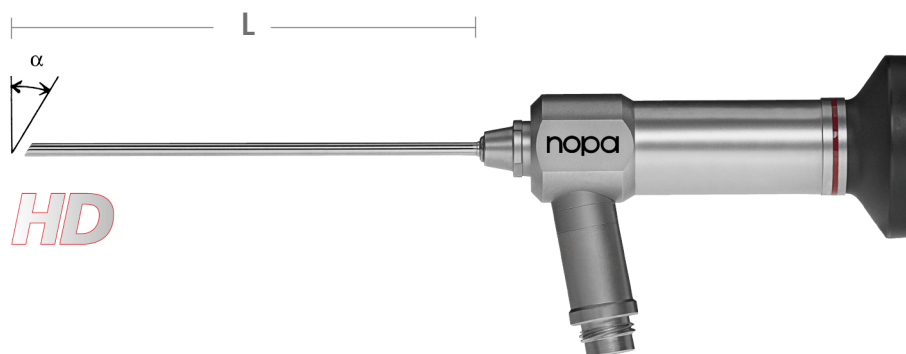

HD-Arthroskop Ø 2,0 mm, autoklavierbar
 HD arthroscope Ø 2.0 mm, autoclavable

	L = 58 mm	L = 104 mm
$\alpha=0^\circ$	XP 706/20	XP 708/20
$\alpha=30^\circ$	XP 706/30	XP 708/30



Arthroskopieschäfte
 arthroscopic sheaths

mit zwei drehbaren Hähnen
 with two rotating stopcocks

mit einem drehbaren Hahn
 with one rotating stopcock

für Optiklänge
 for optic length

	L = 58 mm	L = 104 mm
universal	XK 709/52	XK 709/72
universal	XK 709/51	XK 709/71

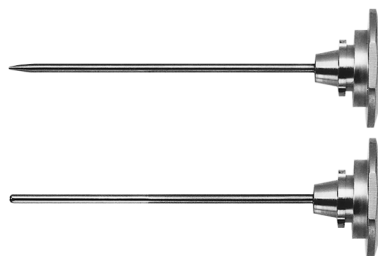

Trokar / Obturator
 trocar / obturator

Trokar, konisch
 trocar, conical

Obturator, stumpf
 obturator, blunt

für Optiklänge
 for optic length

	L = 58 mm	L = 104 mm
	XK 710/51	XK 710/71
	XK 710/52	XK 710/72

AA
 AB
 AC
 AD
 AE
 AF
 AK
 KA
 KA_{arthro}
 X
 KYE

X ENDOSKOPIE ENDOSCOPY ENDOSCOPIA ENDOSCOPIE ENDOSCOPIA

Arthroskope, Arthroskopieschäfte
 Arthroscopes, arthroscopic sheaths
 Artroscopios y vainas de artroscopios
 Arthroscopes et chemises d'arthroscopie
 Artroscopia e camicie

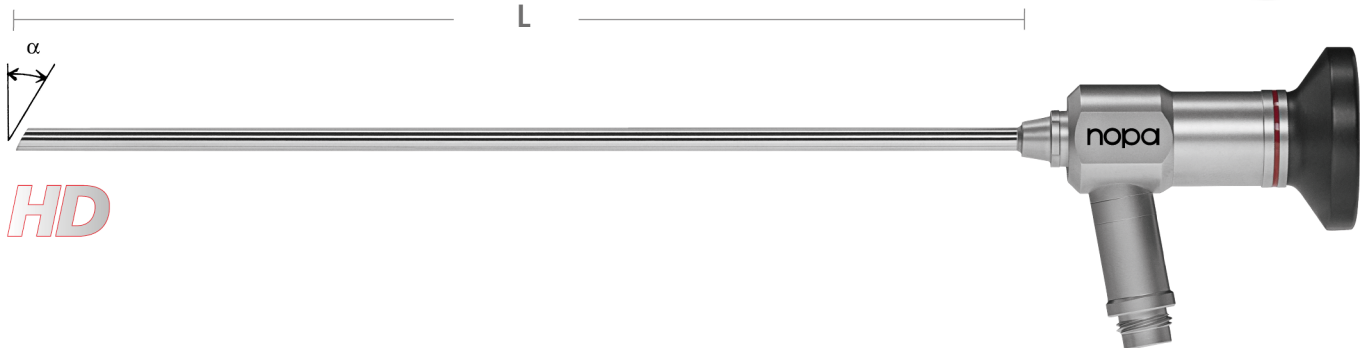

HD

HD-Arthroskop Ø 2,7 mm, autoklavierbar
 HD arthroscope Ø 2.7 mm, autoclavable

	L = 175 mm	L = 110 mm
$\alpha=0^\circ$	XP 700/30	XP 704/30
$\alpha=30^\circ$	XP 700/33	XP 704/33
$\alpha=70^\circ$	XP 700/37	XP 704/37

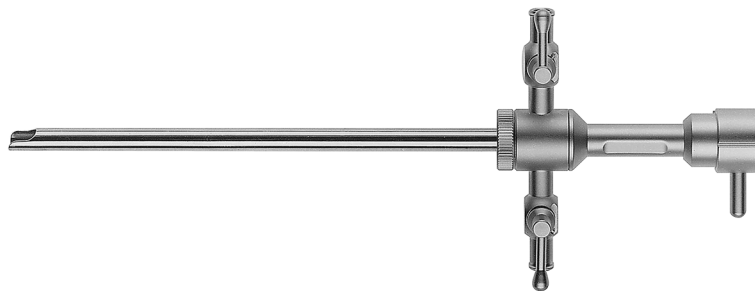

Arthroskopieschäfte mit zwei drehbaren Hähnen
 arthroscopic sheaths with two rotating stopcocks

	L = 175 mm	L = 110 mm
für Optiklänge for optic length		
universal	XK 709/02	XK 709/32
30° only	XK 709/06	XK 709/36



Arthroskopieschäfte mit einem drehbaren Hahn
 arthroscopic sheaths with one rotating stopcock

	L = 175 mm	L = 110 mm
für Optiklänge for optic length		
universal	XK 709/01	XK 709/31
30° only	XK 709/05	XK 709/35

ENDOSKOPIE ENDOSCOPY ENDOSCOPIA ENDOSCOPIE ENDOSCOPIA

Arthroskope, Arthroskopieschäfte
 Arthroscopes, arthroscopic sheaths
 Artroscopios y vainas de artroscopios
 Arthroscopes et chemises d'arthroscopie
 Artroscopia e camicie

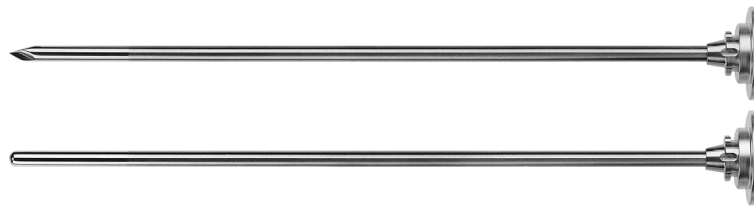

Trokar / Obturator trocar / obturator	für Optiklänge for optic length	L = 175 mm	L = 110 mm
Trokar, spitz trocar, sharp		XK 710/01	XK 710/31
Obturator, stumpf obturator, blunt		XK 710/02	XK 710/32

High Flow

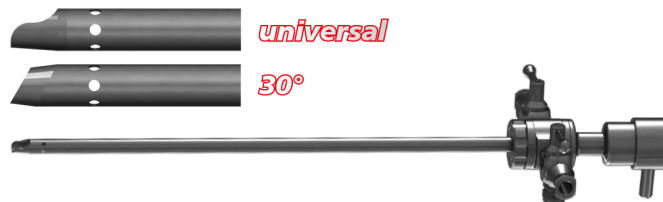

High Flow Arthroskopieschäfte high flow arthroscopic sheaths	für Optiklänge for optic length	L = 175 mm
mit zwei drehbaren Hähnen with two rotating stopcocks	universal	XK 709/07
	30° only	XK 709/08
mit einem drehbaren Hahn with one rotating stopcock	universal	XK 709/09
	30° only	XK 709/10

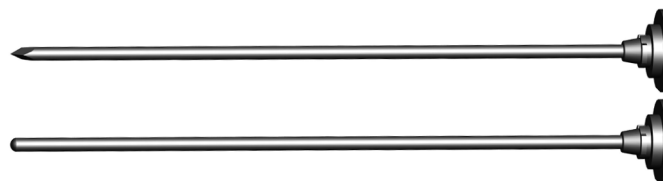

Trokar / Obturator für High Flow Schäfte trocar / obturator for high flow sheaths	für Optiklänge for optic length	L = 175 mm
Trokar, spitz trocar, sharp		XK 710/05
Obturator, stumpf obturator, blunt		XK 710/06

AA

AB

AC

AD

AE

AF

AK

KA

KA
arthro

X

KYE

X ENDOSKOPIE ENDOSCOPY ENDOSCOPIA ENDOSCOPIE ENDOSCOPIA

Arthroskope, Arthroskopieschäfte
 Arthroscopes, arthroscopic sheaths
 Artroscopios y vainas de artroscopios
 Arthroscopes et chemises d'arthroscopie
 Artroscopia e camicie

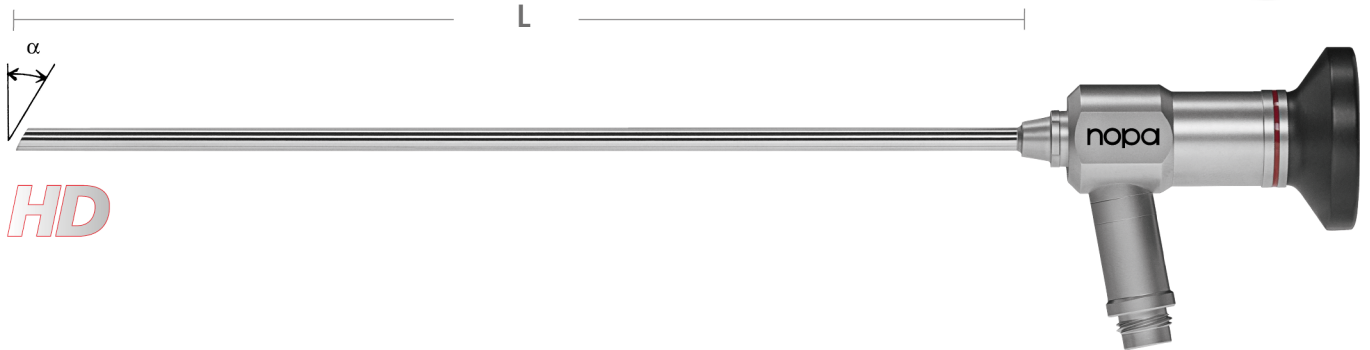

HD

HD-Arthroskop Ø 4,0 mm, autoklavierbar
 HD arthroscope Ø 4.0 mm, autoclavable

L = 175 mm

$\alpha=0^\circ$	XP 701/40
$\alpha=30^\circ$	XP 701/43
$\alpha=45^\circ$	XP 701/45
$\alpha=70^\circ$	XP 701/47 wide angle

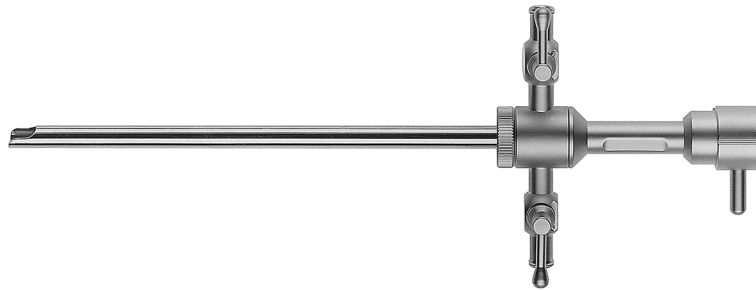

Arthroskopieschäfte mit zwei drehbaren Hähnen
 arthroscopic sheaths with two rotating stopcocks

für Optiklänge
 for optic length

L = 175 mm

universal	XK 709/12
30° only	XK 709/16



Arthroskopieschäfte mit einem drehbaren Hahn
 arthroscopic sheaths with one rotating stopcock

für Optiklänge
 for optic length

L = 175 mm

universal	XK 709/11
30° only	XK 709/15

ENDOSKOPIE ENDOSCOPY ENDOSCOPIA ENDOSCOPIE ENDOSCOPIA

Arthroskope, Arthroskopieschäfte
 Arthroscopes, arthroscopic sheaths
 Artroscopios y vainas de artroscopios
 Arthroscopes et chemises d'arthroscopie
 Artroscopia e camicie

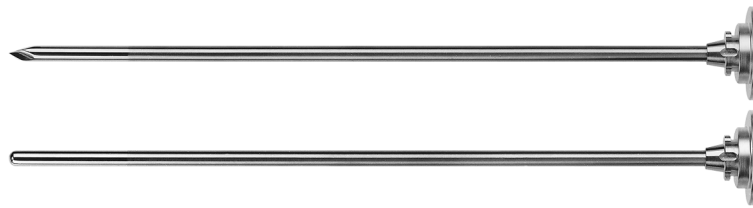

Trokar / Obturator trocar / obturator	für Optiklänge for optic length	L = 175 mm
Trokar, spitz trocar, sharp		XK 710/11
Obturator, stumpf obturator, blunt		XK 710/12

High Flow

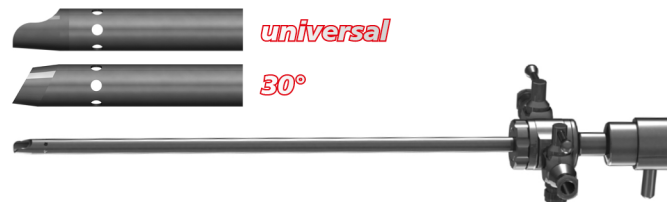

High Flow Arthroskopieschäfte high flow arthroscopic sheaths	für Optiklänge for optic length	L = 175 mm
mit zwei drehbaren Hähnen with two rotating stopcocks	universal	XK 709/17
	30° only	XK 709/18
mit einem drehbaren Hahn with one rotating stopcock	universal	XK 709/19
	30° only	XK 709/20

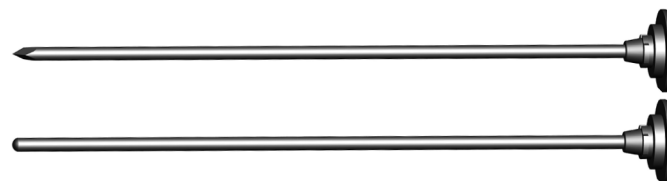

Trokar / Obturator für High Flow Schäfte trocar / obturator for high flow sheaths	für Optiklänge for optic length	L = 175 mm
Trokar, spitz trocar, sharp		XK 710/15
Obturator, stumpf obturator, blunt		XK 710/16

AA

AB

AC

AD

AE

AF

AK

KA

KA_{arthro}

X

KYE

X ENDOSKOPIE ENDOSCOPY ENDOSCOPIA ENDOSCOPIE ENDOSCOPIA

Arthroskopieelektroden, Anschlusskabel
 Arthroscopic electrodes, connection cords
 Electrodo de artroscopia, cables de conexión
 Électrodes d'arthroscopie, cables de raccordement
 Elettrodi per artroscopia e cavi

monopolar







Monopolare Arthroskopieelektroden, mit Handgriff, 5x wiederverwendbar
monopolar arthroscopic electrodes, with handle, 5x reusable



Hakenelektrode, Spitze Ø 0,6 mm, 1,5 mm, 90° abgewinkelt hook electrode, tip Ø 0.6 mm, 1.5 mm, 90° angled	XR 848/01
Hakenelektrode, Spitze Ø 0,6 mm, 4 mm, 90° abgewinkelt hook electrode, tip Ø 0.6 mm, 4 mm, 90° angled	XR 848/02
Nadelelektrode, Spitze Ø 0,6 mm, 2 mm, 45° abgewinkelt needle electrode, tip Ø 0.6 mm, 2 mm, 45° angled	XR 848/03
Messerelektrode, Spitze Ø 1,5 mm, 4 mm, 45° abgewinkelt knife electrode, tip Ø 1.5 mm, 4 mm, 45° angled	XR 848/04
Hakenelektrode, Spitze Ø 1,5 mm, 4 mm, 90° abgewinkelt hook electrode, tip Ø 1.5 mm, 4 mm, 90° angled	XR 848/05



HF-Kabel für monopolare Arthroskopieelektroden
HF cable for monopolar arthroscopic electrodes

	length of cable	3 m	5 m
 MARTIN / BERCHTOLD / INTEGRA		XR 827/03	XR 827/05
 ERBE ACC / ICC / VIO		XR 831/03	XR 831/05
 ERBE T-Serie		XR 837/02	XR 837/06
 VALLEYLAB		XR 838/13	XR 838/15

ENDOSKOPIE ENDOSCOPY ENDOSCOPIA ENDOSCOPIE ENDOSCOPIA

Arthroskopieelektroden, Anschlusskabel
 Arthroscopic electrodes, connection cords
 Electrodo de artroscopia, cables de conexión
 Électrodes d'arthroscopia, cables de raccordement
 Elettrodi per artroscopia e cavi

bipolar

AA

AB

AC

AD

AE

AF

AK

KA





KA
arthro

X

KYE





Bipolare Arthroskopieelektroden, mit Handgriff, 5x wiederverwendbar
bipolar arthroscopic electrodes, with handle, 5x reusable

	L=115 mm	L=170 mm
 Vaporisationselektrode 90° vaporisation electrode 90°	XR 849/01	XR 849/11
 Vaporisationselektrode, 70° abgewinkelt vaporisation electrode, 70° angled	XR 849/02	XR 849/12
 Hakenelektrode, feine Spitze, 90° abgewinkelt hook electrode, fine tip, 90° angled	XR 849/03	
 Hakenelektrode, verstärkte Spitze, 90° abgewinkelt hook electrode, reinforced tip, 90° angled		XR 849/14



HF-Kabel für bipolare Arthroskopieelektroden, 300x wiederverwendbar
HF cable for bipolar arthroscopic electrodes, 300x reusable

	length of cable	3 m	5 m
 VALLEYLAB		XR 839/01	XR 839/11
 MARTIN / BERCHTOLD / INTEGRA		XR 839/02	XR 839/12
 ERBE ACC / ICC / VIO		XR 839/03	XR 839/13

X ENDOSKOPIE ENDOSCOPY ENDOSCOPIA ENDOSCOPIE ENDOSCOPIA

Kaltlichtkabel, Adapter
 Fibre optic cable, adapter
 Cable de fibra óptica, adaptador
 Cordons de lumière froide, adaptateurs
 Cavo fibra ottica, adattatori



Ø /mm	Länge /cm length /cm	
3,5	180	XT 035/18
	230	XT 035/23
	300	XT 035/30
4,5	180	XT 045/18
	230	XT 045/23
	300	XT 045/30

Projektor-Seite
projector side

Endoskop-Seite
endoscope side



XT 100/01
STORZ



XT 100/11

STORZ/WINTER + IBE
OLYMPUS/STRYKER



XT 100/02
HENKE-SASS/WOLF



XT 100/12

HENKE-SASS/WOLF



XT 100/03
ACMI/HEINE



XT 100/13

ACMI/HEINE



XT 100/04
WINTER + IBE



XT 100/05
OLYMPUS

- >> zusätzliche Isolierung >> Metallspirale >> Silikonmantel >> sterilisierbar
- >> additionally insulated >> metal spiral >> silicon tube >> autoclavable

Bestellinformation / ordering information

>> Bitte bestellen Sie Kaltlichtgrundkabel mit 2 Adaptern >> please order the basic fibre optic cable and two adapters

nopa[®] instruments

equipment



nopa bietet folgende Geräte für die Anwendung in der Arthroskopie.
Für weitere Informationen können Sie uns gerne jederzeit kontaktieren.

nopa offers the following equipment for use in arthroscopy.
For further information, please feel free to contact us at any time.

MONITORE / MONITORS

KAMERAS / CAMERAS

KALTLICHTQUELLEN / COLD LIGHT SOURCES

PUMPEN / PUMPS

SAUG- UND SPÜLGERÄTE / SUCTION AND IRRIGATION UNITS

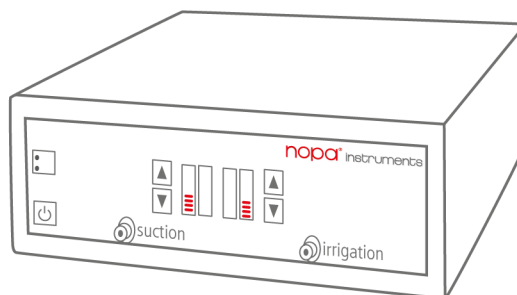
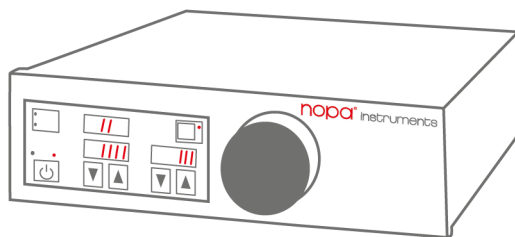
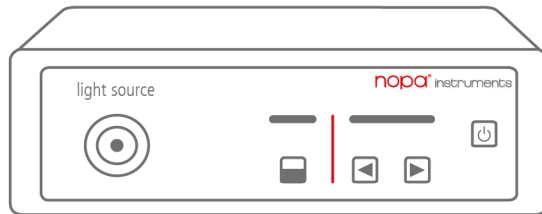
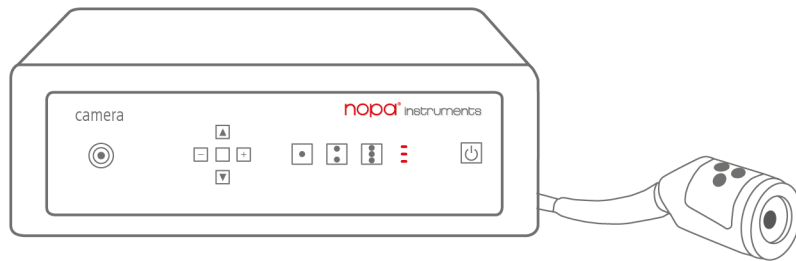

AA

AB

AC

AD

AE

AF

AK

KA

KA
arthro

X

KYE



Container

Unser komplettes Container Programm finden Sie in unserem Katalog „**container und sterilisation**“.

For our complete range of sterilizing containers kindly refer to our catalogue „**container and sterilization**“.

Para nuestra gama de contenedores completa, consulte nuestro catálogo de „**contenedores y esterilización**“.

Pour notre gamme complète de conteneurs, veuillez consulter notre catalogue „**conteneur et stérilisation**“.

Il nostro assortimento completo di container lo trovate nel nostro catalogo „**contenitore e sterilizzazione**“.







napace

Bitte fordern Sie unseren Container Katalog an.
Please ask for our container catalogue.





nopa[®] instruments
traditionally modern

nopa instruments

Medizintechnik GmbH
Weilatten 7-9
78532 Tuttlingen/Germany

Tel. +49 7462 9490-0
Fax +49 7462 9490-90
info@nopa.de
www.nopa.de

Herstellung und Verkauf chirurgischer
und endoskopischer Instrumente.
Manufacture and Sales of Surgical
and Endoscopic Instruments.

