

MEDLANE[®]

Instrumentation
chirurgicale

Instrumentation chirurgicale

MEDLANE[®]

Instrumentation chirurgicale

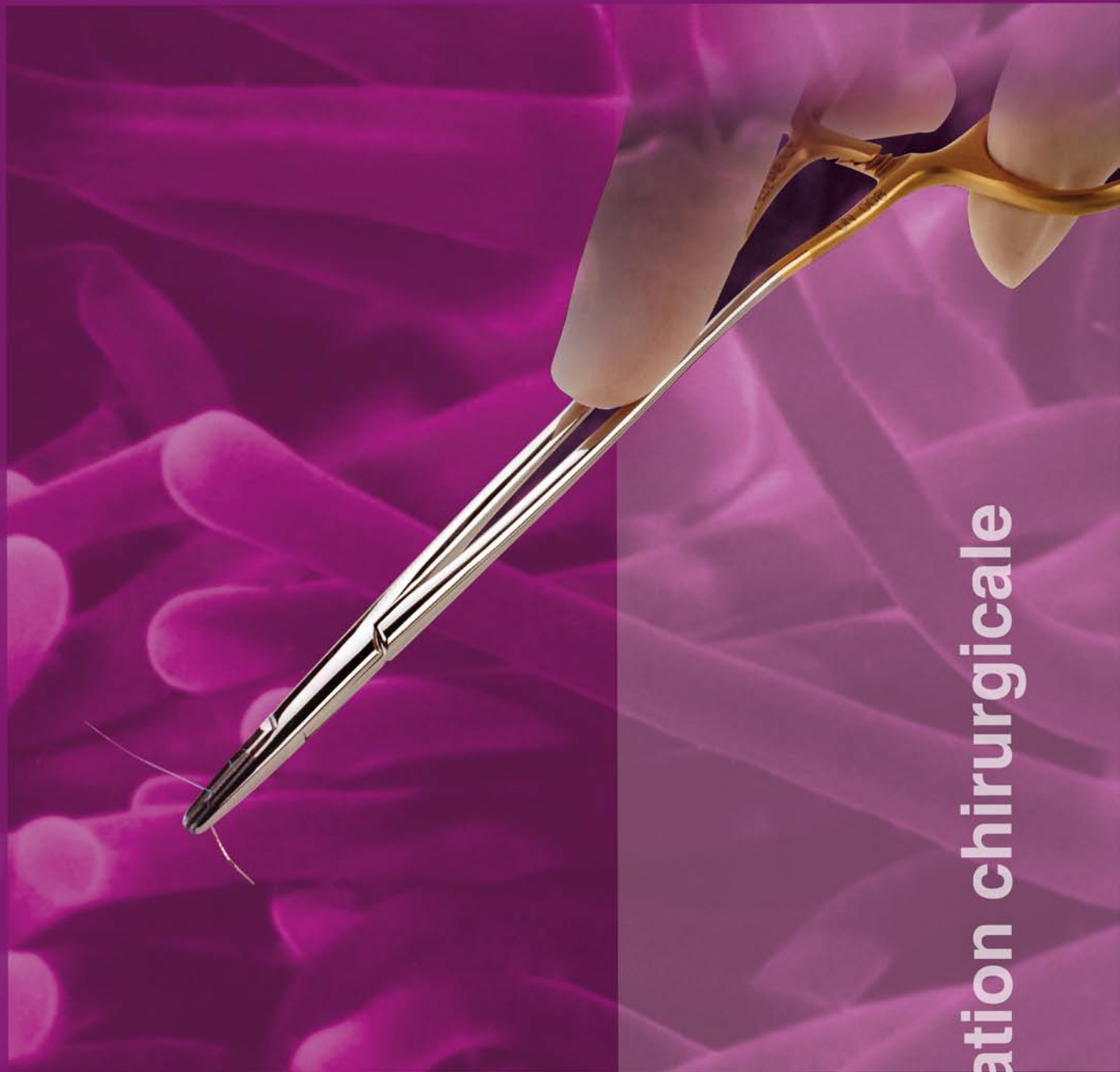

SOMMAIRE GENERAL

A

- INTRODUCTION
- AGRAFES MICHEL 1-2
- AIGUILLES 4-12
- ALENE 12
- AMNIOSCOPE 13
- AMPLIGREFFE 13
- AMYGDALOTOMES 15
- ANNEAUX POUR ENDARTERIECTOMIE 17
- ANSES AURICULAIRES 17
- ANUSCOPES 17-18

B

- BISTOURIS 20
- BOUGIES - DILATATEURS 22
- BROSSE A ONGLES 24

C

- CADRE PORTE-INSTRUMENTS 26
- CANULES 26-28
- CHASSE GREFFONS 29
- CHAUSSE VEINE 29
- CISAILLES 30
- CISEAUX 32-65
- CISEAUX A OS 67-82
- CLAMPS BULLDOG 86-89
- CLAMPS DIGESTIFS 91-96
- CLAMPS VASCULAIRES 98-121
- CLIPS 124-127
- COSTOTOMES 130-132
- COUTEAUX 134-137
- CROCHETS 139-144
- CURETTES 146-158

D

- DAVIER A OS 162-166
- DILATATEURS 168-169
- DISSECTEURS SUR MANCHE 171-173

E

- ECARTEURS 175-242
- ECRASEURS INTESTINAUX 244
- ELEVATEURS 245-246
- ETRIERS 247

F-L

- FORCEPS OBSTETRIKAUX 250-253
- HYSTEROMETRES 255
- LAMES MALLEABLES 256

M-O

- MAILLETS 258
- MASSES 258
- MAIN DE PLOMB 258
- MANDRIN 258
- OUVRE BOUCHES 260-263

P

- PASSE-FILS 266-272
- PERFORATEURS 274
- PINCES 275-393
- POINTES CARREES 395
- PORTE-AIGUILLES 397-408
- PORTE-COTON 410

R

- RAPES - ORL - OSSEUSES 414-415
- RAPPROCHEURS COSTAUX 416
- RONGEURS 418-428
- RUGINES 430-440

S

- SCIES 443-445
- SEMELLES 447
- SERRE-FILS 447
- SERRE NOEUDS 448-449
- SONDES 451-452
- SPATULES 453
- SPECULUMS 445-461
- STYLETS 462

T-V

- TIRE COMEDON 464
- TIRE FIBROME 464
- TIRE PAPILLE 464
- TOURNIQUETS VASCULAIRES 465
- TREPANS 467-469
- VALVES 471-477

- INDEX

Pour la précision du geste



Certifiée ISO 9001 et ISO 13485
 Conception, fabrication et commercialisation
 d'instruments de chirurgie.
 Distribution de containers de stérilisation.



MODE D'EMPLOI DE NOTRE CATALOGUE



AG

Classés par famille d'instrument →

AGRAFES MICHEL

PINCES A POSER ←

Utilisation



nom d'auteur ou fonction classé par ordre alphabétique

MICHEL
AG 002 02 130 mm
AG 002 03 160 mm

Référence Medlane

AG 002 03

Rappel des 2 premières lettres de la famille d'instruments. Facultatif

Position dans la page

Le numéro de page

2



	PAGES
AGRAFES MICHEL	
MAGASINS	1
PINCES A AFFRONTER	1
PINCES A POSER	2
PINCES A OTER	2
AIGUILLES	
PARACENTESE	4
SUTURES CHAS MOBILE	4 - 5
SUTURES PASSE FILS	10 - 11
SUTURES PASSE FILS MAXILLAIRES	12
ALENE	
REDON	12
AMNIOSCOPE	13
AMPLIGREFFE	13
AMYGDALOTOMES	15
ANNEAUX POUR ENDARTERIECTOMIE	17
ANSES AURICULAIRE	17
ANUSCOPES	17-18



AMNIOTOME VOIR PINCES GYNECO
ANGLE DROIT VOIR PASSE FILS
ANUSCOPE VOIR ECARTEUR AUTOSTATIQUE ALAN PARKS

AGRAFES MICHEL

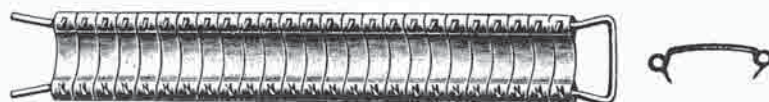

AG 001 01	7,5mm	le 100
AG 001 02	12 mm	le 100
AG 001 03	14 mm	le 100
AG 001 04	16 mm	le 100
AG 001 05	18 mm	le 100
AG 001 06	20 mm	le 100

MAGASINS



AG 001 07	7,5mm
AG 001 08	12 mm
AG 001 09	14 mm
AG 001 10	16 mm
AG 001 11	18 mm
AG 001 12	20 mm

PINCES A AFFRONTER



MICHEL - 140 mm

AG 001 13	magasin	7,5
AG 001 14	magasin	12
AG 001 15	magasin	14
AG 001 16	magasin	16
AG 001 17	magasin	18
AG 001 18	magasin	20

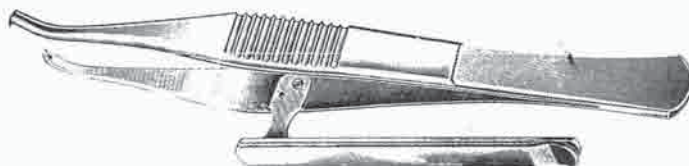

PAUCHET

mors courbes - 160 mm

AG 001 25	magasin	7,5
AG 001 26	magasin	12
AG 001 27	magasin	14
AG 001 28	magasin	16
AG 001 29	magasin	18
AG 001 30	magasin	20



AGRAFES MICHEL

PINCES A POSER

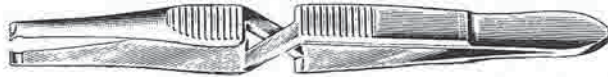

BRUNON - HEGENBART
AG 002 01 120 mm



MICHEL
AG 002 02 130 mm
AG 002 03 160 mm

PINCES A OTER

HEATH
AG 002 04 130 mm

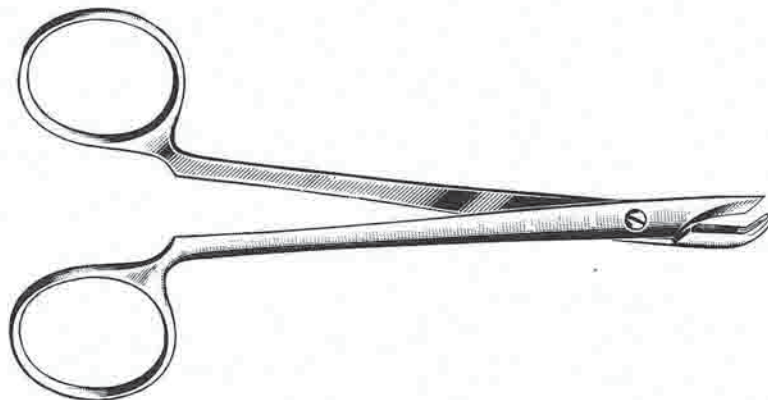
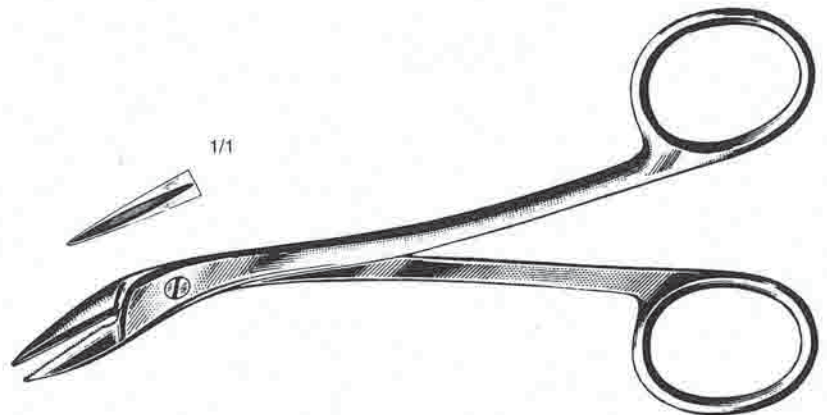

MICHEL
AG 002 05 130 mm

MICHEL - double usage
AG 002 06 120 mm

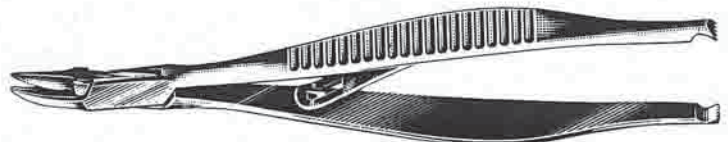



AIGUILLES

PARACENTESE



POLITZER - 80 mm

- AI 004 01 adulte
- AI 004 02 adolescent
- AI 004 03 enfant

Manche seul

- AI 004 04 80 mm

Sur manche - 160 mm

- AI 004 05 droite
- AI 004 06 coudée



SUTURES - CHAS MOBILE



REVERDIN - intestinale - 150 mm

- AI 004 15 droite



- AI 004 16 1/2 courbe



- AI 004 17 courbe



SUTURES - CHAS MOBILE

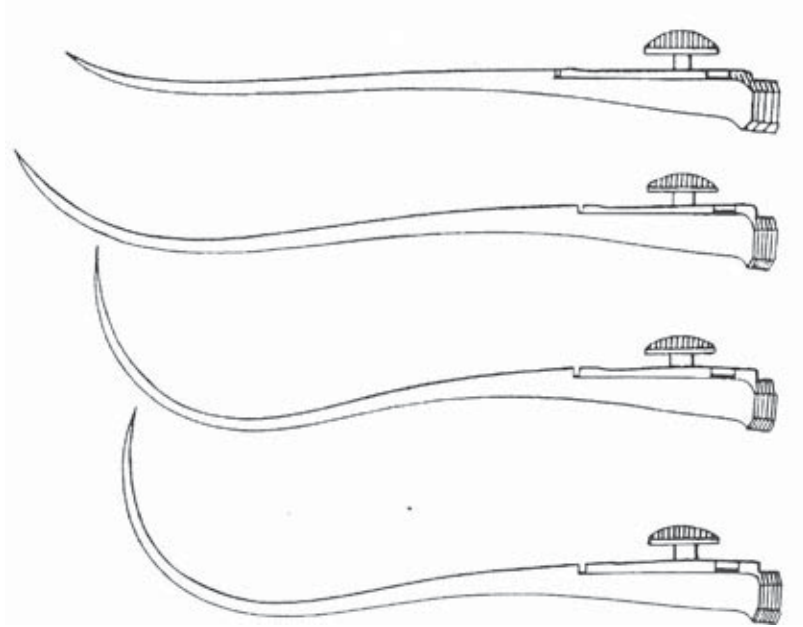

AIGUILLES

REVERDIN - moyenne - 190 mm

- AI 005 11 droite
- AI 005 12 1/2 courbe
- AI 005 13 courbe
- AI 005 14 très courbe

REVERDIN - à paroi - 220 mm

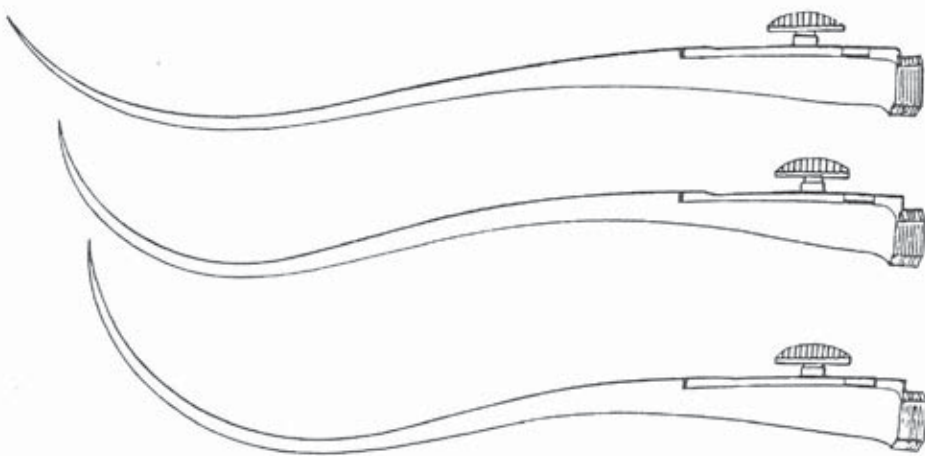

- AI 005 15 1/2 courbe
- AI 005 16 courbe
- AI 005 17 très courbe



AIGUILLES

SUTURES - PASSE FILS



BRUNNER - 300 mm

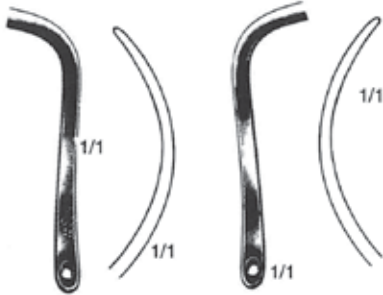

AI 010 24 coudée à droite
AI 010 25 coudée a gauche

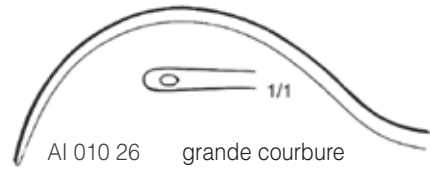

AI 010 26 grande courbure

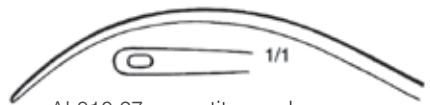

AI 010 27 petite courbure

DESCHAMPS SHAUTA - 280 mm - Pour hystérectomie voie basse



AI 010 28 coudée à droite
AI 010 29 coudée a gauche



SUTURES - PASSE FILS



DEMEL - 280 mm

- AI 011 01 grand
- AI 011 02 moyen
- AI 011 03 petit



1/1

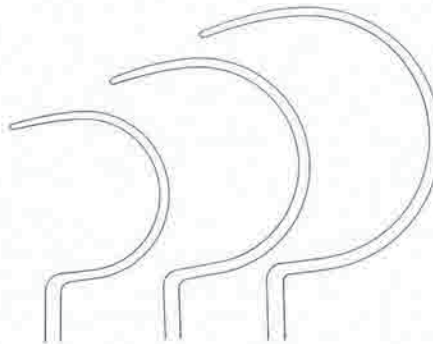

DESCHAMPS

- AI 011 04 200 mm coudée droite
- AI 011 05 200 mm coudée gauche



- AI 011 06 230 mm coudée droite
- AI 011 07 230 mm coudée gauche

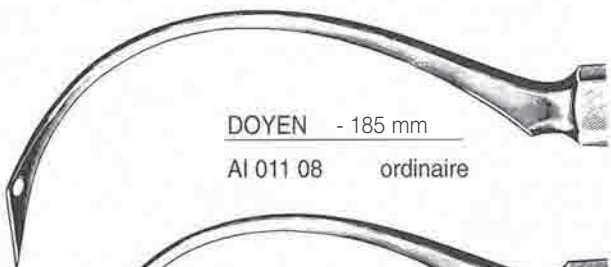

DOYEN - 185 mm

- AI 011 08 ordinaire



- AI 011 09 délicate

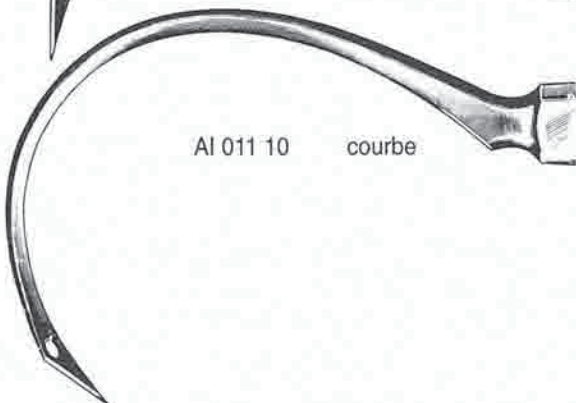

- AI 011 10 courbe

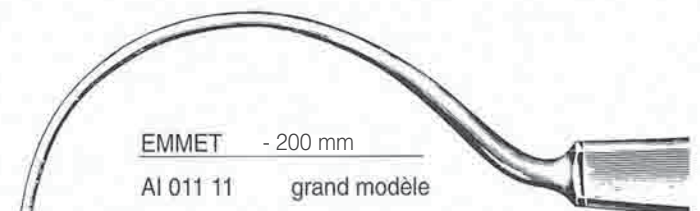

EMMET - 200 mm

- AI 011 11 grand modèle

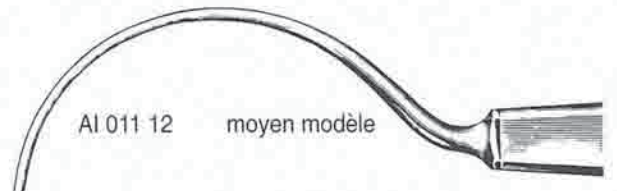

- AI 011 12 moyen modèle

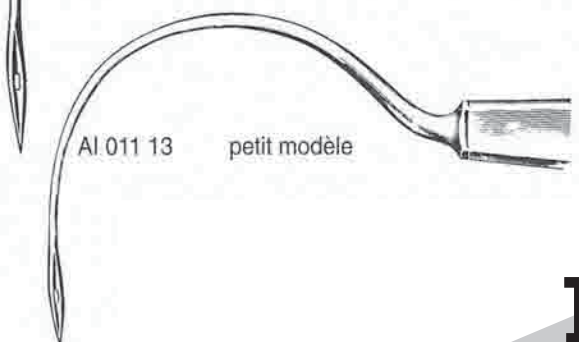

- AI 011 13 petit modèle



AIGUILLES

SUTURES - PASSE FILS - MAXILLAIRES

OBWEGESER

AI 012 05 140 mm



AI 012 06 180 mm



AI 012 07 230 mm



SANDERS BROWN

AI 012 08 290 mm



AI 012 09 300 mm



ALENE

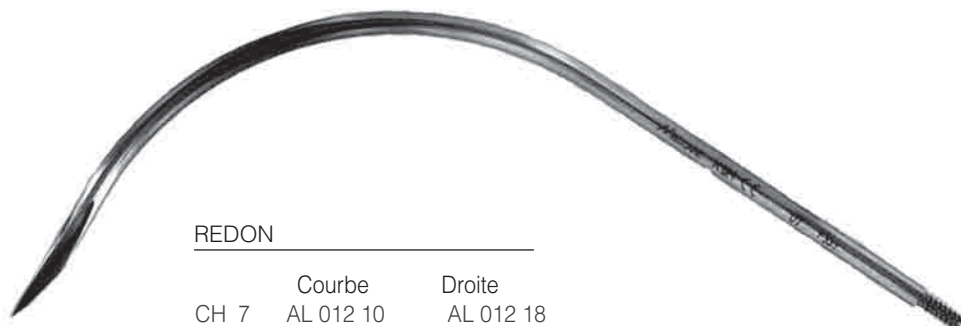

REDON

	Courbe	Droite
CH 7	AL 012 10	AL 012 18
CH 8	AL 012 11	AL 012 19
CH 9	AL 012 12	AL 012 20
CH 10	AL 012 13	AL 012 21
CH 12	AL 012 14	AL 012 22
CH 14	AL 012 15	AL 012 23
CH 15	AL 012 16	AL 012 24
CH 16	AL 012 17	AL 012 25



AMNIOSCOPE avec mandrin 200 mm

- AM 013 01 Ø 12 mm
- AM 013 02 Ø 16 mm
- AM 013 03 Ø 20 mm



AMPLIGREFFE

AMPLIGREFFE

- AM 013 04 multiplie le greffon par 2
- AM 013 05 multiplie le greffon par 4
- AM 013 06 multiplie le greffon par 6

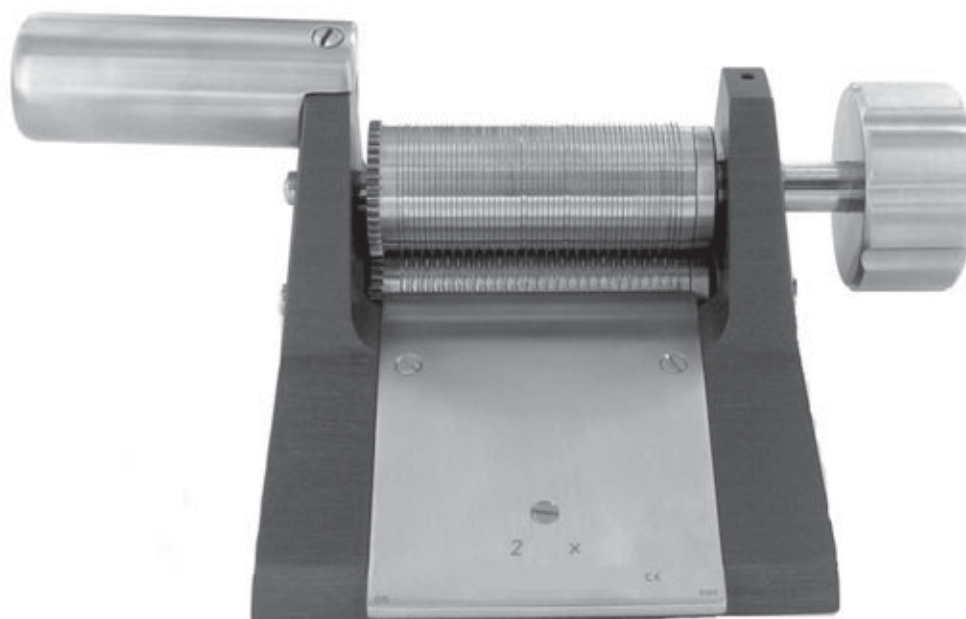



AMYGDALOTOMES

SLUDER BALLENGER

AM 015 01 complet avec 3 lames

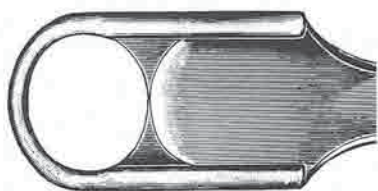
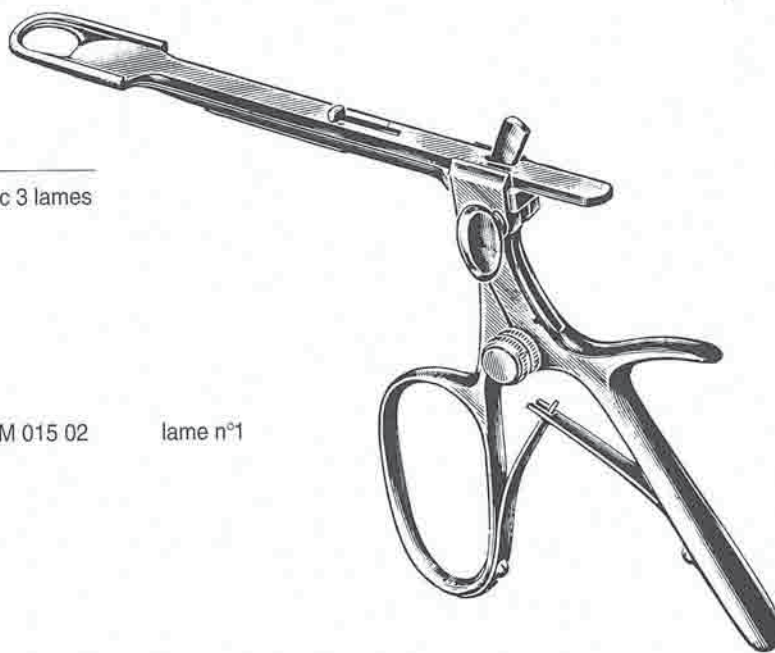

AM 015 02 lame n°1

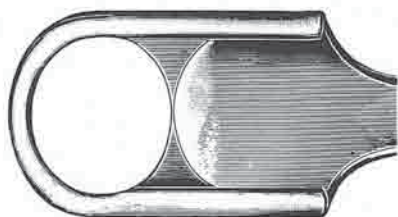

AM 015 03 lame n°2

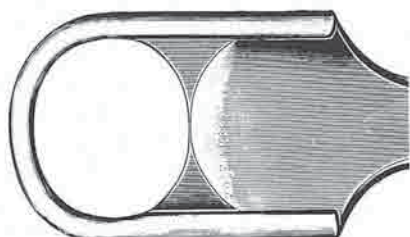

AM 015 04 lame n°3

AM 015 05 manche seul



ANNEAUX POUR ENDARTERIECTOMIE

VOLLMAR - 550 mm

AN 017 01	∅	4 mm
AN 017 02	∅	6 mm
AN 017 03	∅	7 mm
AN 017 04	∅	8 mm
AN 017 05	∅	10 mm
AN 017 06	∅	12 mm
AN 017 07	∅	14 mm

AN 017 08 manche

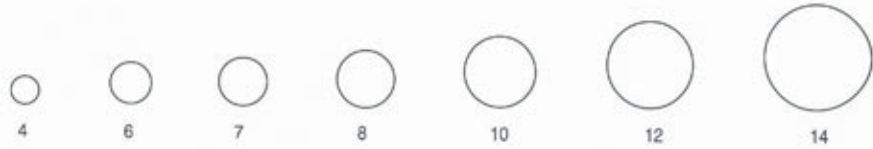

ANSES AURICULAIRES

BILLAU - 160 mm

AN 017 10 3 mm

AN 017 11 4 mm

AN 017 12 4,5 mm

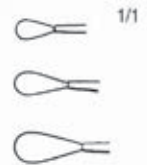

SNELLEN

AN 017 09 130 mm



ANUSCOPES



BENSAUDE

AN 017 13 adulte
 AN 017 14 enfant



ANUSCOPES

FANSLER - 95 mm

AN 018 01 Ø 22 mm



SIMS AJOURE

AN 018 02 longueur 150 mm





B

	PAGES
BISTOURIS	20
BOUGIES - DILATATEURS	22
BROSSE A ONGLES	24



BABINETTE
BAGUES
BULLDOG
BURINS

VOIR
VOIR
VOIR
VOIR

PINCES FILS D'ACIER
PINCES COUPANTES
CLAMPS
CISEAUX A OS



BISTOURIS

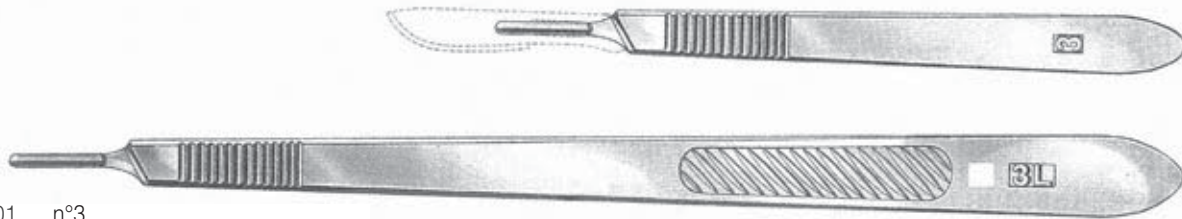

- BI 020 01 n°3
- BI 020 02 n°3 L
- BI 020 09 n°3 L angulé sur le plat

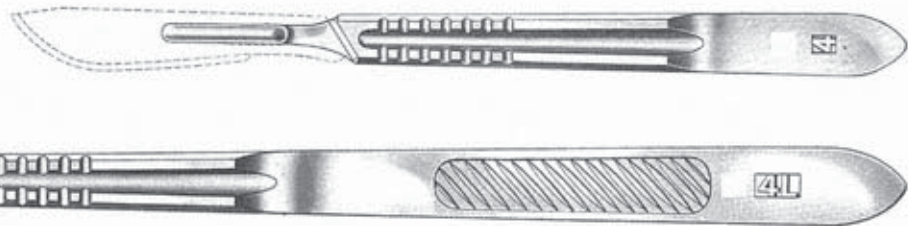

- BI 020 03 n°4
- BI 020 04 n°4 L
- BI 020 10 n°4 L angulé sur le plat
- BI 020 11 n°4 L courbe sur le champ

SIMS - 220 mm



- BI 020 05 coudé à droite
- BI 020 06 coudé à gauche
- BI 020 07 droit



BRISE-LAMES

- BI 020 08 120 mm

**BOUGIES - DILATATEURS**HEGAR - simple inox

BO 021 01	1 mm	BO 021 61	12.5 mm
BO 021 50	1.5 mm	BO 021 13	13 mm
BO 021 02	2 mm	BO 021 62	13.5 mm
BO 021 51	2.5 mm	BO 021 14	14 mm
BO 021 03	3 mm	BO 021 63	14.5 mm
BO 021 52	3.5 mm	BO 021 15	15 mm
BO 021 04	4 mm	BO 021 64	15.5 mm
BO 021 53	4.5 mm	BO 021 16	16 mm
BO 021 05	5 mm	BO 021 65	16.5 mm
BO 021 54	5.5 mm	BO 021 17	17 mm
BO 021 06	6 mm	BO 021 18	18 mm
BO 021 55	6.5 mm	BO 021 19	19 mm
BO 021 07	7 mm	BO 021 20	20 mm
BO 021 56	7.5 mm	BO 021 21	21 mm
BO 021 08	8 mm	BO 021 22	22 mm
BO 021 57	8.5 mm	BO 021 23	23 mm
BO 021 09	9 mm	BO 021 24	24 mm
BO 021 58	9.5 mm	BO 021 25	25 mm
BO 021 10	10 mm	BO 021 26	26 mm
BO 021 59	10.5 mm	BO 021 27	27 mm
BO 021 11	11 mm	BO 021 28	28 mm
BO 021 60	11.5 mm	BO 021 29	29 mm
BO 021 12	12 mm	BO 021 30	30 mm

HEGAR - double inox

BO 021 31	1 x 2 mm
BO 021 32	3 x 4 mm
BO 021 33	5 x 6 mm
BO 021 34	7 x 8 mm
BO 021 35	9 x 10 mm
BO 021 36	11 x 12 mm
BO 021 37	13 x 14 mm
BO 021 38	15 x 16 mm
BO 021 39	17 x 18 mm
BO 021 40	19 x 20 mm
BO 021 41	21 x 22 mm
BO 021 42	23 x 24 mm
BO 021 43	25 x 26 mm

BOITES COMPLETES

LES BOITES NE SONT PAS AUTOCLAVABLES.

SEULS LES BOUGIES ET LES CHEVALETS SONT AUTOCLAVABLES SOUS DOUBLE EMBALLAGE.

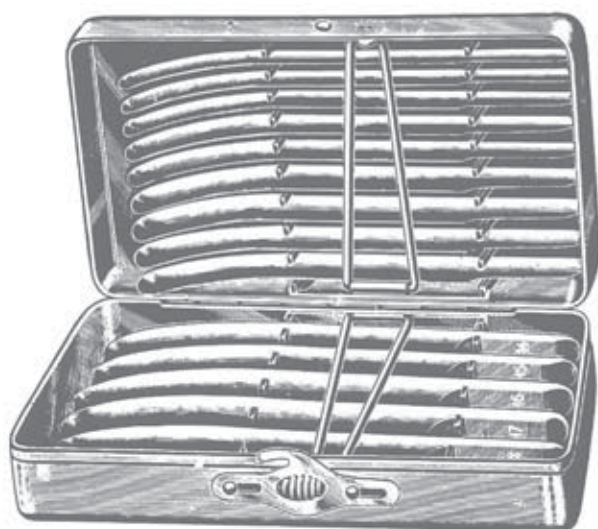
Pour bougies simples

BO 021 46 série n°1 à 26
BO 021 47 série n°4 à 17

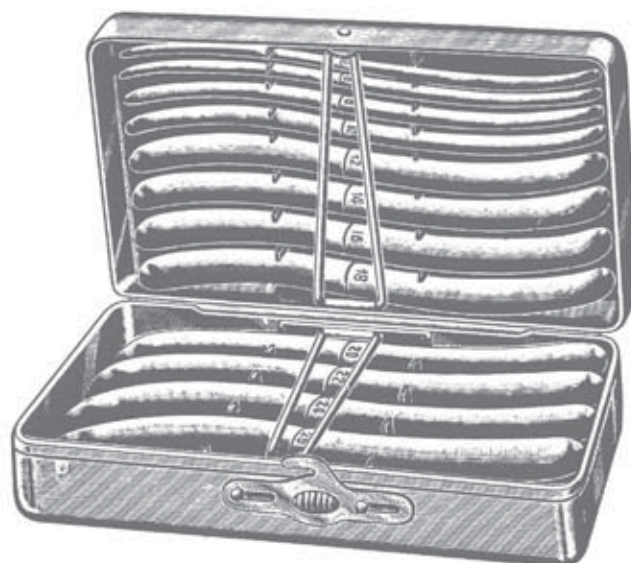
Pour bougies doubles

BO 021 48 série n° 1 x 2 à 25 x 26
BO 021 49 série n° 3 x 4 à 17 x 18



BROSSES A ONGLES

DISTRIBUTEUR

- BR 024 01 20 brosses
- BR 024 03 10 brosses
- BR 024 04 Verre de rechange

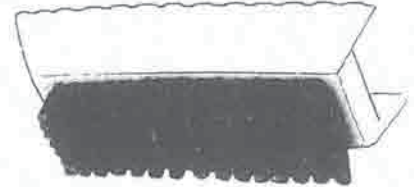

BROSSE STERILISABLE

BR 024 02



C

CADRE PORTE INSTRUMENTS	PAGES		PAGES
CANULES	26	CLAMPS VASCULAIRES	98 - 121
ASPIRATION	26 - 27	ANASTOMOSES	98
BIOPSIE ENDO UTERINE	28	AORTIQUES	99 - 101
HEPARINE	28	AORTIQUES - ANEURISMES	102
HYSTEROGRAPHIE	28	AURICULAIRES	103
RADIOMANOMETRIE	28	BRONCHES	103 - 104
CHASSE GREFFONS	29	BULLDOG	104 - 105
CHAUSSE VEINE	29	CAROTIDES	105 - 106
CISAILLES		COARCTATION	106 - 110
PLATRE	30	ILIAQUES	111
PANSEMENTS ET VETEMENTS	30	LIGATURES - DISSECTIONS	111 - 112
CISEAUX		MULTIPOSE	112 - 114
COURANTS	32 - 37	OCCLUSION TANGENTIELLE	114
DISSECTEURS	39 - 42	PERIPHERIQUES	115 - 118
FILS ACIER - LIGATURES	42 - 43	PEDIATRIQUES	118 - 121
GYNECOLOGIE	46 - 47	RENALES - VEINE CAVE	121
MICRO	49 - 50	CLIPS	
ORL - PLASTIE	52 - 55	ANEURISMES	124 - 125
ONGLES	57	VAISSEAUX	126
PANSEMENTS - PLATRE	59 - 61	VEINE CAVE	127
VASCULAIRES	63 - 65	COSTOTOMES	130 - 132
CISEAUX A OS		COUTEAUX	
BURINS	67 - 71	MENISQUES	134
GOUGES	73 - 77	ORL	136 - 137
OSTEOTOMES	80 - 82	CROCHETS	139 - 144
CLAMPS BULLDOG	86 - 89	CURETTES	
CLAMPS DIGESTIFS	91 - 96	CALCULS - BILIAIRES	146 - 147
		CALCULS - RENAUX	147
		DERMATO	148
		GYNECO	148 - 150
		ORL	152 - 154
		OSSEUSES	156 - 158



CADRES A LAPAROTOMIE	VOIR	ECARTEURS ABDOMINAUX
CISEAUX MEDECIN	VOIR	CISEAUX COURANTS
CONDUCTEUR POUR SCIE EN FIL	VOIR	SCIES
COUPE BAGUES	VOIR	PINCES COUPANTES



CADRE PORTE INSTRUMENTS

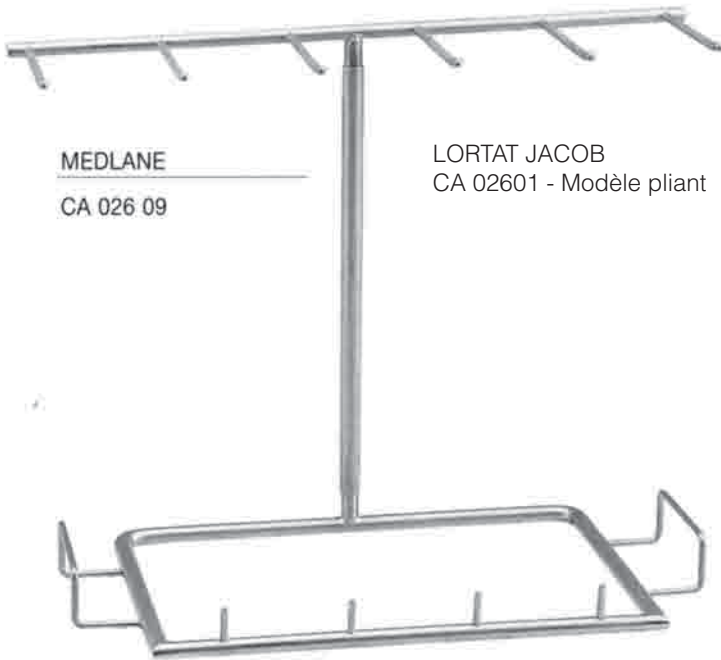

MEDLANE
CA 026 09

LORTAT JACOB
CA 02601 - Modèle pliant

Epingle - porte-pinces
CA 026 02 150 mm

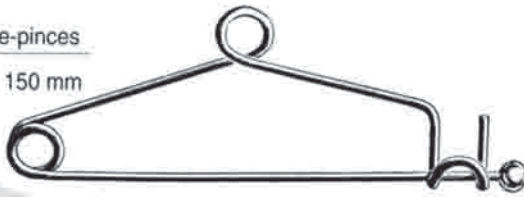

CANULES ASPIRATION

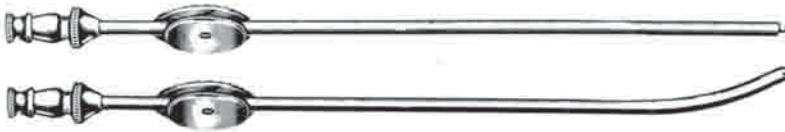

ADSON - 210 mm - Ø 4 mm

CA 026 03 droite

CA 026 04 courbe



AUBERT - 355 mm - Ø 10 mm

CA 026 05 embout 15 mm



FRAZIER - droite - 125 mm

CA 026 06 Ø 2,6 mm

CA 026 07 Ø 3,3 mm

CA 026 08 Ø 4 mm



CANULES ASPIRATION



FRAZIER - coudée - 125 mm

CA 027 01	Ø 2,6 mm
CA 027 02	Ø 3,3 mm
CA 027 03	Ø 4 mm

FRAZIER - coudée - 180 mm

CA 027 04	Ø 2,6 mm
CA 027 05	Ø 3,3 mm
CA 027 06	Ø 4 mm



POOLE

CA 027 07	205 mm	Ø 5 mm
CA 027 08	220 mm	Ø 10 mm



CA 027 09	220 mm	Ø 8 mm
-----------	--------	--------



SANTY - 280 mm

CA 027 10	Ø 2,5 mm	embout Ø 4 mm
CA 027 11	Ø 4 mm	embout Ø 7 mm
CA 027 12	Ø 5 mm	embout Ø 9 mm
CA 027 13	Ø 8 mm	embout Ø 13 mm

WERTHEIMER malléable - 250 mm

CA 027 14	Ø 1 mm
CA 027 15	Ø 2 mm
CA 027 16	Ø 3 mm
CA 027 17	Ø 4 mm
CA 027 18	Ø 5 mm
CA 027 19	Ø 6 mm
CA 027 20	Ø 7 mm



WERTHEIMER rigide coudée - 170 mm

CA 027 21	Ø 1 mm
CA 027 22	Ø 2 mm
CA 027 23	Ø 3 mm
CA 027 24	Ø 4 mm
CA 027 25	Ø 5 mm
CA 027 26	Ø 6 mm
CA 027 27	Ø 7 mm



YANKAUER - 260 mm

CA 027 28	Ø 9 mm
-----------	--------





CANULES - BIOPSIE ENDO - UTERINE

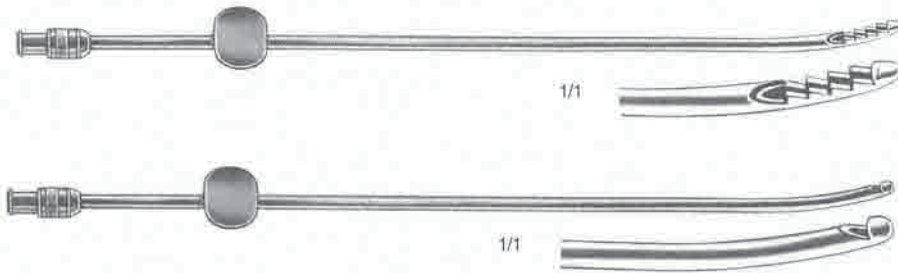

NOVACK - 230 mm		
CA 028 01	Ø 2 mm	
CA 028 02	Ø 3 mm	
CA 028 03	Ø 4 mm	

RANDALL - 240 mm		
CA 028 04	Ø 4 mm	

CANULES - HEPARINE

CA 028 05	Ø 2,5 mm	embout Ø 4 mm	Fig 1
CA 028 06	Ø 2,5 mm	embout Ø 4 mm	Fig 2
CA 028 07	Ø 2,5 mm	embout Ø 4 mm	Fig 3

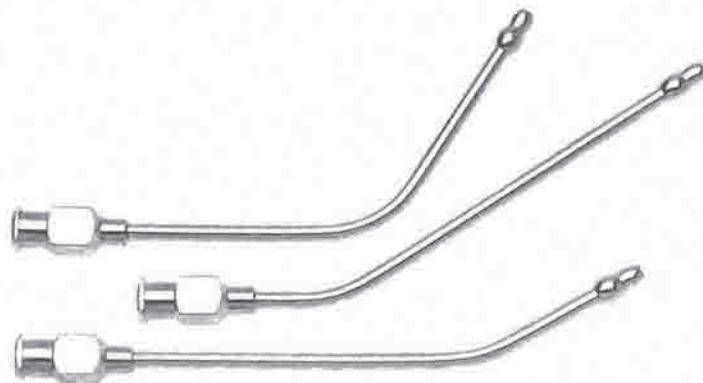

Modèle fin (non illustré)

CA 028 08	Ø 1,5 mm	embout Ø 2 mm
-----------	----------	---------------

CANULES - HYSTEROGRAPHIE

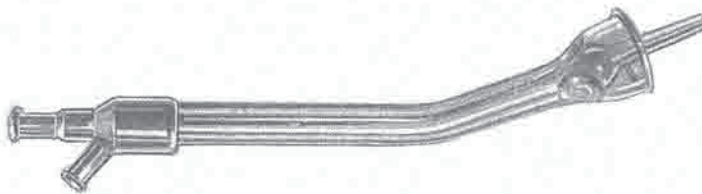

BOMMELAER - bec court

CA 028 09	Ø 20 mm
CA 028 10	Ø 25 mm
CA 028 11	Ø 30 mm

BOMMELAER - bec long

CA 028 12	Ø 20 mm
CA 028 13	Ø 25 mm
CA 028 14	Ø 30 mm

CANULES - RADIOMANOMETRIE

CHAMPEAU

CA 028 15	Ø 13/10	droite
CA 028 16	Ø 18/10	droite



CA 028 17	Ø 13/10	courbe
CA 028 18	Ø 18/10	courbe



LIEBOVICI

CA 028 19	Ø 13/10	courbe
CA 028 20	Ø 18/10	courbe





CHASSE GREFFONS

CYLINDRIQUE - 160 mm

- CH 029 01 Ø 3 mm
- CH 029 02 Ø 4 mm
- CH 029 03 Ø 5 mm
- CH 029 11 Ø 6 mm
- CH 029 12 Ø 8 mm
- CH 029 04 Ø 10 mm



CYLINDRIQUE DOUBLE

- CH 029 05 Ø 8 x 15 mm 160 mm
- CH 029 06 Ø 6 x 8 mm 210 mm
- CH 029 07 Ø 10 x 12 mm 210 mm



TRILLAT - 200 mm

- CH 029 08 embout 9 x 9 mm
- CH 029 09 embout 9 x 19 mm

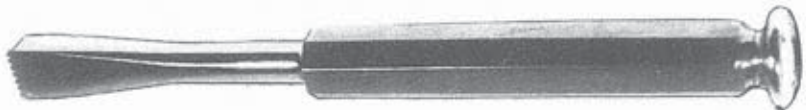

CHAUSSE VEINE

KIENNY

- CH 029 10 175 mm





CISAILLES A PLATRES



SEUTIN - 230 mm
 CI 030 01 droite
 CI 030 02 en S

STILLE

CI 030 03	230 mm
CI 030 04	260 mm
CI 030 05	370 mm

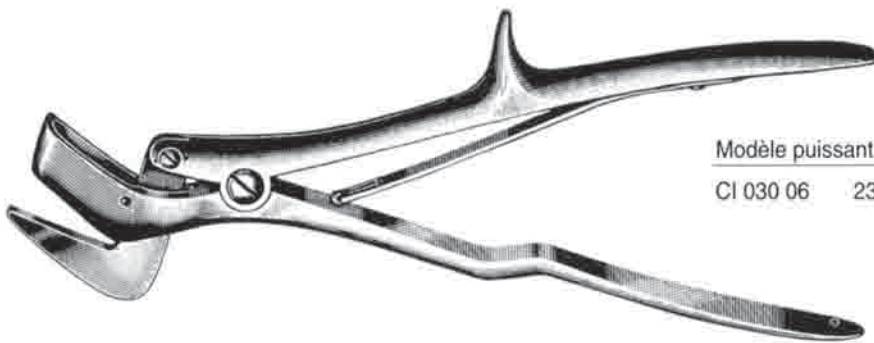

Modèle puissant
 CI 030 06 230 mm

CISAILLE PANSEMENTS ET VETEMENTS

CI 030 07 200 mm





CISEAUX COURANTS

MOUSSE - MOUSSE (MEDECIN)

	droit	courbe
100 mm	CI 032 01	CI 032 02
120 mm	CI 032 03	CI 032 04
145 mm	CI 032 05	CI 032 06
160 mm	CI 032 07	CI 032 08
180 mm	CI 032 09	CI 032 10

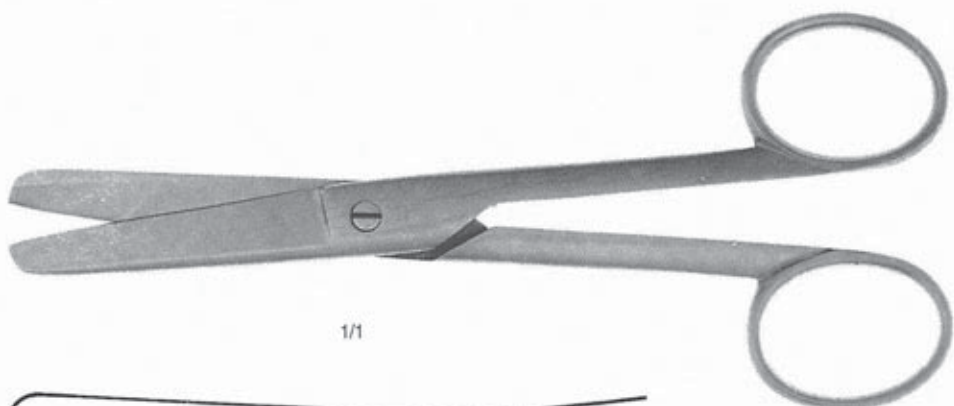

1/1

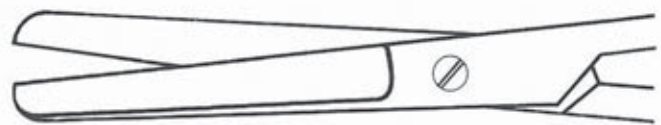

MOUSSE - POINTU (DAUPHIN)

	droit	courbe
120 mm	CI 032 11	CI 032 12
145 mm	CI 032 13	CI 032 14
160 mm	CI 032 15	CI 032 16
180 mm	CI 032 17	CI 032 18



1/1

POINTU - POINTU

	droit	courbe
100 mm	CI 032 19	CI 032 20
120 mm	CI 032 21	CI 032 22
145 mm	CI 032 23	CI 032 24
160 mm	CI 032 25	CI 032 26
180 mm	CI 032 27	CI 032 28

1/1



DEMONTABLE (A DOIGT)

Mousse - Mousse

	droit	courbe
140 mm	CI 032 29	CI 032 30



1/1



CISEAUX COURANTS

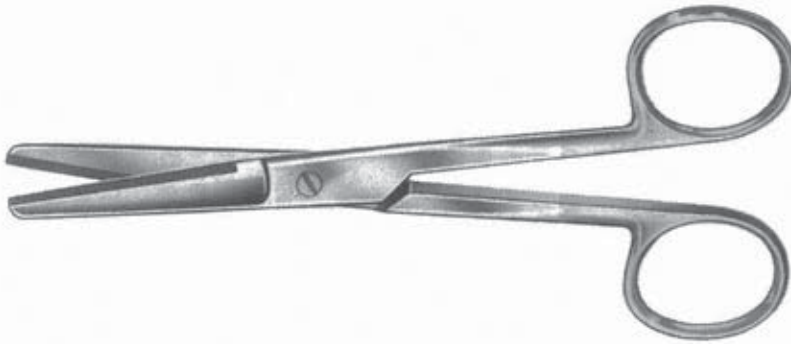

TUNGSTENE - 145 mm
Mousse - Mousse

CI 033 01	droit
CI 033 02	courbe

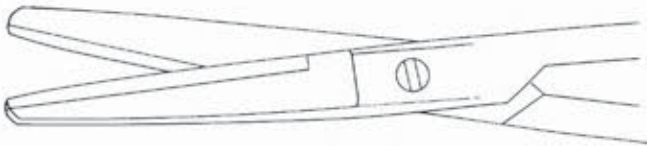

Mousse - Pointu

CI 033 03	droit
CI 033 04	courbe

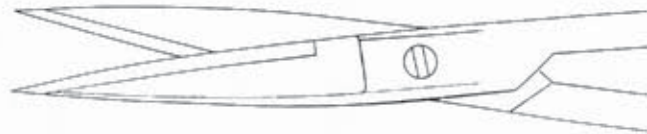
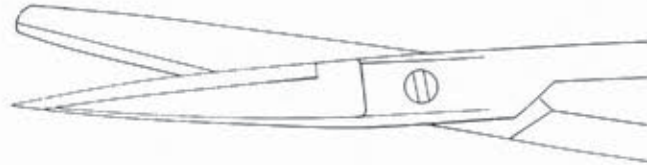

Pointu - Pointu

CI 033 05	droit
CI 033 06	courbe

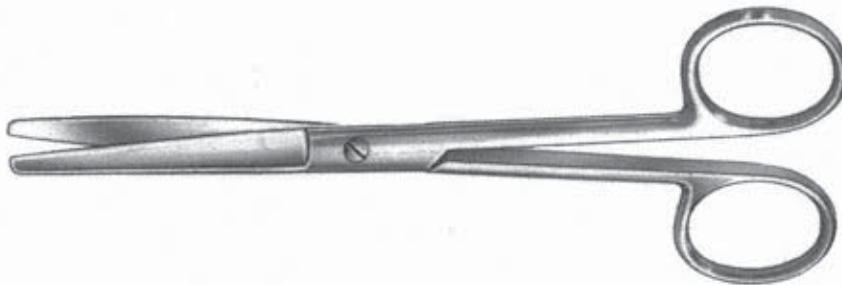

COOPER
Mousse - Mousse

	droit	courbe
130 mm	CI 033 07	CI 033 08
145 mm	CI 033 09	CI 033 10



1/1

Mousse - Pointu

	droit	courbe
130 mm	CI 033 11	CI 033 12
145 mm	CI 033 13	CI 033 14



1/1

Pointu - Pointu

	droit	courbe
130 mm	CI 033 15	CI 033 16
145 mm	CI 033 17	CI 033 18



1/1



CISEAUX COURANTS

ENUCLEATION - 130 mm

- | | |
|-----------|--------|
| CI 034 01 | droit |
| CI 034 02 | courbe |

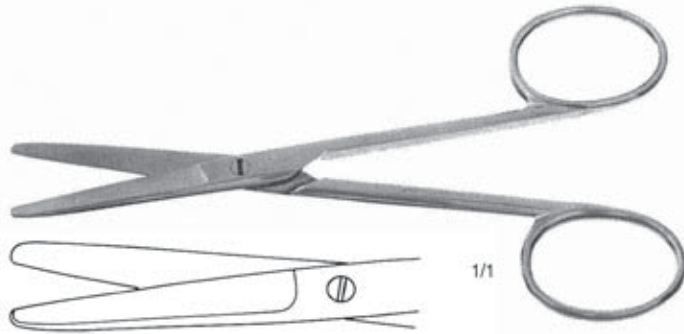

IRIDECTOMIE - 105 mm

- | | |
|-----------|--------|
| CI 034 03 | droit |
| CI 034 04 | courbe |

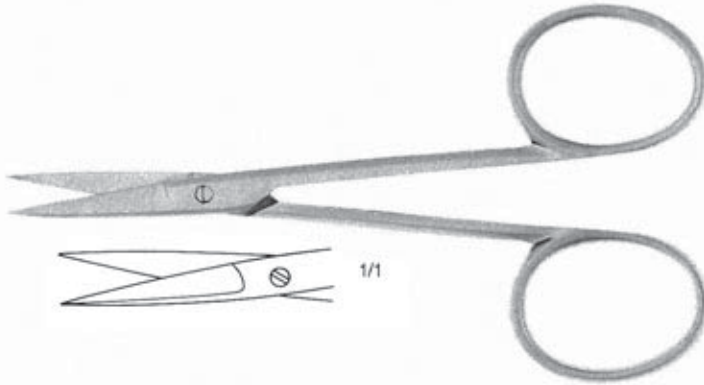

IRIDECTOMIE TUNGSTENE - 115 mm

- | | |
|-----------|--------|
| CI 034 07 | droit |
| CI 034 08 | courbe |

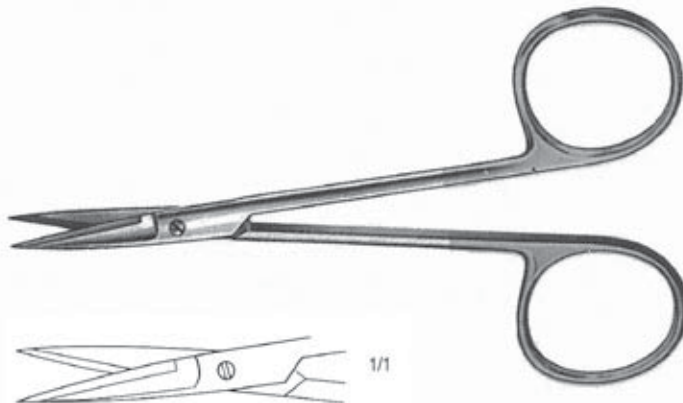



CISEAUX COURANTS

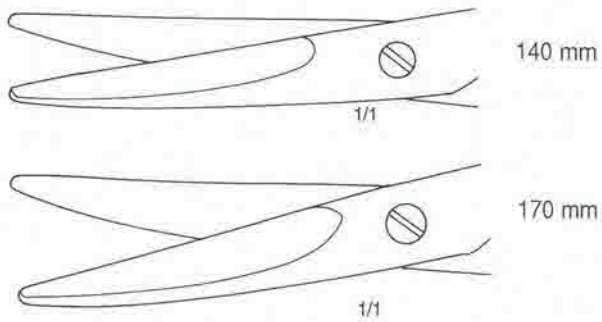
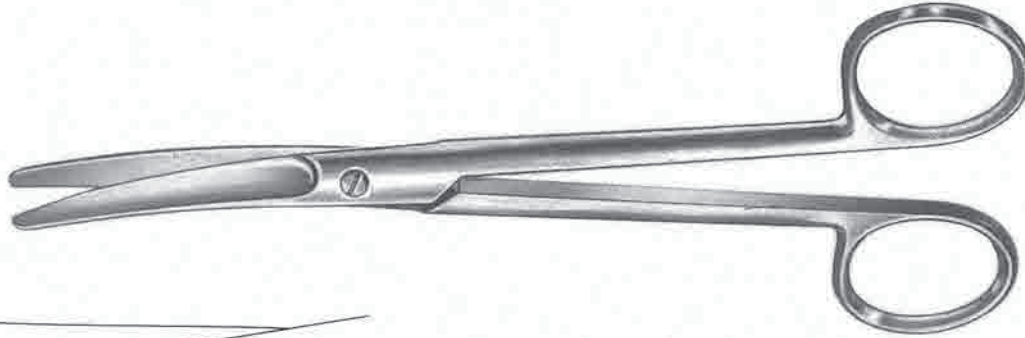

MAYO

	droit	courbe
140 mm	CI 035 01	CI 035 02
170 mm	CI 035 03	CI 035 04
200 mm	CI 035 15	CI 035 16
230 mm	CI 035 05	CI 035 06

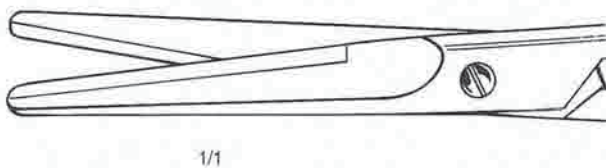
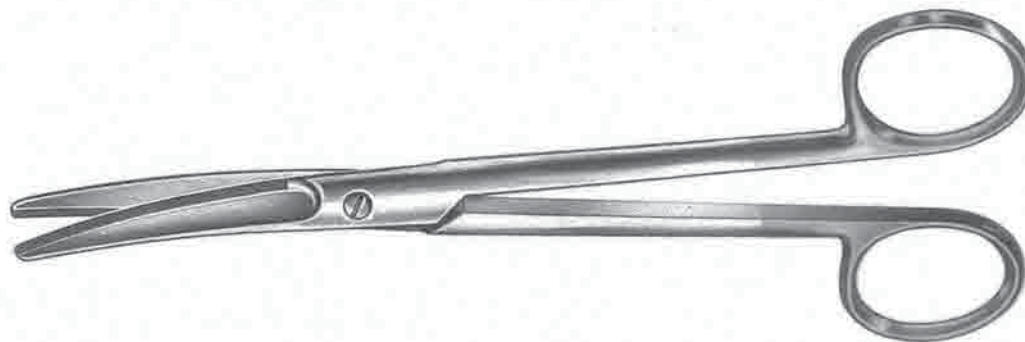

MAYO - TUNGSTENE

	droit	courbe
140 mm	CI 035 07	CI 035 08
170 mm	CI 035 09	CI 035 10
200 mm	CI 035 11	CI 035 12
230 mm	CI 035 13	CI 035 14



CISEAUX COURANTS

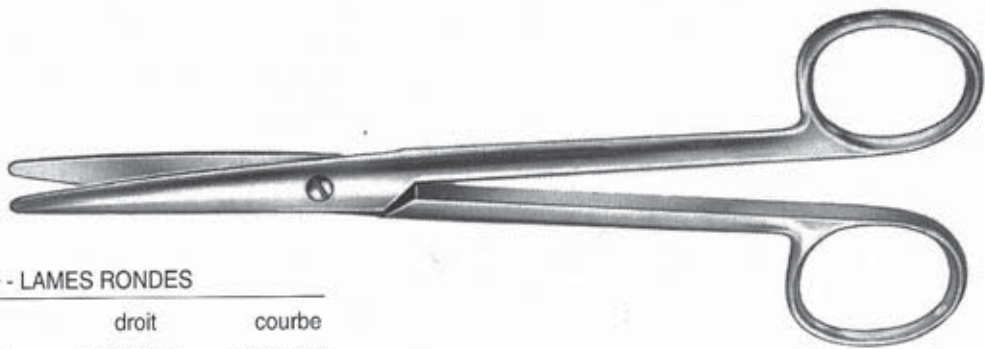

MAYO - LAMES RONDES

	droit	courbe
140 mm	CI 036 01	CI 036 02
150 mm	CI 036 03	CI 036 04
170 mm	CI 036 05	CI 036 06

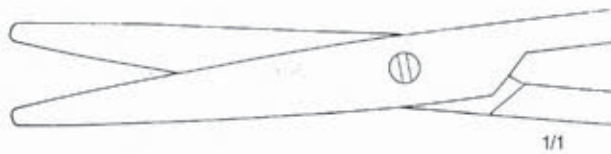
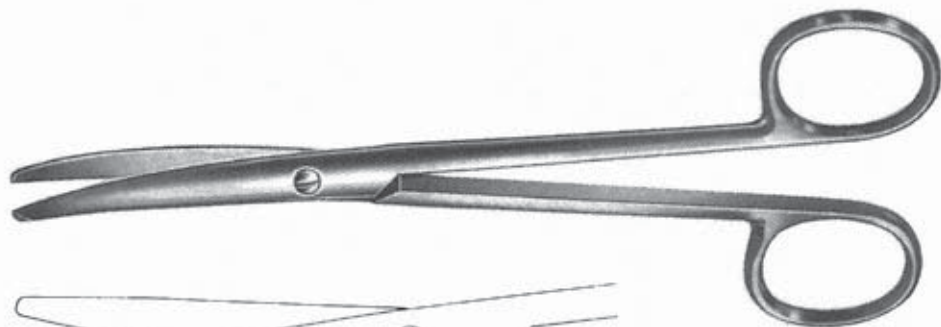

MAYO LEXER - 160 mm

CI 036 09	droit
CI 036 10	courbe

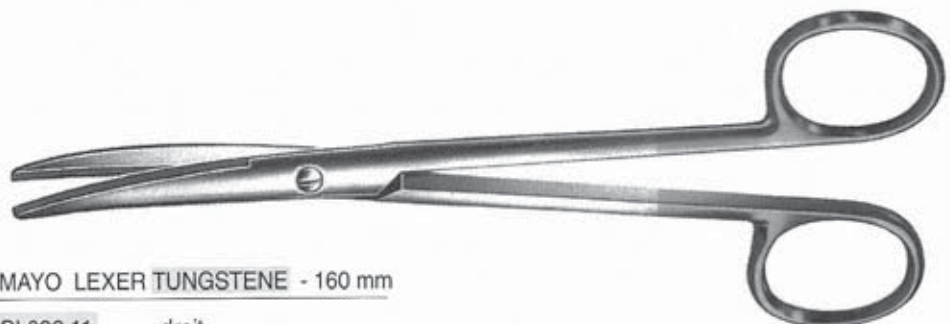

MAYO LEXER TUNGSTENE - 160 mm

CI 036 11	droit
CI 036 12	courbe



CISEAUX COURANTS

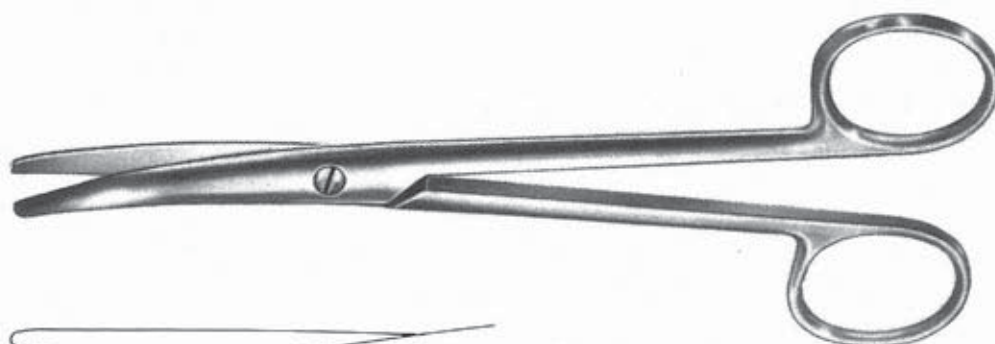

1/1

1/1

MAYO STILLE

	droit	courbe
150 mm	CI 037 01	CI 037 02
170 mm	CI 037 03	CI 037 04

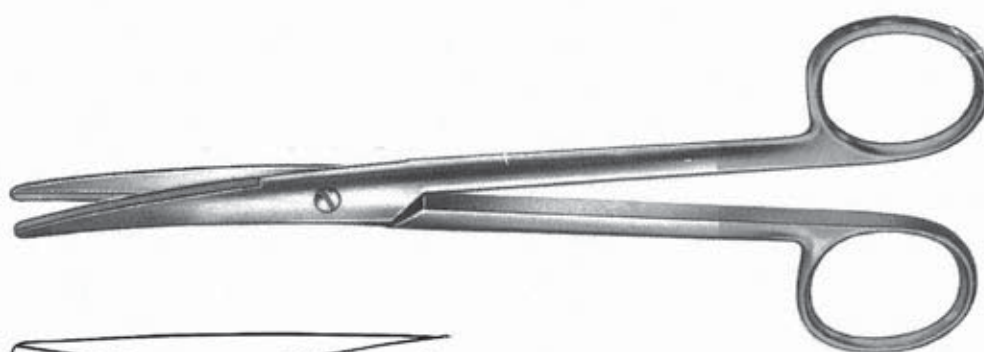

1/1

MAYO STILLE TUNGSTENE

	droit	courbe
150 mm	CI 037 05	CI 037 06
170 mm	CI 037 07	CI 037 08

STRABISME - 110 mm

CI 037 09	droit
CI 037 10	courbe

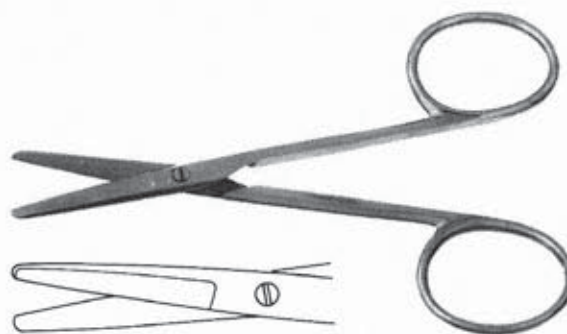

1/1



CISEAUX DISSECTEURS

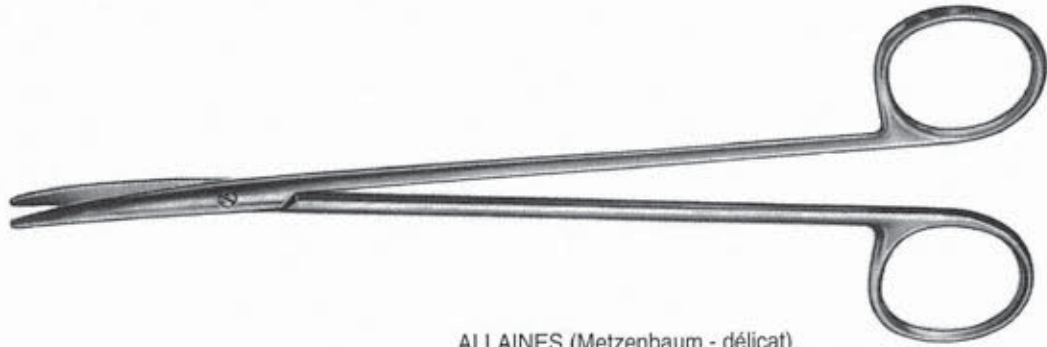

ALLAINES (Metzenbaum - délicat)

		droit	courbe
1/1	140 mm	CI 039 01	CI 039 02
1/1	180 mm	CI 039 03	CI 039 04
1/1	200 mm	CI 039 05	CI 039 06
1/1	230 mm	CI 039 07	CI 039 08
	250 mm		CI 039 09
	300 mm		CI 039 10

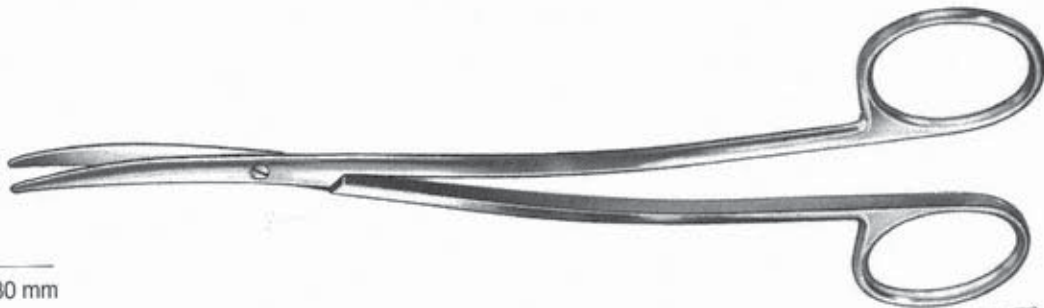

BOYD en S
CI 039 11 180 mm

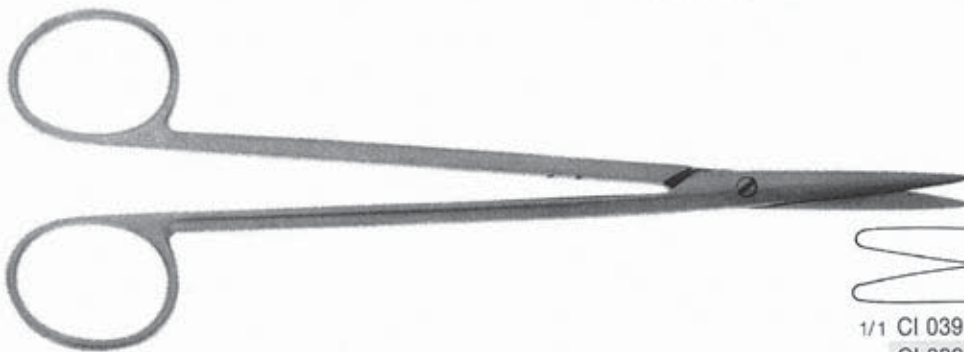

1/1

1/1 CI 039 15 230 mm
CI 039 20 230 mm **TUNGSTENE**

DE MARTEL - très délicat - courbe

1/1	CI 039 12	140 mm	TUNGSTENE
	CI 039 17	140 mm	
1/1	CI 039 13	180 mm	TUNGSTENE
	CI 039 18	180 mm	
1/1	CI 039 14	200 mm	TUNGSTENE
	CI 039 19	200 mm	

1/1

CI 039 16 190 mm coudé sur le plat



CISEAUX DISSECTEURS

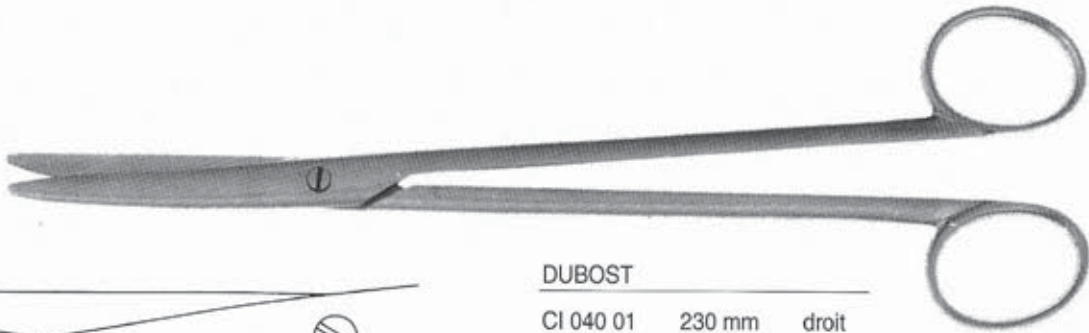

DUBOST



CI 040 01	230 mm	droit
CI 040 02	230 mm	courbe



CI 040 03	250 mm	droit
CI 040 04	250 mm	courbe



CI 040 05	300 mm	courbe
-----------	--------	--------

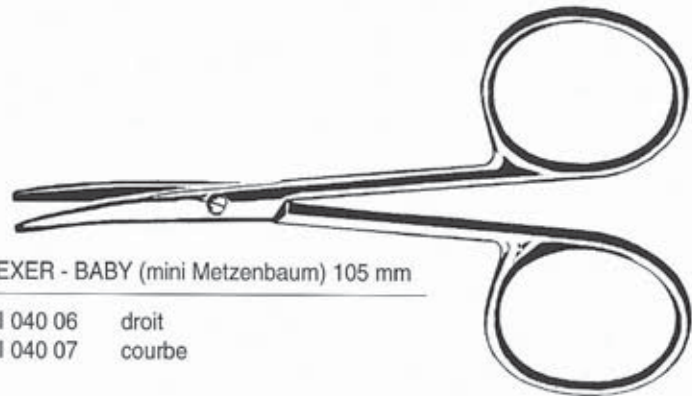

LEXER - BABY (mini Metzenbaum) 105 mm



CI 040 06	droit
CI 040 07	courbe

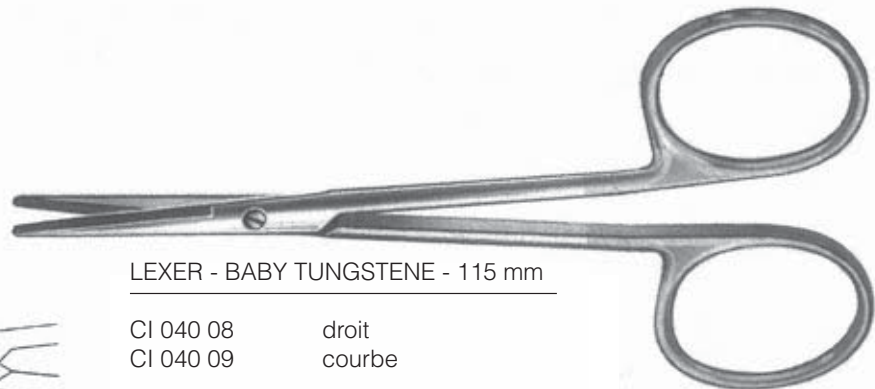

LEXER - BABY TUNGSTENE - 115 mm



CI 040 08	droit
CI 040 09	courbe



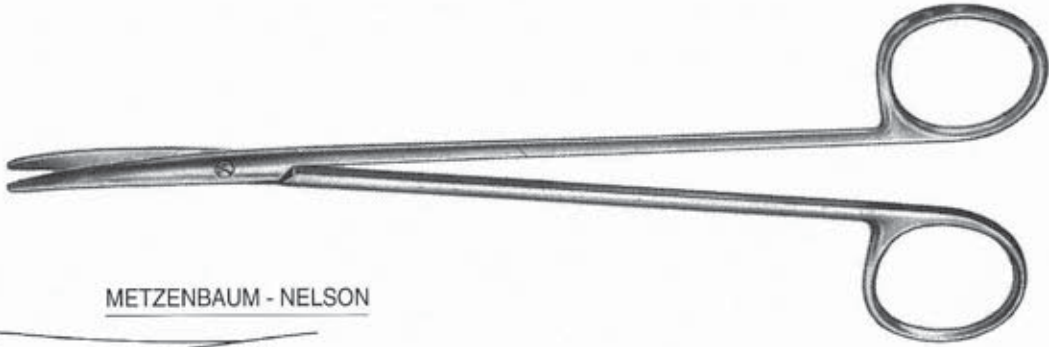

CISEAUX DISSECTEURS





METZENBAUM - NELSON

 1/1
 CI 041 01 140 mm droit
 CI 041 02 140 mm courbe

 1/1
 CI 041 03 180 mm droit
 CI 041 04 180 mm courbe

 1/1
 CI 041 05 200 mm droit
 CI 041 06 200 mm courbe

 1/1
 CI 041 07 230 mm droit
 CI 041 08 230 mm courbe

 1/1
 CI 041 09 250 mm droit
 CI 041 10 250 mm courbe
 CI 041 11 300 mm courbe (non illustré)

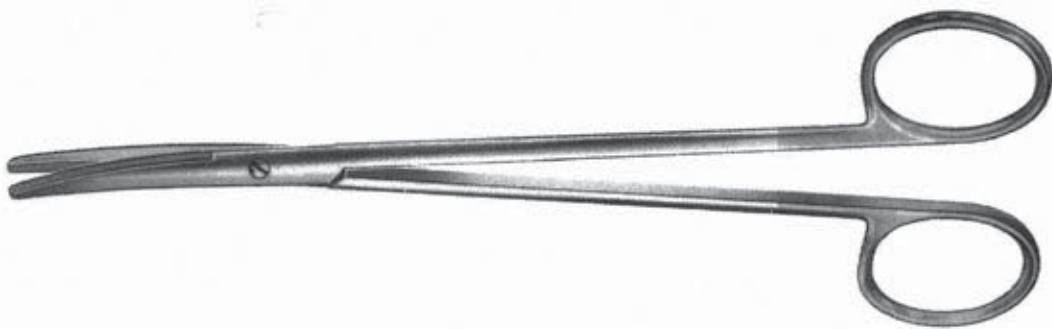

METZENBAUM - NELSON TUNGSTENE

	droit		courbe			droit		courbe	
140 mm	CI 041 12	CI 041 13			230 mm	CI 041 18	CI 041 19		
180 mm	CI 041 14	CI 041 15			260 mm	CI 041 20	CI 041 21		
200 mm	CI 041 16	CI 041 17			300 mm		CI 041 22		



CISEAUX DISSECTEURS

METZENBAUM - NELSON (délicat)

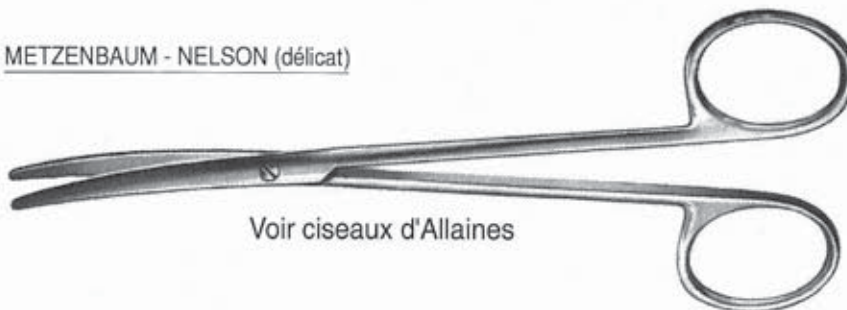

Voir ciseaux d'Allaines



METZENBAUM - NELSON (délicat)

TUNGSTENE

	droit	courbe
140 mm	CI 042 01	CI 042 02
180 mm	CI 042 03	CI 042 04
200 mm	CI 042 05	CI 042 06
230 mm	CI 042 07	CI 042 08
260 mm		CI 042 09
280 mm		CI 042 10

CISEAUX FILS ACIER - LIGATURES

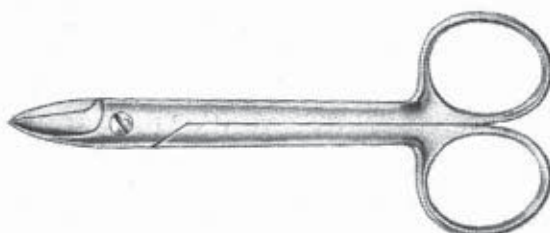

BEEBE - lame crantée pour fils acier - 110 mm

CI 042 11	droit
CI 042 12	courbe



CISEAUX FILS ACIER - LIGATURES

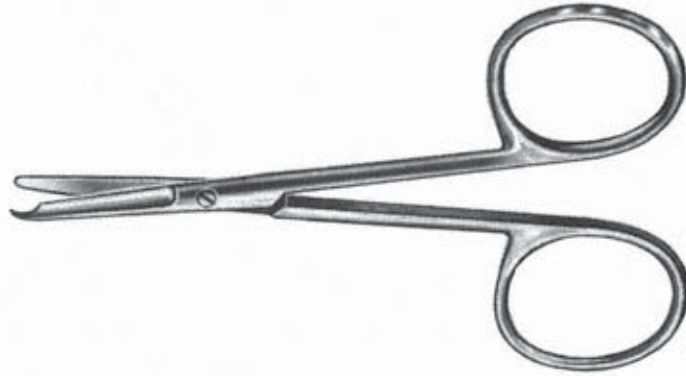

SPENCER

CI 044 01	90 mm	droit
CI 044 02	90 mm	courbe
CI 044 03	110 mm	droit
CI 044 04	110 mm	courbe
CI 044 05	130 mm	droit
CI 044 06	130 mm	courbe

UNIVERSEL - pour fils acier

CI 044 07 120 mm

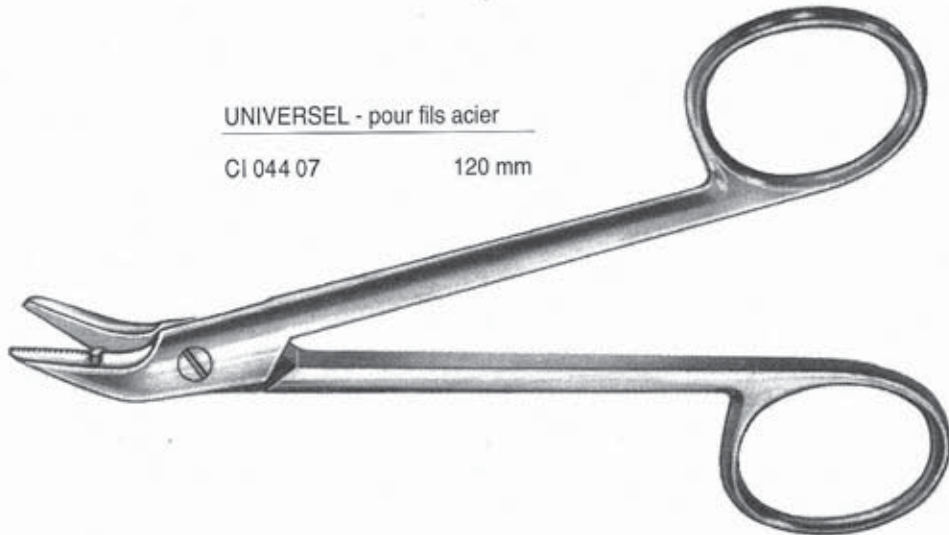

UNIVERSEL TUNGSTENE

CI 044 08 120 mm





CISEAUX GYNECOLOGIE



BRAUN STADLER - Episiotomie

CI 046 01	140 mm
CI 046 02	200 mm

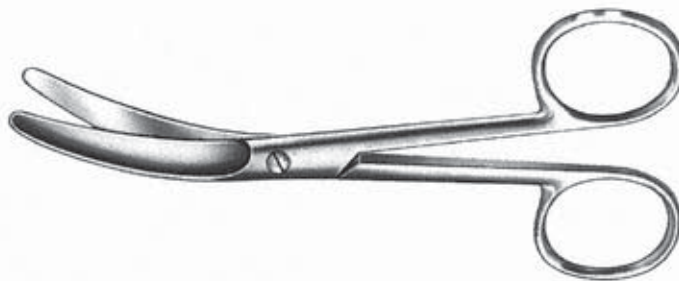

BUSCH - (Cordon Omibilical)

CI 046 03	130 mm
CI 046 04	160 mm

DELESTRE - Episiotomie

CI 046 05	140 mm
-----------	--------

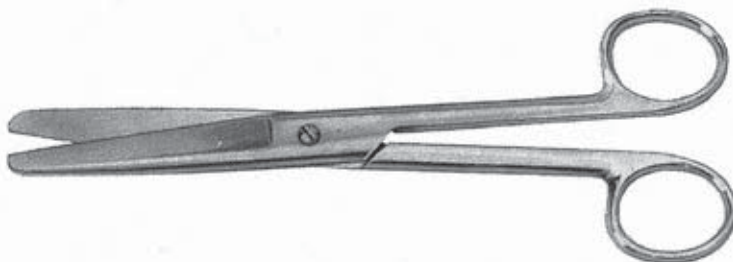

DOYEN - 180 mm

CI 046 06	droit
CI 046 07	courbe



CISEAUX GYNECOLOGIE

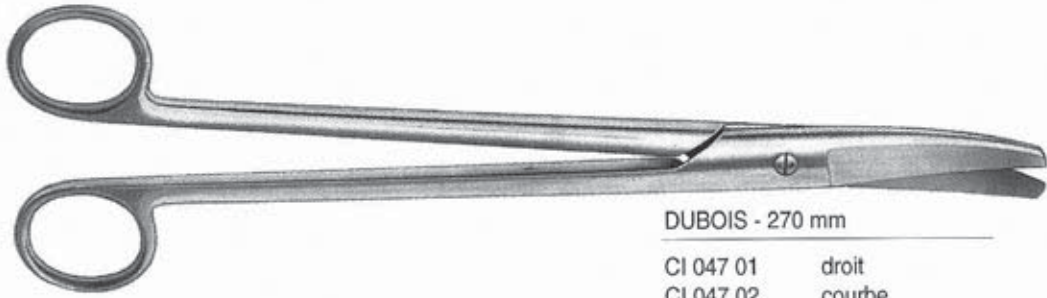

DUBOIS - 270 mm

- | | |
|-----------|--------|
| CI 047 01 | droit |
| CI 047 02 | courbe |

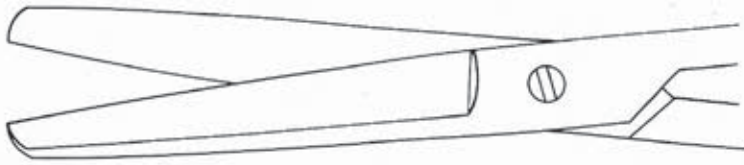
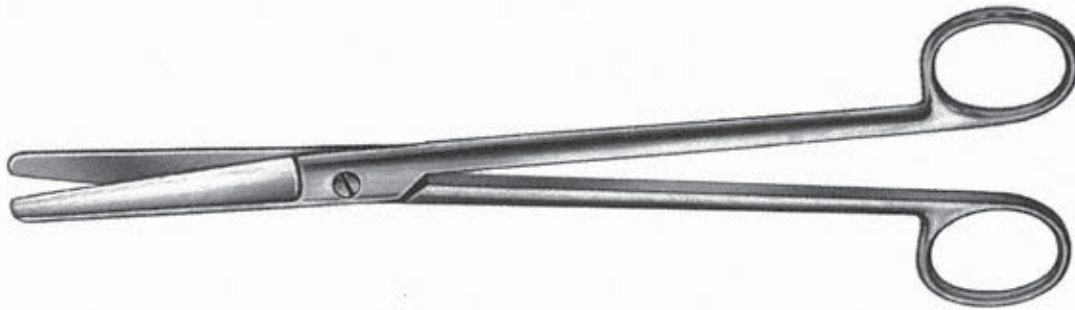

1/1

SIMS

- | | | |
|-----------|--------|--------|
| CI 047 03 | 200 mm | droit |
| CI 047 04 | 200 mm | courbe |
| CI 047 05 | 230 mm | droit |
| CI 047 06 | 230 mm | courbe |

SCHUMACHER - (Cordon Ombilical)

CI 047 07 155 mm

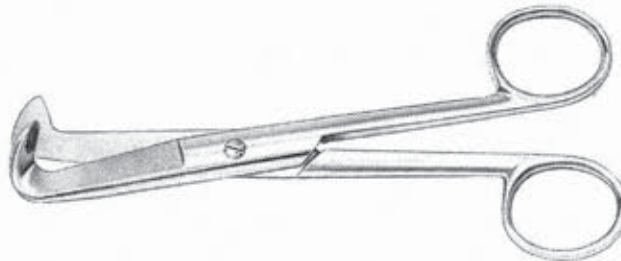

U.S. MODELE - (Cordon Ombilical)

CI 047 08 105 mm



CISEAUX MICRO

CORPS PLATS

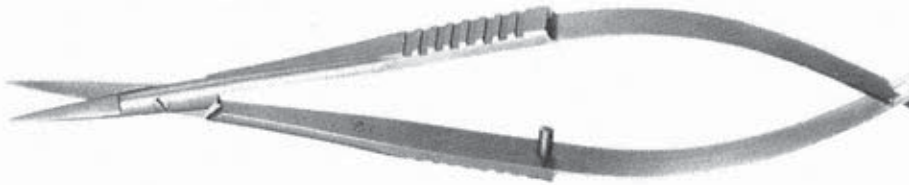

CI 049 01	110 mm	droit
CI 049 02	110 mm	courbe

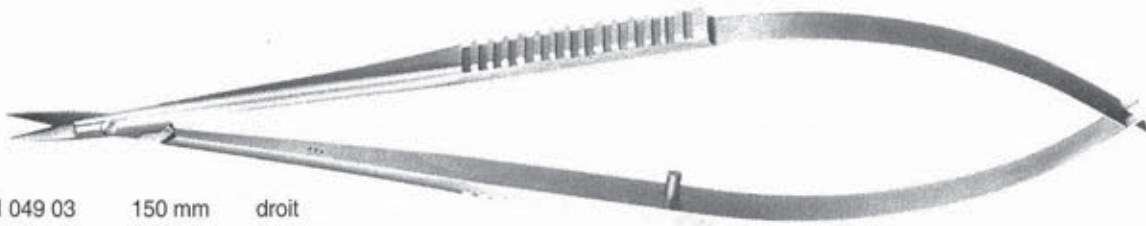

CI 049 03	150 mm	droit
CI 049 04	150 mm	courbe

Lame crantée

CI 049 05	150 mm	droit
CI 049 06	150 mm	courbe

CORPS ROND

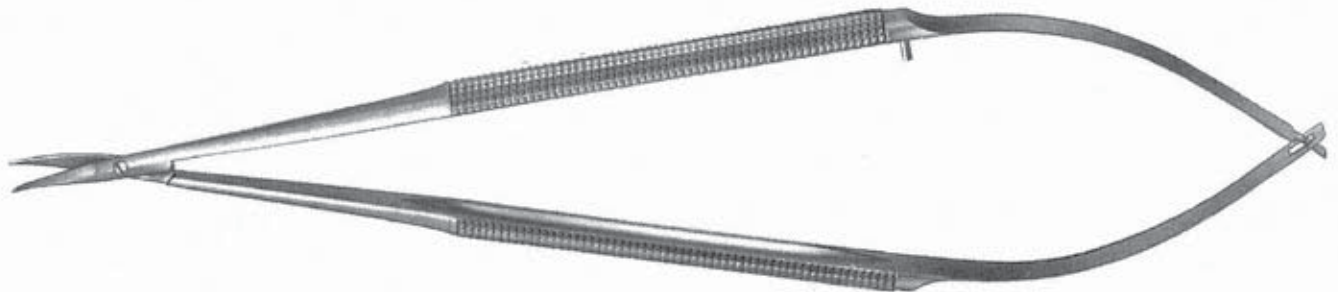

CI 049 07	130 mm	droit
CI 049 08	130 mm	courbe



CI 049 09	150 mm	droit
CI 049 10	150 mm	courbe



CI 049 11	180 mm	droit
CI 049 12	180 mm	courbe



Lames longues

CI 049 13	180 mm	droit
CI 049 14	180 mm	courbe



CISEAUX MICRO

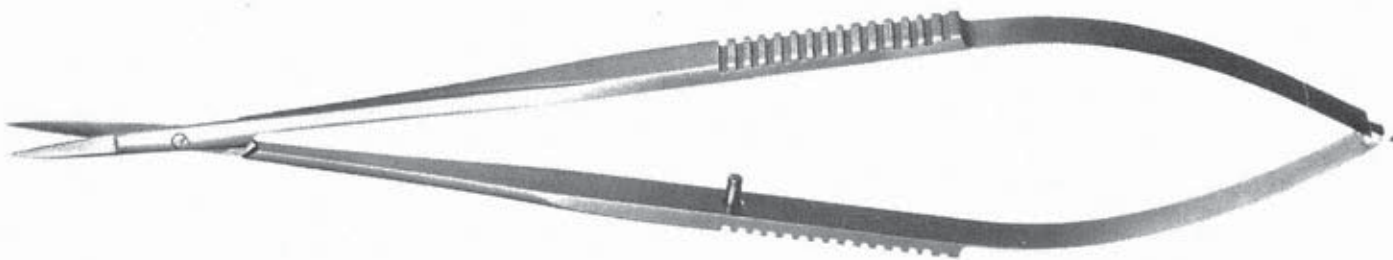

JACOBSON

CI 050 01	150 mm droit
CI 050 02	175 mm droit
CI 050 03	150 mm courbe
CI 050 03	175 mm courbe
CI 050 05	184 mm mousse
CI 050 06	185 mm pointu

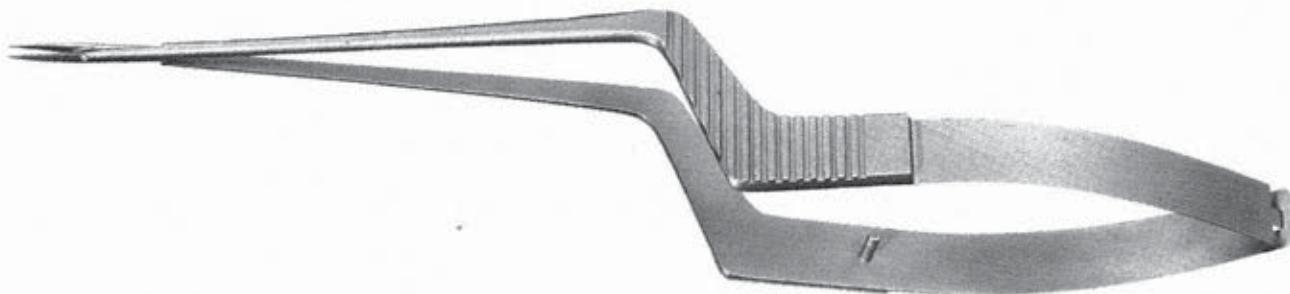
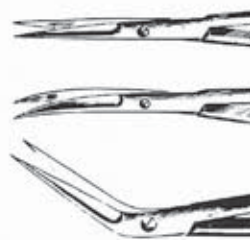

YASARGIL

CI 050 07	200 mm	droit
CI 050 08	200 mm	courbe
CI 050 09	230 mm	courbe

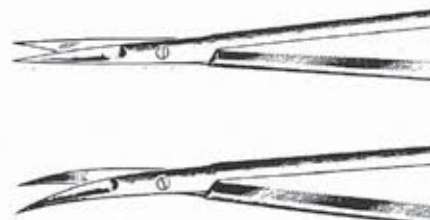



CISEAUX O.R.L. - PLASTIE

BOETTCHER - 180 mm

CI 052 01

courbe

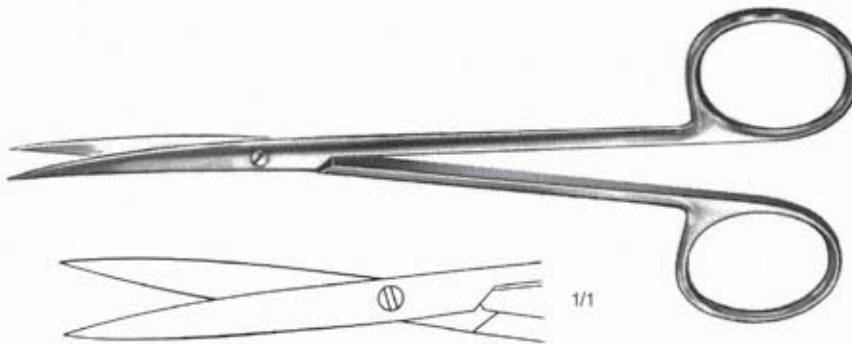
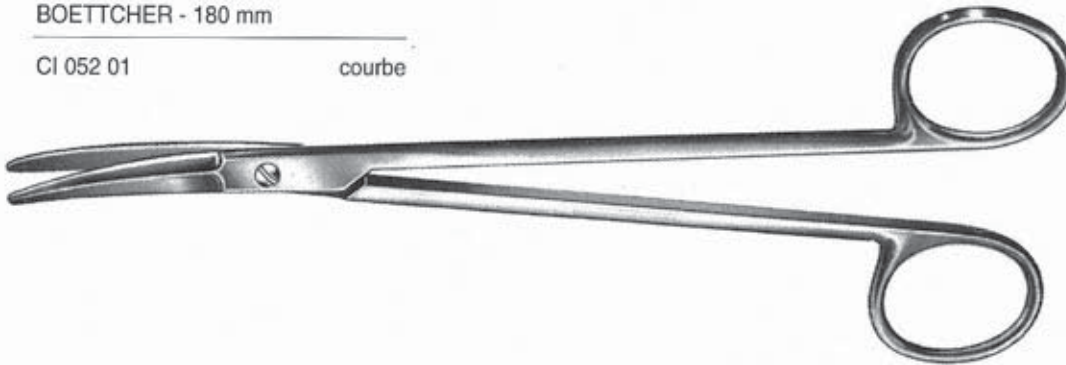

BROPHY - 145 mm

CI 052 02

droit

CI 052 03

courbe

CHADWICK - 115 mm

CI 052 04

très courbe pointu

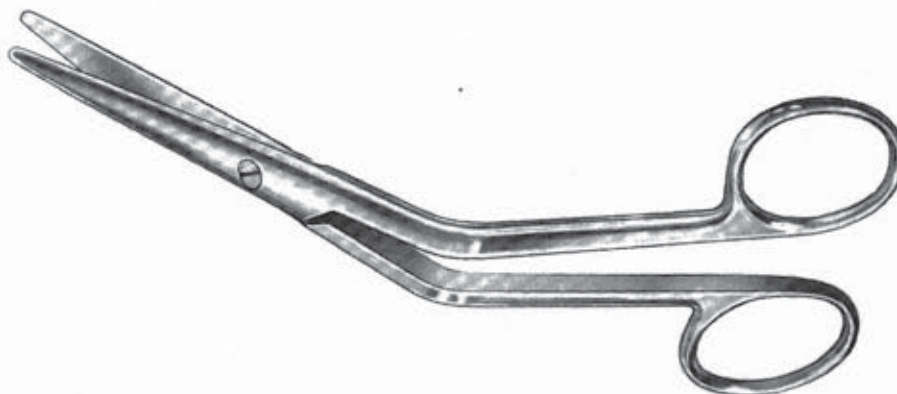
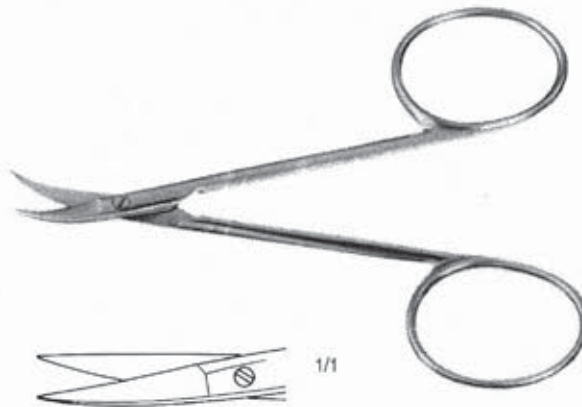

COTTLE - 165 mm

CI 052 05

Rhinoplastie



CISEAUX O.R.L. - PLASTIE

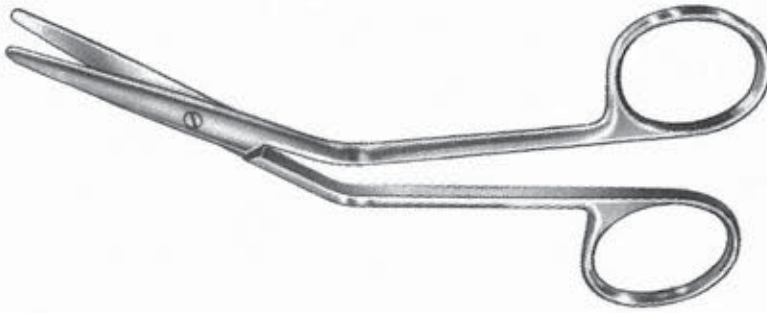

FOMON - 145 mm
CI 053 01 Rhinoplastie

FOMON TUNGSTENE
CI 053 02 145 mm

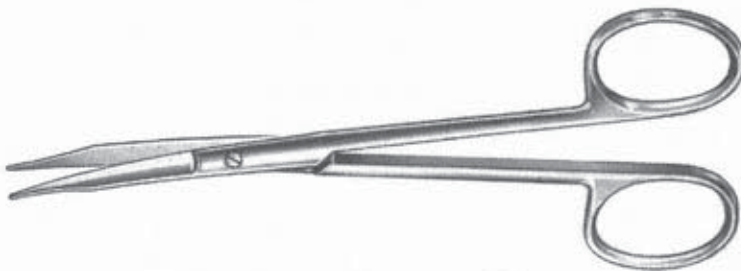
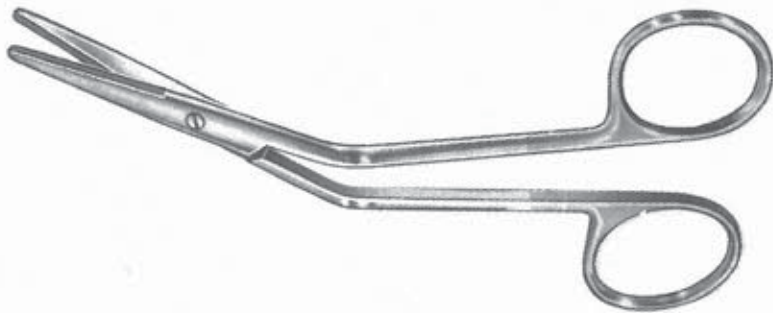

GOLDMANN FOX - 130 lame crantée
CI 053 03 droit
CI 053 04 courbe



GOLDMANN FOX
TUNGSTENE - Lame Crantée
CI 053 05 130 mm

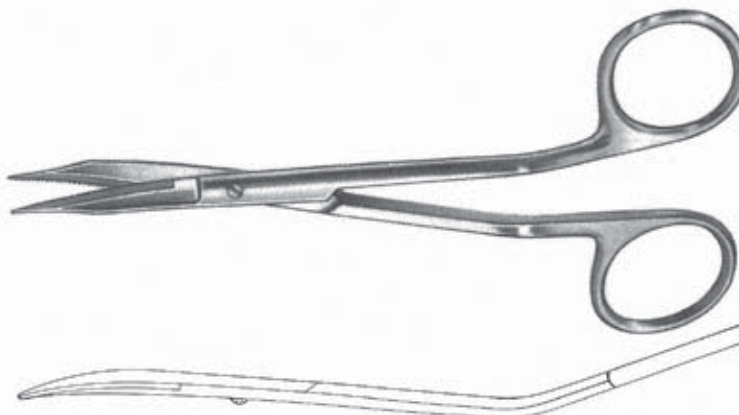

GOLDMANN FOX - TUNGSTENE
Lame Crantée - Angulé
CI 053 06 130 mm



CISEAUX O.R.L. - PLASTIE

GORNEY - 200 mm

- CI 054 01 droit
- CI 054 02 courbe

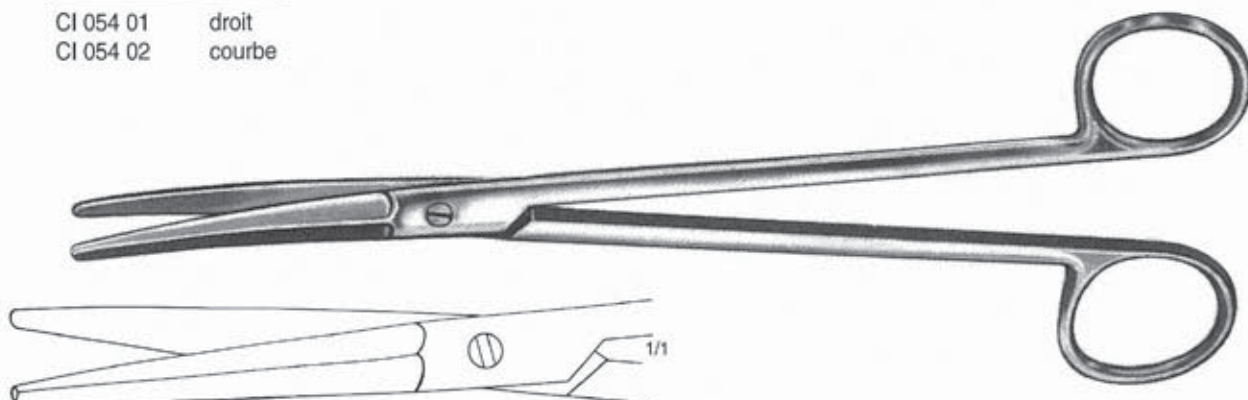

GORNEY TUNGSTENE - 200 mm

- CI 054 03 droit
- CI 054 04 courbe

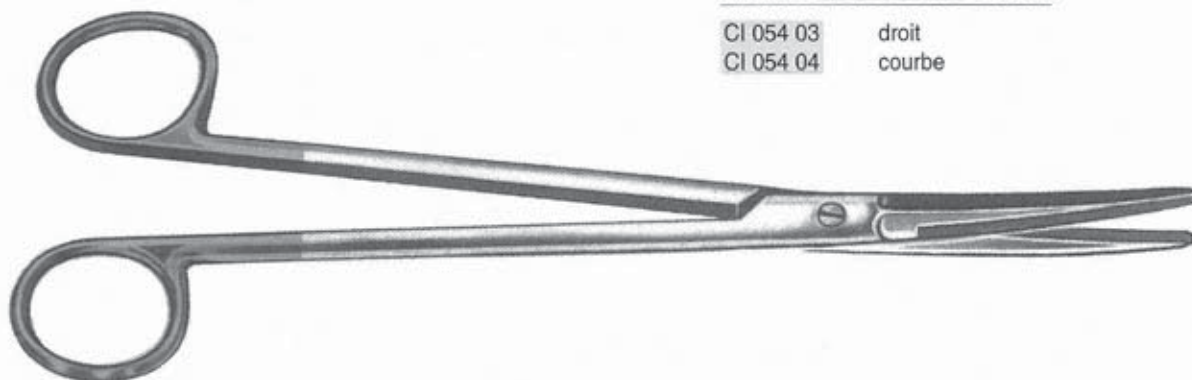

KELLY - 160 mm

- CI 054 05 droit
- CI 054 06 courbe

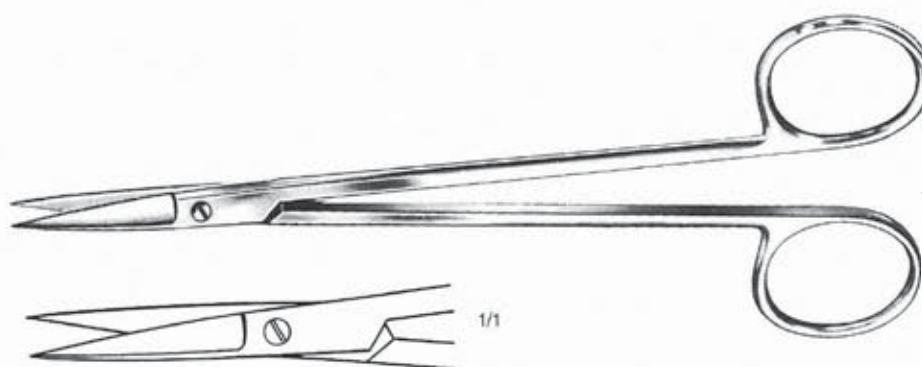

RAGNELL - KILLNER

- CI 054 07 125 mm
- CI 054 08 150 mm

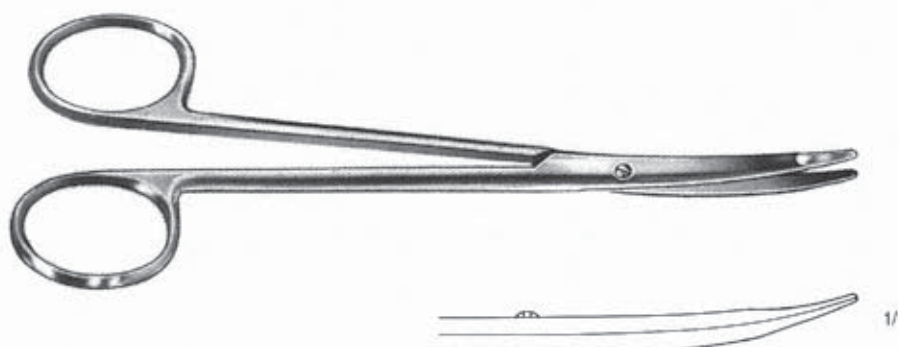



CISEAUX O.R.L. - PLASTIE

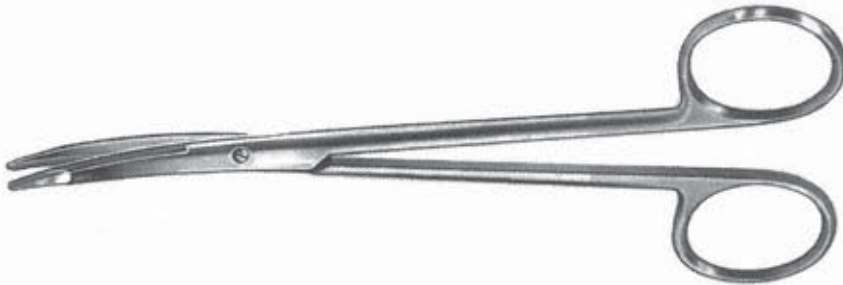

RAGNELL - KILLNER TUNGSTENE

- CI 055 01 120 mm
- CI 055 02 150 mm

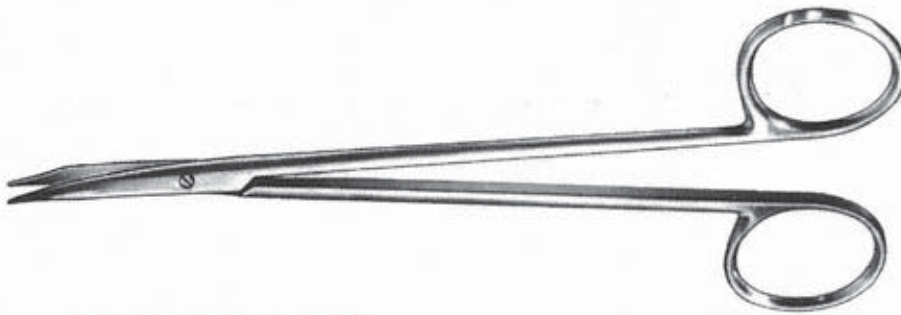

REYNOLDS

- CI 055 03 145 mm



1/1

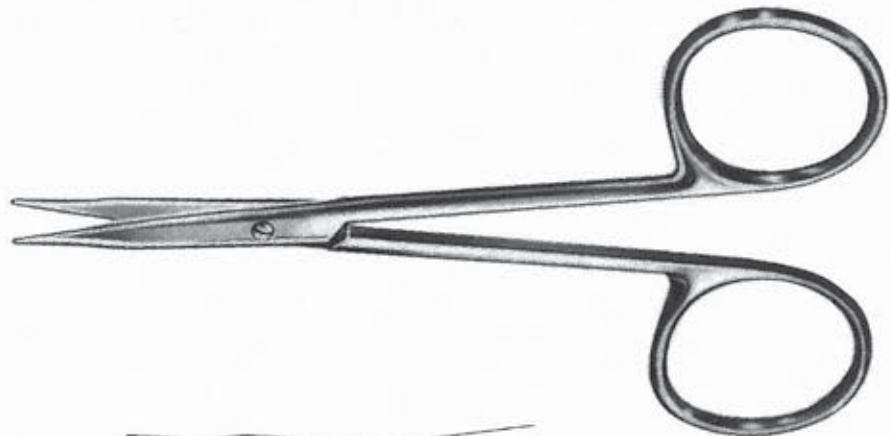

STEVENS - 115 mm Mousse

- CI 055 04 droit
- CI 055 05 courbe



1/1



CISEAUX ONGLES

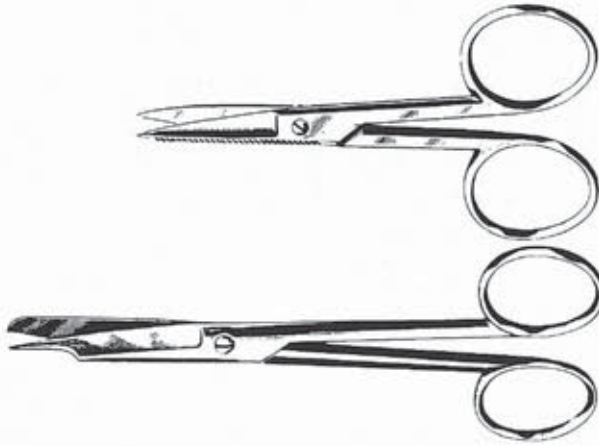

CI 057 01	105 mm	droit
CI 057 02	105 mm	courbe

Ongles incarnés

CI 057 03	140mm
-----------	-------



BANCAL - INOX

	droit	courbe
90 mm	CI 057 05	CI 057 06
100 mm	CI 057 07	CI 057 08
110 mm	CI 057 09	CI 057 10
120 mm	CI 057 11	CI 057 12



PERCY - 90 mm - INOX

CI 057 13	droit
-----------	-------



A ENVIE - 100 mm - INOX

CI 057 14	droit
CI 057 15	courbe



CISEAUX PANSEMENTS - PLATRE



POUR GAZE - Chromé

CI 059 01	200 mm
CI 059 02	220 mm
CI 059 04	280 mm



COUTURIERE - Chromé

CI 059 05	200 mm
CI 059 06	250 mm



BANCAL

CI 059 07	140 mm chromé
CI 059 08	155 mm chromé
CI 059 09	170 mm chromé
CI 059 10	180 mm chromé
CI 059 12	200 mm chromé

LINGERE

CI 059 13	125 mm	chromé
CI 059 14	140 mm	chromé
CI 059 15	155 mm	chromé
CI 059 16	170 mm	chromé
CI 059 18	185 mm	chromé
CI 059 19	200 mm	chromé





CISEAUX PANSEMENTS - PLATRE



ROUANNAIS - chromé

CI 060 01	100 mm
CI 060 02	110 mm
CI 060 03	140 mm

TAILLEUR - chromé

CI 060 04	220 mm
CI 060 05	250 mm
CI 060 06	280 mm

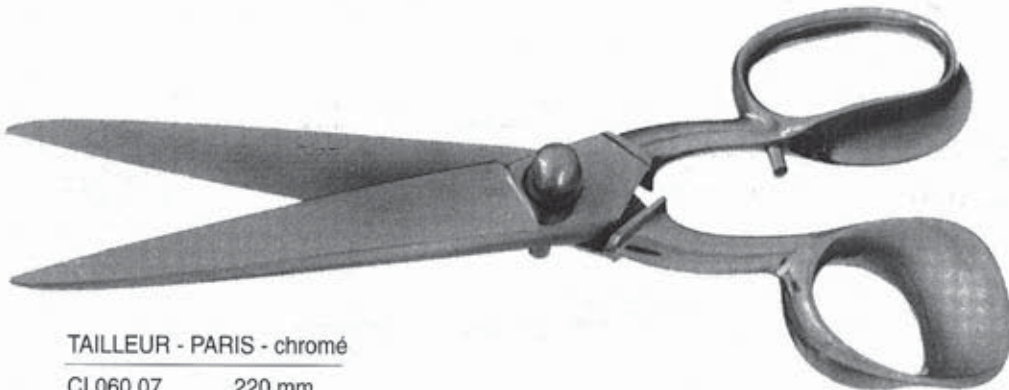
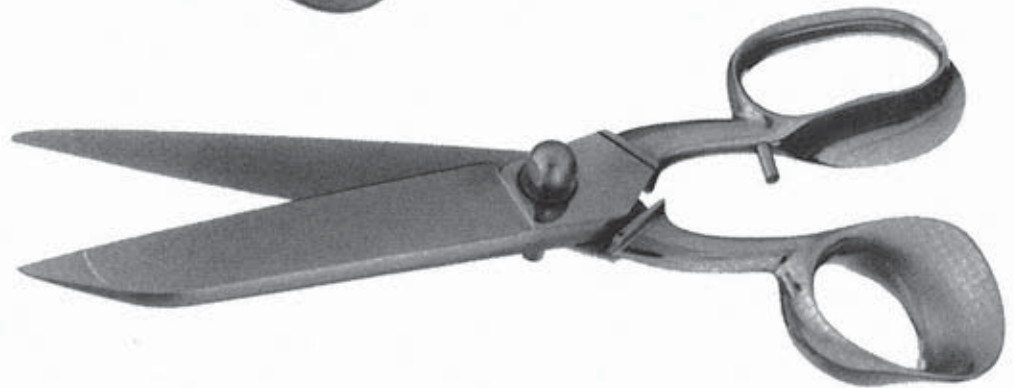

TAILLEUR - PARIS - chromé

CI 060 07	220 mm
CI 060 08	250 mm
CI 060 09	280 mm
CI 060 10	310 mm
CI 060 11	340 mm
CI 060 12	360 mm



LISTER

CI 060 13	140 mm
CI 060 14	180 mm
CI 060 15	200 mm



CISEAUX PANSEMENTS - PLATRE

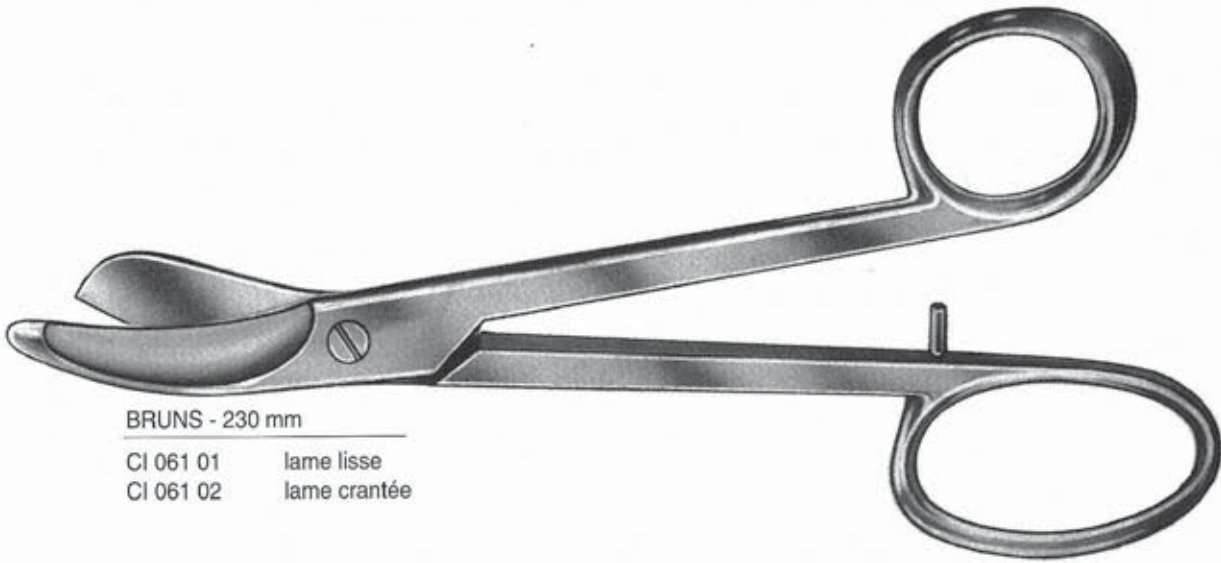

BRUNS - 230 mm

- | | |
|-----------|--------------|
| CI 061 01 | lame lisse |
| CI 061 02 | lame crantée |

UNIVERSEL
anneaux plastique - autoclavable
CI 061 03

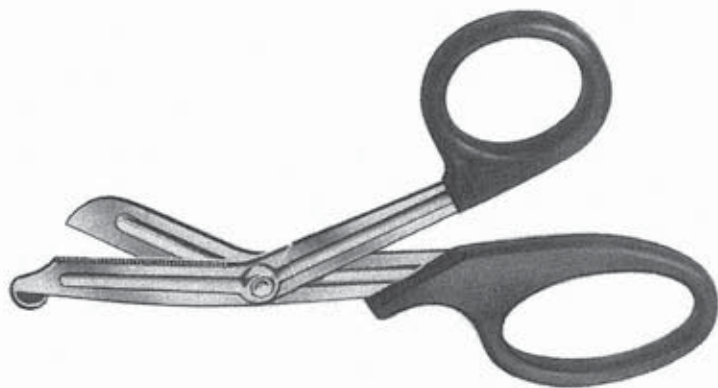



CISEAUX VASCULAIRES



CRAFOORD - 315 mm

CI 063 01 courbe

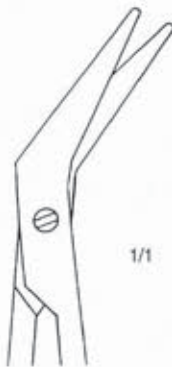
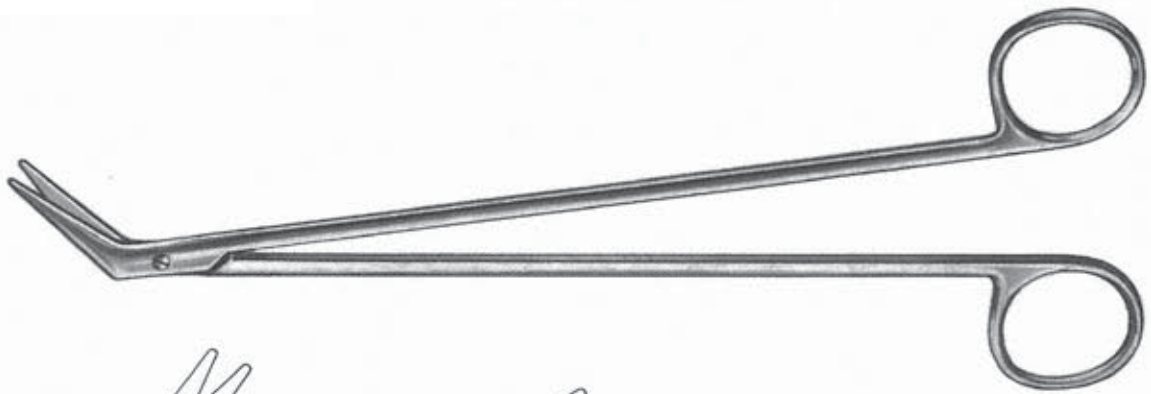

1/1

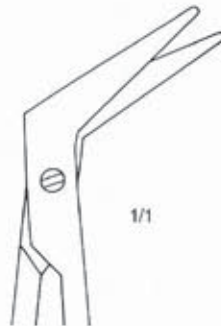

1/1

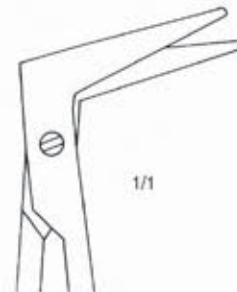

1/1

DE BAKEY

	25°	45°	60°
170 mm	CI 063 02	CI 063 03	CI 063 04
230 mm	CI 063 05	CI 063 06	CI 063 07
280 mm	CI 063 08	CI 063 09	CI 063 10

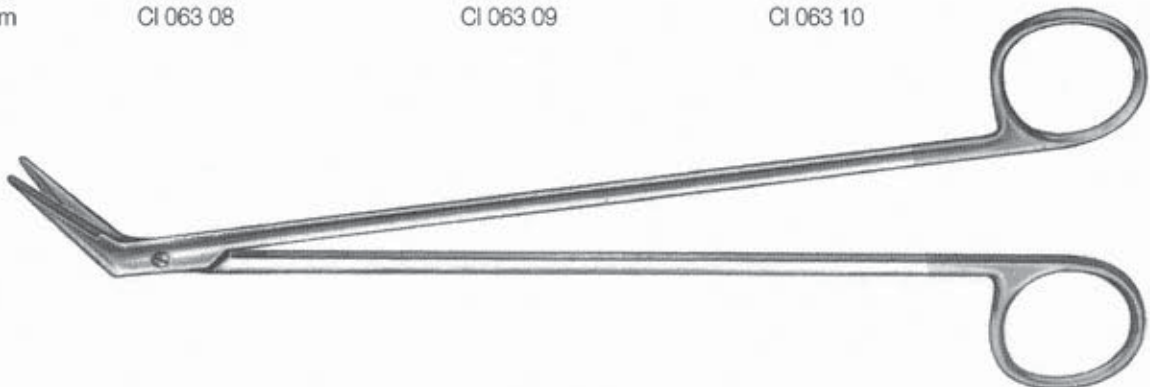

DE BAKEY TUNGSTENE

	25°	45°	60°
180 mm	CI 063 11	CI 063 12	CI 063 13
230 mm	CI 063 14	CI 063 15	CI 063 16
280 mm	CI 063 17	CI 063 18	CI 063 19



CISEAUX VASCULAIRES

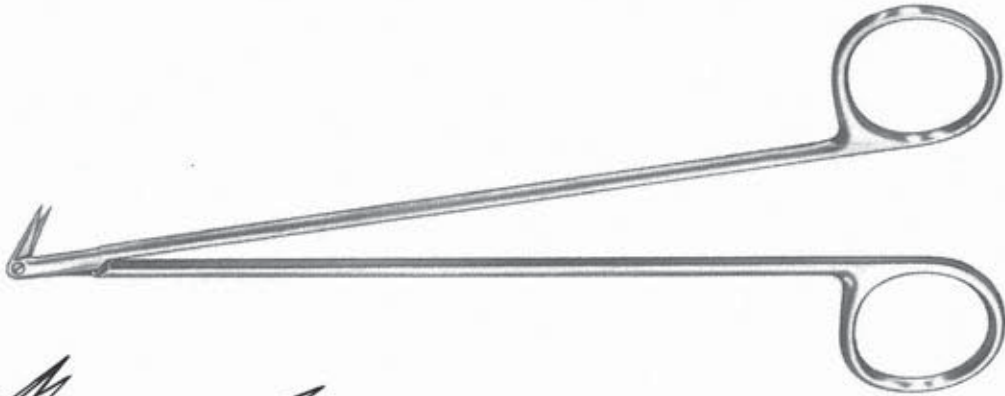

DIETRICH - fin - 180 mm



1/1

CI 064 01

25°



1/1

CI 064 02

45°



1/1

CI 064 03

60°



1/1

CI 064 04

90°



1/1

CI 064 05

125°

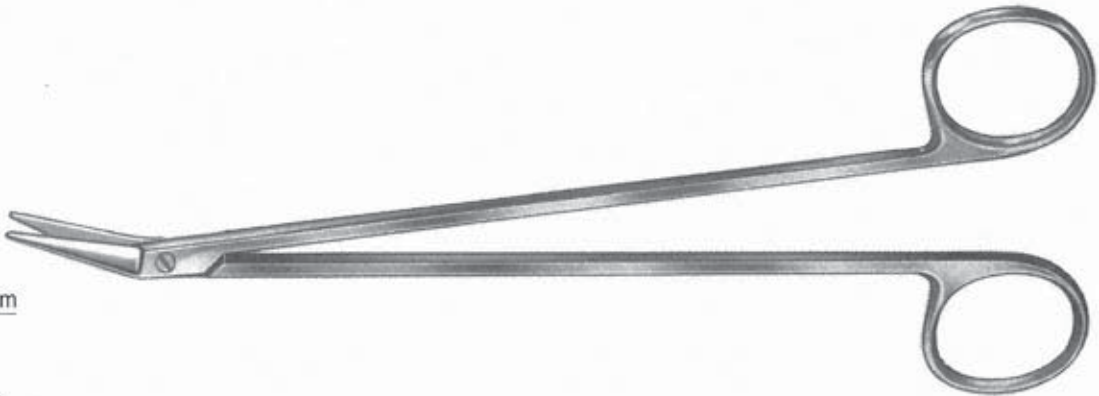

POTTS - MARTEL - 190 mm



1/1

CI 064 06

25°



1/1

CI 064 07

45°

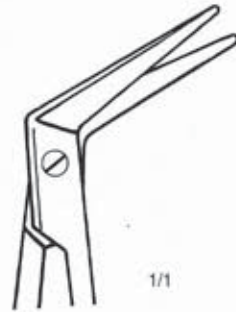

1/1

CI 064 08

60°



CISEAUX VASCULAIRES

POTTS MARTEL - TUNGSTENE - 190 mm

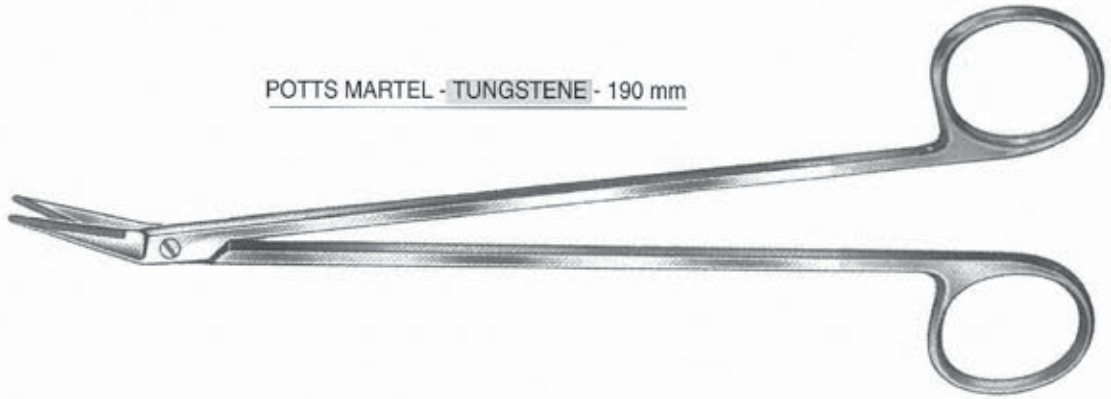

CI 065 01 25°

CI 065 02 45°

CI 065 03 60°

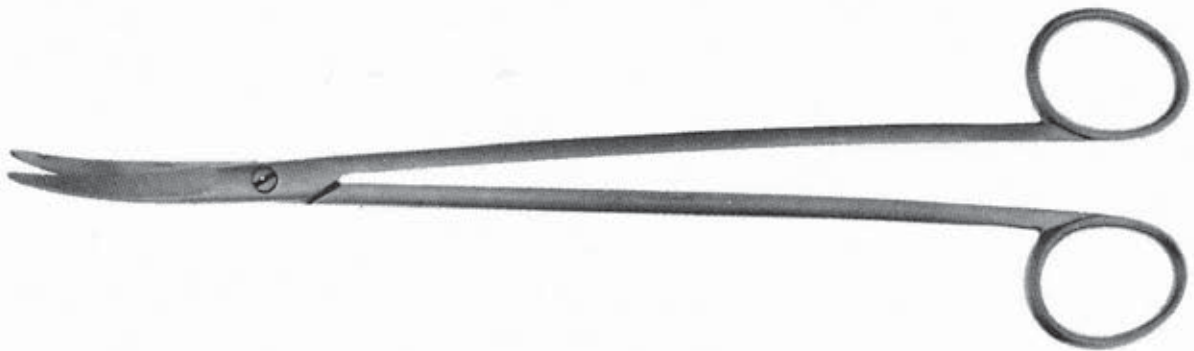

SATINSKY en S

CI 065 04 240 mm

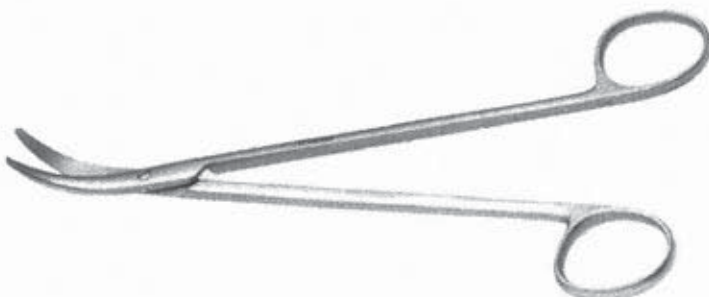

THOREK - très courbe

CI 065 05 190 mm

CI 065 06 250 mm



CISEAUX A OS - BURINS



ALEXANDER - 180 mm

		Largeur
	CI 067 01	4 mm
	CI 067 02	6 mm
	CI 067 03	8 mm
	CI 067 04	10 mm
	CI 067 05	12 mm



FARABEUF - 210 mm

		Largeur
	CI 067 06	10 mm
	CI 067 07	15 mm
	CI 067 08	20 mm
	CI 067 09	25 mm
	CI 067 10	30 mm



FARABEUF - lame mince - 250 mm

		Largeur			Largeur
	CI 067 11	6 mm		CI 067 15	15 mm
	CI 067 12	8 mm		CI 067 16	20 mm
	CI 067 13	10 mm		CI 067 17	25 mm
	CI 067 14	12 mm		CI 067 18	30 mm

1/1



FREER - 160 mm - Largeur 4 mm

CI 067 19	droit
CI 067 20	courbe



CISEAUX A OS - BURINS



HAUTANT - 130 mm

		Largeur
	CI 068 01	2 mm
	CI 068 02	4 mm
	CI 068 03	5 mm
	CI 068 04	6 mm
	CI 068 05	8 mm
	CI 068 06	10 mm
	CI 068 07	12 mm



JUDET - 220 mm

		Largeur
	CI 068 08	10 mm
	CI 068 09	15 mm
	CI 068 10	20 mm
	CI 068 11	25 mm
	CI 068 12	30 mm
	CI 068 13	35 mm



LEBSCHKE - STERNUM - 245 mm

CI 068 14



LETOURNEL - 350 mm

Pour ciment

CI 068 15 Largeur 6 mm



MEDLANE

CI-O

CISEAUX A OS - BURINS



LUCAS CHAMPIONNIERE - 210 mm

CI 069 01 Largeur - 35 mm



MAC EVEN - 200 mm - gradué droit

Largeur

CI 069 02 10 mm
CI 069 03 15 mm
CI 069 04 20 mm



MANET - 130 mm - pour pédicure

CI 069 05 Largeur - 3,5 mm



OMBREDANNE - 140 mm - lame mince

Largeur

CI 069 06 10 mm
CI 069 07 15 mm
CI 069 08 20 mm



PARTSCH









		Largeur	longueur
□	CI 069 09	2 mm	140 mm
	CI 069 10	2 mm	170 mm
□	CI 069 11	3 mm	140 mm
	CI 069 12	3 mm	170 mm

		Largeur	longueur
□	CI 069 13	4 mm	140 mm
	CI 069 14	4 mm	170 mm
□	CI 069 15	6 mm	140 mm
	CI 069 16	6 mm	170 mm
□	CI 069 17	8 mm	140 mm
	CI 069 18	8 mm	170 mm



STILLE - 210 mm

Largeur

	CI 071 01	6 mm
	CI 071 02	8 mm
	CI 071 03	10 mm
	CI 071 04	12 mm
	CI 071 05	15 mm
	CI 071 06	20 mm
	CI 071 07	25 mm
	CI 071 08	30 mm



CISEAUX A OS - GOUGES



ALEXANDER - 180 mm

Largeur

	CI 073 01	4 mm
	CI 073 02	6 mm
	CI 073 03	8 mm
	CI 073 04	10 mm
	CI 073 05	12 mm



BALLENGER - 150 mm

Largeur

CI 073 06	4 mm
CI 073 07	6 mm



CAUCHOIX - 250 mm

Concave Largeur

	CI 073 08	16 mm
	CI 073 09	18 mm
	CI 073 10	20 mm

Convexe Largeur

	CI 073 11	16 mm
	CI 073 12	18 mm
	CI 073 13	20 mm



COBB - 300 mm

Largeur 6 mm

CI 073 14	droite
CI 073 15	1/2 courbe
CI 073 16	courbe



COBB - 280 mm

Largeur

	CI 073 17	8 mm
	CI 073 18	10 mm
	CI 073 19	12 mm



CISEAUX A OS - GOUGES

GUILLAUME - 240 mm

	Largeur	
CI 074 01	2 mm	
CI 074 02	4 mm	
CI 074 03	6 mm	
CI 074 04	8 mm	



HAUTANT - 130 mm

		Largeur			Largeur
	CI 074 05	2 mm		CI 074 09	8 mm
	CI 074 06	4 mm		CI 074 10	10 mm
	CI 074 07	5 mm		CI 074 11	12 mm
	CI 074 08	6 mm			



HONTON - 295 mm

Largeur - 16 mm



CI 074 12 droite



CI 074 13 concave



CI 074 14 convexe

KILLIAN - 160 mm

CI 074 15 Largeur - 5 mm





CISEAUX A OS - GOUGES

LETOURNEL - 370 mm



Pour ciment
CI 075 01

Largeur - 6 mm



LEXER - 220 mm - manche synthétique

		Largeur			Largeur
	CI 075 02	7 mm		CI 075 05	20 mm
	CI 075 03	10 mm		CI 075 06	30 mm
	CI 075 04	15 mm			

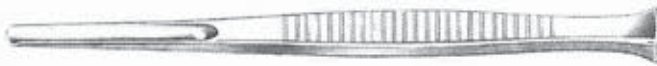

PARTSCH

		Largeur	longueur			Largeur	longueur
	CI 075 07	2 mm	140 mm		CI 075 13	6 mm	140 mm
	CI 075 08	2 mm	170 mm		CI 075 14	6 mm	170 mm
	CI 075 09	3 mm	140 mm		CI 075 15	8 mm	140 mm
	CI 075 10	3 mm	170 mm		CI 075 16	8 mm	170 mm
	CI 075 11	4 mm	140 mm				
	CI 075 12	4 mm	170 mm				



PEDICURE - 145 mm

		Largeur			Largeur		Largeur	
	CI 075 17	1 mm		CI 075 22	5 mm		CI 075 27	10 mm
	CI 075 18	1,5 mm		CI 075 23	6 mm		CI 075 28	12 mm
	CI 075 19	2 mm		CI 075 24	7 mm		CI 075 29	13 mm
	CI 075 20	3 mm		CI 075 25	8 mm		CI 075 30	14 mm
	CI 075 21	4 mm		CI 075 26	9 mm		CI 075 31	15 mm



CISEAUX A OS - GOUGES



POIRIER - 160 mm

Largeur

	CI 076 01	2 mm
	CI 076 02	4 mm
	CI 076 03	6 mm
	CI 076 04	8 mm
	CI 076 05	10 mm
	CI 076 06	12 mm
	CI 076 07	14 mm



POIRIER - TRILLAT - 200 mm

Largeur

	CI 076 08	4 mm
	CI 076 09	6 mm
	CI 076 10	8 mm
	CI 076 11	10 mm
	CI 076 12	12 mm
	CI 076 13	14 mm

POSTEL - 250 mm

Largeur - 8 mm

CI 076 14	droite
CI 076 15	coudée 135°
CI 076 16	coudée 150°



PUTTI - 250 mm

CI 076 17 Largeur - 30 mm





CISEAUX A OS - GOUGES



SMITH - PETERSEN - 235 mm

		Largeur
	CI 077 01	20 mm
	CI 077 02	27 mm
	CI 077 03	30 mm



STAGNARA - 300 mm

		Largeur			Largeur
	CI 077 04	6 mm		CI 077 08	14 mm
	CI 077 05	8 mm		CI 077 09	16 mm
	CI 077 06	10 mm		CI 077 10	18 mm
	CI 077 07	12 mm		CI 077 11	20 mm



STILLE - 210 mm

		Largeur
	CI 077 12	6 mm
	CI 077 13	8 mm
	CI 077 14	10 mm
	CI 077 15	12 mm
	CI 077 16	15 mm
	CI 077 17	20 mm
	CI 077 18	25 mm
	CI 077 19	30 mm



ZIELKE - 230 mm - manche synthétique

		Largeur
	CI 077 20	5,5 mm
	CI 077 21	9 mm



CISEAUX A OS - OSTEOTOMES



CAUCHOIX - 250 mm

		largeur
	CI 080 01	8 mm
	CI 080 02	10 mm
	CI 080 03	12 mm
	CI 080 04	14 mm
	CI 080 05	16 mm
	CI 080 06	18 mm
	CI 080 07	20 mm
	CI 080 08	25 mm



FARABEUF - 210 mm

		largeur
	CI 080 09	10 mm
	CI 080 10	12 mm
	CI 080 11	15 mm
	CI 080 12	20 mm
	CI 080 13	25 mm
	CI 080 14	30 mm



CISEAUX A OS - OSTEOTOMES



LAMBOTTE

		Largeur	Longueur			Largeur	Longueur
┌	CI 081 01	6 mm	125 mm	┐	CI 081 17	25 mm	160 mm
	CI 081 02	6 mm	160 mm		CI 081 18	25 mm	240 mm
	CI 081 03	6 mm	240 mm				
┌	CI 081 04	8 mm	125 mm	┐	CI 081 19	30 mm	160 mm
	CI 081 05	8 mm	160 mm		CI 081 20	30 mm	240 mm
	CI 081 06	8 mm	240 mm				
┌	CI 081 07	10 mm	125 mm	┐	CI 081 21	35 mm	160 mm
	CI 081 08	10 mm	160 mm		CI 081 22	35 mm	240 mm
	CI 081 09	10 mm	240 mm				
┌	CI 081 10	12 mm	125 mm	┐	CI 081 23	40 mm	160 mm
	CI 081 11	12 mm	160 mm		CI 081 24	40 mm	240 mm
	CI 081 12	12 mm	240 mm				
┌	CI 081 13	14 mm	160 mm	┐	CI 081 25	50 mm	160 mm
	CI 081 14	14 mm	240 mm		CI 081 26	50 mm	240 mm
┌	CI 081 15	20 mm	160 mm				
	CI 081 16	20 mm	240 mm				



LEXER - 220 mm - manche synthétique

		Largeur
┌	CI 081 27	7 mm
	CI 081 28	10 mm
	CI 081 29	15 mm
	CI 081 30	20 mm
	CI 081 31	25 mm
	CI 081 32	30 mm



CISEAUX A OS - OSTEOTOMES



ROBIN - 160 mm

largeur Tranchant

	CI 082 01	6 mm
	CI 082 02	8 mm
	CI 082 03	10 mm
	CI 082 04	14 mm



STILLE - 210 mm - droit

largeur

	CI 082 05	6 mm
	CI 082 06	8 mm
	CI 082 07	10 mm
	CI 082 08	12 mm
	CI 082 09	15 mm
	CI 082 10	20 mm
	CI 082 11	25 mm
	CI 082 12	30 mm



STILLE - 210 mm - courbe

largeur

	CI 082 13	10 mm
	CI 082 14	12 mm
	CI 082 15	15 mm
	CI 082 16	20 mm
	CI 082 17	25 mm
	CI 082 18	30 mm



CLAMPS BULLDOG



Modèle fin

	droit	courbe
35 mm	CL 086 01	CL 086 02
40 mm	CL 086 03	CL 086 04
50 mm	CL 086 05	CL 086 06
60 mm	CL 086 07	CL 086 08
70 mm	CL 086 09	CL 086 10

Modèle fort

	droit	courbe
35 mm	CL 086 11	CL 086 12
40 mm	CL 086 13	CL 086 14
50 mm	CL 086 15	CL 086 16
60 mm	CL 086 17	CL 086 18
70 mm	CL 086 19	CL 086 20



Micro droit

	longueur totale x longueur mors
CL 086 21	50 mm x 8 mm
CL 086 22	50 mm x 12 mm
CL 086 23	60 mm x 16 mm

Micro courbe

	longueur totale x longueur mors
CL 086 24	45 mm x 8 mm
CL 086 25	45 mm x 12 mm
CL 086 26	55 mm x 16 mm



CLAMPS BULLDOG



DE BAKY - droit

longueur totale x longueur mors

	CL 087 01	80 mm x 23 mm
	CL 087 02	90 mm x 33 mm
	CL 087 03	105 mm x 48 mm
	CL 087 04	125 mm x 68 mm



DE BAKY - courbe

longueur totale x longueur mors

	CL 087 05	75 mm x 18 mm
	CL 087 06	85 mm x 30 mm
	CL 087 07	95 mm x 40 mm
	CL 087 08	115 mm x 57 mm

MICRO - DE BAKY

longueur totale x longueur mors

	CL 087 09	60 mm x 20 mm	droit
	CL 087 10	56 mm x 18 mm	courbe





CLAMPS BULLDOG

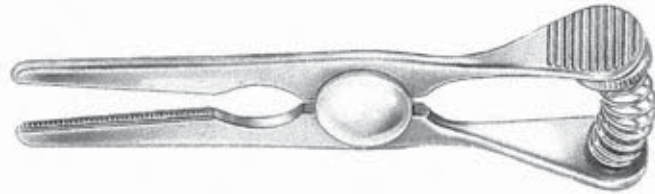

GLOVER - droit

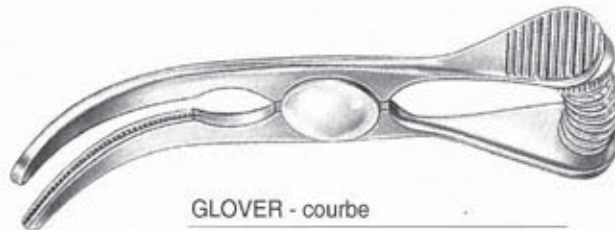

longueur totale x longueur mors

	CL 088 01	70 mm x 30 mm
	CL 088 02	90 mm x 45 mm
	CL 088 03	105 mm x 56 mm



GLOVER - courbe

longueur totale x longueur mors

	CL 088 04	65 mm x 30 mm
	CL 088 05	85 mm x 43 mm
	CL 088 06	100 mm x 56 mm



CLAMPS BULLDOG

MICRO GLOVER

longueur totale x longueur mors



CL 089 01 35 mm x 14 mm droit



CL 089 02 30 mm x 14 mm courbe

PINCE A POSER LES CLAMPS

CL 089 03 230 mm

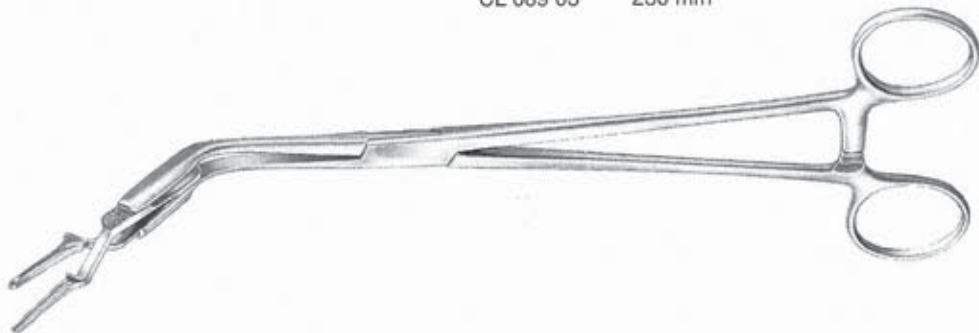



CLAMPS DIGESTIFS

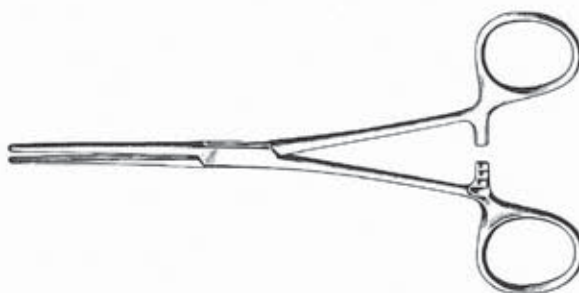

BAINBRIDGE



1/1

CL 091 01	150 mm	droit
CL 091 02	185 mm	droit



1/1

CL 091 03	150 mm	courbe
CL 091 04	185 mm	courbe

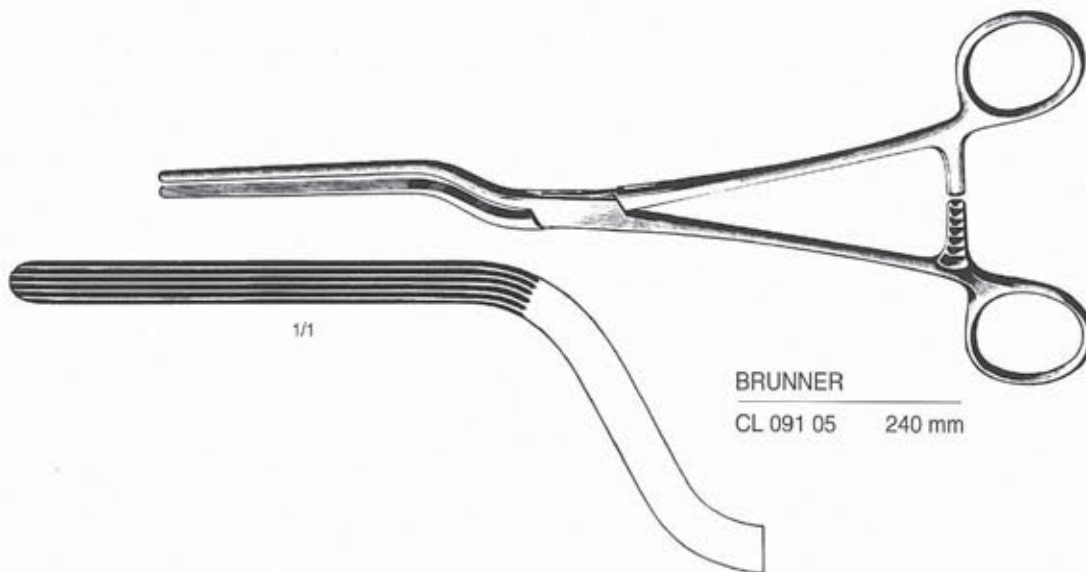

1/1

BRUNNER

CL 091 05	240 mm
-----------	--------

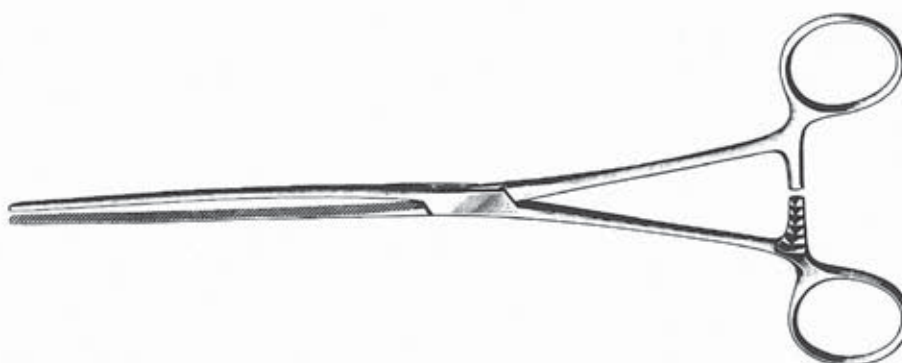

DOYEN

CL 091 06	180 mm	droit
CL 091 07	180 mm	courbe
CL 091 08	210 mm	droit
CL 091 09	210 mm	courbe
CL 091 10	230 mm	droit
CL 091 11	230 mm	courbe



CLAMPS DIGESTIFS

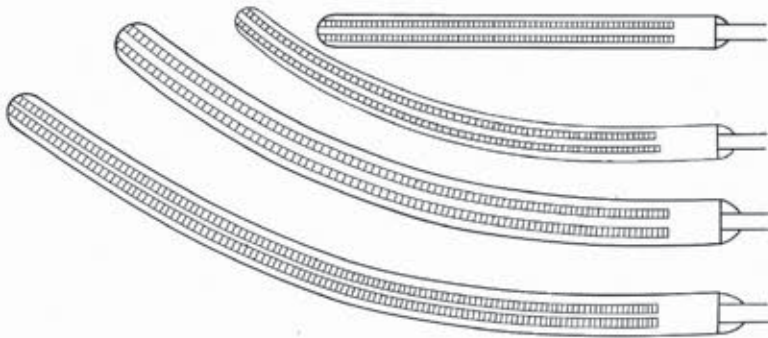
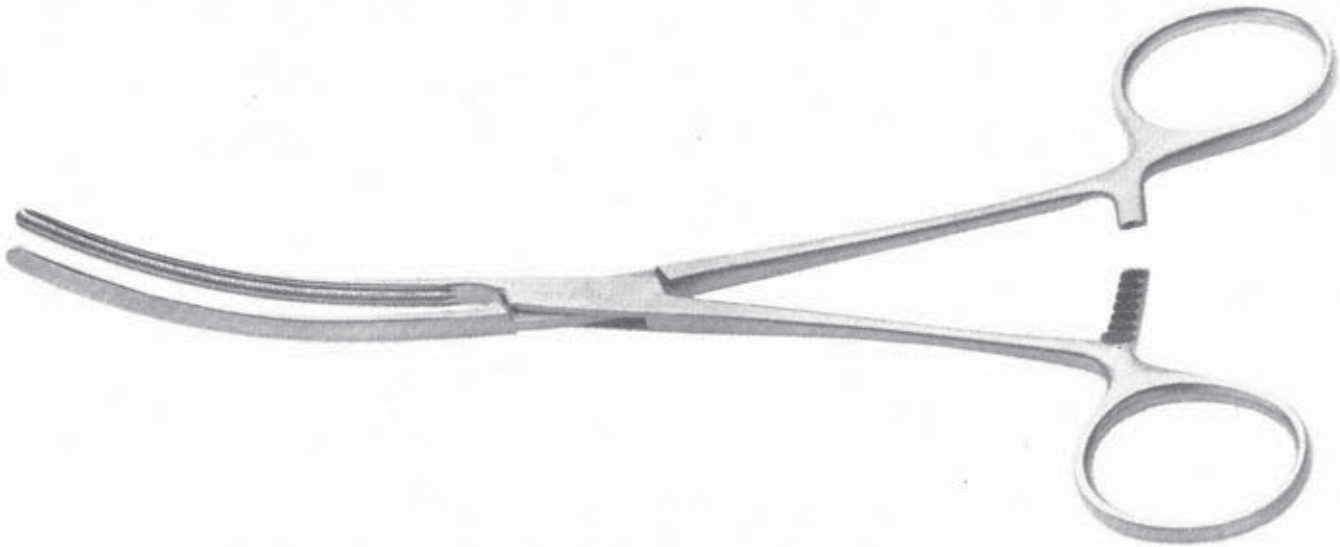

DOYEN - ATRAUMATIQUE

CL 092 01	130 mm	droit
CL 092 02	130 mm	courbe
CL 092 03	180 mm	droit
CL 092 04	180 mm	courbe
CL 092 05	210 mm	droit
CL 092 06	210 mm	courbe
CL 092 07	230 mm	droit
CL 092 08	230 mm	courbe

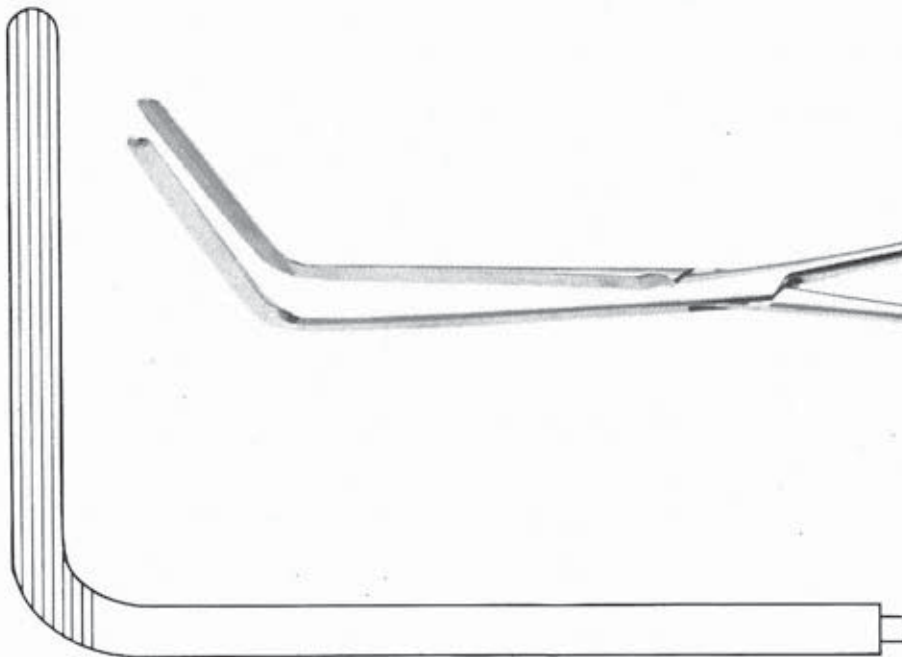

FEHLAND

CL 092 09	240 mm
-----------	--------



CLAMPS DIGESTIFS

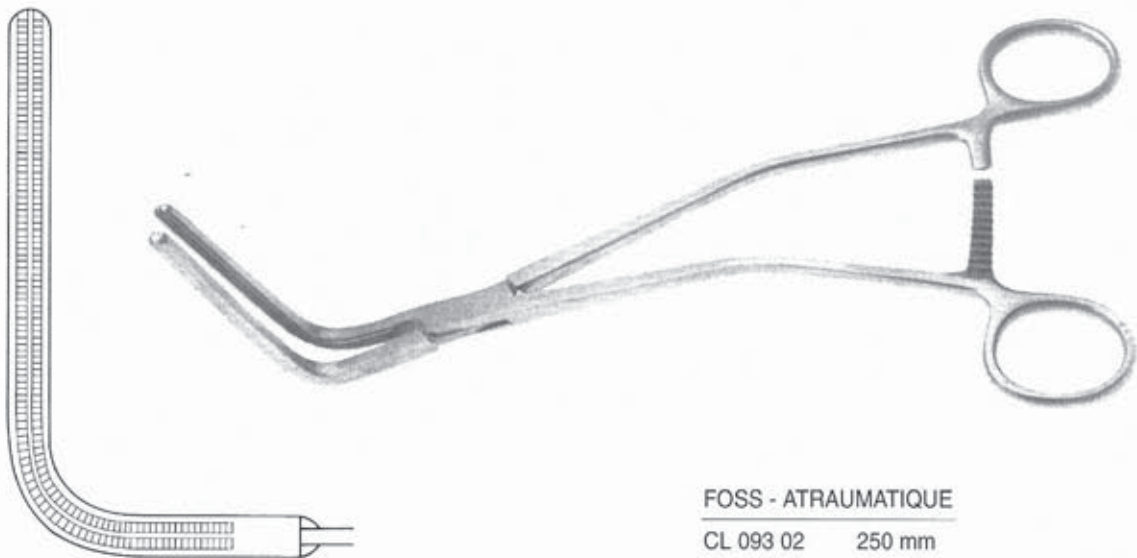
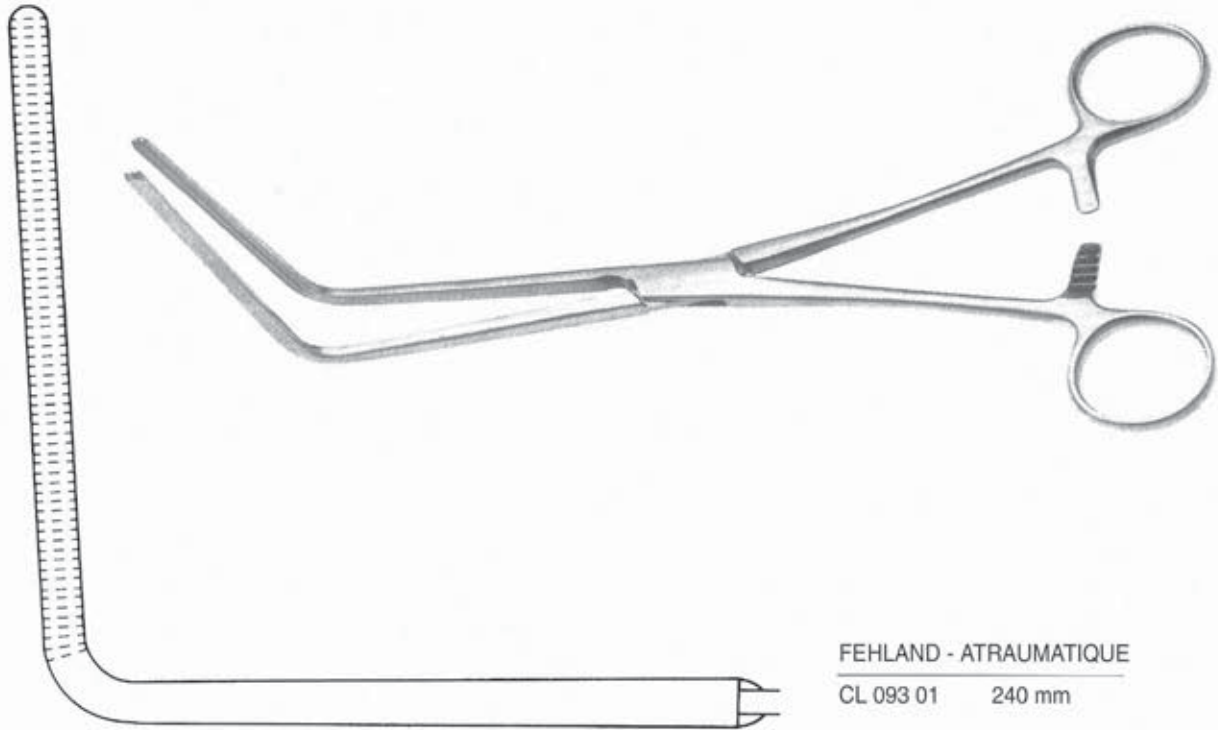



CLAMPS DIGESTIFS

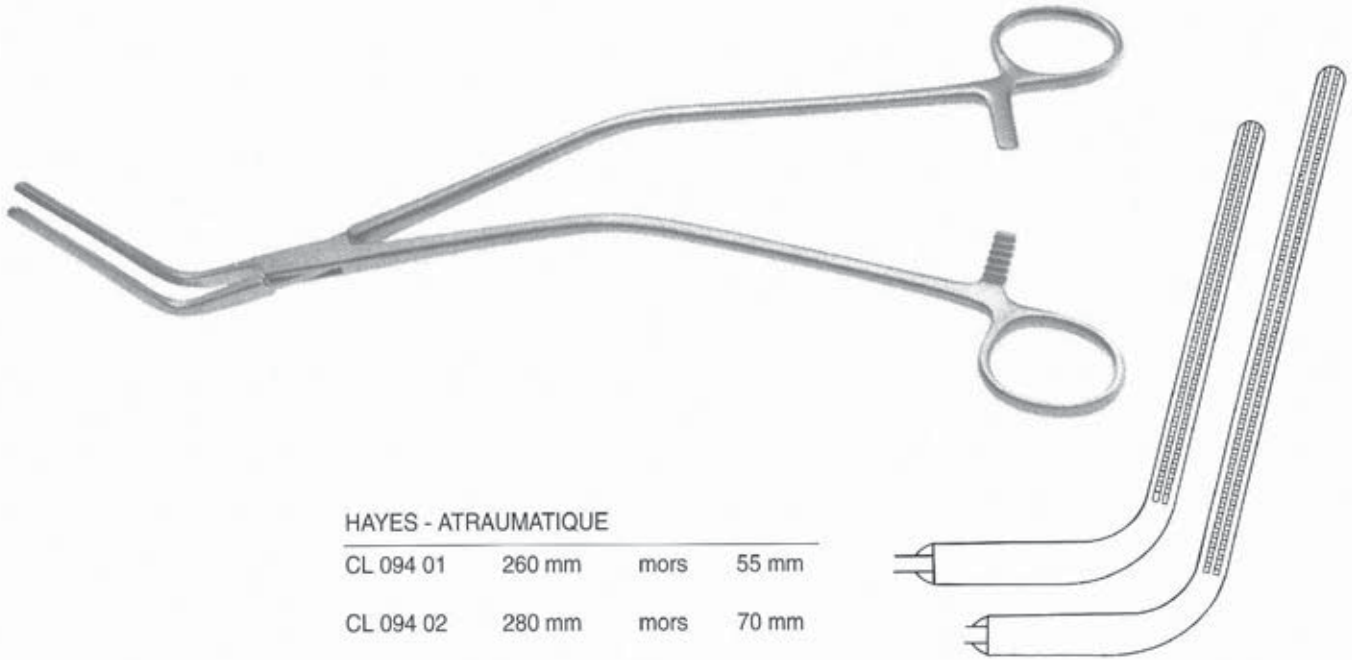

HAYES - ATRAUMATIQUE

CL 094 01	260 mm	mors	55 mm
-----------	--------	------	-------

CL 094 02	280 mm	mors	70 mm
-----------	--------	------	-------

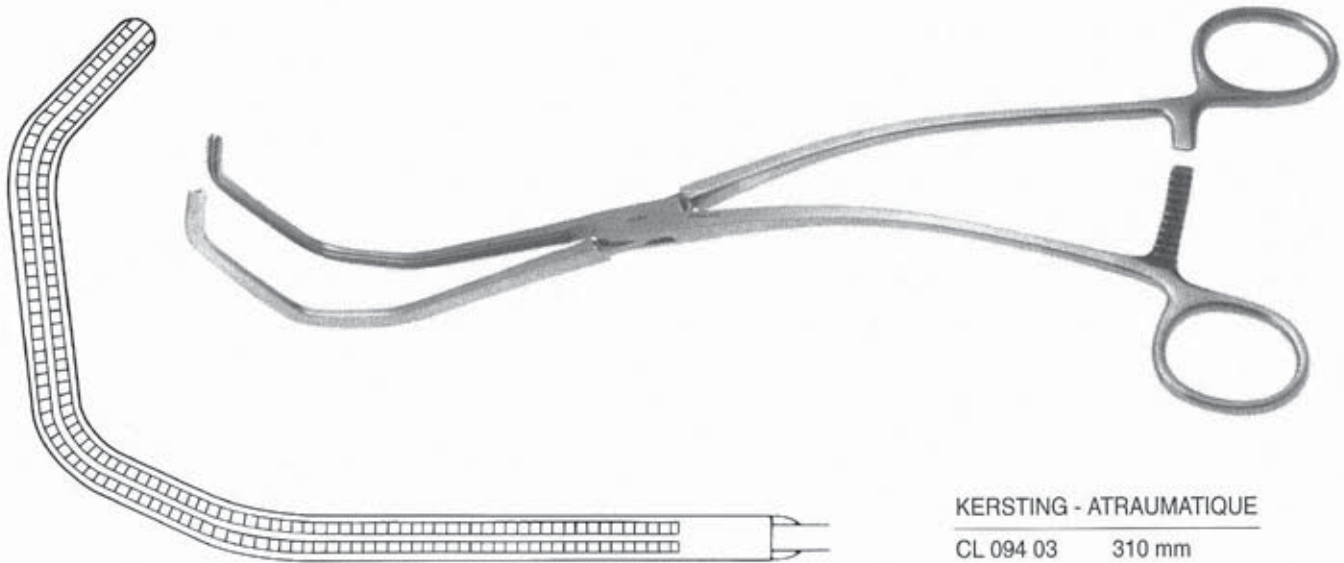

KERSTING - ATRAUMATIQUE

CL 094 03	310 mm
-----------	--------



CLAMPS DIGESTIFS

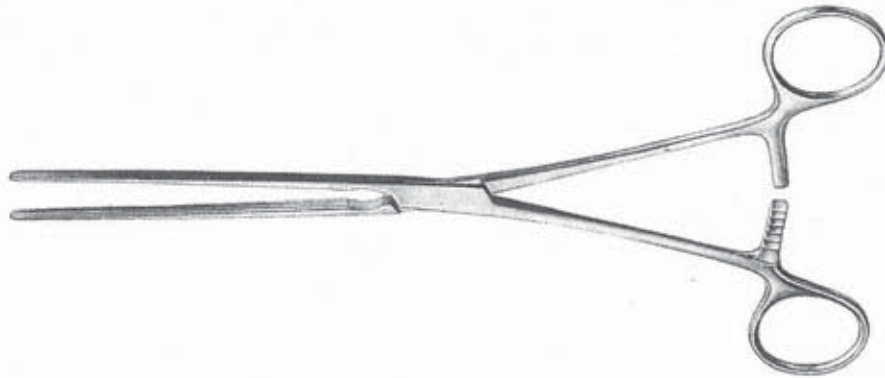

KOCHER - droit

CL 095 01	220 mm
CL 095 02	250 mm
CL 095 03	280 mm



KOCHER - courbe

CL 095 04	220 mm
CL 095 05	250 mm
CL 095 06	280 mm

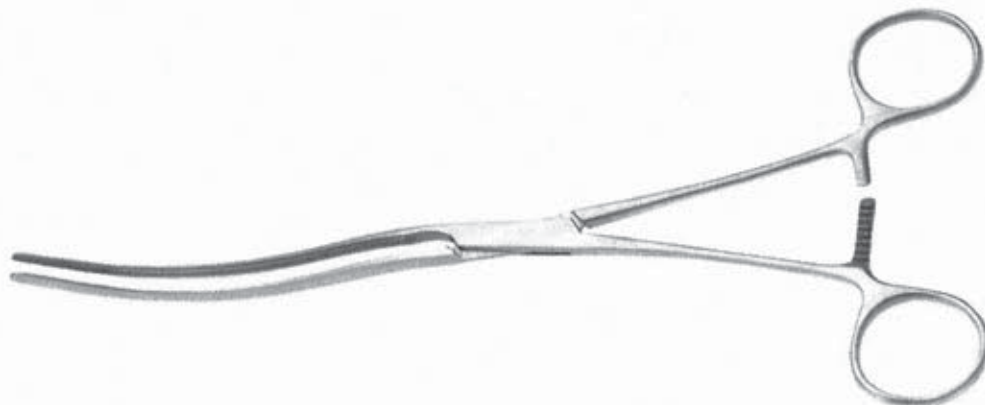

KOCHER - ATRAUMATIQUE - droit

CL 095 07	230 mm
CL 095 08	250 mm
CL 095 09	270 mm



KOCHER - ATRAUMATIQUE - courbe

CL 095 10	230 mm
CL 095 11	250 mm
CL 095 12	270 mm





CLAMPS DIGESTIFS

LANE

CL 096 01	310 mm	droit
CL 096 02	310 mm	courbe

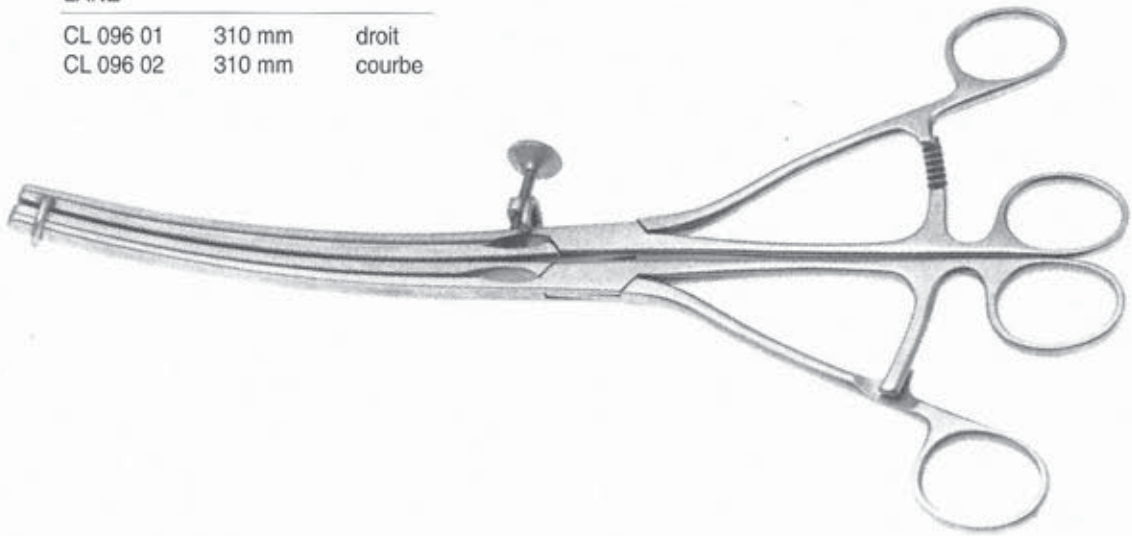

SCUDER - ATRAUMATIQUE

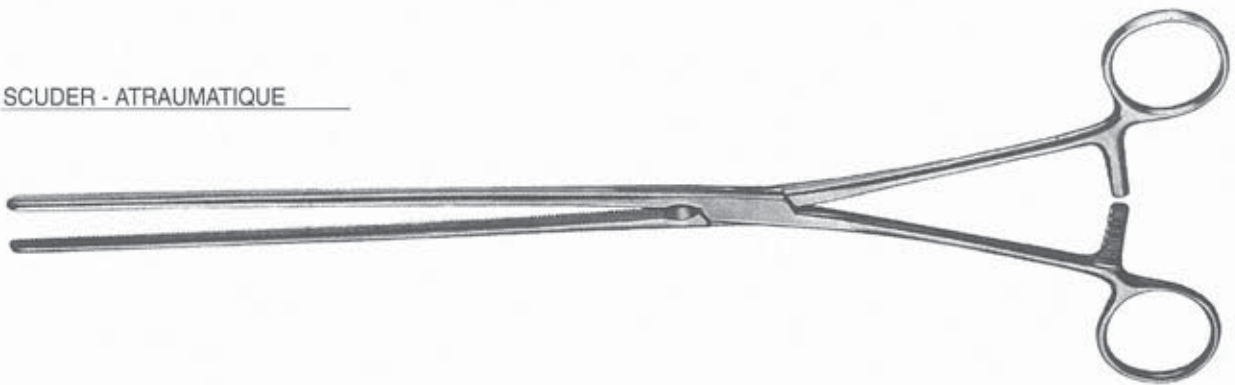

CL 096 03 330 mm droit

CL 096 04 320 mm courbe



CLAMPS VASCULAIRES ANASTOMOSES

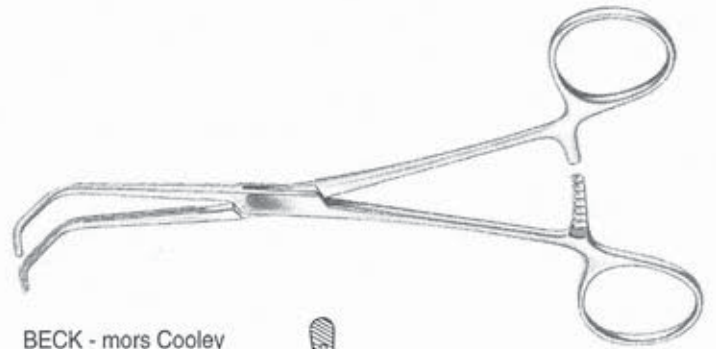
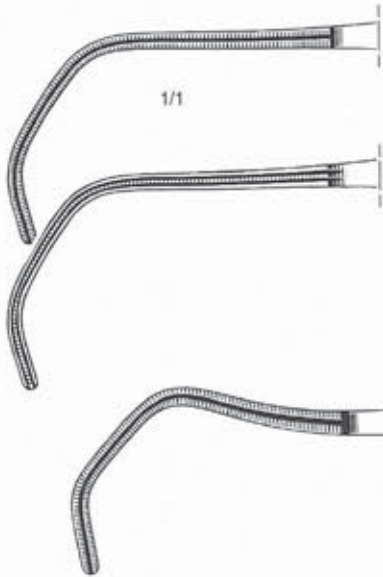

BECK - mors Cooley
CL 098 01 170 mm



BECK - mors De Bakey
CL 098 02 170 mm



COOLEY
CL 098 03 160 mm

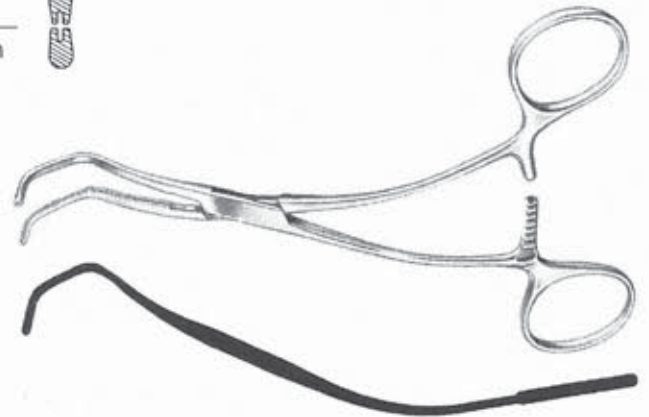

DERRA - mors Cooley

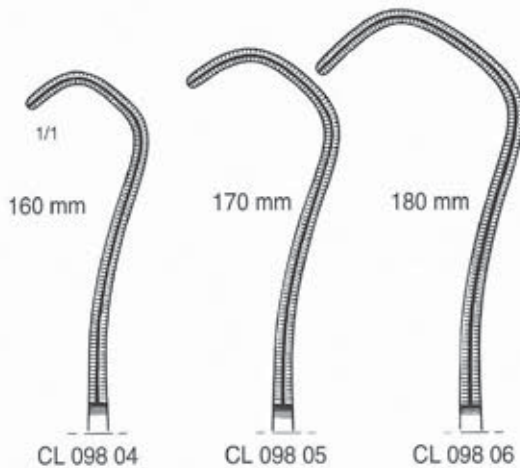

CL 098 04

CL 098 05

CL 098 06

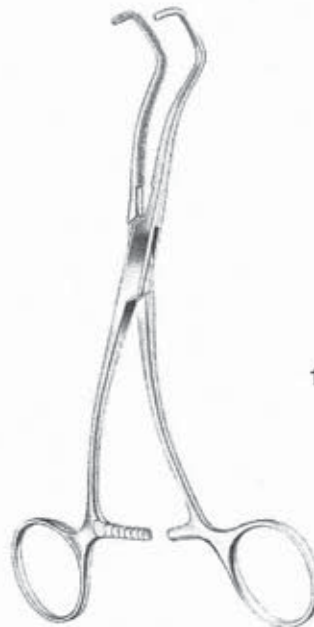

DERRA - mors De Bakey

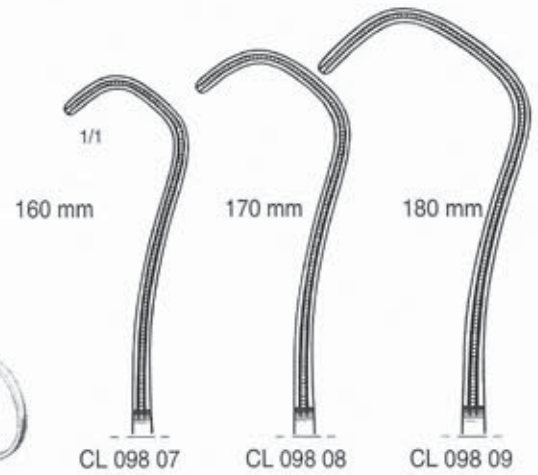

CL 098 07

CL 098 08

CL 098 09



CLAMPS VASCULAIRES

AORTIQUES

DE BAKEY - exclusion

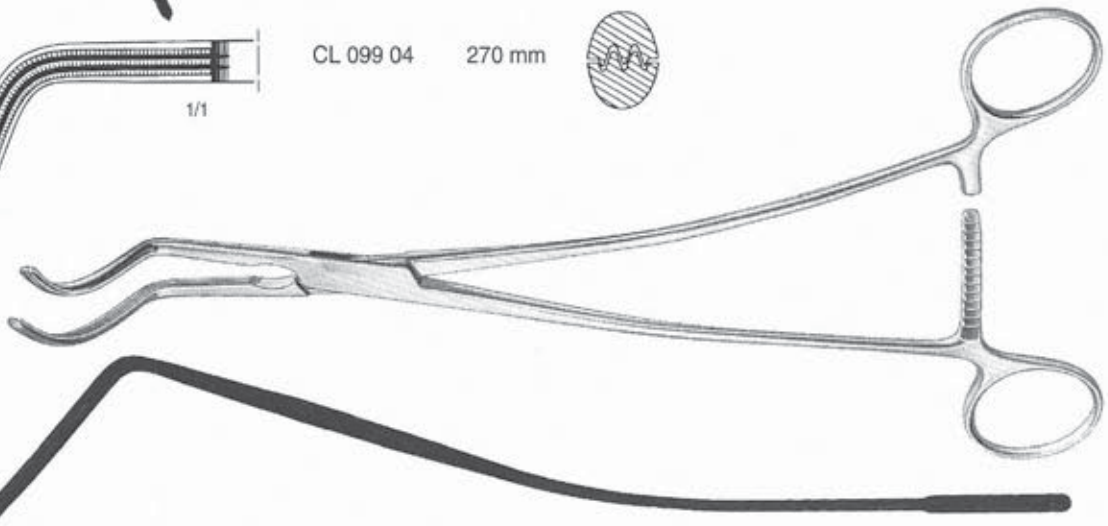
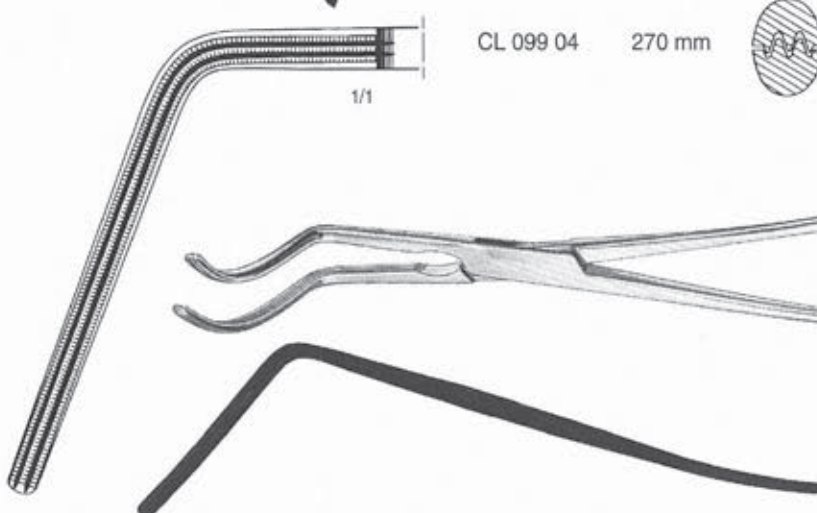
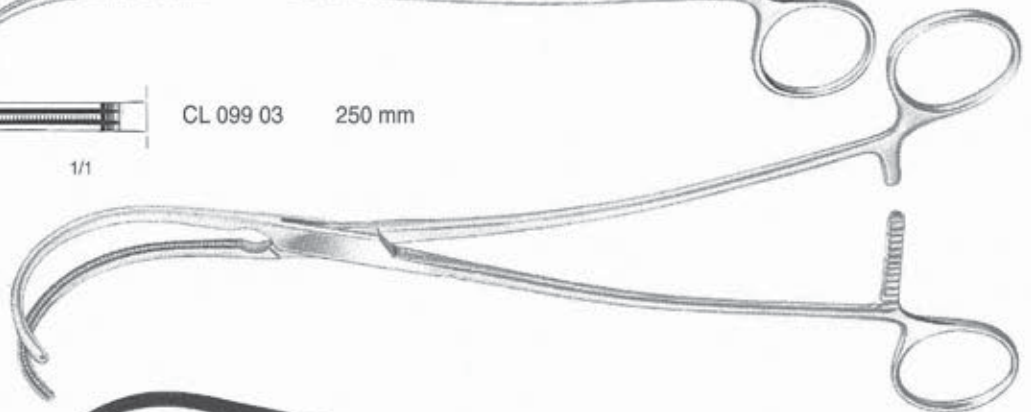
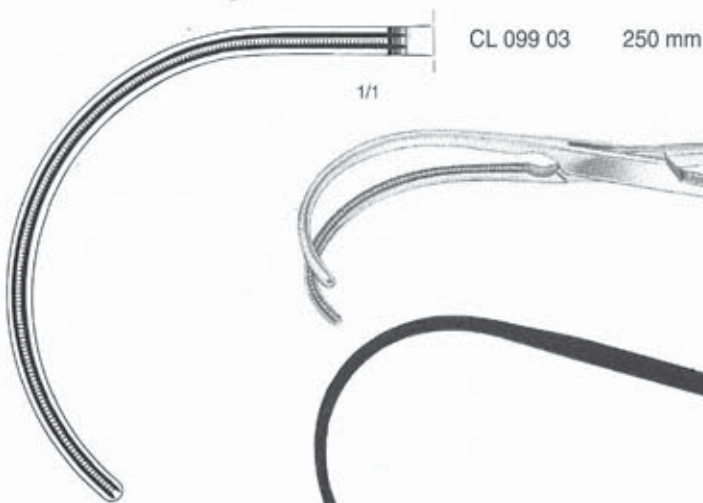
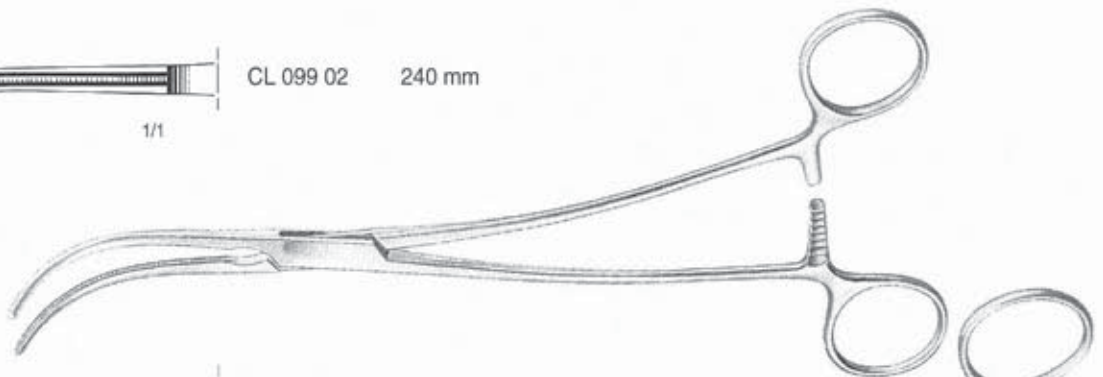
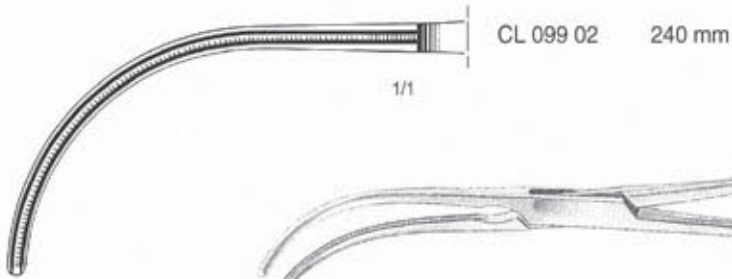
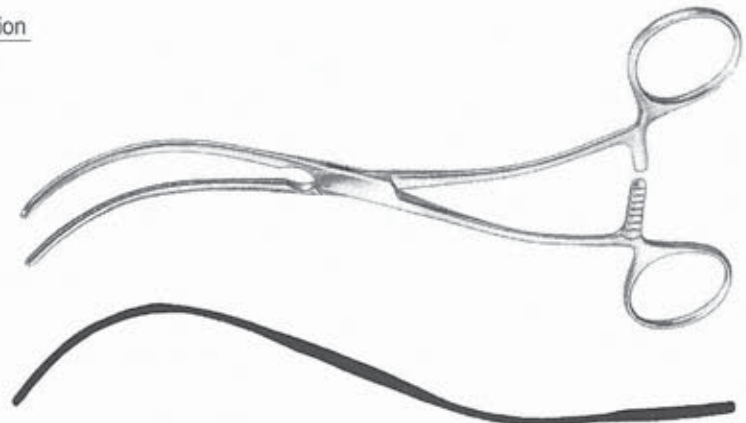
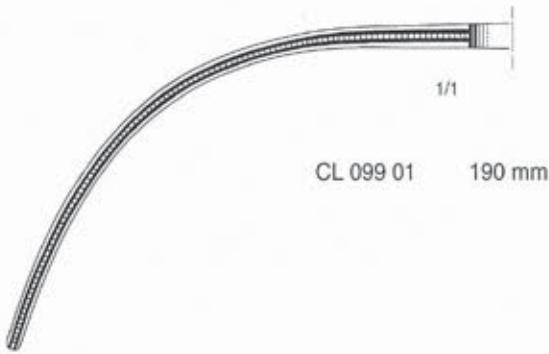



CLAMPS VASCULAIRES AORTIQUES

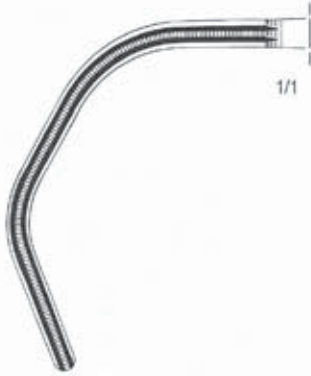

DIETRICH
CL 100 01 210 mm

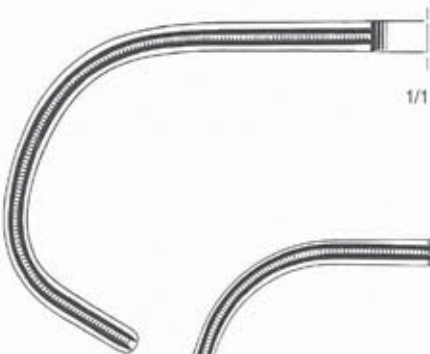
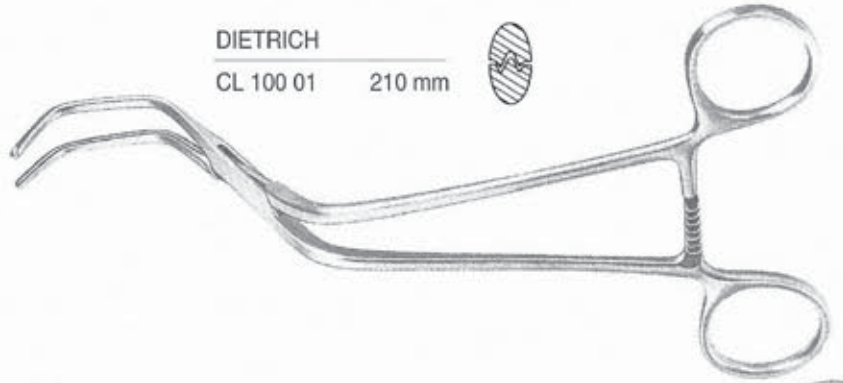

CL 100 02 210 mm

LAMBERT - KAY

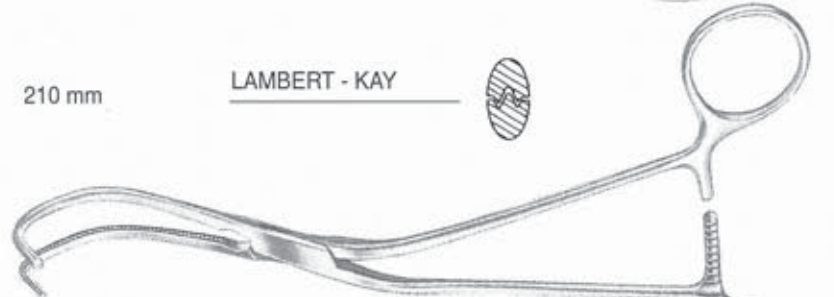

CL 100 03 220 mm

MORRIS

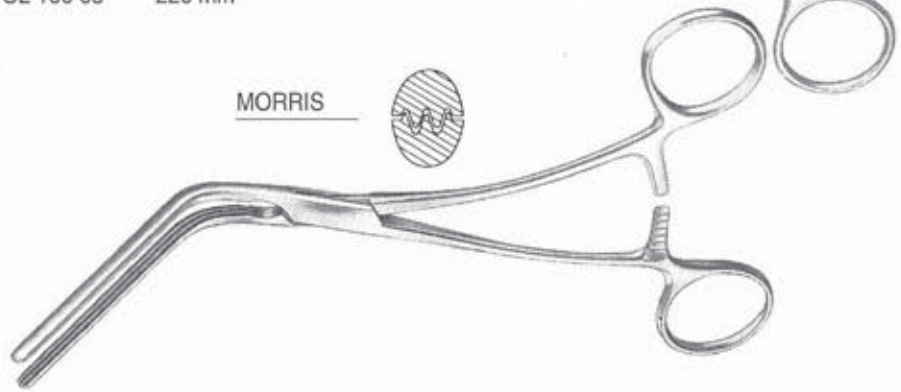

CL 100 04 180 mm

CL 100 05 200 mm

CL 100 06 230 mm

CL 100 07 250 mm





CLAMPS VASCULAIRES

AORTIQUES

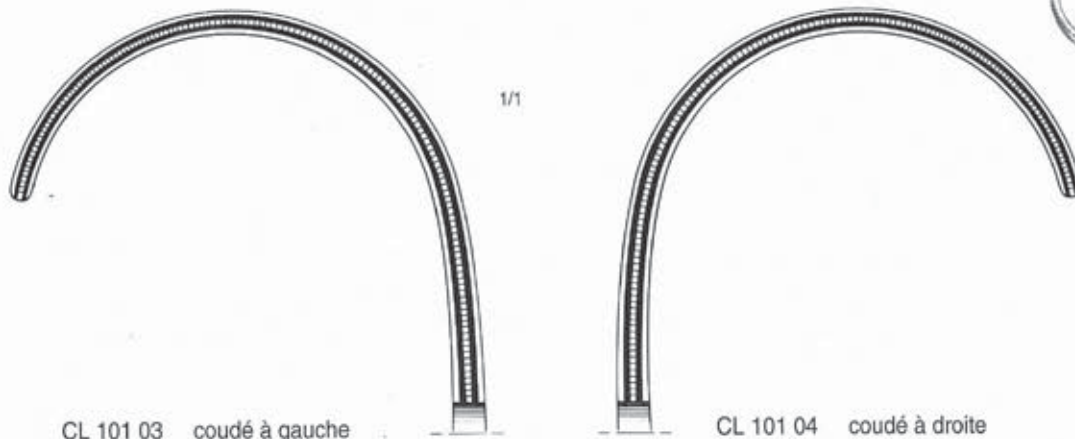
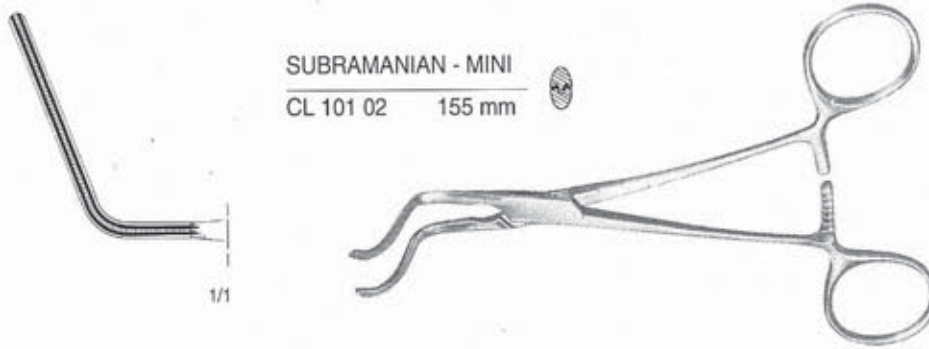
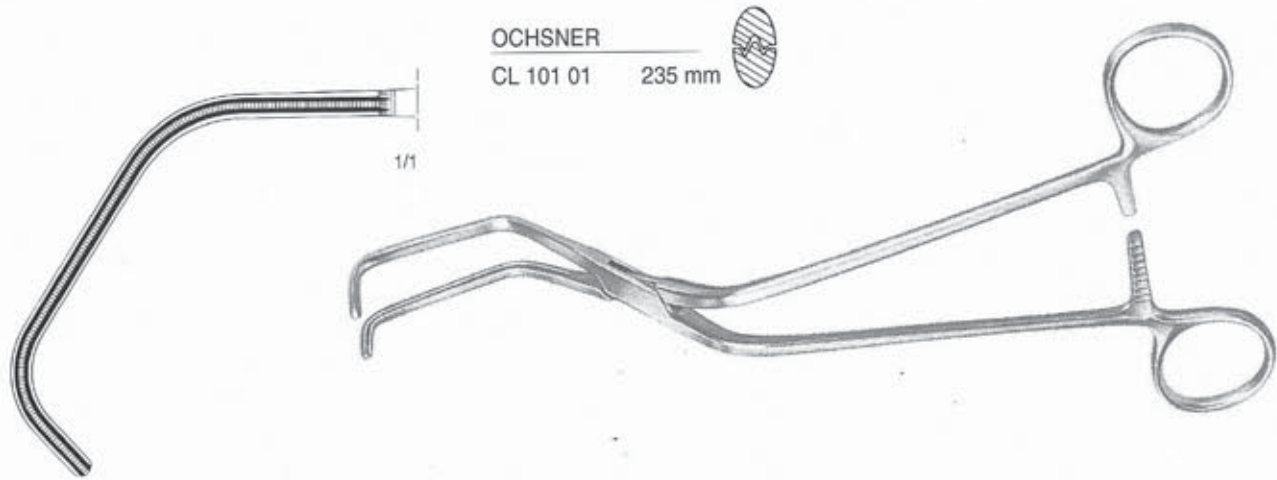

CL 101 03 coudé à gauche

CL 101 04 coudé à droite



CLAMPS VASCULAIRES

AORTIQUES - ANEURISMES

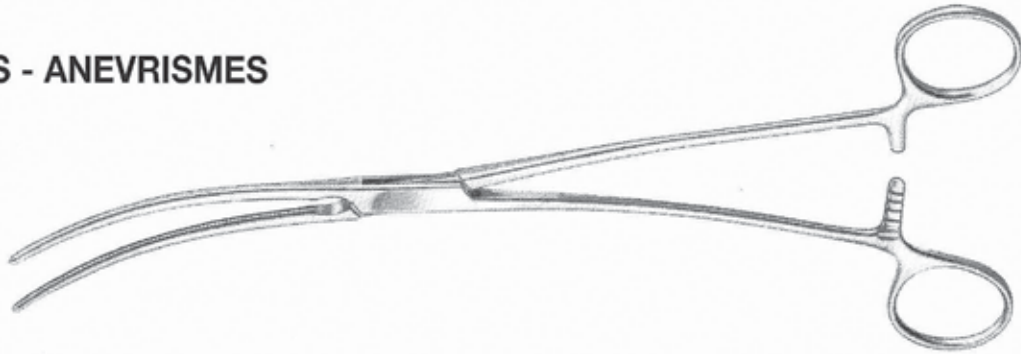

1/1

DE BAKEY

CL 102 01 260 mm

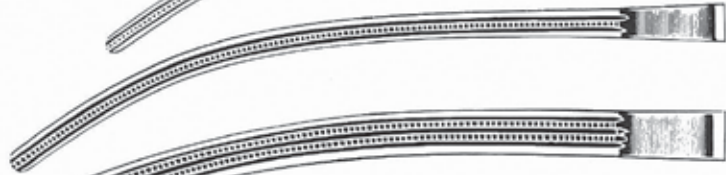

CL 102 02 270 mm



CL 102 03 310 mm

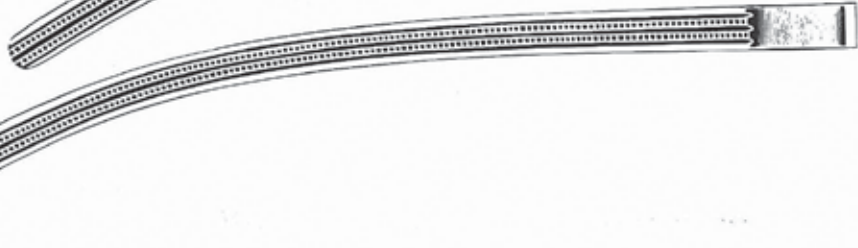

CL 102 04 330 mm

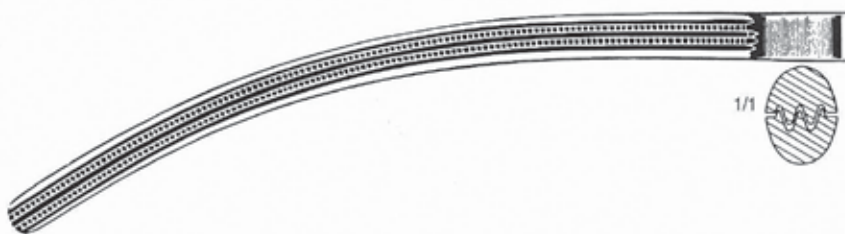
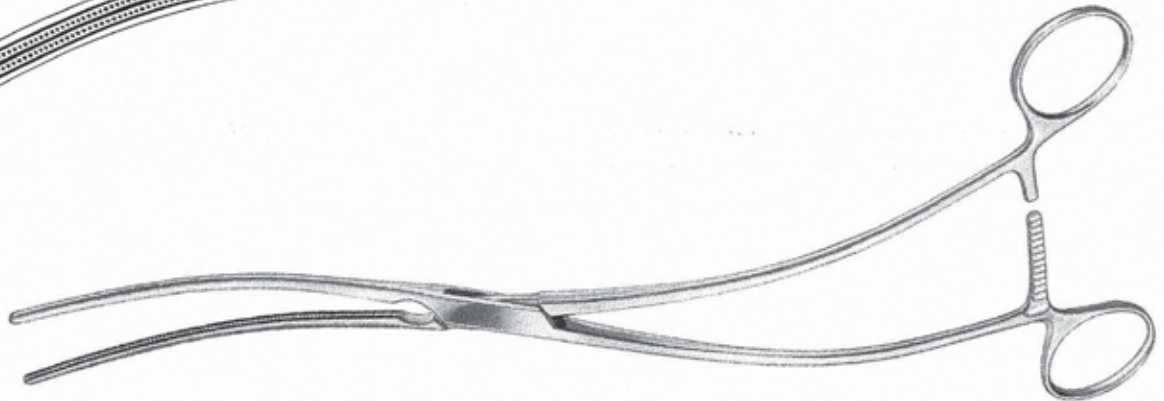

CL 102 05 330 mm en S

1/1

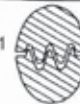



CLAMPS VASCULAIRES

BRONCHES



PRICE THOMAS - 220 mm

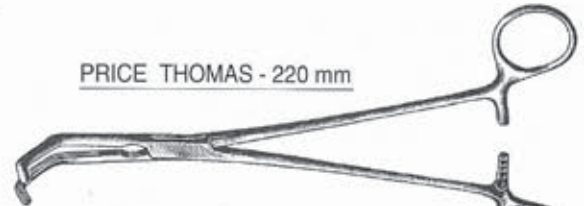

CL 104 01

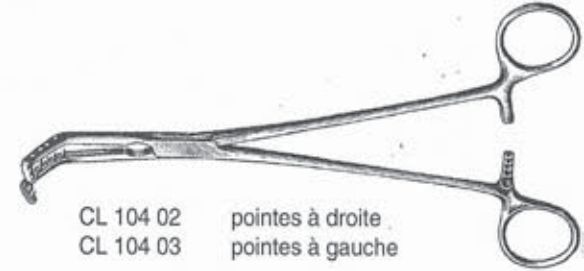

CL 104 02
CL 104 03

pointes à droite
pointes à gauche

SAROT - 230 mm

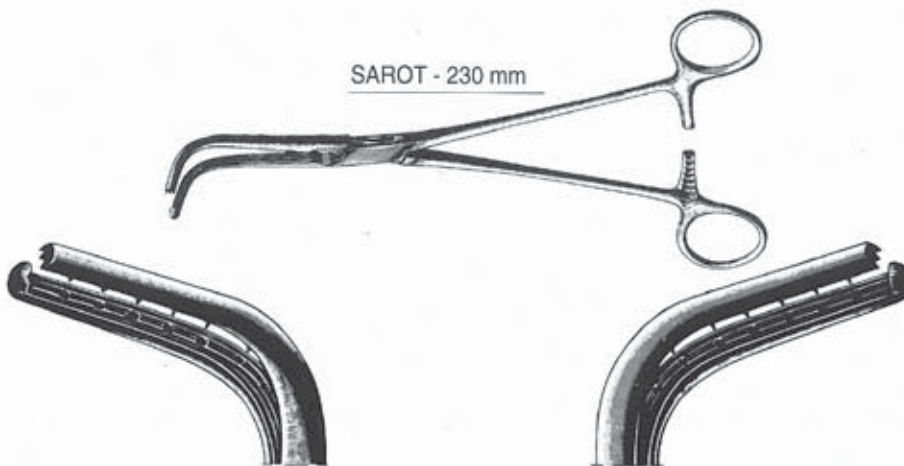

CL 104 04 pointes à gauche

CL 104 05 pointes à droite

BULLDOG

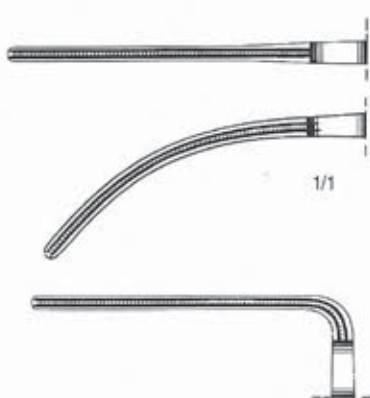

DE BAKEY

CL 104 06 120 mm

CL 104 07 110 mm

CL 104 08 100 mm

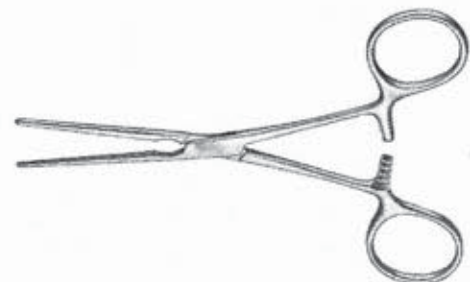



CLAMPS VASCULAIRES

BULLDOG



CL 105 01

120 mm

DE BAKEY

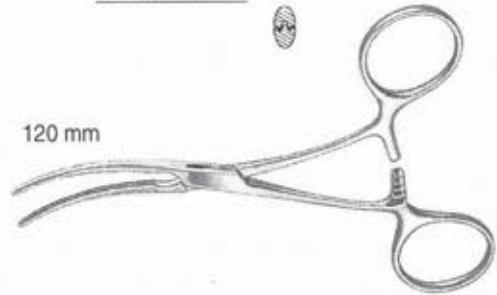

CL 105 02

130 mm

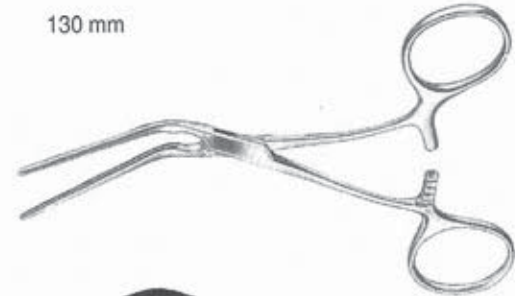

CAROTIDES

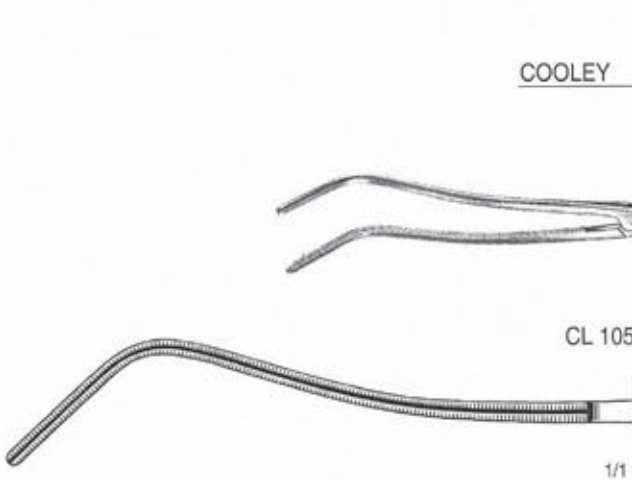

CL 105 03

200 mm

COOLEY

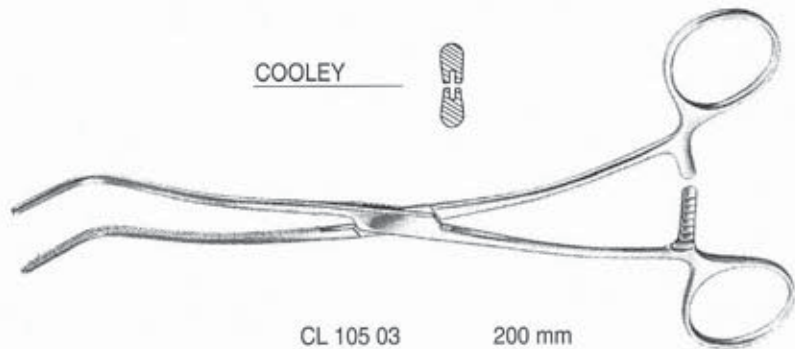



CLAMPS VASCULAIRES

CAROTIDES

JAVID - Pour shunt



CL 106 01 180 mm

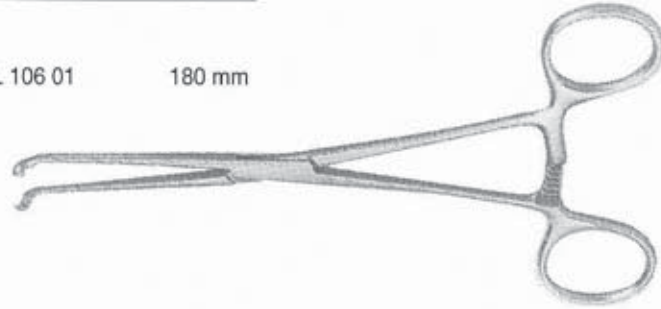

CL 106 02 190 mm

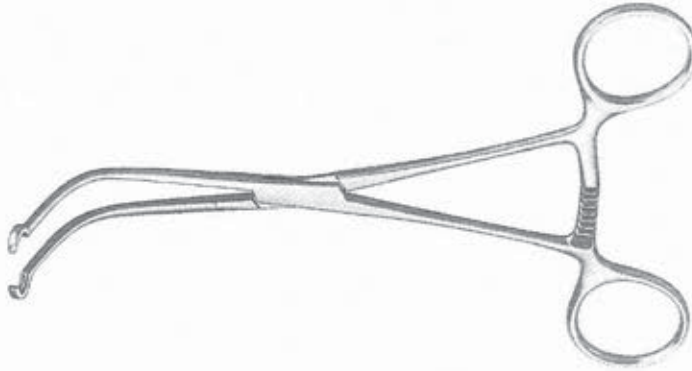

COARCTATION



COOLEY - 170 mm



CL 106 03

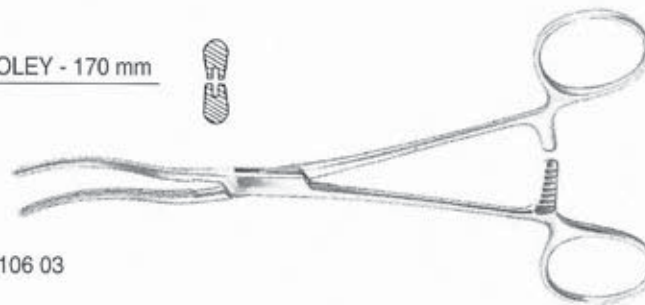

CL 106 04

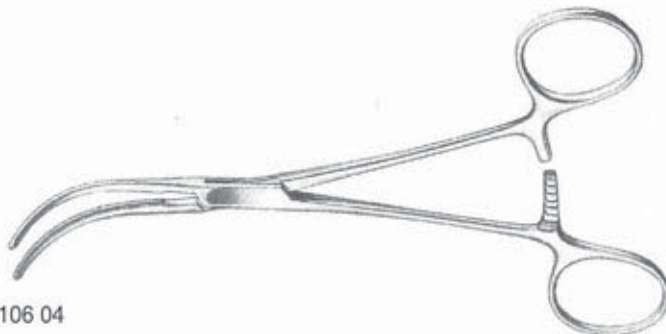



CLAMPS VASCULAIRES

COARCTATION



COOLEY - 170 mm

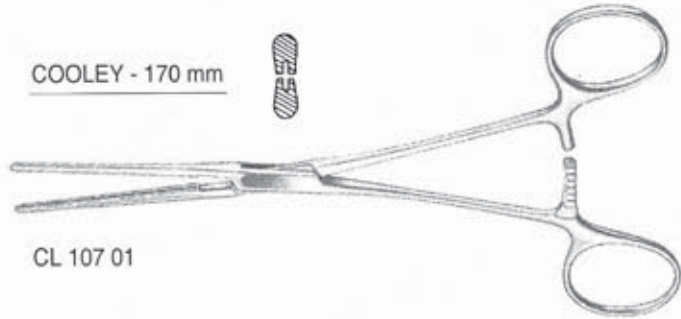

CL 107 01

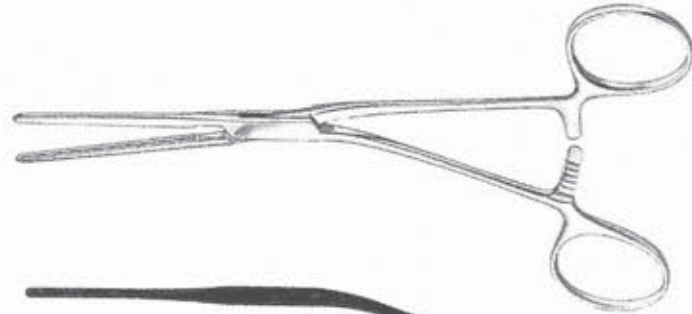

CL 107 02

DE BAKEY - 170 mm

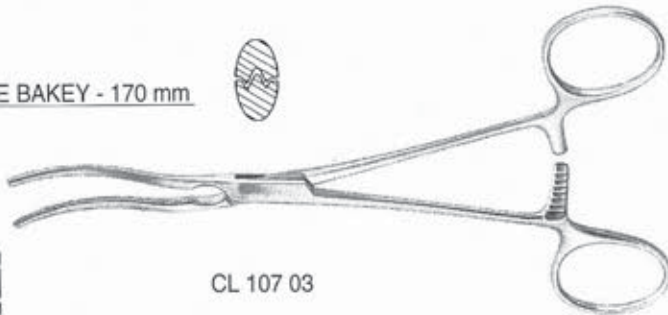

CL 107 03

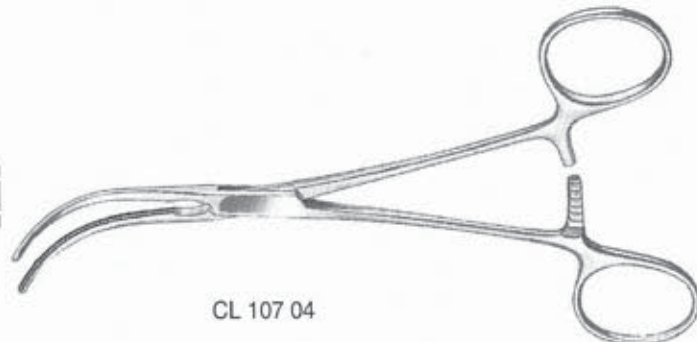

CL 107 04



CLAMPS VASCULAIRES

COARCTATION

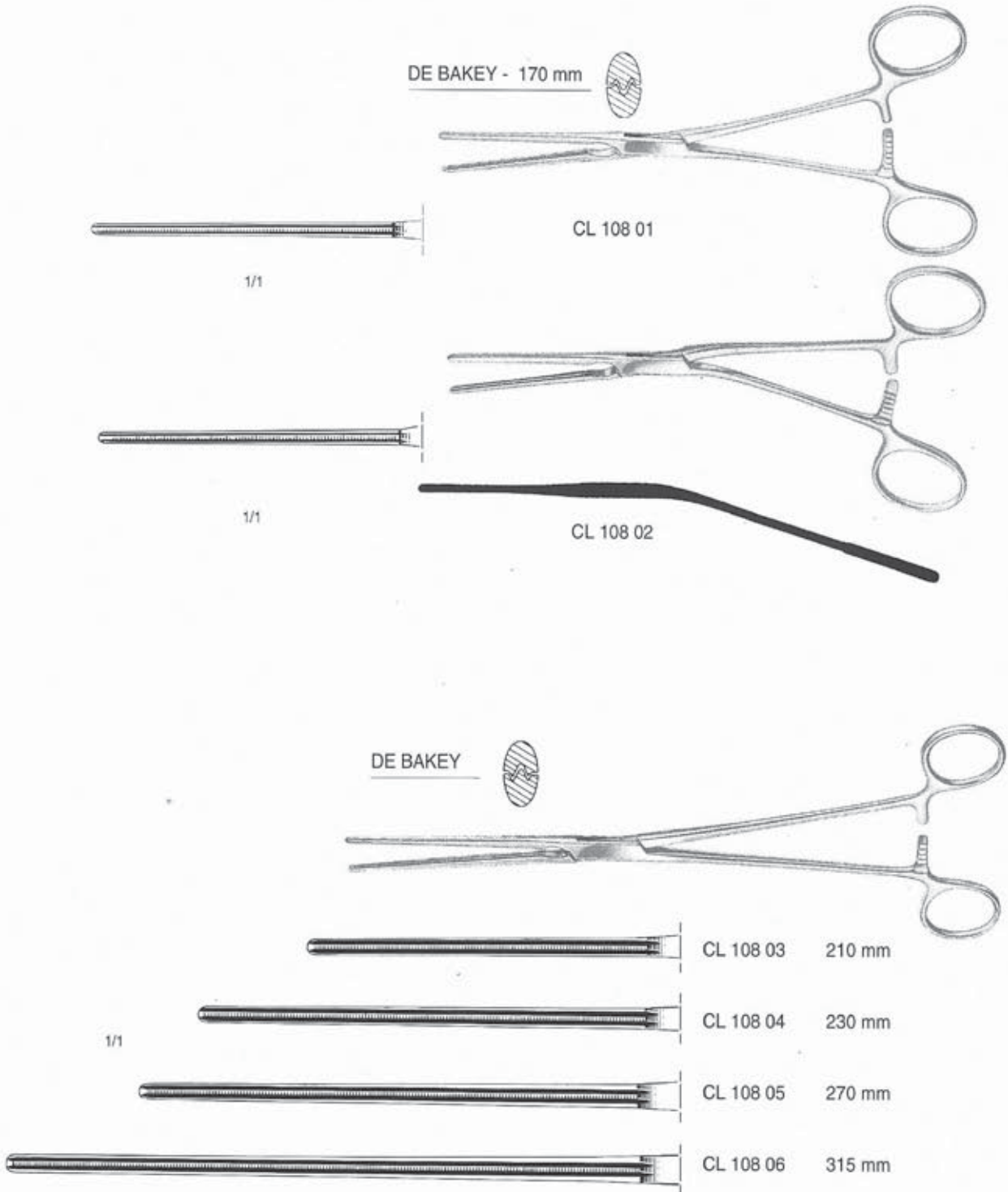



CLAMPS VASCULAIRES

COARCTATION

DE BAKEY

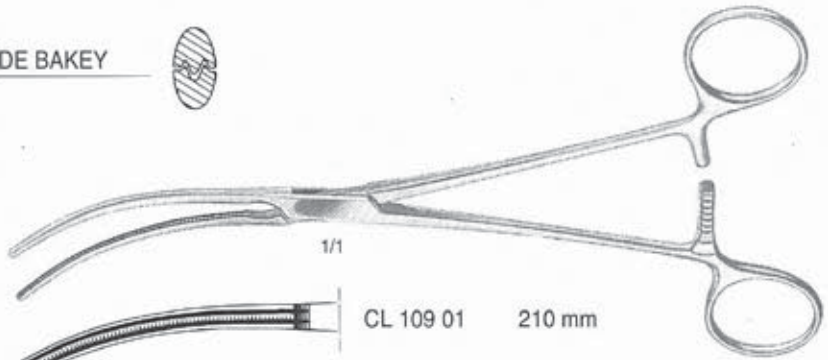

1/1

CL 109 01 210 mm



CL 109 02 230 mm



CL 109 03 270 mm



CL 109 04 315 mm

GLOVER DE BAKEY

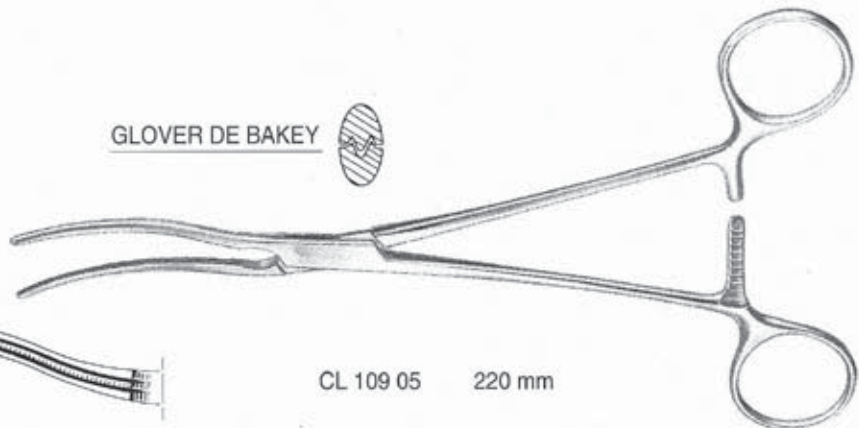

CL 109 05 220 mm



1/1

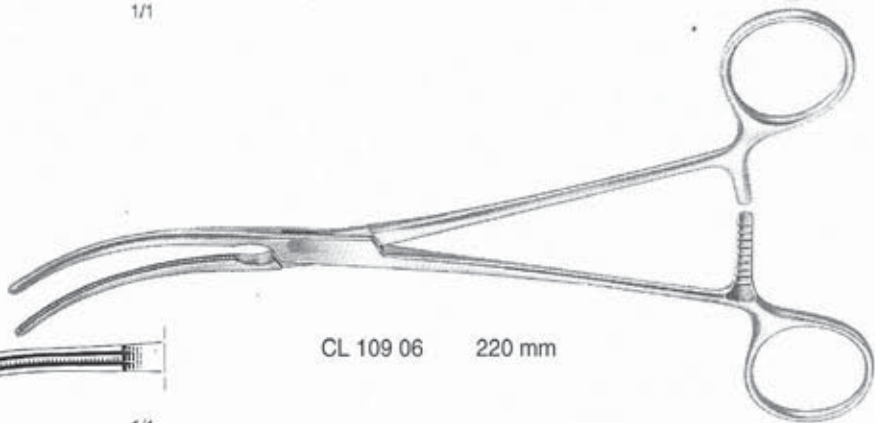

CL 109 06 220 mm



1/1



CLAMPS VASCULAIRES

COARCTATION

GLOVER DE BAKEY

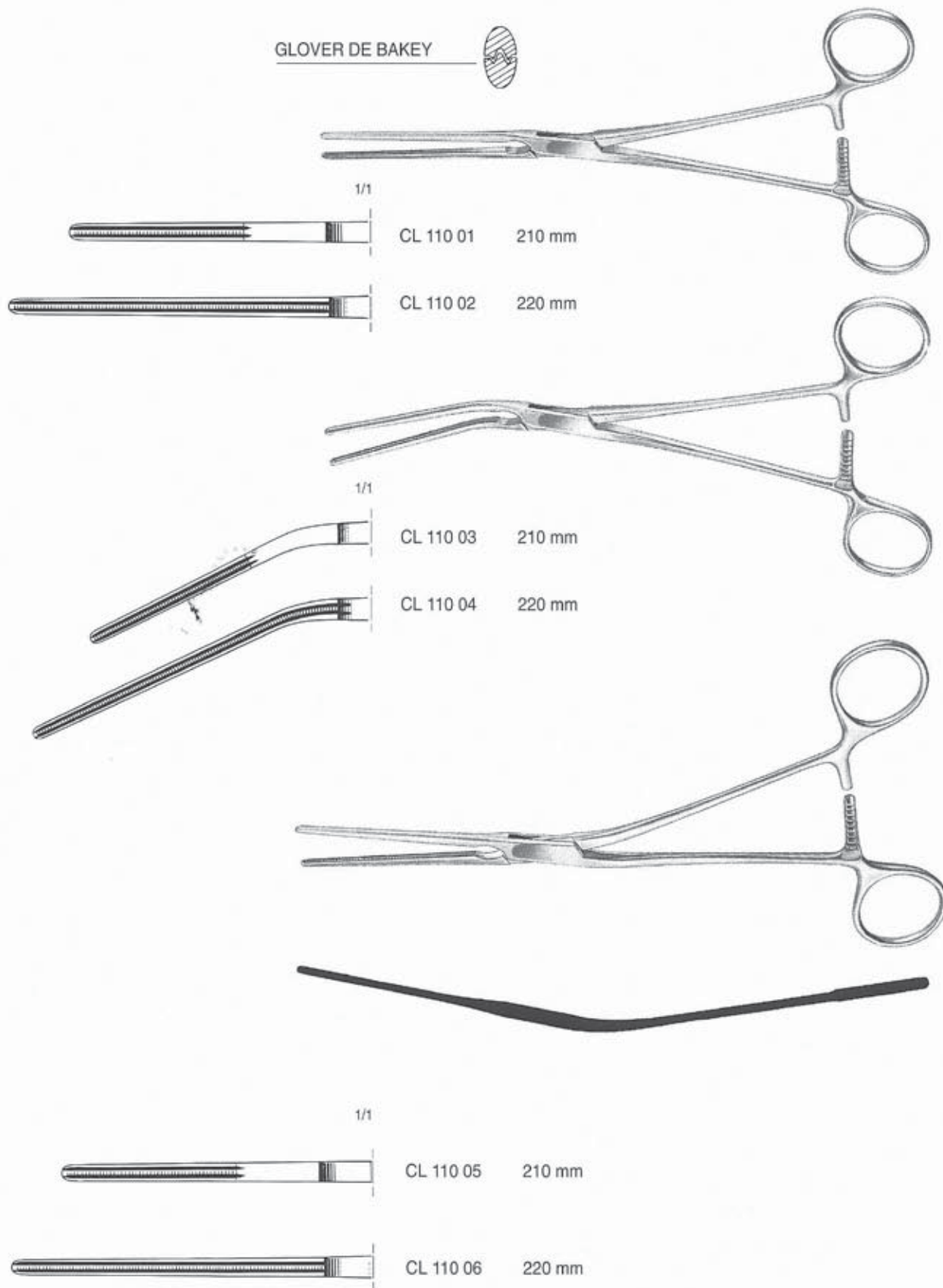



CLAMPS VASCULAIRES

ILIAQUE

DE BAKEY - BAHNSON

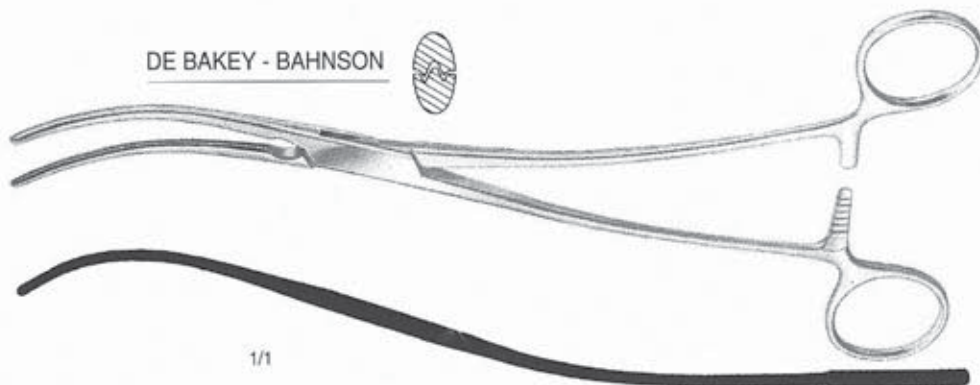

CL 111 01 250 mm



CL 111 02 240 mm



CL 111 03 230 mm

LIGATURES - DISSECTIONS

DE BAKEY

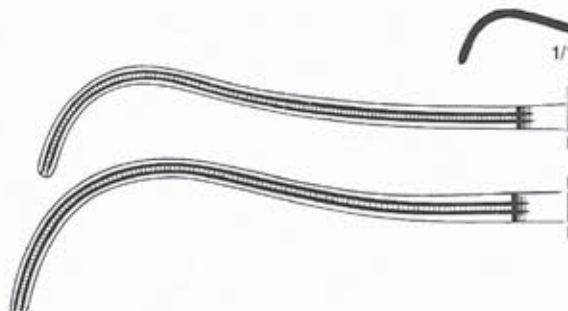
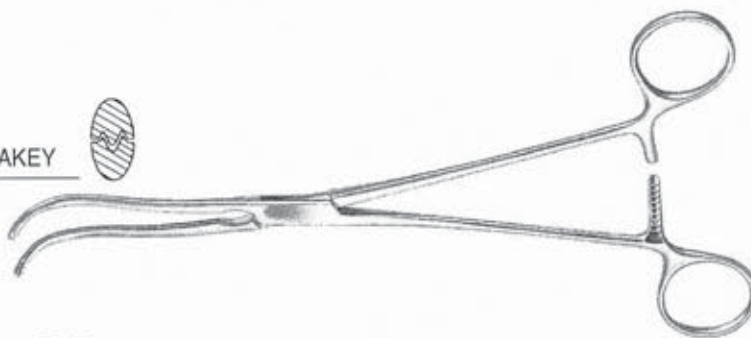

CL 111 04 190 mm



CL 111 05 230 mm



CLAMPS VASCULAIRES

LIGATURES - DISSECTIONS

DE BAKEY - SEMB

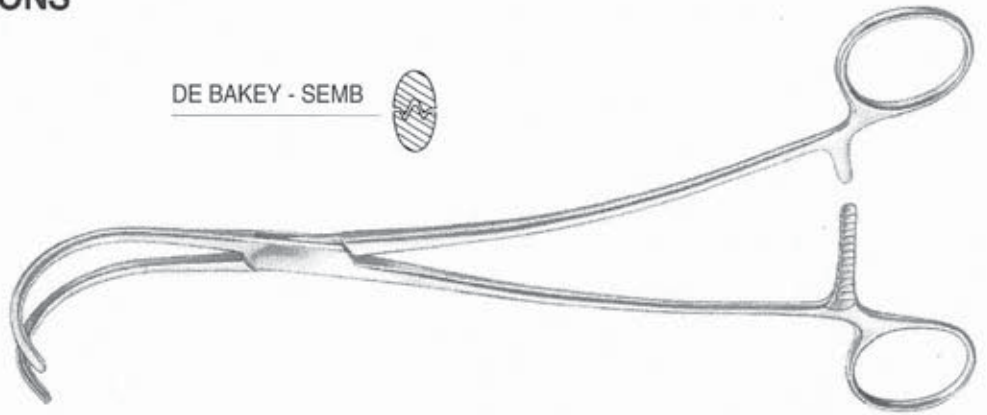

CL 112 02 250 mm

MULTIPOSE

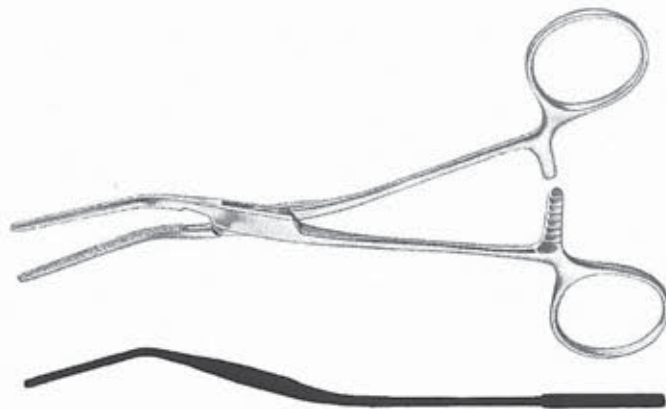

1/1



CL 112 03 mors Cooley 160 mm



CL 112 04 mors De Bakey 160 mm



CLAMPS VASCULAIRES

MULTIPOSE



CL 113 01 mors Cooley 150 mm



CL 113 02 mors De Bakey 150 mm

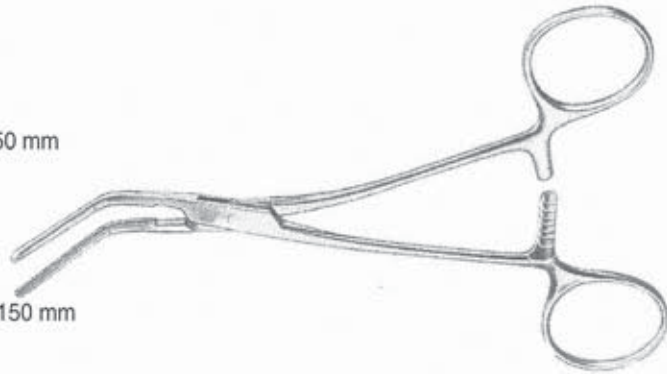

CL 113 03 mors Cooley 150 mm



CL 113 04 mors De Bakey 150 mm

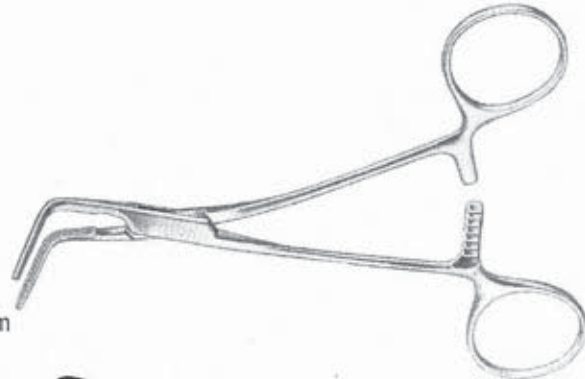

1/1

DE BAKEY

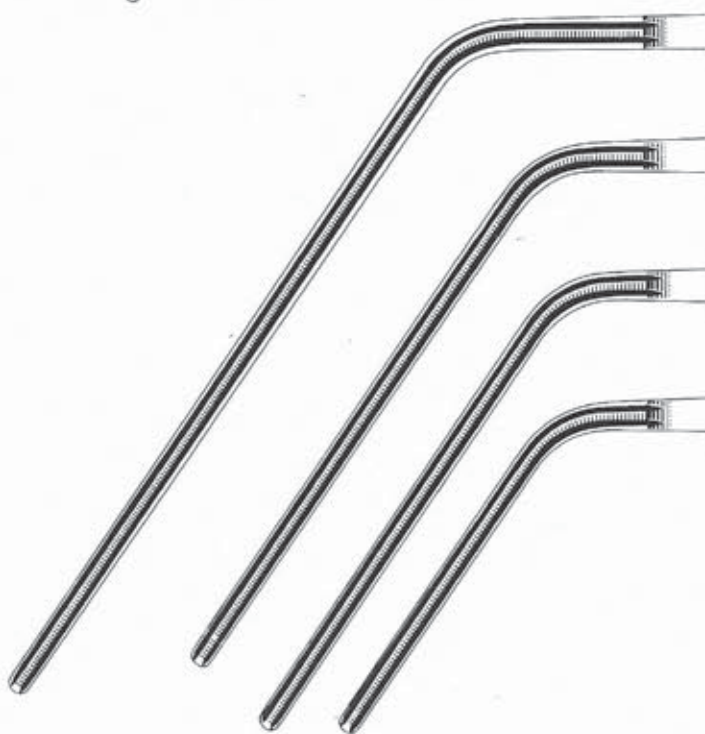

CL 113 05 290 mm

CL 113 06 250 mm

CL 113 07 210 mm

CL 113 08 200 mm

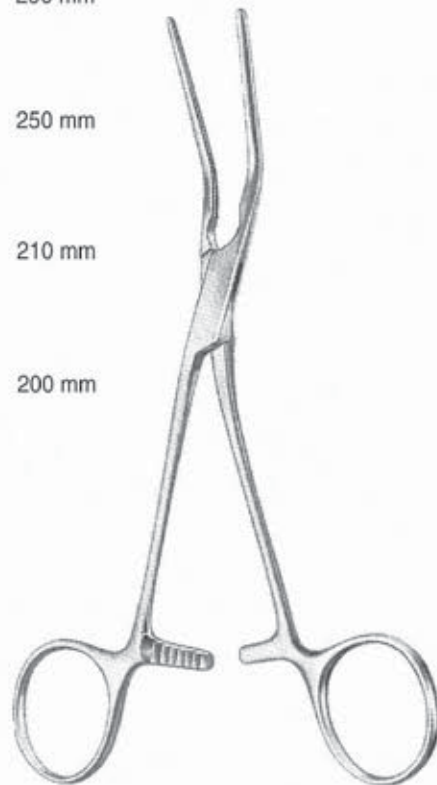



CLAMPS VASCULAIRES

MULTIPOSE

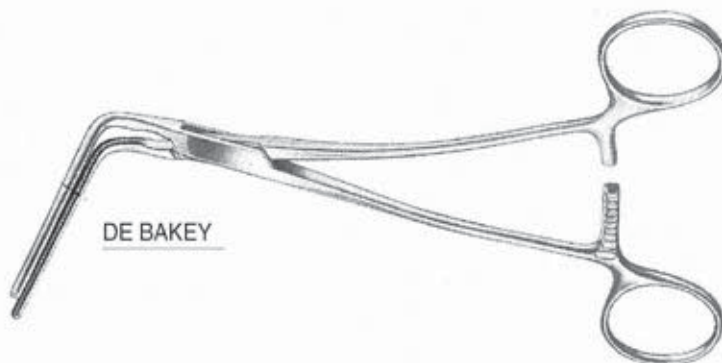

DE BAKEY

CL 114 01 270 mm

CL 114 02 230 mm

CL 114 03 190 mm

CL 114 04 180 mm

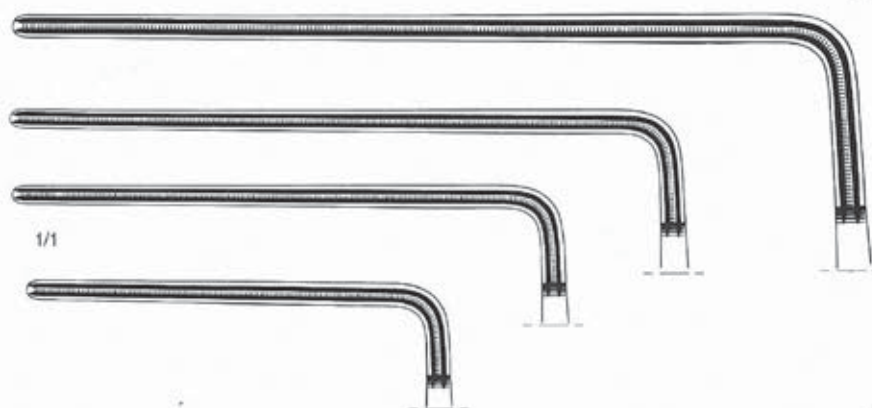

OCCLUSION TANGENTIELLE

SATINSKY - DE BAKEY

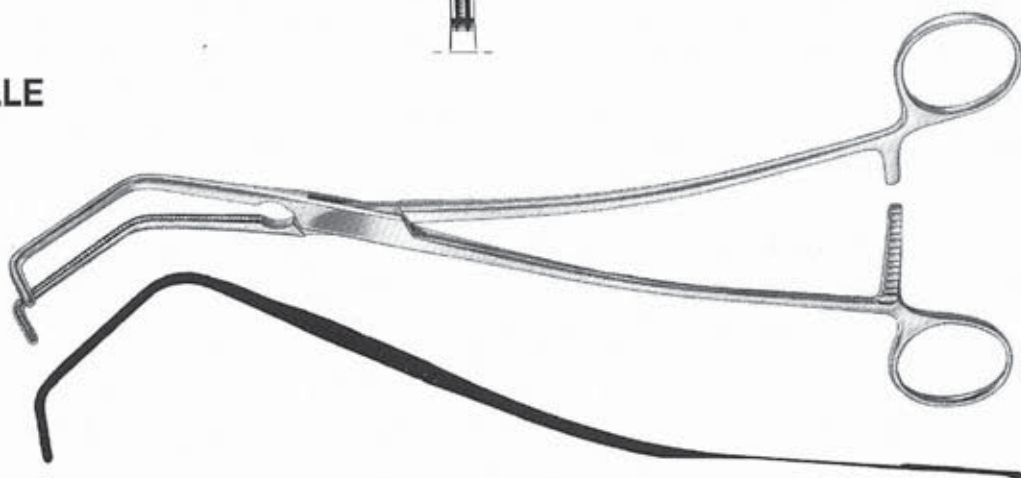

1/1

CL 114 05 280 mm

CL 114 06 270 mm

CL 114 07 260 mm

CL 114 08 250 mm

CL 114 09 200 mm

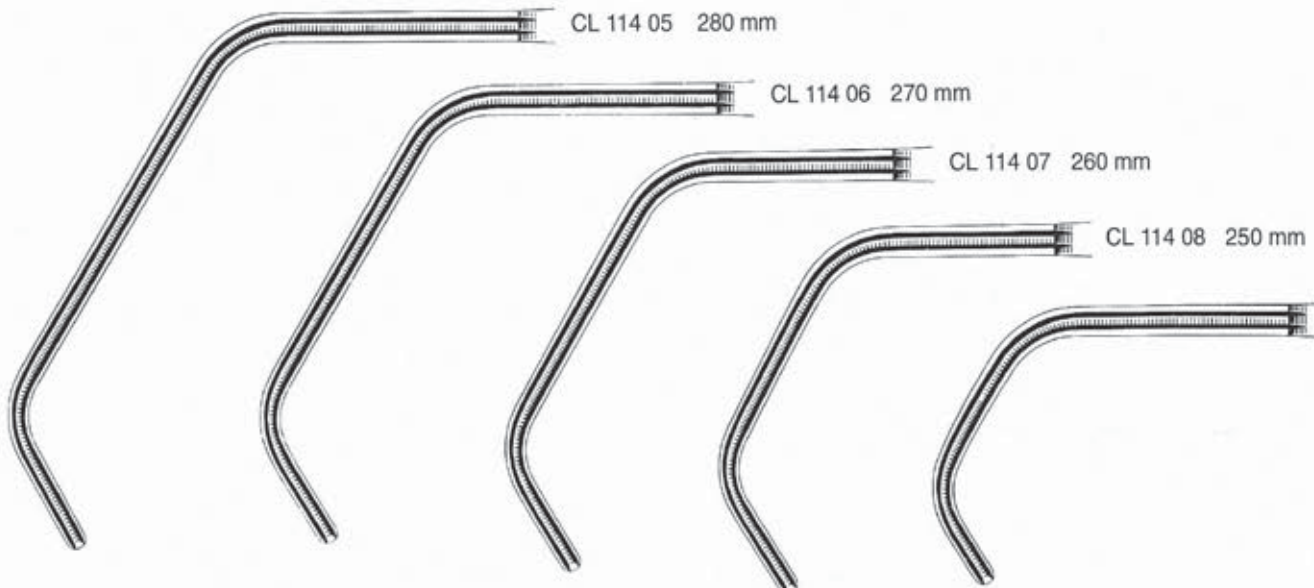





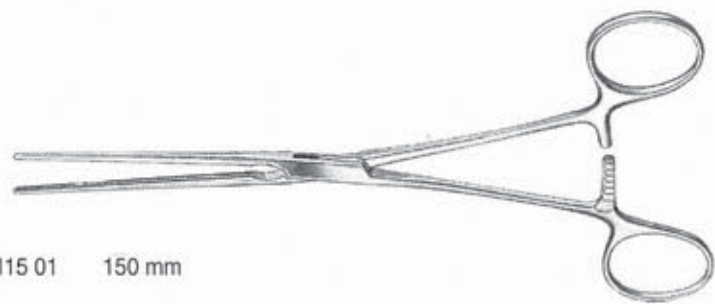

CLAMPS VASCULAIRES

PERIPHERIQUES



BAINBRIDGE 



- | | | |
|--|-----------|--------|
|  | CL 115 01 | 150 mm |
|  | CL 115 02 | 180 mm |
|  | CL 115 03 | 150 mm |
|  | CL 115 04 | 180 mm |

COOLEY



- | | | |
|---|-----------|--------|
|  | CL 115 05 | 170 mm |
|  | CL 115 06 | 160 mm |

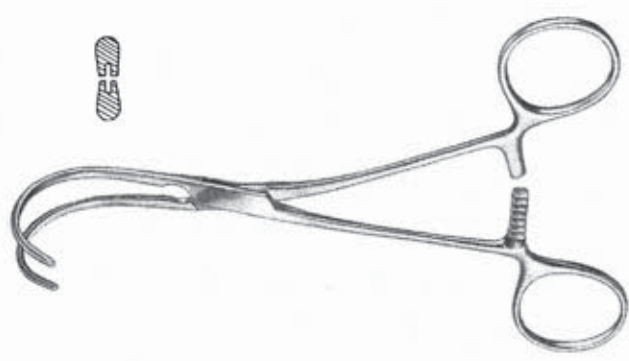

DALLE - Fémorale - Poplitée 

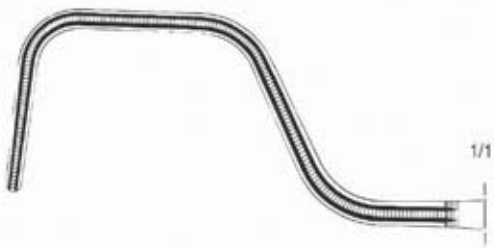

CL 115 07 185 mm

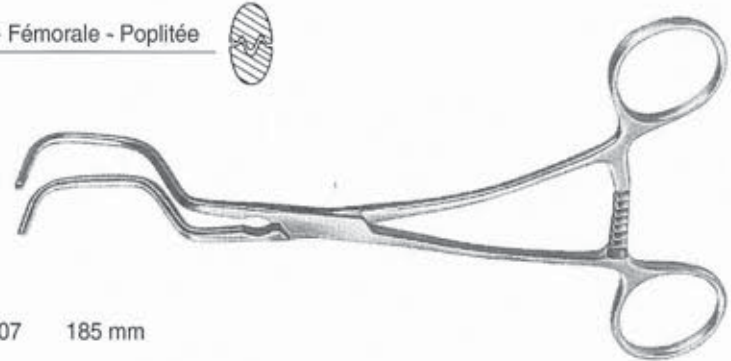



CLAMPS VASCULAIRES

PERIPHERIQUES

DALE - Fémorale - Poplitée

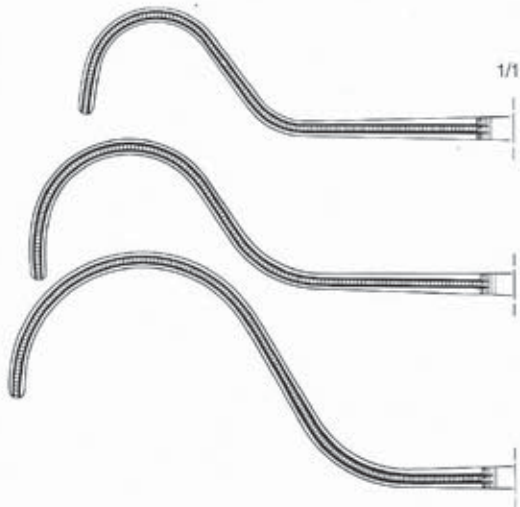

CL 116 01

170 mm

CL 116 02

175 mm

CL 116 03

185 mm

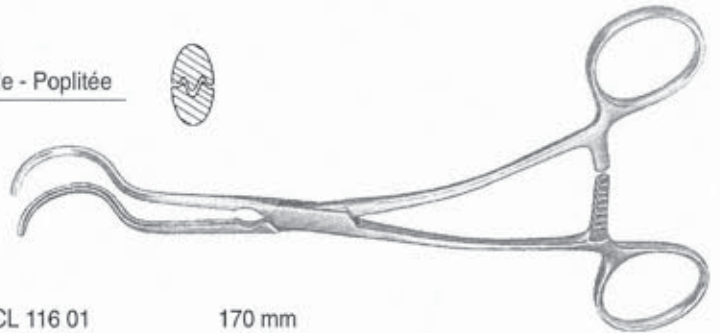

DE BAKEY



CL 116 04

160 mm

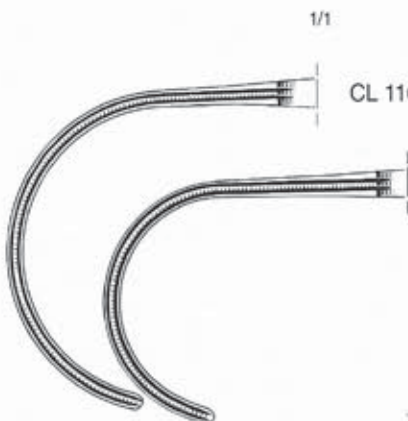
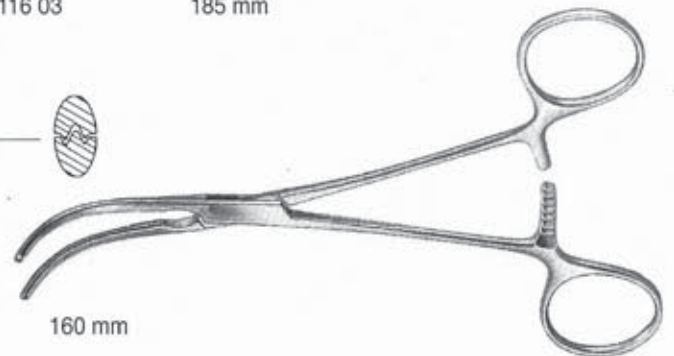

CL 116 05 170 mm

CL 116 06 160 mm

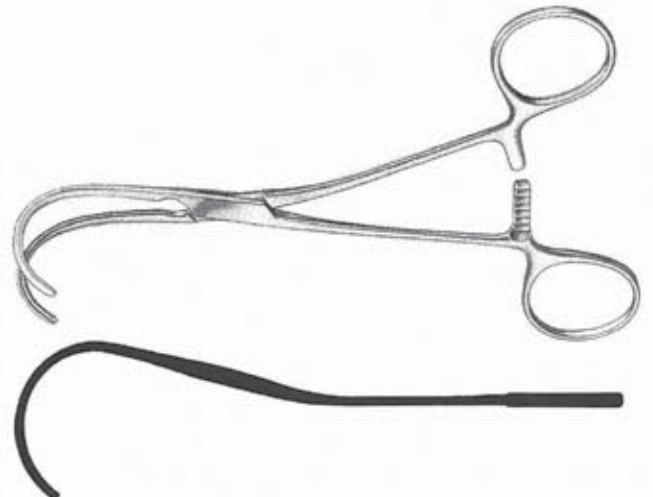



CLAMPS VASCULAIRES

PERIPHERIQUES



DE BAKEY - carotide - sous clavière
- fémorale - poplitée

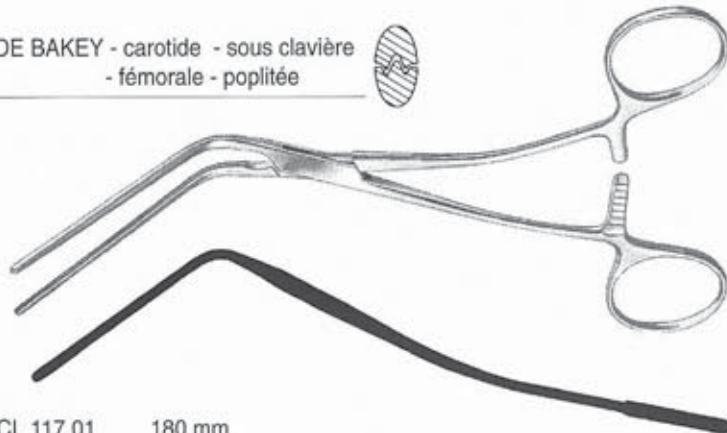

CL 117 01 180 mm

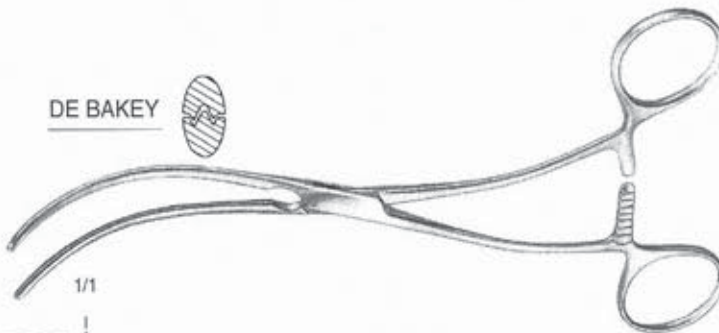

DE BAKEY

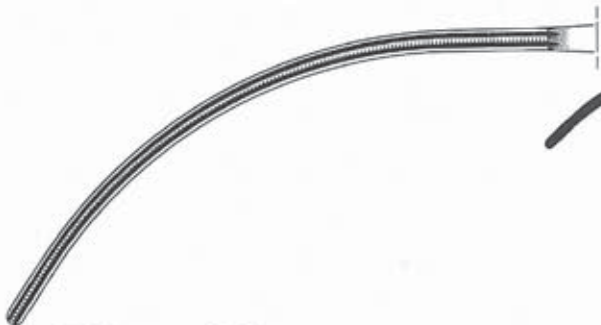

1/1



CL 117 02 200 mm

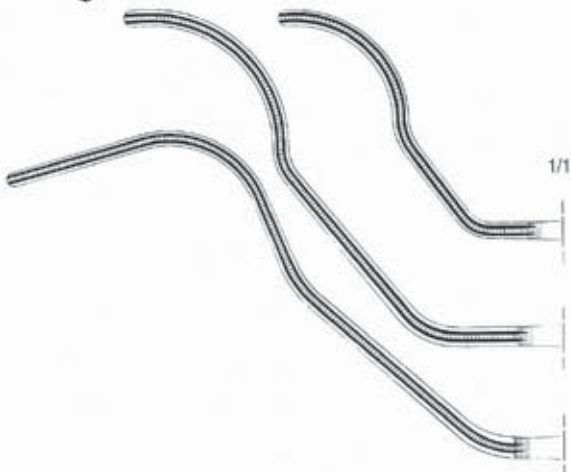

1/1

GREGORY



CL 117 03 140 mm

CL 117 04 160 mm

CL 117 05 180 mm

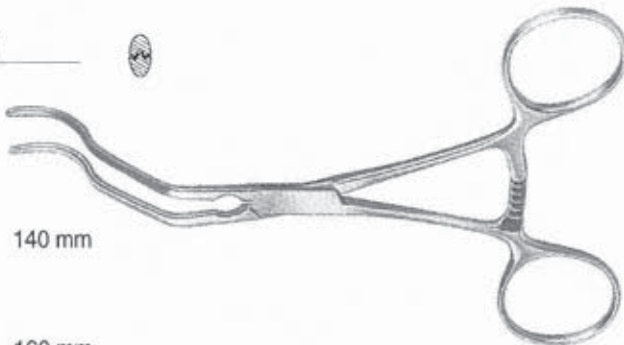



CLAMPS VASCULAIRES PERIPHERIQUES

LELAND - JONES - carotide - sous clavière
- fémorale - poplitée

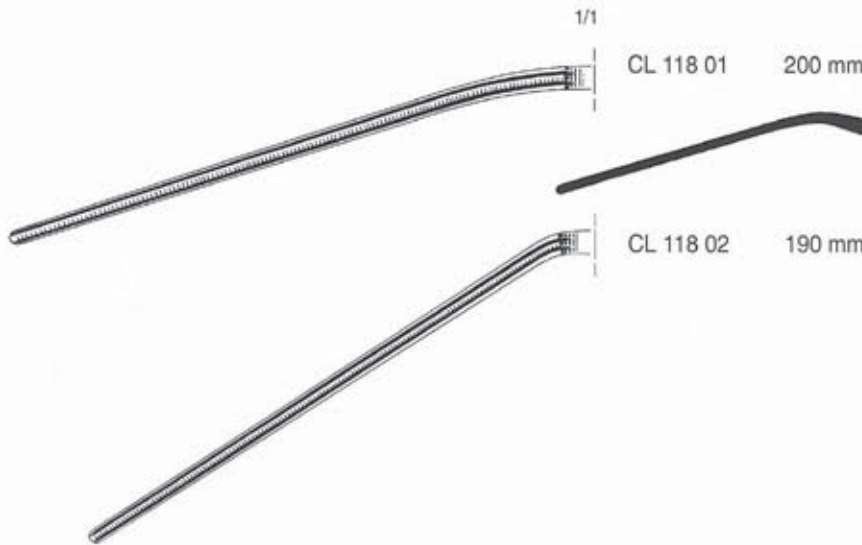
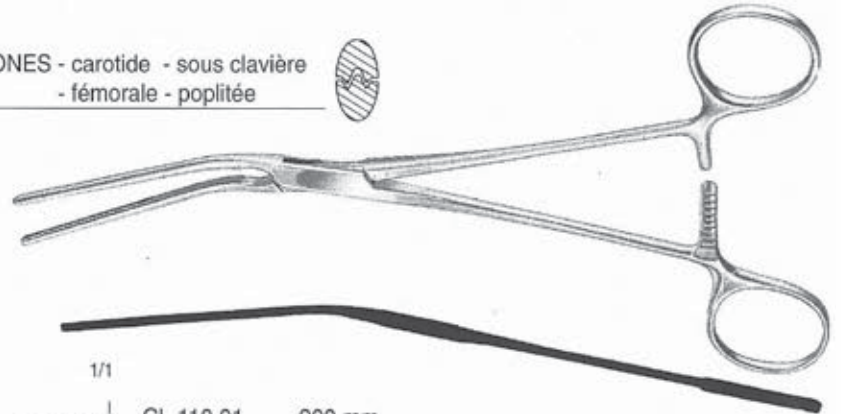

PEDIATRIQUES

CASTANEDA

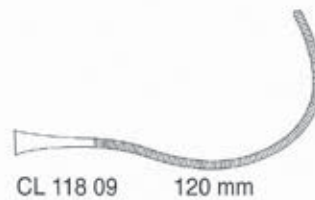
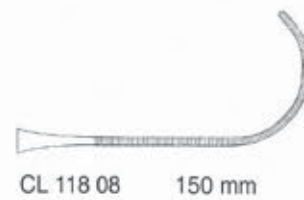
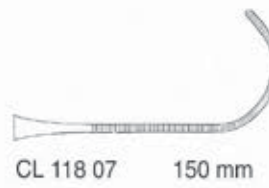
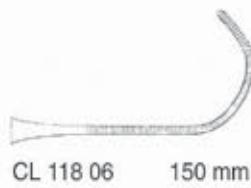
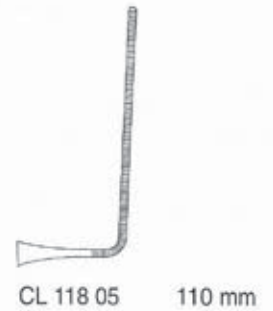
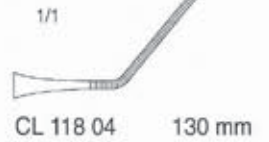
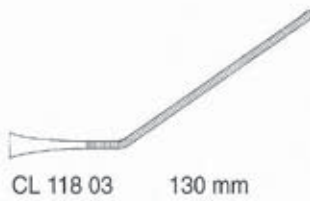
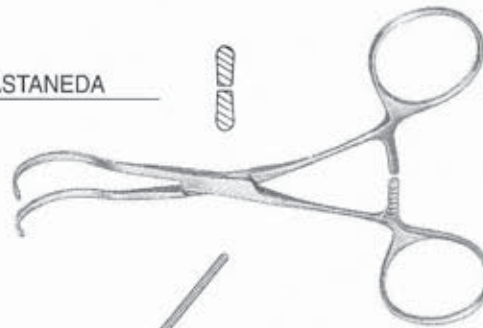



CLAMPS VASCULAIRES

PEDIATRIQUES

COOLEY - modèle - Fin

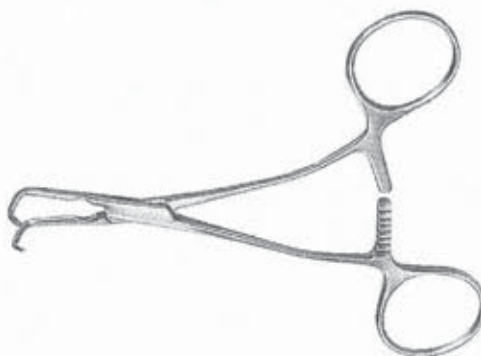

1/1

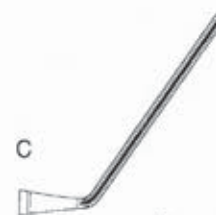

DROIT

CL 119 01	A	145 mm
CL 119 02	B	145 mm
CL 119 03	C	135 mm
CL 119 04	D	145 mm
CL 119 05	E	140 mm
CL 119 06	F	135 mm
CL 119 07	G	135 mm
CL 119 08	H	140 mm
CL 119 09	J	135 mm

FAIBLE ANGULATION

CL 119 10	A	145 mm
CL 119 11	B	145 mm
CL 119 12	C	135 mm
CL 119 13	D	145 mm
CL 119 14	E	140 mm
CL 119 15	F	135 mm
CL 119 16	G	135 mm
CL 119 17	H	140 mm
CL 119 18	J	135 mm

FORTE ANGULATION

CL 119 19	A	145 mm
CL 119 20	B	145 mm
CL 119 21	C	135 mm
CL 119 22	D	145 mm
CL 119 23	E	140 mm
CL 119 24	F	135 mm
CL 119 25	G	135 mm
CL 119 26	H	140 mm
CL 119 27	J	135 mm



CLAMPS VASCULAIRES

PEDIATRIQUES

COOLEY

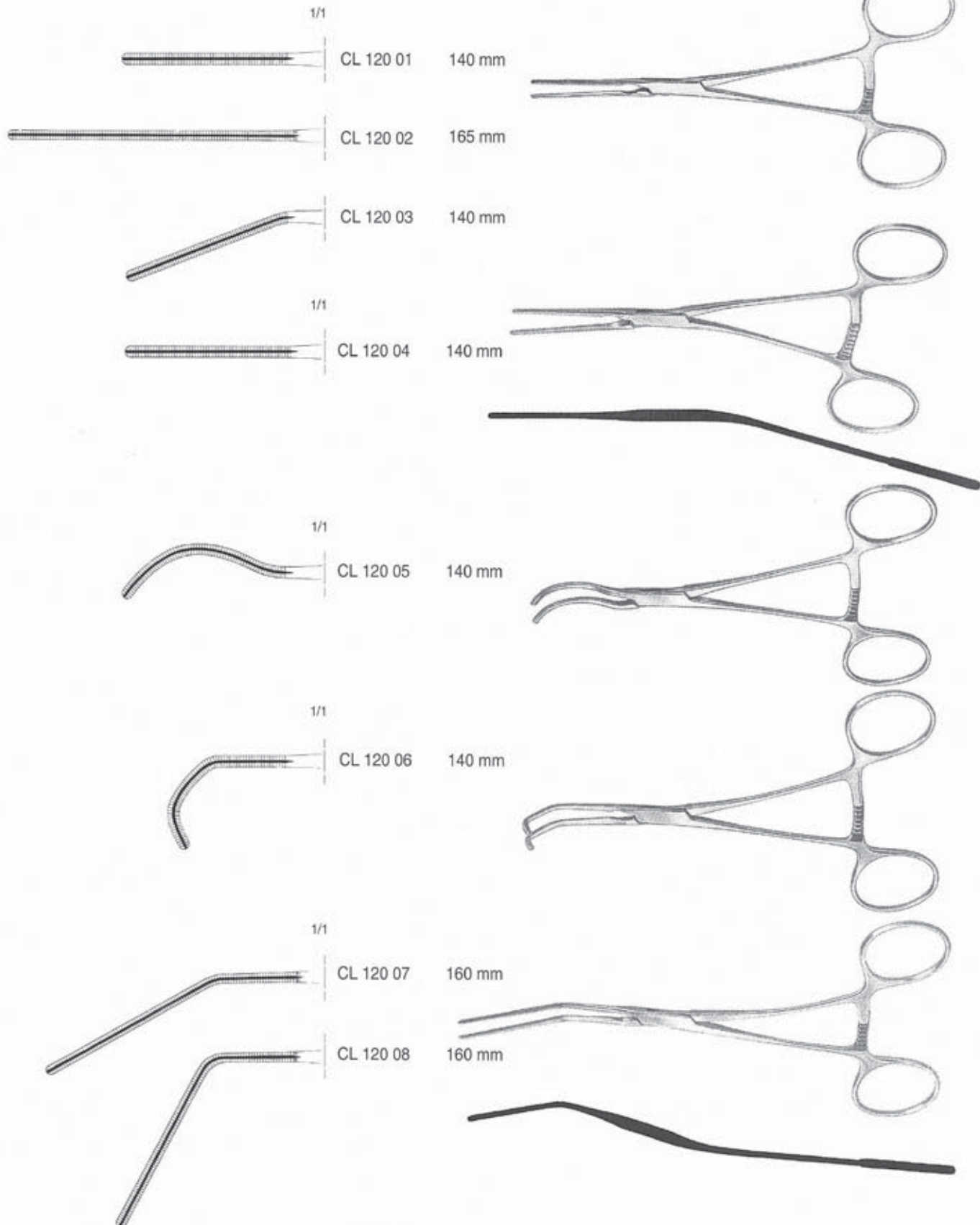



CLAMPS VASCULAIRES

PEDIATRIQUES

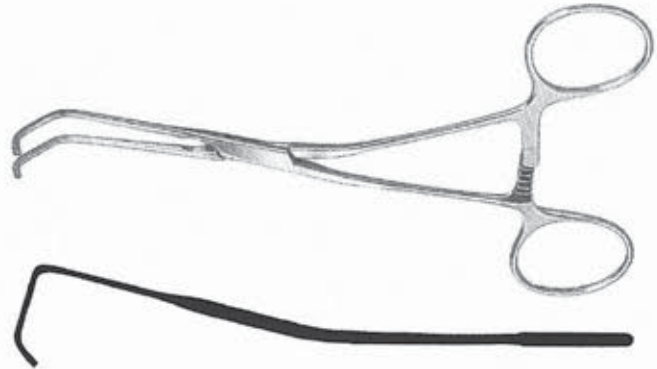
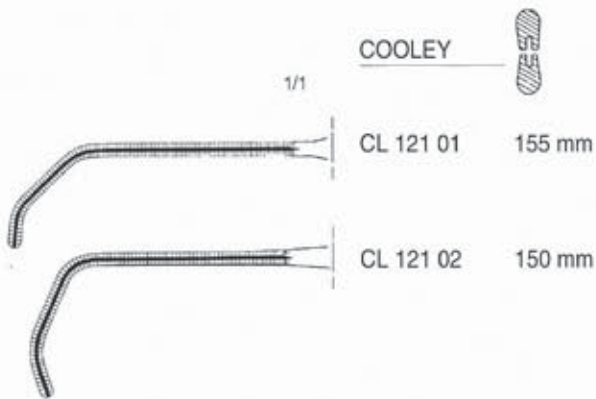

RENALE - VEINE CAVE

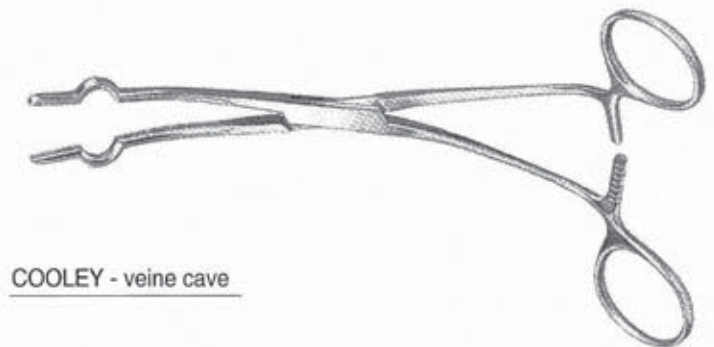
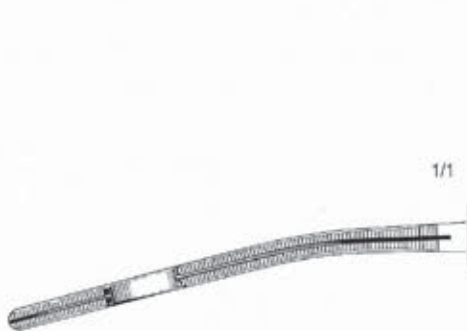
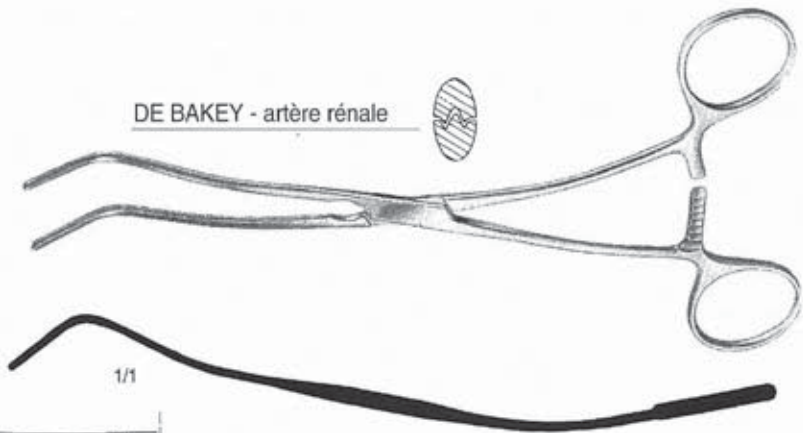
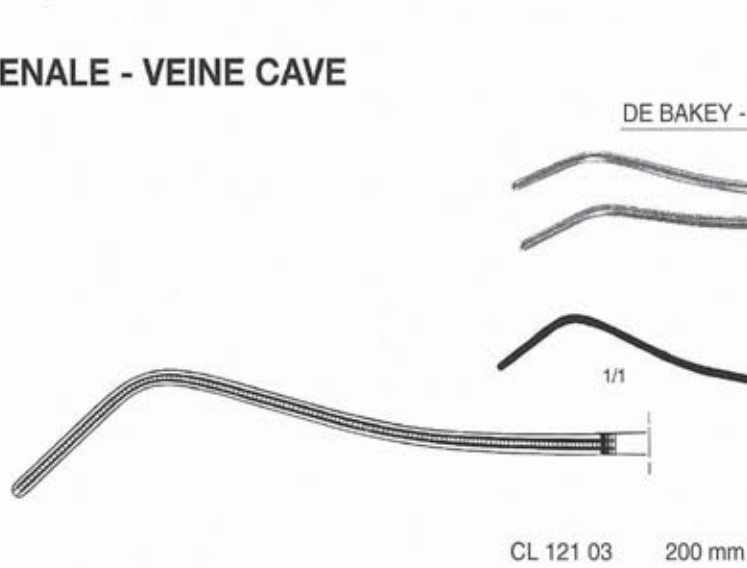

charrière du cathéter	pour enfants - 160 mm	pour adultes - 200 mm
24	CL 121 04	
26	CL 121 05	
28		CL 121 06
30		CL 121 07
32		CL 121 08
36		CL 121 09



















CLIPS ANEURISMES YASARGIL

CLIP STANDARD	PERMANENT				TEMPORAIRE			
	Réf.	Ouvert.	Mors	Pression	Réf.	Ouvert.	Mors	Pression
	CL 124 01	5,5 mm	7 mm	110-140 g				
	CL 124 02	5,3 mm	7 mm					
	CL 124 03	4,8 mm	7 mm					
	CL 124 04	5,0 mm	7 mm					
	CL 124 05	6,8 mm	7 mm					
	CL 124 06	6,0 mm	9 mm					
	CL 124 07	6,0 mm	9 mm					
	CL 124 08	5,0 mm	9 mm					
	CL 124 09	7,5 mm	9 mm					
	CL 124 10	6,8 mm	11 mm					
	CL 124 11	6,5 mm	11 mm	100-130 g	CL 124 19	7,3 mm	9 mm	40-50 g
	CL 124 12	5,8 mm	11 mm					
	CL 124 13	8,0 mm	15 mm					
	CL 124 14	7,5 mm	15 mm	100-130 g	CL 124 20	7,3 mm	9 mm	40-50 g
	CL 124 15	6,5 mm	15 mm					
	CL 124 16	6,8 mm	9 mm	110-140 g	CL 124 21	6,3 mm	9 mm	
	CL 124 17	3,8 mm	7 mm					
	CL 124 18	6,5 mm	7 mm					
					CL 124 22	10 mm	15 mm	60-80 g
					CL 124 23	9,3 mm	15 mm	
					CL 124 24	8,0 mm	15 mm	
					CL 124 25	12,0 mm	20 mm	80-100 g
					CL 124 26	11,5 mm	20 mm	



YASARGIL

CLIP MINI	PERMANENT				TEMPORAIRE				
	Réf.	Ouvert.	Mors	Pression	Réf.	Ouvert.	Mors	Pression	
									
	CL 125 01	3,0 mm	3 mm	100-130 g	CL 125 16	3,0 mm	3 mm	35-45 g	
	CL 125 02	3,0 mm	3 mm						
	CL 125 03	3,5 mm	5 mm		CL 125 17	3,5 mm	5 mm		
	CL 125 04	3,5 mm	5 mm		CL 125 18	3,5 mm	5 mm		
	CL 125 05	3,3 mm	5 mm						
	CL 125 06	3,0 mm	3 mm						
	CL 125 07	3,5 mm	5 mm						
	CL 125 08	3,5 mm	5 mm						
	CL 125 09	3,3 mm	5 mm						
	CL 125 10	3,0 mm	5 mm						
	CL 125 11	4,0 mm	7 mm			CL 125 19	4,0 mm	7 mm	40-50 g
	CL 125 12	3,8 mm	7 mm			CL 125 20	3,8 mm	7 mm	
	CL 125 13	3,5 mm	7 mm			CL 125 21	3,5 mm	7 mm	
	CL 125 14	5,0 mm	7 mm		80-100 g				
	CL 125 15	4,0 mm	7 mm		100-130 g				

PINCE A POSER

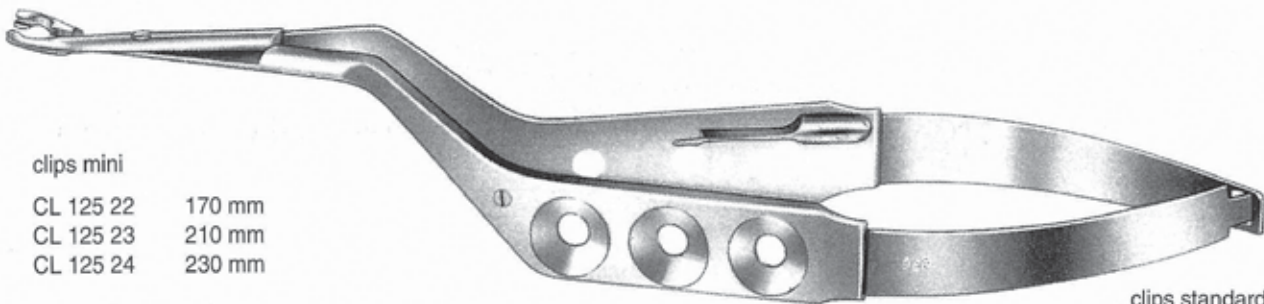

clips mini

- CL 125 22 170 mm
- CL 125 23 210 mm
- CL 125 24 230 mm

clips standard

- CL 125 25 170 mm
- CL 125 26 210 mm
- CL 125 27 230 mm



CLIPS

CUSHING (vaisseaux)



CL 126 01

0,7 x 5 mm (le 100)

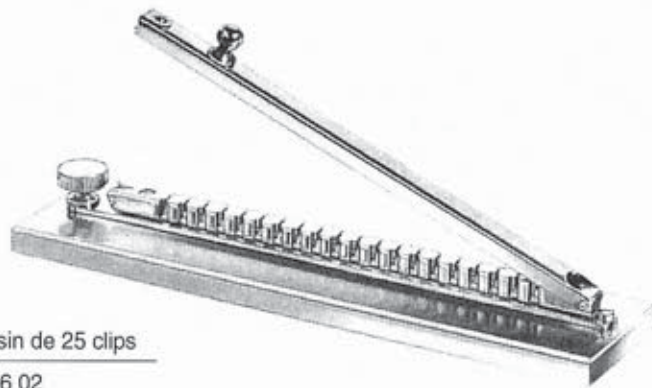

magasin de 25 clips

CL 126 02

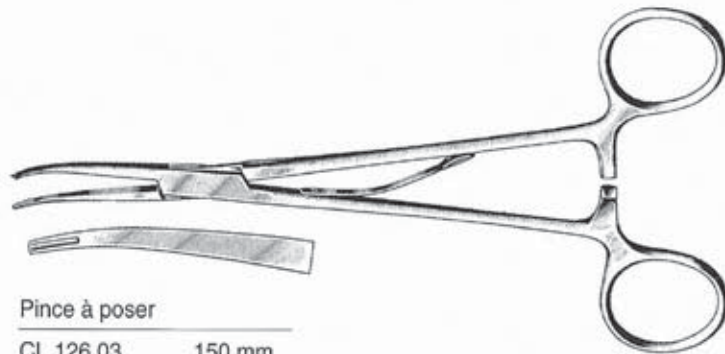

Pince à poser

CL 126 03 150 mm

COSTOTOMES

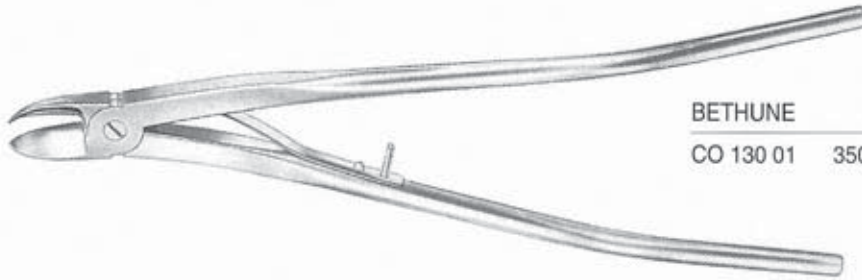

BETHUNE

CO 130 01 350 mm

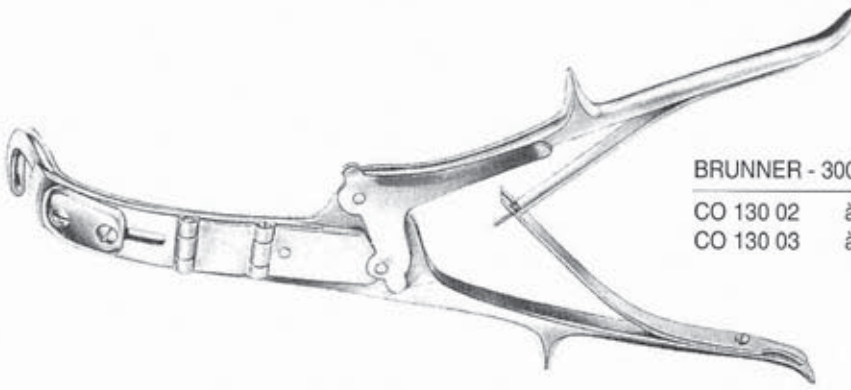

BRUNNER - 300 mm

CO 130 02 à droite

CO 130 03 à gauche



COLLIN ESLANDER

CO 130 04 adulte

CO 130 05 enfant

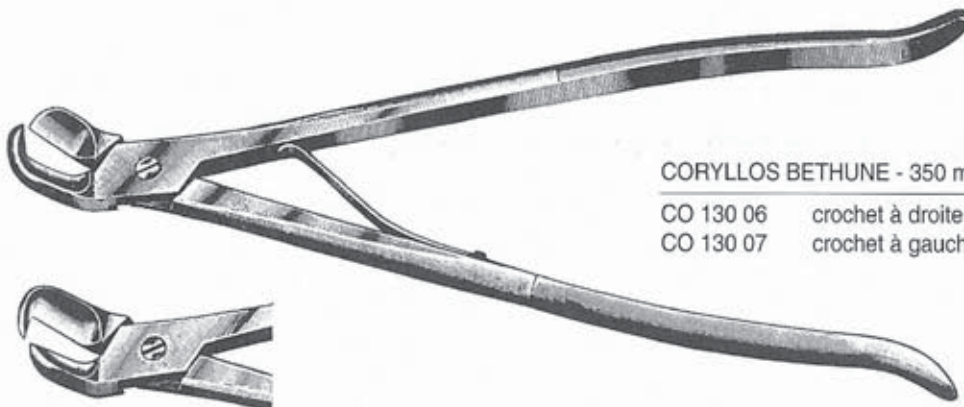

CORYLLOS BETHUNE - 350 mm

CO 130 06 crochet à droite

CO 130 07 crochet à gauche



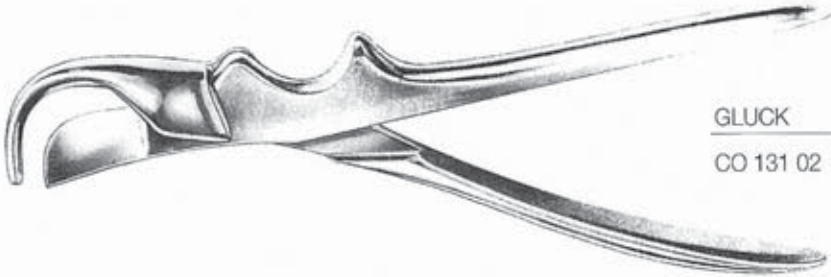

GLUCK
CO 131 02 220 mm



MAURER COLLIN			
Crochet à droite		Crochet à gauche	
CO 131 03	240 mm	CO 131 05	240 mm
CO 131 04	300 mm	CO 131 06	300 mm



ROOS pour la première côte
CO 131 07 330 mm

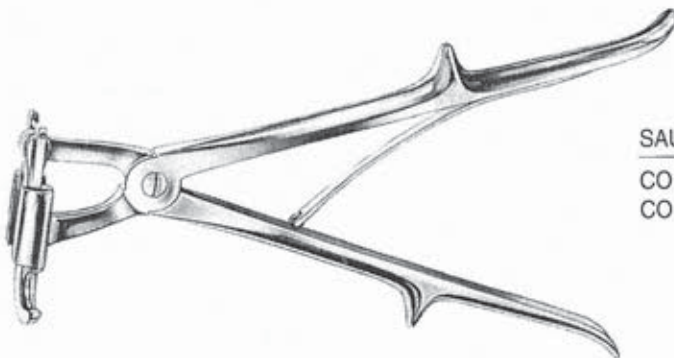

SAUERBRUCH
CO 131 08 230 mm
CO 131 09 260 mm



COSTOTOMES



SAUERBRUCH - FREY
CO 132 01 350 mm



STILLE
CO 132 02 210 mm

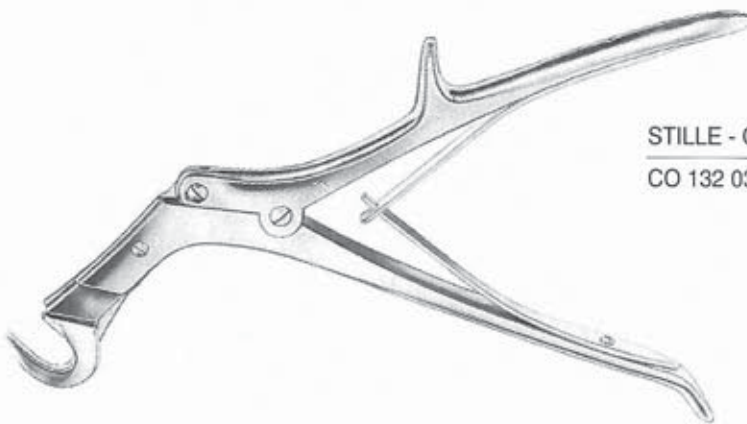

STILLE - GIERTZ
CO 132 03 270 mm



COUTEAUX - MENISQUES



BIRCHER
CO 134 01 190 mm



1/1 NEFF - 220 mm



CO 134 02 courbe à gauche



CO 134 03 courbe à droite

SMILLIE TRILLAT



CO 134 04 demi courbe



CO 134 05 tranchant à droite



CO 134 06 tranchant à gauche



COUTEAUX - O.R.L.



1/1

BALLENGER - rhinoplastie

CO 136 01 3 mm



CO 136 02 4 mm



CO 136 03 5 mm



BECKMANN - amygdales - végétations 200 mm

1/1



CO 136 04 12 mm



CO 136 07 16 mm



CO 136 05 13 mm



CO 136 08 18 mm



CO 136 06 15 mm



CO 136 09 20 mm



MOURE A PANIER - végétations

CO 137 01	10 mm	CO 137 04	19 mm
CO 137 02	13 mm	CO 137 05	21 mm
CO 137 03	16 mm		



MOURE SANS PANIER - végétations

CO 137 06	10 mm	CO 137 09	19 mm
CO 137 07	13 mm	CO 137 10	21 mm
CO 137 08	16 mm		



ST CLAIR - THOMSON - végétations



CO 137 11 16 mm



CO 137 13 20 mm



CO 137 12 18 mm



CO 137 14 23 mm



CROCHETS



BARSKY - tissus
 CR 139 01 150 mm pointu



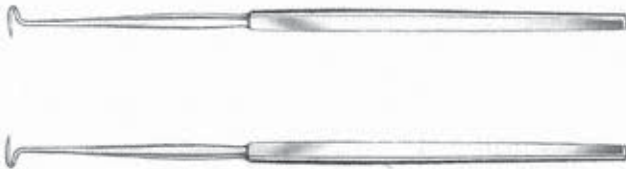

BERGMANN - à trachée
 CR 139 02 140 mm pointu



BOSE - 160 mm - à trachée
 à droite
 CR 139 03 pointu
 CR 139 04 mousse
 à gauche
 CR 139 05 pointu
 CR 139 06 mousse



CRILE - 220 mm - mousse
 nerfs et vaisseaux
 CR 139 07 45°
 CR 139 08 90°
 CR 139 09 courbe



CROCHETS



CUSHING - mousse
nerfs et vaisseaux

Fin 4 mm

1/1

Fort 6 mm

1/1



CR 140 01 190 mm
CR 140 02 280 mm

CR 140 03 190 mm
CR 140 04 280 mm

CUSHING - pointu
à dure - mère

CR 140 05 130 mm



1/1

DANDY - mousse - 230 mm
nerfs vaisseaux

CR 140 06 droit



CR 140 07 à droite



CR 140 08 à gauche



DINGMAN - maxillo - 190 mm

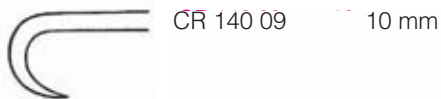

CR 140 09 10 mm



CR 140 10 20 mm





CROCHETS



DINGMAN - maxillo
 CR 141 01 175 mm



FRAZIER - 130 mm
 à Dure - mère
 CR 141 02 pointu



GILLIES - pointu - 190 mm
 à tissus

-  CR 141 03 fin
-  CR 141 04 fort



GRAEFE - 120 mm
 à tissus
 CR 141 05 mousse
 CR 141 06 pointu



GRAEFE - 160 mm
 à tissus
 CR 141 07 mousse
 CR 141 08 pointu



GRAHAM - 165 mm
 à nerfs
 CR 141 09 mousse



CROCHETS

JACKSON - pointu
à trachée

CR 142 01 130 mm
CR 142 02 150 mm



JOSEPH - pointu
à tissus

CR 142 03 150 mm



JOSEPH - DOUBLE - pointu - tissus

1/1



KLEINERT - KUTZ - pointu - 160 mm
à tissus

1/1

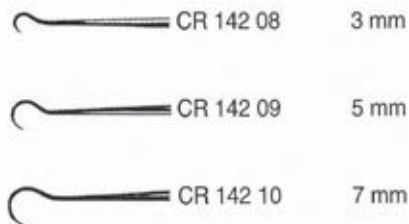

KRAYENBUHL - mousse - 185 mm

1/1





CROCHETS



LAMBOTTE - à os

CR 143 01	220 mm	petit
CR 143 02	250 mm	moyen
CR 143 03	280 mm	grand

LANGE - boutonné
à fistule

CR 143 04 220 mm

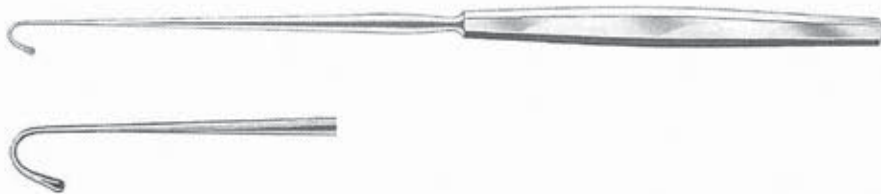

SIMON - pointu - 220 mm
à fistule



	CR 143 05	simple
	CR 143 06	double

SMITHWICK dissecteur
à nerf

CR 143 07 290 mm





TONNIS
à dure-mère - pointu

CR 144 01 150 mm



TRILLAT - à ménisque - mousse

CR 144 02 240 mm
(explorateur)



CR 144 03 240 mm



WAGNER - 140 mm - boutoné
à nerfs et vaisseaux

1/1





CURETTES

CALCULS - BILIAIRES



DESJARDINS
mousse - 260 mm

CU 146 01	6 mm
CU 146 02	8 mm
CU 146 03	10 mm
CU 146 04	12 mm

DESJARDINS - drague souple - 300 mm



1/1



CU 146 05

6 mm



CU 146 07

8 mm



CU 146 06

7 mm



CU 146 08

9 mm

DESJARDINS - explorateur - 280 mm



1/1



CU 146 09

Ø 4 mm



CU 146 11

Ø 8 mm



CU 146 10

Ø 6 mm

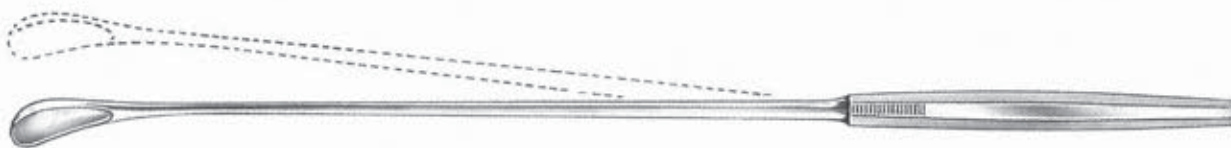

LUER - KORTE - MALLEABLE - 320 mm

1/1



CU 146 12

2,5 mm



CU 146 13

3,2 mm



CU 146 14

4,2 mm



CU 146 15

5,5 mm



CU 146 16

6,7 mm

1/1



CU 146 17

8 mm



CU 146 18

11 mm



CU 146 19

15 mm



CALCULS - BILIAIRES



1/1 MAYO - MALLEABLE - 270 mm



CU 147 01 petite



CU 147 02 grande



1/1 MOYNIHAN - malléable



CU 147 03 340 mm



NAIOKAZ - malléable

CU 147 04 270 mm

CALCULS - RENAUX



CHEVASSU - MALLEABLE - 280 mm

CU 147 05 4 mm

CU 147 06 7 mm

CU 147 07 8 mm



CURETTES

DERMATO



BESNIER - 135 mm - pleine - (Lupus)

CU 148 01	Ø 2 mm
CU 148 02	Ø 3 mm
CU 148 03	Ø 4 mm
CU 148 04	Ø 5 mm
CU 148 05	Ø 6 mm
CU 148 06	Ø 7 mm



BESNIER - 135 mm - fenêtrée - (Lupus)

CU 148 07	Ø 2 mm
CU 148 08	Ø 3 mm
CU 148 09	Ø 4 mm
CU 148 10	Ø 5 mm
CU 148 11	Ø 7 mm



BROCK GRATTOIR - mousse 130 mm

CU 148 12

VIDAL GRATTOIR - tranchant 130 mm

CU 148 13

GYNECO



GOURDET - Mousse - 260 mm

CU 148 14	Ø 4 mm	CU 148 18	Ø 12 mm
CU 148 15	Ø 6 mm	CU 148 19	Ø 14 mm
CU 148 16	Ø 8 mm	CU 148 20	Ø 16 mm
CU 148 17	Ø 10 mm		



KEVORKIAN - Biopsie - endo-utérine

CU 148 21 315 mm



GYNECO



RECAMIER - 300 mm

1/1		CU 149 01	5 mm	tranchante	1/1		CU 149 09	14 mm	tranchante
		CU 149 02	5 mm	mousse			CU 149 10	14 mm	mousse
		CU 149 03	7 mm	tranchante			CU 149 11	16 mm	tranchante
		CU 149 04	7 mm	mousse			CU 149 12	16 mm	mousse
		CU 149 05	9 mm	tranchante			CU 149 13	19 mm	tranchante
		CU 149 06	9 mm	mousse			CU 149 14	19 mm	mousse
		CU 149 07	12 mm	tranchante					
		CU 149 08	12 mm	mousse					



RECAMIER - FAUX GERMES mousse - 310 mm

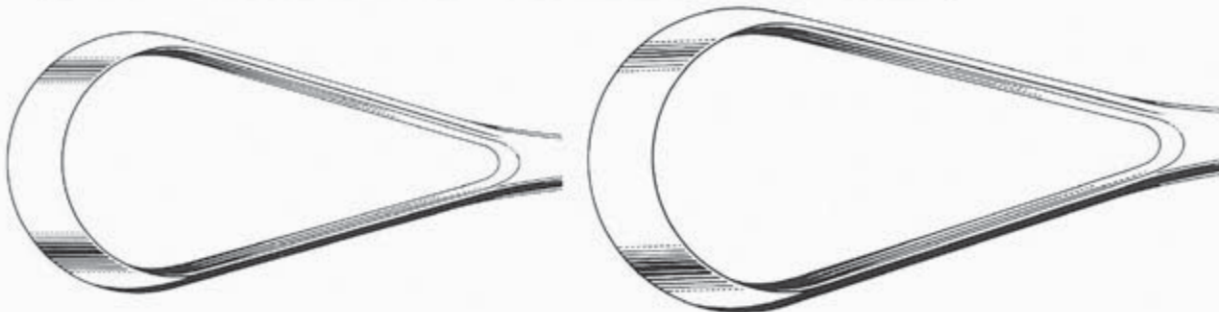

CU 149 15 35 mm

CU 149 16 40 mm



SCHRODER - TRANCHANTE - 300 mm

1/1		CU 149 17	7 mm	1/1		CU 149 21	13 mm
		CU 149 18	8,5 mm			CU 149 22	14 mm
		CU 149 19	10 mm				
		CU 149 20	12 mm				



CURETTES

GYNECO



SIMON - TRANCHANTE - 250 mm (VOLKMANN) - 280 mm pour les doubles courbures

1/1		CU 150 01	7 mm	droite	1/1		CU 150 09	13 mm	droite
		CU 150 02	7 mm	double courbure			CU 150 10	13 mm	double courbure
		CU 150 03	8,5 mm	droite			CU 150 11	14 mm	droite
		CU 150 04	8,5 mm	double courbure			CU 150 12	14 mm	double courbure
		CU 150 05	10 mm	droite			CU 150 06	10 mm	double courbure
		CU 150 07	12 mm	droite			CU 150 08	12 mm	double courbure



SIMS - TRANCHANTE - 280 mm (malléable sur demande)

1/1		CU 150 13	5 mm	1/1		CU 150 18	11 mm
		CU 150 14	6 mm			CU 150 19	12 mm
		CU 150 15	7 mm			CU 150 20	14 mm
		CU 150 16	8 mm				
		CU 150 17	9 mm				



WALLICH - MOUSSE - FAUX GERMES - 350 mm

CU 150 21	12 mm
CU 150 22	14 mm
CU 150 23	17 mm
CU 150 24	20 mm

WALLICH - MOUSSE - FAUX GERMES - 400 mm

CU 150 25	12 mm
CU 150 26	14 mm
CU 150 27	17 mm
CU 150 28	20 mm



O. R. L.

BLONDIAU - amygdales - 240 mm

CU 152 01 Ø 20 mm



BUCK - auriculaire - 165 mm

1/1	CU 152 02	Ø 1 mm	mousse
	CU 152 03	Ø 1 mm	tranchante
	CU 152 04	Ø 1,5 mm	mousse
	CU 152 05	Ø 1,5 mm	tranchante
	CU 152 06	Ø 2 mm	mousse
	CU 152 07	Ø 2 mm	tranchante
	CU 152 08	Ø 3 mm	mousse
	CU 152 09	Ø 3 mm	tranchante
	CU 152 10	Ø 3,5 mm	mousse
	CU 152 11	Ø 3,5 mm	tranchante

1/1	CU 152 12	Ø 4 mm	mousse
	CU 152 13	Ø 4 mm	tranchante
	CU 152 14	Ø 4,5 mm	mousse
	CU 152 15	Ø 4,5 mm	tranchante
	CU 152 16	Ø 5 mm	mousse
	CU 152 17	Ø 5 mm	tranchante

(angulée sur demande)

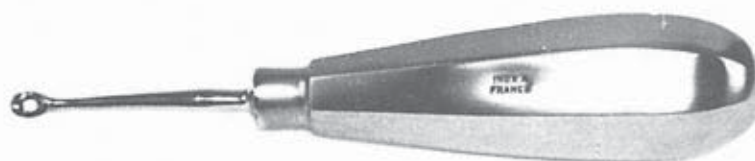

CHATELLIER - mastoïde - 140 mm

CU 152 18	3 mm	pleine
CU 152 19	3 mm	fenêtrée
CU 152 20	5 mm	pleine
CU 152 21	5 mm	fenêtrée
CU 152 22	7 mm	pleine
CU 152 23	7 mm	fenêtrée



CHOMPRET - maxillo - 150 mm - Ø 3 mm

CU 152 24	droite
CU 152 25	coudée à droite
CU 152 26	coudée à gauche



HOUSE - auriculaire - 150 mm

CU 152 27	droite
CU 152 28	coudée



CURETTES

O. R. L.



LEMPERT - auriculaire - 210 mm

1/1		1/1			
	CU 153 01	1,5 mm		CU 153 04	2,5 mm
	CU 153 02	2 mm		CU 153 05	2,7 mm
	CU 153 03	2,2 mm		CU 153 06	3 mm



LIMA - sinus - 270 mm

CU 153 07	3 mm
CU 153 08	5 mm
CU 153 09	7 mm



LUC - sinus - Ø 10 mm - 175 mm

1/1		1/1			
	CU 153 10	coudée à gauche		CU 153 12	droite
	CU 153 11	coudée à droite			



MEYHOFER - pour la caisse - 130 mm

	CU 153 13	1 mm		CU 153 16	3,5 mm
	CU 153 14	2 mm		CU 153 17	4 mm
	CU 153 15	2,5 mm			



O. R. L.



MOURE - sinus - 180 mm - Ø 5 mm

 CU 154 01 droite

 CU 154 02 coudée à gauche

 CU 154 03 coudée à droite

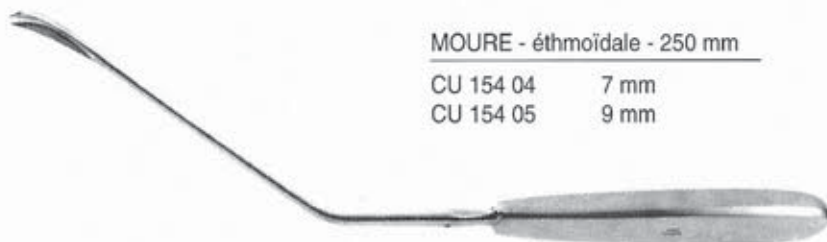

MOURE - éthmoïdale - 250 mm

CU 154 04 7 mm

CU 154 05 9 mm



SEBILEAU - sinus - 210 mm

demi courbe

CU 154 06 5 mm

CU 154 07 6 mm

CU 154 08 7 mm

courbe

CU 154 09 5 mm

CU 154 10 6 mm

CU 154 11 7 mm





CURETTES

OSSEUSES



BRUNS - droite - 230 mm

1/1		CU 156 01	1,5 mm	1/1		CU 156 07	4,8 mm
		CU 156 02	2,0 mm			CU 156 08	6,1 mm
		CU 156 03	2,5 mm			CU 156 09	6,7 mm
		CU 156 04	3,3 mm			CU 156 10	8,8 mm
		CU 156 05	3,7 mm				
		CU 156 06	4,3 mm				



BRUNS - angulée - 230 mm

1/1		CU 156 11	1,5 mm	1/1		CU 156 17	4,8 mm
		CU 156 12	2,0 mm			CU 156 18	6,1 mm
		CU 156 13	2,5 mm			CU 156 19	6,7 mm
		CU 156 14	3,3 mm			CU 156 20	8,8 mm
		CU 156 15	3,7 mm				
		CU 156 16	4,3 mm				



BRUNS - manche hexagonal plein - 230 mm











1/1		CU 156 21	1,5 mm	1/1		CU 156 27	4,8 mm
		CU 156 22	2,0 mm			CU 156 28	6,1 mm
		CU 156 23	2,5 mm			CU 156 29	6,7 mm
		CU 156 24	3,3 mm			CU 156 30	8,8 mm
		CU 156 25	3,7 mm				
		CU 156 26	4,3 mm				



OSSEUSES



BRUNS VOLKMANN 170 mm

1/1		CU 157 01	2,6 mm	1/1		CU 157 07	10,2 mm
		CU 157 02	3,3 mm			CU 157 08	11,8 mm
		CU 157 03	4,8 mm			CU 157 09	12,8 mm
		CU 157 04	5,8 mm			CU 157 10	14 mm
		CU 157 05	7,3 mm				
		CU 157 06	8,3 mm				

CLOVIS - VINCENT - DOUBLE - 200 mm









CU 157 11	Ø 3 et 4 mm
CU 157 12	Ø 5 et 6 mm
CU 157 13	Ø 7 et 8 mm
CU 157 14	Ø 9 et 10 mm



malléable sur demande : rajouter la lettre «M» en fin de référence



CLOWARD - droite - 200 mm

1/1		CU 157 15	2 mm	1/1		CU 157 21	6,1 mm
		CU 157 16	2,8 mm			CU 157 22	6,7 mm
		CU 157 17	3,3 mm			CU 157 23	8,8 mm
		CU 157 18	3,7 mm				
		CU 157 19	4,3 mm				
		CU 157 20	4,8 mm				



CURETTES OSSEUSES



CLOWARD - angulée - 200 mm

1/1		CU 158 01	2 mm	1/1		CU 158 07	6,1 mm
		CU 158 02	2,8 mm			CU 158 08	6,7 mm
		CU 158 03	3,3 mm			CU 158 09	8,8 mm
		CU 158 04	3,7 mm				
		CU 158 05	4,3 mm				
		CU 158 06	4,8 mm				



CLOWARD - contre coudée - 200 mm

1/1		CU 158 10	2 mm
		CU 158 11	2,8 mm
		CU 158 12	3,3 mm



VOLKMANN



	170 mm	200 mm	240 mm	280 mm
2 mm	CU 158 13	CU 158 14		
3 mm	CU 158 15	CU 158 16		
4 mm	CU 158 17	CU 158 18	CU 158 40	CU 158 51
5 mm	CU 158 19	CU 158 20	CU 158 41	
6 mm	CU 158 21	CU 158 22	CU 158 42	CU 158 53
7 mm	CU 158 23	CU 158 24		
8 mm	CU 158 25	CU 158 26	CU 158 44	CU 158 55
10 mm	CU 158 27	CU 158 28	CU 158 45	CU 158 56



	170 mm	200 mm	240 mm	280 mm
12 mm	CU 158 29	CU 158 30	CU 158 46	CU 158 57
14 mm	CU 158 31	CU 158 32	CU 158 47	CU 158 58
16 mm	CU 158 33	CU 158 34		CU 158 59
18 mm				CU 158 60
20 mm				CU 158 61

WILLIGER - 135 mm



CU 158 35	Ø 2,5 mm et Ø 3 mm
CU 158 36	Ø 3 mm et Ø 3,5 mm
CU 158 37	Ø 3,5 mm et Ø 4 mm



D

PAGES

DAVIER A OS

162 - 166

DILATATEURS

TRACHEAUX

168

VASCULAIRES

168 - 169

VOIES BILIAIRES

169

DISSECTEURS SUR MANCHE

171 - 173



DEPRESSEUR A VESSIE

VOIR

VALVES

DESENCLAVEUR

VOIR

TIRE FIBROME

DILATATEUR DE HEGAR

VOIR

BOUGIES

DILATATEUR RECTAL

VOIR

ECARTEUR AUTOSTATIQUE ALAN PARKS

DISSECTEURS

VOIR

ELEVATEURS

DISSECTEURS PASSE FILS

VOIR

PASSE FILS

DRAGUES BILIAIRES

VOIR

CURETTES



DAVIERS A OS

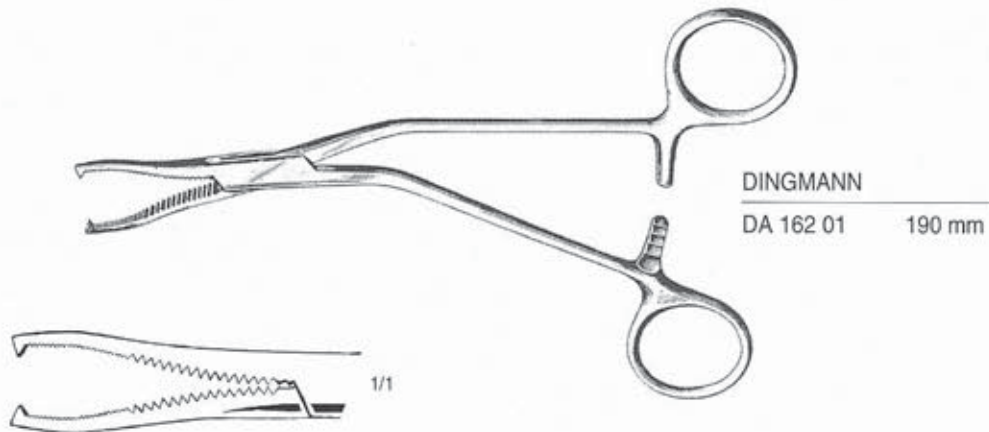

DINGMANN
DA 162 01 190 mm

FARABEUF - sans crémaillère

DA 162 02	170 mm
DA 162 03	190 mm
DA 162 04	260 mm



FARABEUF - à crémaillère

DA 162 05	170 mm
DA 162 06	190 mm
DA 162 07	260 mm

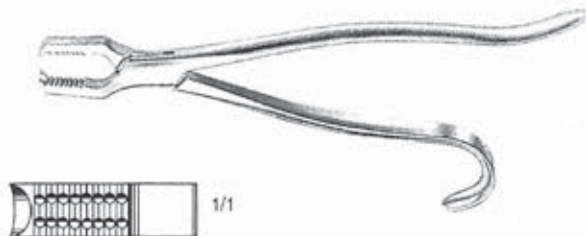
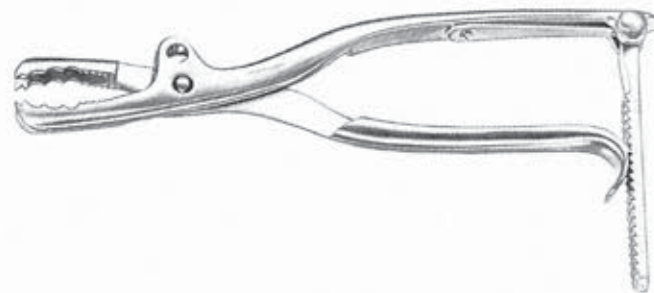

KERN - LANE - sans crémaillère

DA 162 08	150 mm
DA 162 09	170 mm
DA 162 10	210 mm

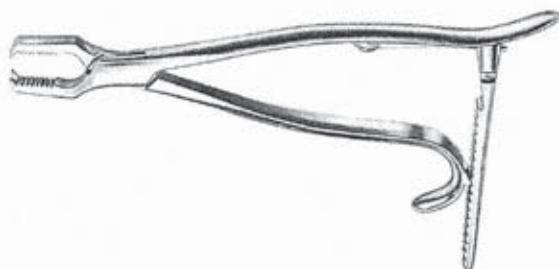

KERN - LANE - à crémaillère

DA 162 11	150 mm
DA 162 12	170 mm
DA 162 13	210 mm



DAVIERS A OS

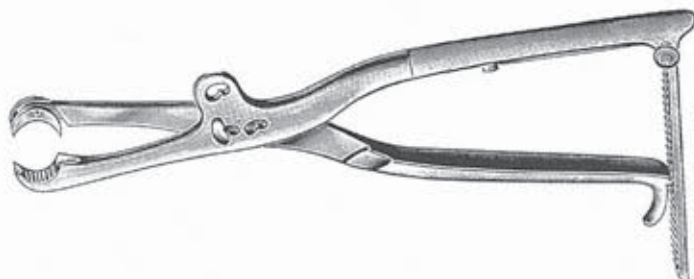

LAMBOTTE - droit

DA 163 01	220 mm
DA 163 02	260 mm
DA 163 03	330 mm

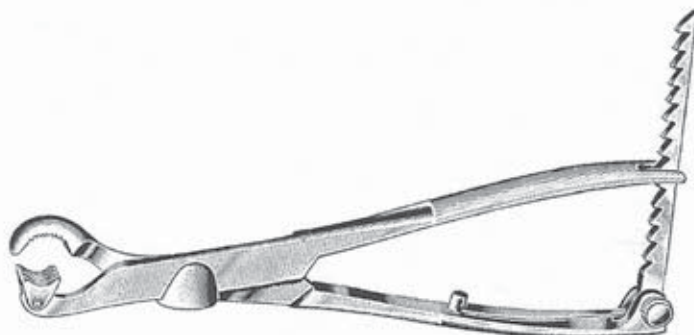

LAMBOTTE - en S

DA 163 07	220 mm
DA 163 08	260 mm
DA 163 09	330 mm

LANE - sans crémailière

DA 163 10	330 mm
DA 163 11	450 mm

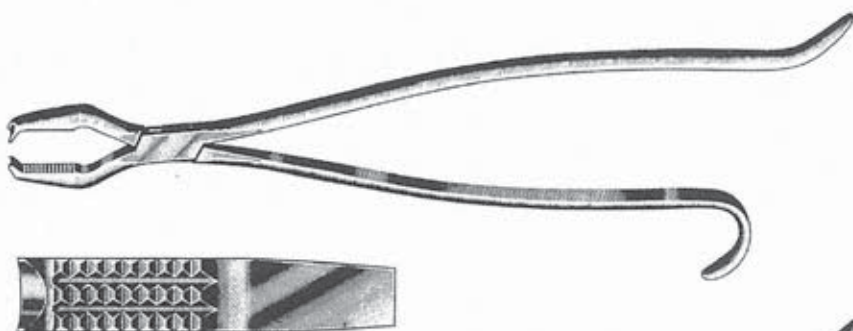

LANE - à crémailière

DA 163 12	330 mm
DA 163 13	450 mm

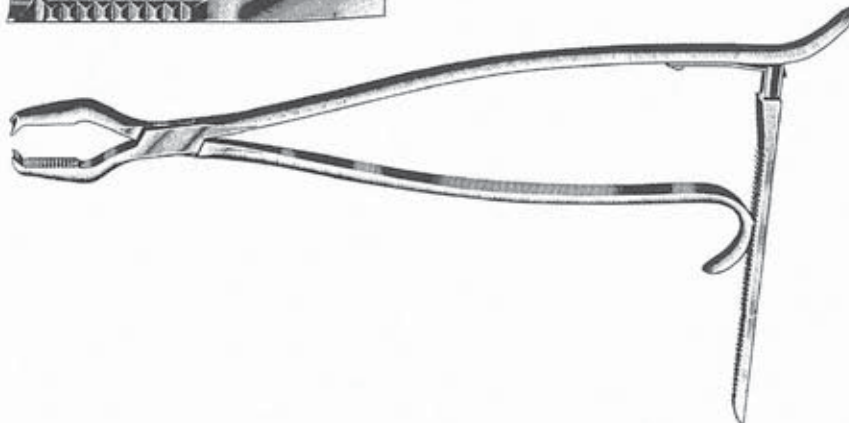



DAVIERS A OS

LOWMAN

DA 164 01	180 mm
DA 164 02	200 mm
DA 164 03	220 mm

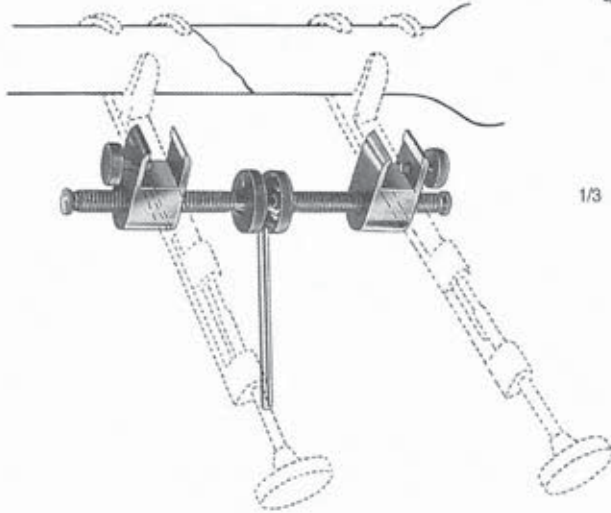
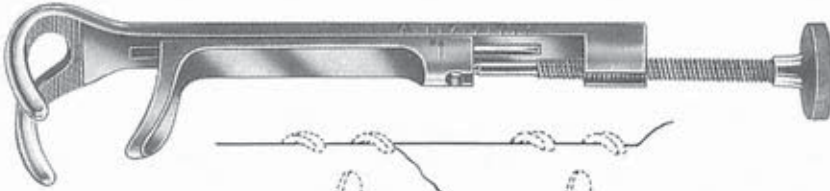

1/3

dispositif pour réduction

DA 164 04

OLLIER - pour rotule

DA 164 05	190 mm
DA 164 06	220 mm
DA 164 07	270 mm



REDUCTEUR

DA 164 08	135 mm
-----------	--------

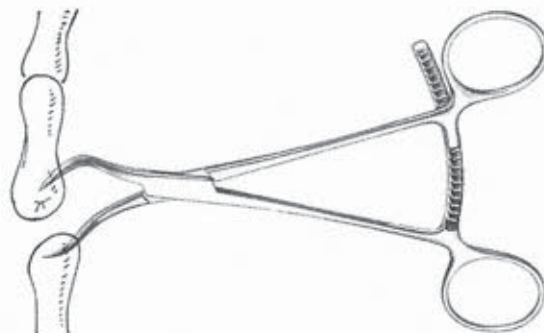



DAVIERS A OS

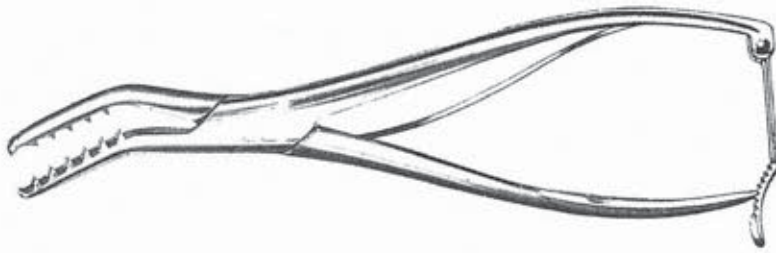

SEMB - à crémaillère
DA 165 01 200 mm

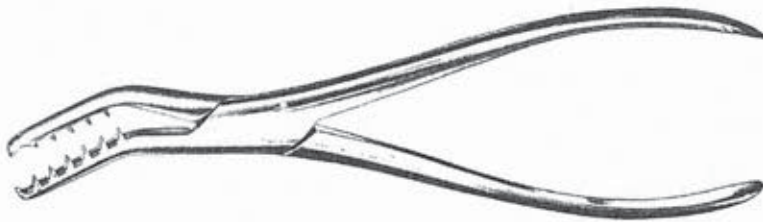

SEMB - sans crémaillère
DA 165 02 200 mm



SEQUESTRE - pince - 200 mm
DA 165 03 droit
DA 165 04 courbe

SETTER - réducteur
DA 165 05 145 mm

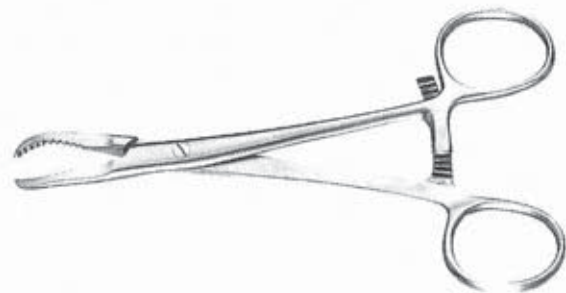

VERBRUGGE - 160 mm
pour la main

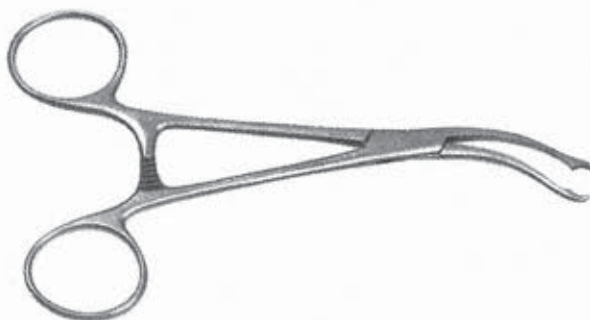

DA 165 06 2 mors dentés préhenseur



DA 165 07 1 mors denté - 1 mors acéré réducteur



DAVIERS A OS

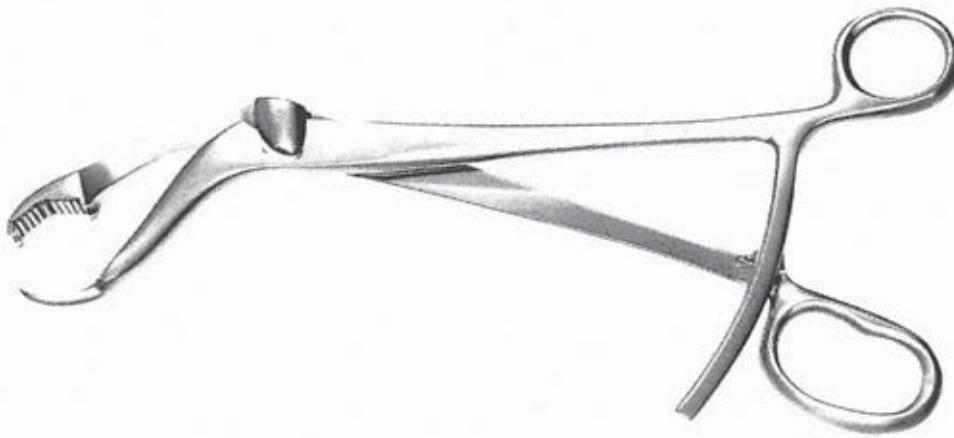

VERBURE - REDUCTEUR - 1 mors denté - 1 mors acéré



DA 166 09	150 mm
DA 166 01	180 mm
DA 166 02	240 mm
DA 166 03	260 mm
DA 166 04	280 mm



1/1

VERBURE - PREHENSEUR - 2 mors denté

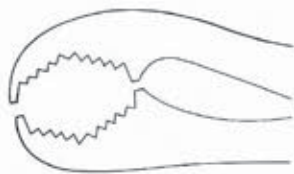

DA 166 10	150 mm
DA 166 05	180 mm
DA 166 06	240 mm
DA 166 07	260 mm
DA 166 08	280 mm



DILATATEURS

TRACHEAUX

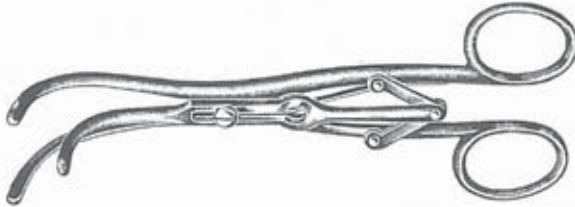

LABORDE
DI 168 01 145 mm

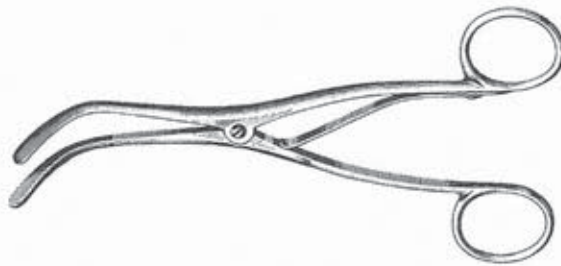

TROUSSEAU
DI 168 02 140 mm

VASCULAIRES



DE BAKEY

			longueur			longueur
	DI 168 03	Ø 1 mm	190 mm		DI 168 17	Ø 8 mm 190 mm
	DI 168 04	Ø 1 mm	240 mm		DI 168 18	Ø 8 mm 240 mm
	DI 168 05	Ø 2 mm	190 mm		DI 168 19	Ø 9 mm 190 mm
	DI 168 06	Ø 2 mm	240 mm		DI 168 20	Ø 9 mm 240 mm
	DI 168 07	Ø 3 mm	190 mm		DI 168 21	Ø 10mm 190 mm
	DI 168 08	Ø 3 mm	240 mm		DI 168 22	Ø 10mm 240 mm
	DI 168 09	Ø 4 mm	190 mm		DI 168 23	Ø 11 mm 190 mm
	DI 168 10	Ø 4 mm	240 mm		DI 168 24	Ø 11 mm 240 mm
	DI 168 11	Ø 5 mm	190 mm		DI 168 25	Ø 12 mm 190 mm
	DI 168 12	Ø 5 mm	240 mm		DI 168 26	Ø 12 mm 240 mm
	DI 168 13	Ø 6 mm	190 mm		DI 168 27	Ø 13 mm 190 mm
	DI 168 14	Ø 6 mm	240 mm		DI 168 28	Ø 13 mm 240 mm
	DI 168 15	Ø 7 mm	190 mm			
	DI 168 16	Ø 7 mm	240 mm			



DILATATEURS

VASCULAIRES



GARRET - 200 mm

DI 169 01	Ø 1 mm	DI 169 06	Ø 3,5 mm
DI 169 02	Ø 1,5 mm	DI 169 07	Ø 4 mm
DI 169 03	Ø 2 mm	DI 169 08	Ø 4,5 mm
DI 169 04	Ø 2,5 mm	DI 169 09	Ø 5 mm
DI 169 05	Ø 3 mm		

VOIES BILIAIRES



BAKES - 300 mm

DI 169 10	1 mm	DI 169 17	8 mm
DI 169 11	2 mm	DI 169 18	9 mm
DI 169 12	3 mm	DI 169 19	10 mm
DI 169 13	4 mm	DI 169 20	11 mm
DI 169 14	5 mm	DI 169 21	12 mm
DI 169 15	6 mm	DI 169 22	13 mm
DI 169 16	7 mm		



DISSECTEURS SUR MANCHE



CARPENTER - pour amygdales
DI 171 01 260 mm

CLOVIS - VINCENT - tranchant
pour dure - mère
DI 171 02 200 mm



COTTLE - pour cloison
DI 171 03 210 mm 1 côté mousse
1 côté tranchant



CREED - 210 mm
DI 171 04



DAVIS - pour dure - mère - 245 mm
DI 171 05 1 côté mousse
1 côté tranchant

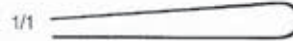

FRAZIER - pour dure - mère
DI 171 06 150 mm



DISSECTEURS SUR MANCHE

FREER - pour cloison

DI 172 01 200 mm 1 côté mousse
1 côté tranchant

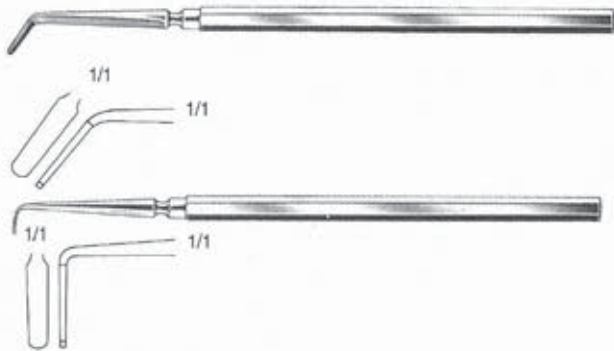

HOEN - 150 mm - pour dure - mère

DI 172 02 coudé 45°

DI 172 03 coudé 90°

HURD - 225 mm - pour amygdales

DI 172 04



KILLIAN - 190 mm - pour cloison

DI 172 05 1 côté mousse
1 côté tranchant

KILLIAN - 220 mm - pour cloison

DI 172 06 1 côté mousse
1 côté tranchant





DISSECTEURS SUR MANCHE



LERICHE - mousse

DI 173 01	170 mm x 3,5 mm
DI 173 02	210 mm x 4 mm
DI 173 03	210 mm x 5 mm
DI 173 04	250 mm x 3,5 mm
DI 173 05	250 mm x 6 mm

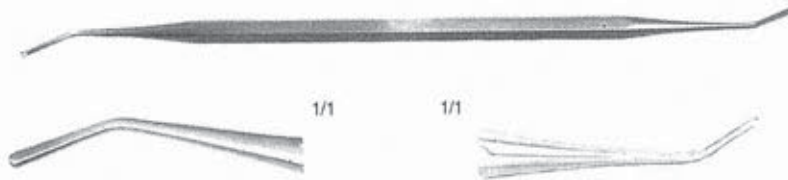

ROBB

DI 173 06 210 mm

SACHS - tranchant - pour dure - mère
DI 173 07 210 mm



TONNIS - mousse - pour dure - mère
DI 173 08 240 mm

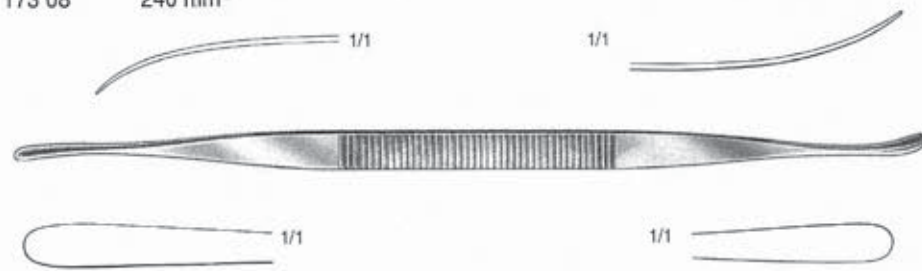



E

PAGES

ECARTEURS

DOUBLE	175 - 178
SUR MANCHE	180 - 200
ABDOMINAUX	203 - 217
AUTOSTATIQUES	218 - 228
AUTOSTATIQUES POUR LE RACHIS	230 - 237
THORACIQUES	239 - 242

ECRASEURS INTESTINAUX

244

ELEVATEURS

245 - 246

ETRIERS

247



ECARTEURS CEREBRAL
 ECARTEURS SUR MANCHE
 EPINGLE PORTE PINCE
 EXPLORATEURS BILIAIRES

VOIR
 VOIR
 VOIR
 VOIR

SPATULES
 VALVES
 CADRE PORTE INSTRUMENTS
 CURETTES



ECARTEURS (DOUBLES)

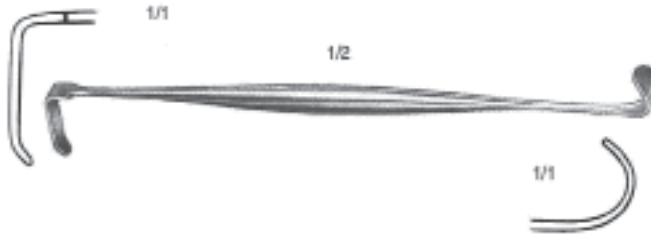

COPE - 160 mm

EC 175 01 largeur 6 et 11mm

CRILE - 110 mm

largeur x profondeur

EC 175 02 4 x 12 mm et 6 x 20 mm



FARABEUF (la paire)

EC 175 03	100 mm	largeur 7 et 6 mm	profondeur 18 et 15 mm
EC 175 04	120 mm	largeur 10 et 8 mm	profondeur 25 et 20 mm
EC 175 05	140 mm	largeur 15 et 10 mm	profondeur 30 et 25 mm
EC 175 06	200 mm (corty)	largeur 30 et 40 mm	profondeur 40 et 55 mm

HARTMANN - 160 mm
(la paire)

EC 175 07
profondeur 40 et 45 mm
Avec renfort central

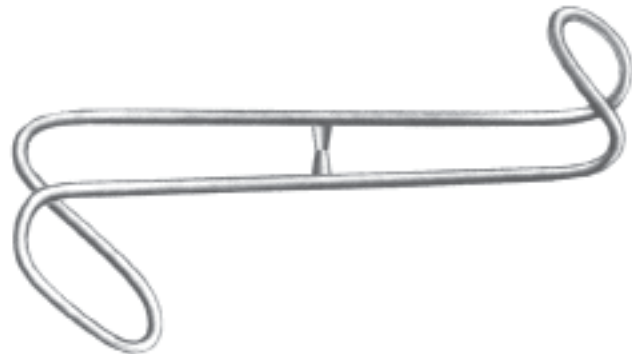



ECARTEURS (DOUBLES)

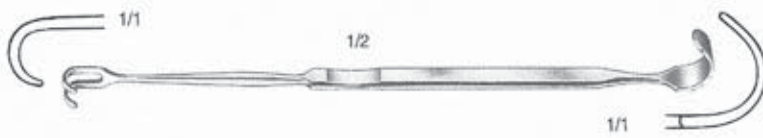

JACKSON - 170 mm
écarteur trachéal
EC 176 01 largeur 6 x 9 mm



LUCKENS - 170 mm
EC 176 02



LUER - 110 mm
EC 176 03 largeur 10 et 12 mm

MATHIEU (la paire)
EC 176 04 largeur 13 et 26 mm





ECARTEURS (DOUBLES)

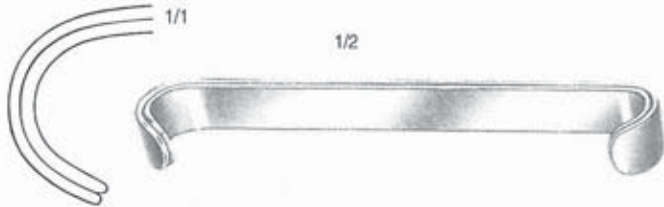

PARKER (la paire)

EC 177 01 135 mm

EC 177 02 180 mm

RAGNELL - 160 mm
écarteur pour la main

EC 177 03 largeur 2,5 et 5 mm

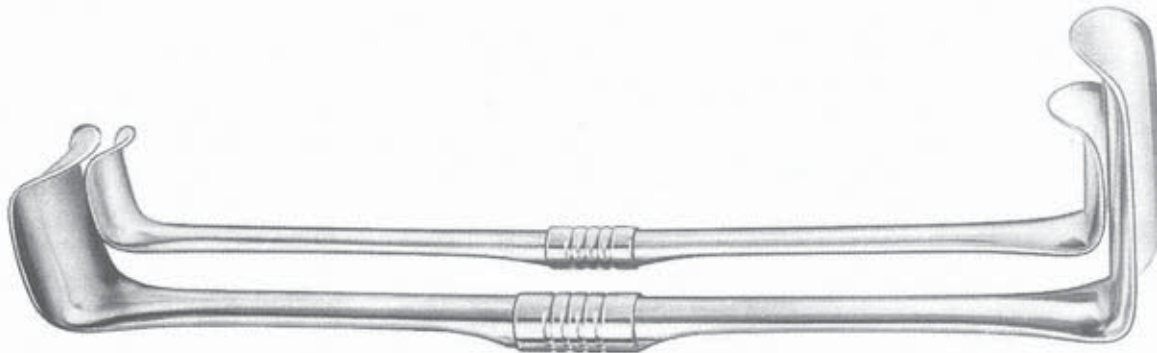

RICHARDSON EASTMANN
écarteur vasculaire

largeur x profondeur

EC 177 04	260 mm	23 x 25 et 30 x 32 mm
EC 177 05	280 mm	38 x 41 et 42 x 65 mm
EC 177 06	la paire	

ROSE - 130 mm

EC 177 07 largeur 12 et 14 mm

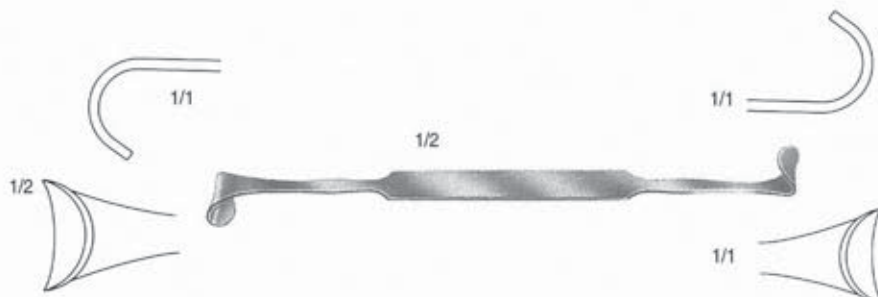



ECARTEURS (DOUBLES)

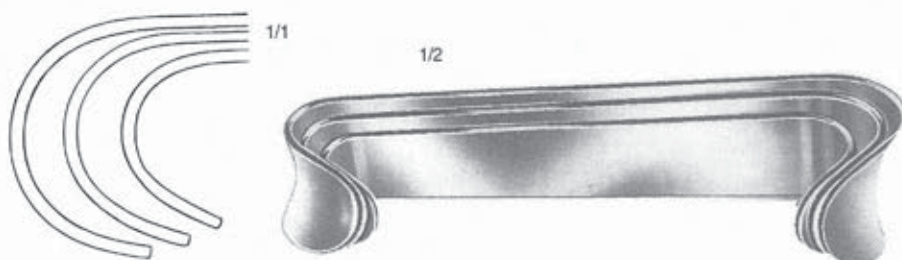

ROUX

		largeur
EC 178 01	140 mm	22 et 28 mm
EC 178 02	150 mm	26 et 38 mm
EC 178 03	160 mm	29 et 44 mm
EC 178 04	jeu de 3	

SENN MILLER - 160 mm

- EC 178 05 griffes mousses
- EC 178 06 griffes pointues



SENN MILLER BABY - 150 mm

- EC 178 07 griffes mousses
- EC 178 08 griffes pointues

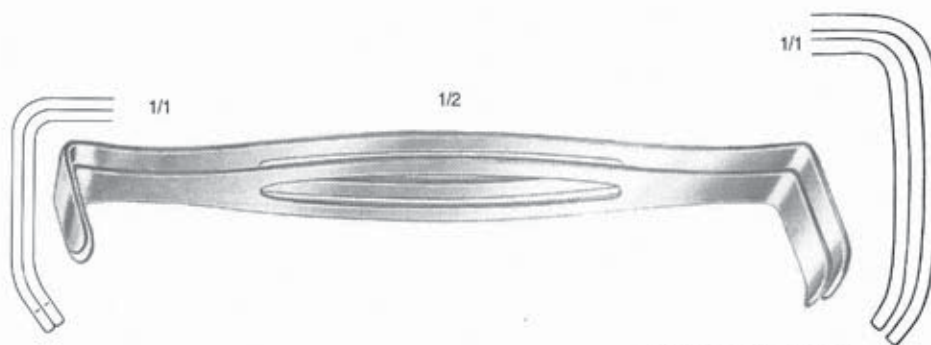

U.S. ARMY - 210 mm

	largeur x profondeur
EC 178 09	15 x 29 et 16 x 42 mm
EC 178 10	15 x 33 et 16 x 46 mm
EC 178 11	jeu de 2



ECARTEURS (SUR MANCHE)



AUFRICHT - 160 mm
 écarteur nasal
 EC 180 01 lame de 45 mm

BENNETT - 260 mm
 écarteur à os

	largeur
EC 180 02	50 mm
EC 180 03	60 mm
EC 180 04	65 mm



BLOUNT - 170 mm
 écarteur pour le genou
 EC 180 05 5 x 40 mm

CLOWARD - 197 mm
 écarteur à racine

	largeur x profondeur
EC 180 06	12,5 x 11,5 mm





ECARTEURS (SUR MANCHE)

CLOWARD - 197 mm - POUR LE RACHIS

lame largeur x profondeur

EC 181 01 11 x 38 mm



CLOWARD - 180 mm - POUR LE RACHIS

lame largeur x profondeur

EC 181 02 18 x 76 mm

EC 181 03 20 x 76 mm

EC 181 04 23 x 76 mm



COOLEY
pour pose de valves

lame largeur x profondeur

EC 181 05 30 x 25 mm

EC 181 06 30 x 30 mm

EC 181 07 30 x 35 mm

EC 181 08 30 x 40 mm

EC 181 09 30 x 45 mm

EC 181 10 30 x 50 mm



CORYLLOS - 225 mm
écarteur à poumons

lame largeur x profondeur

EC 181 11 20 x 82 mm

EC 181 12 38 x 115 mm

EC 181 13 65 x 115 mm

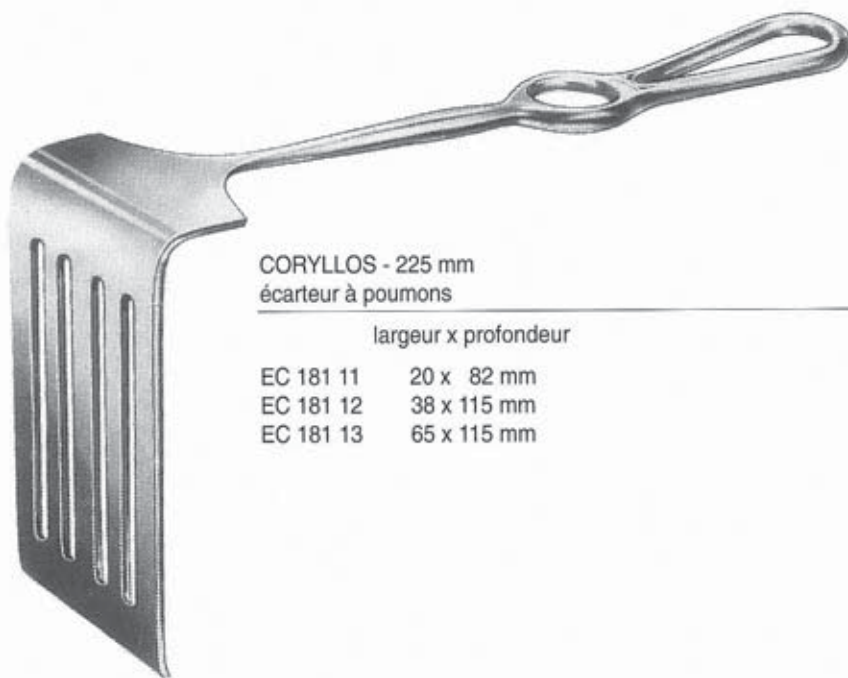



ECARTEURS (SUR MANCHE)



CUSHING
 écarteur à paupières - pour vaisseaux ou nerfs

8 mm 10 mm 12 mm 14 mm 16 mm 18 mm

1/1



EC 182 01
 EC 182 07

1/1



EC 182 02
 EC 182 08

1/1



EC 182 03
 EC 182 09

1/1



EC 182 04
 EC 182 10

1/1



EC 182 05
 EC 182 11

1/1



EC 182 06
 EC 182 12

200 mm
 240 mm



CUSHING - 250 mm

largeur x profondeur

14 x 11 mm



1/1

EC 182 13

18 x 13 mm



1/1

EC 182 14

22 x 15 mm



1/1

EC 182 15



CUSHING - 200 mm







largeur x profondeur

EC 182 16 10 x 18 mm coudé

ECARTEURS (SUR MANCHE)







DESMARRES - 160 mm
écarteur à paupières, à vaisseaux

8 mm	10 mm	12 mm	14 mm	16 mm	18 mm
					
1/1	1/1	1/1		1/1	1/1
EC 183 01	EC 183 02	EC 183 03	EC 183 04	EC 183 05	EC 183 06

FARABEUF MINI - 160 mm
pour la main







largeur x profondeur

			
1/1	1/1	1/1	1/1
6 x 10 mm EC 183 07	5 x 17 mm EC 183 08	6 x 20 mm EC 183 09	8 x 22 mm EC 183 10



FARABEUF - 220 mm

largeur x profondeur

10 x 30 mm	16 x 30 mm	10 x 40 mm	10 x 50 mm
			
1/1	1/1	1/1	1/1
EC 183 11	EC 183 12	EC 183 13	EC 183 14



ECARTEURS (SUR MANCHE)

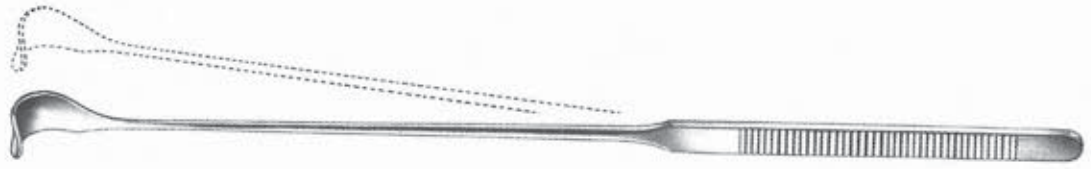

GILVERNET
écarteur à sinus rénal

9 mm

11 mm

13 mm

15 mm

18 mm



malléable 280 mm
rigide 250 mm

EC 184 01
EC 184 06

EC 184 02
EC 184 07

EC 184 03
EC 184 08

EC 184 04
EC 184 09

EC 184 05
EC 184 10



GUILLAUME - 150 mm
écarteur à racine

EC 184 11 largeur 5 mm



ECARTEURS (SUR MANCHE)

HOHMANN - 150 mm
levier à os



EC 185 01 largeur 2,8 mm



EC 185 02 largeur 5 mm



EC 185 03 largeur 7 mm

HOHMANN - 160 mm
levier à os



EC 185 04 largeur 6 mm



EC 185 05 largeur 7,5 mm



EC 185 06 largeur 8 mm



ECARTEURS (SUR MANCHE)



1/1

HOHMANN - 220 mm

EC 186 01 largeur 8 mm



1/2



1/1

HOHMANN - 240 mm

EC 186 02 largeur 18 mm



1/2



1/1

HOHMANN - 240 mm

EC 186 03 largeur 43 mm

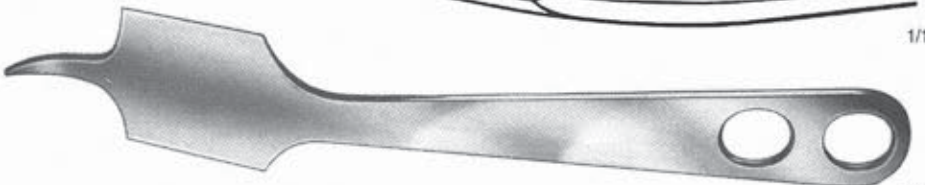

1/2



1/1

HOHMANN - 240 mm

EC 186 04 largeur 70 mm



1/2



ECARTEURS (SUR MANCHE)



1/1

HOHMANN - 260 mm



1/2

EC 187 01 largeur 22 mm



1/1

HOHMANN - 260 mm



1/2

EC 187 02 largeur 22 mm



1/1



1/2

HOHMANN - 265 mm

EC 187 03 largeur 24 mm



1/1

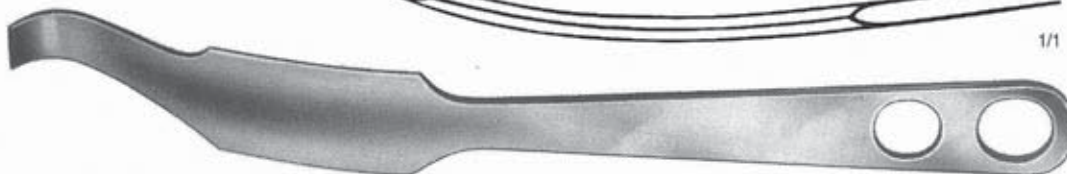

1/2 HOHMANN - 280 mm

EC 187 04 largeur 33 mm



ECARTEURS (SUR MANCHE)



1/2

KLAPP - 175 mm (VALUDE)
écarteur à tendons



1/1

EC 188 01 2 griffes



EC 188 02 3 griffes



1/2

LANGENBECK - 210 mm - largeur x profondeur



1/1

10 x 30 mm EC 188 03



1/1

16 x 30 mm EC 188 04



1/1

10 x 40 mm EC 188 05



1/1

10 x 50 mm EC 188 06



ECARTEURS (SUR MANCHE)

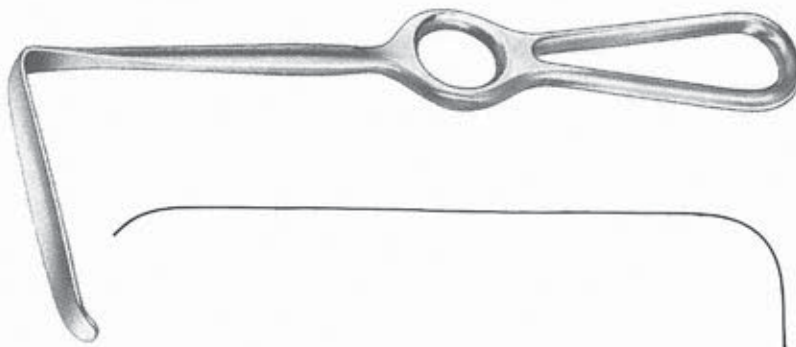

1/2 LANGENBECK - 210 mm
 largeur x profondeur
 EC 189 01 15 x 85 mm

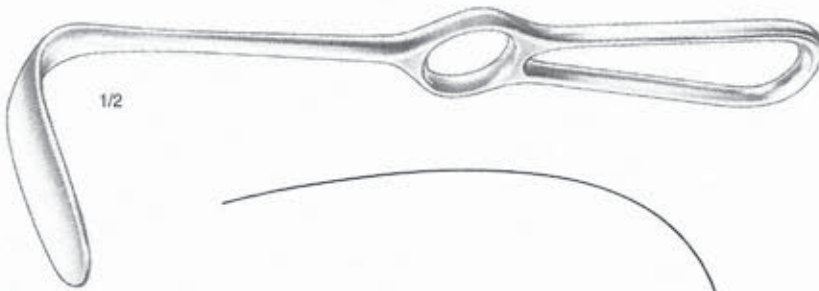
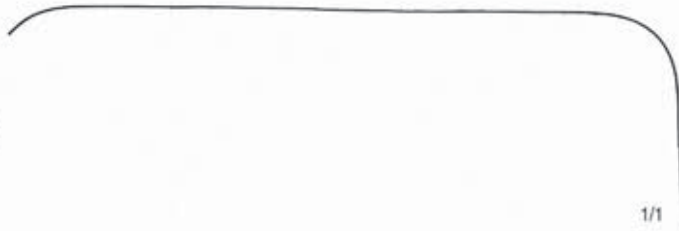

LANGENBECK - 210 mm

largeur x profondeur
 EC 189 02 20 x 63 mm

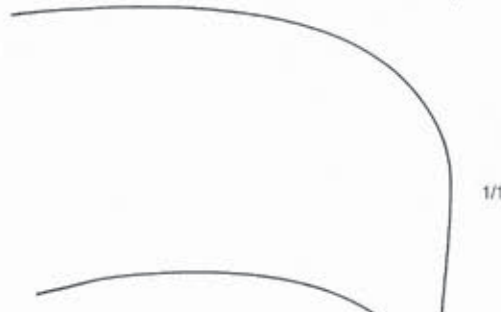
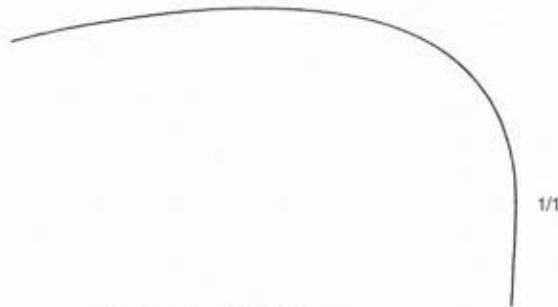

EC 189 03 20 x 60 mm

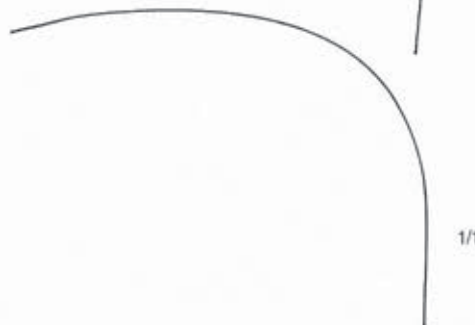

EC 189 04 20 x 55 mm



ECARTEURS (SUR MANCHE)



LOVE - 190 mm
 écarteur à paupières, pour nerfs, et
 vaisseaux.

EC 190 01 droit

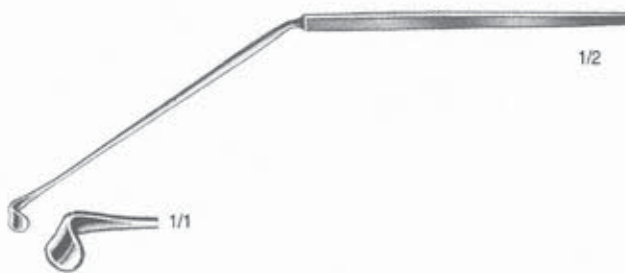

EC 190 02 coudé à 45 degrés

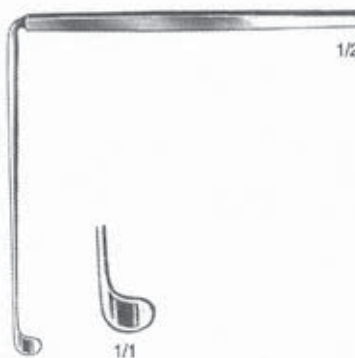

EC 190 03 coudé à 90 degrés

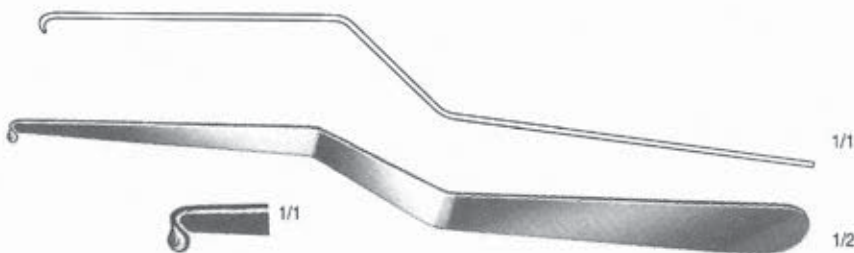

LOVE - 210 mm

EC 190 04 en baïonnette



ECARTEURS (SUR MANCHE)

MERLE D'AUBIGNE
écarteur à os

largeur x profondeur

- EC 191 01 180 mm lame 12 x 35 mm
- EC 191 02 200 mm lame 16 x 60 mm
- EC 191 03 200 mm lame 20 x 60 mm



MERLE D'AUBIGNE - 250 mm
écarteur à os

largeur x profondeur

- EC 191 04 20 x 90 mm
- EC 191 05 30 x 90 mm
- EC 191 06 30 x 110 mm
- EC 191 07 50 x 110 mm



MIDDELDORPF
pour le genou

longueur	215 mm	220 mm	235 mm
----------	--------	--------	--------



largeur x profondeur	14 x 17 mm EC 191 08	20 x 22 mm EC 191 09	26 x 30 mm EC 191 10
----------------------	-------------------------	-------------------------	-------------------------







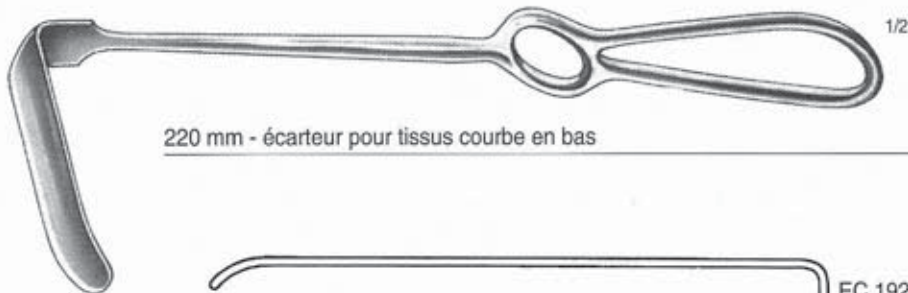

ECARTEURS (SUR MANCHE)

CHIRURGIE MAXILLO - FACIALE D'OBWEGESER



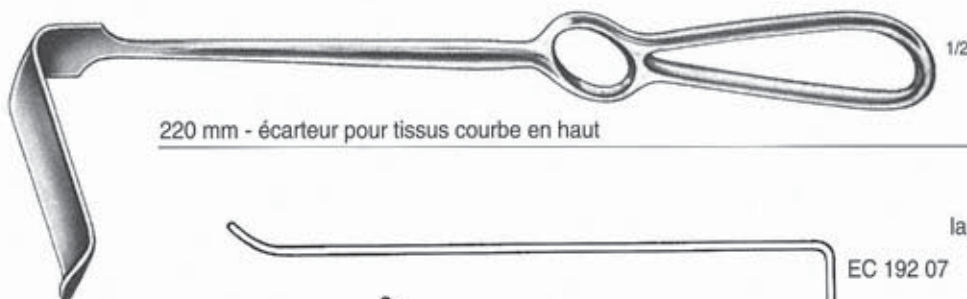

220 mm - écarteur pour tissus courbe en bas

	largeur x profondeur
	EC 192 01 16 x 80 mm
	EC 192 02 14 x 70 mm
	EC 192 03 12 x 55 mm
	EC 192 04 11 x 42 mm
	EC 192 05 10 x 31 mm
	EC 192 06 7 x 25 mm



220 mm - écarteur pour tissus courbe en haut

	largeur x profondeur
	EC 192 07 16 x 80 mm
	EC 192 08 12 x 60 mm
	EC 192 09 13 x 42 mm



ECARTEURS (SUR MANCHE)

CHIRURGIE MAXILLO - FACIALE D'OBWEGESER

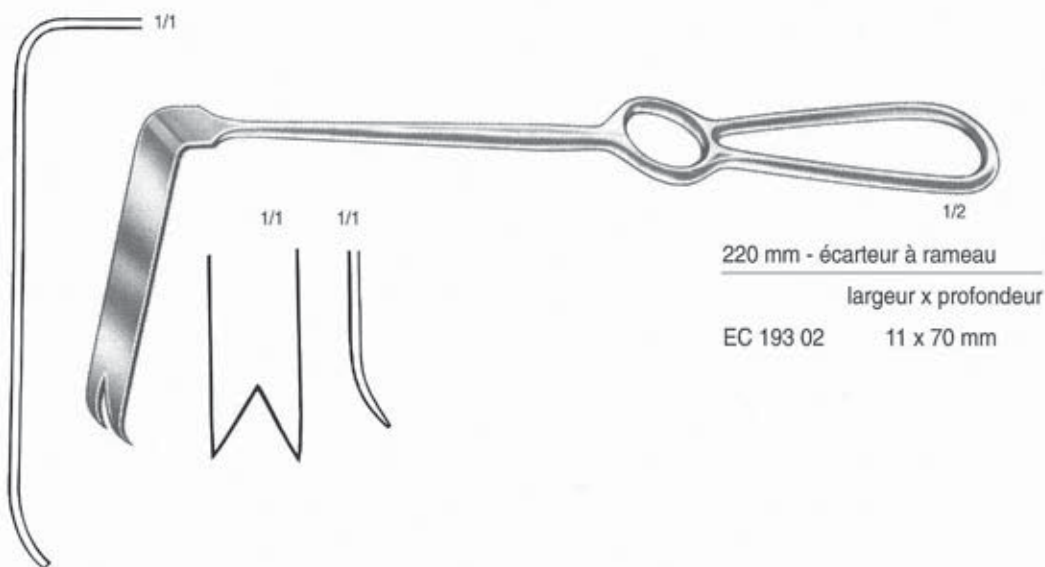



ECARTEURS (SUR MANCHE)

OLLIER - 203 mm
écarteur à os

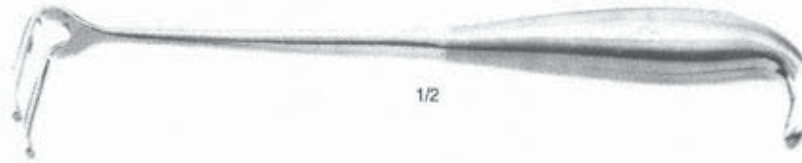

	largeur	profondeur
EC 194 01	25 mm	50 mm
EC 194 02	35 mm	50 mm
EC 194 03	45 mm	50 mm
EC 194 04	60 mm	50 mm
EC 194 09	35 mm	70 mm



PAUL - 120 mm
pour la main



	largeur x profondeur
EC 194 05	8 x 11 mm

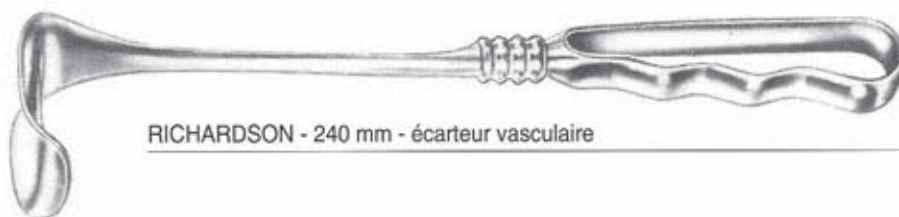

RICHARDSON - 240 mm - écarteur vasculaire

1/2



20 x 28 mm
EC 194 06



largeur x profondeur
28 x 30 mm
EC 194 07



1/2
37 x 38 mm
EC 194 08



ECARTEURS (SUR MANCHE)

ROLLET - 130 mm
pour la main
EC 195 01 griffes pointues

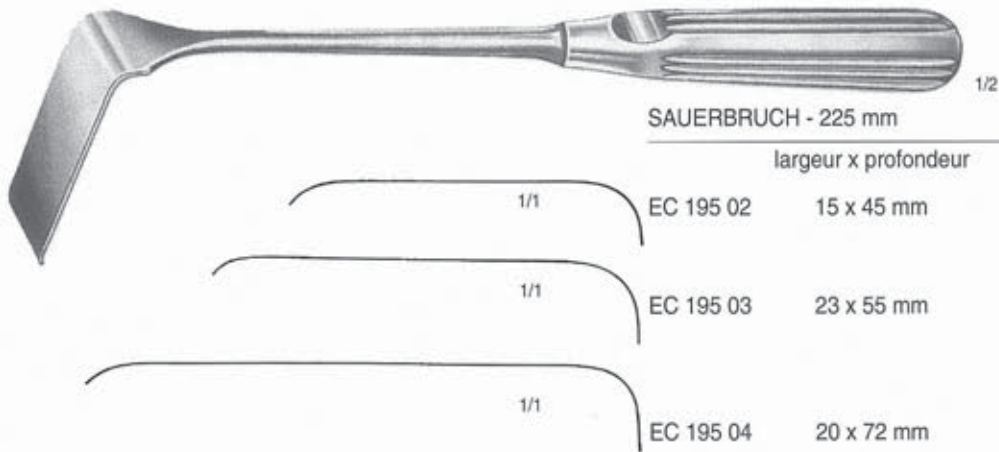

SAUERBRUCH - 225 mm

largeur x profondeur

EC 195 02 15 x 45 mm

EC 195 03 23 x 55 mm

EC 195 04 20 x 72 mm

SCHONBORN - 210 mm
écarteur à vaisseaux

largeur x profondeur

EC 195 05 5 x 13 mm

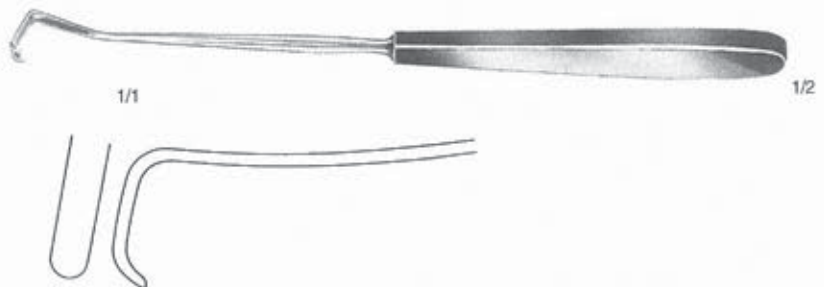



ECARTEURS (SUR MANCHE)

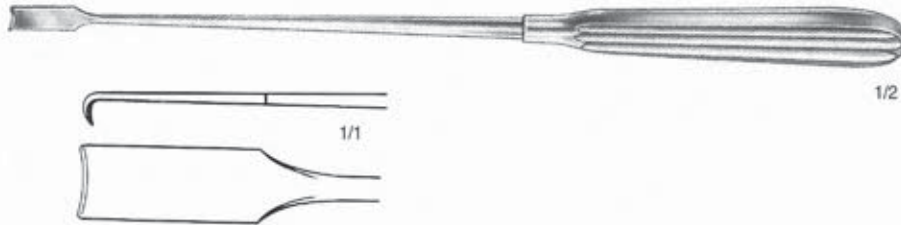

SCOVILLE - 230 mm
écarteur à racine
EC 196 01 largeur 8 mm

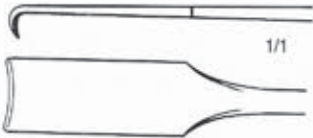

SCOVILLE - 200 mm - angulé
EC 196 02 largeur 8 mm

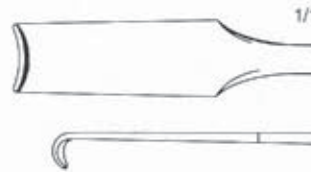
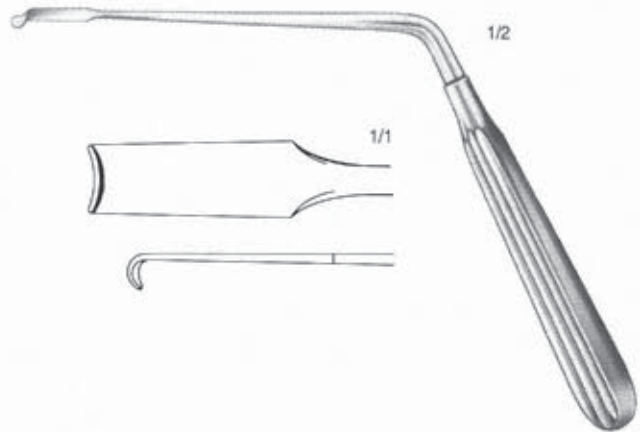

SENN - GREEN - 160 mm - pour la main



6 x 10 mm
EC 196 03

largeur x profondeur



6 x 20 mm
EC 196 04



ECARTEURS (SUR MANCHE)

SMILLIE TRILLAT - 150 mm
pour le genou



EC 197 01 très courbe 12 mm



largeur x profondeur
EC 197 02 coudé 20 x 50 mm
EC 197 03 coudé 20 x 70 mm



EC 197 04 double courbure 20 x 70



STRANDELL STILLE - 190 mm
6 x 15 mm largeur x profondeur



EC 197 05 mors dentés



EC 197 06 mors lisses



TAYLOR - 170 mm
pour rachis lombaire

largeur x profondeur

EC 197 07 30 x 75 mm
EC 197 08 30 x 100 mm





ECARTEURS (SUR MANCHE)



VOLKMANN - 160 mm
tige à ressort

1/2



1/1



1/1



1/1

griffes mousses
griffes pointues

2
EC 198 01
EC 198 04

3
EC 198 02
EC 198 05

4
EC 198 03
EC 198 06



VOLKMANN - 160 mm - gros manche

1/2



2



3



4



5



6

griffes mousses
griffes pointues

EC 198 07
EC 198 12

EC 198 08
EC 198 13

EC 198 09
EC 198 14

EC 198 10
EC 198 15

EC 198 11
EC 198 16



VOLKMANN - 220 mm - gros manche



2



3



4

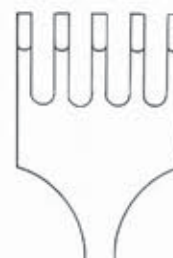

5

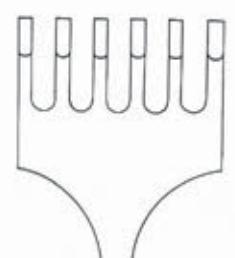

6

griffes mousses
griffes pointues

EC 198 17
EC 198 22

EC 198 18
EC 198 23

EC 198 19
EC 198 24

EC 198 20
EC 198 25

EC 198 21
EC 198 26

ECARTEURS (SUR MANCHE)



VOLKMANN - 220 mm



2

EC 199 01
EC 199 05



3

EC 199 02
EC 199 06



4

EC 199 03
EC 199 07

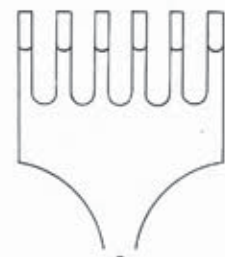

6

EC 199 04
EC 199 08

griffes mousses
griffes pointues



VOLKMANN - 160 mm - petit manche



1/1

1

EC 199 09
EC 199 13



1/1

2

EC 199 10
EC 199 14



1/1

3

EC 199 11
EC 199 15



1/1

4

EC 199 12
EC 199 16

griffes mousses
griffes pointues



VOLKMANN - 230 mm - RADIO TRANSPARENT
griffes pointues

EC 199 19 7 griffes
EC 199 20 8 griffes



ECARTEURS (SUR MANCHE)

ZENKER - 250 mm

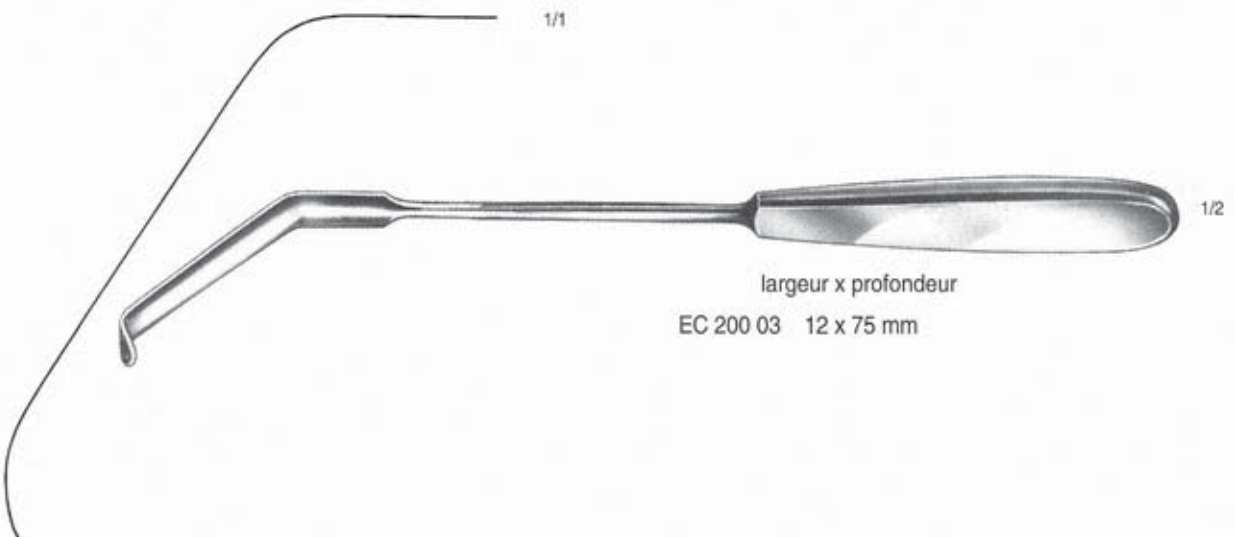
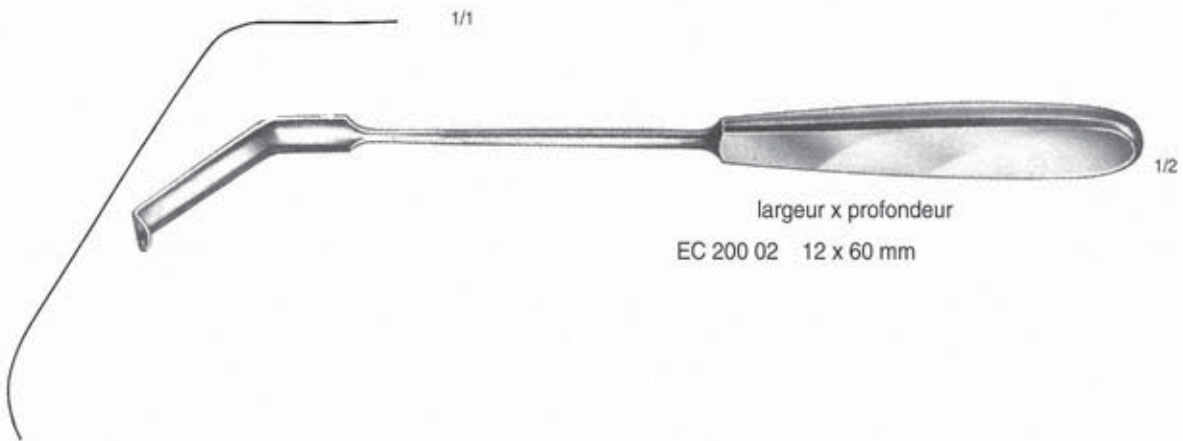
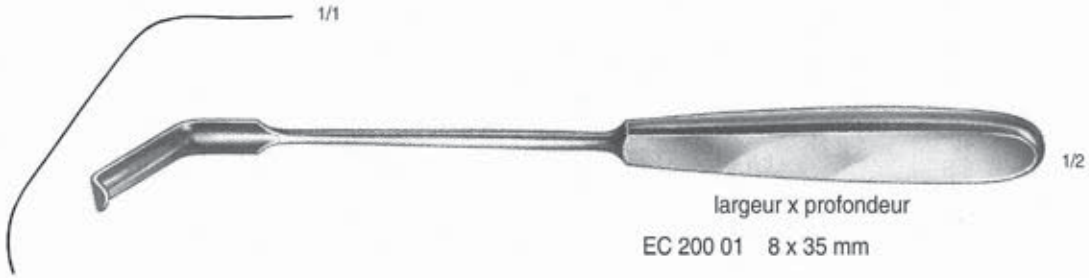

ECARTEURS ABDOMINAUX

BALFOUR



REFERENCE	OUVERTURE	VALVES LATERALES	VALVE MEDIANE
		Profondeur	Largeur x profondeur
EC 203 01	90 mm	27 mm	25 x 25 mm
EC 203 02	180 mm	70 mm	80 x 45 mm
EC 203 03	200 mm	100 mm	85 x 70 mm
EC 203 04	250 mm	100 mm	85 x 70 mm

ECARTEURS ABDOMINAUX

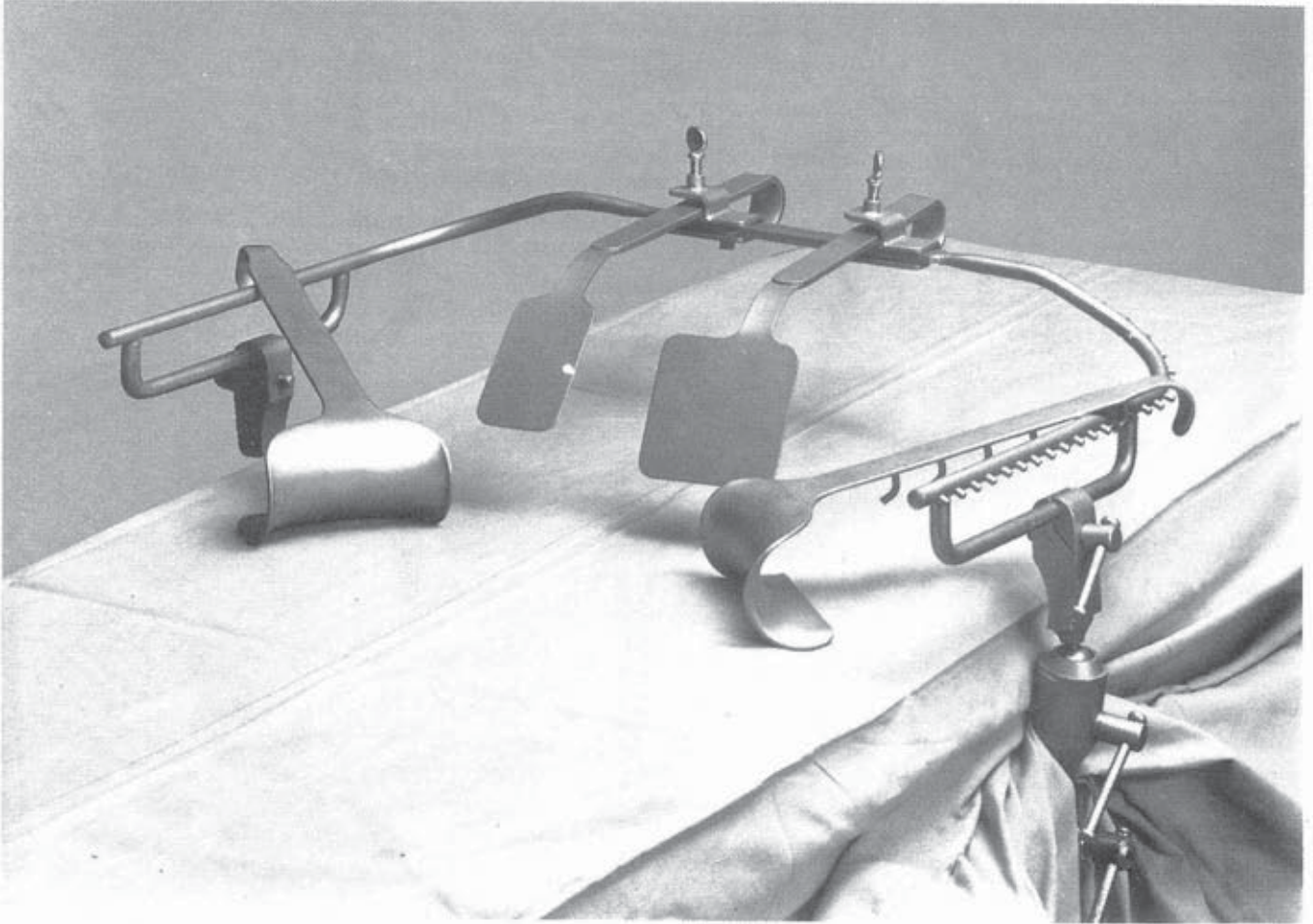
BERGERET

EC 204 01 CADRE COMPLET COMPRENANT :

EC 204 02 1 cadre seul.

EC 204 03 1 curseur pour valve à foie.

EC 204 04 1 paire de piquets.

EC 204 05 1 paire de valves latérales - largeur 80 mm profondeur 50 mm.

EC 204 06 1 valve à foie malléable - largeur 50 mm.

EC 204 07 1 valve à foie malléable - largeur 80 mm.

ECARTEURS ABDOMINAUX

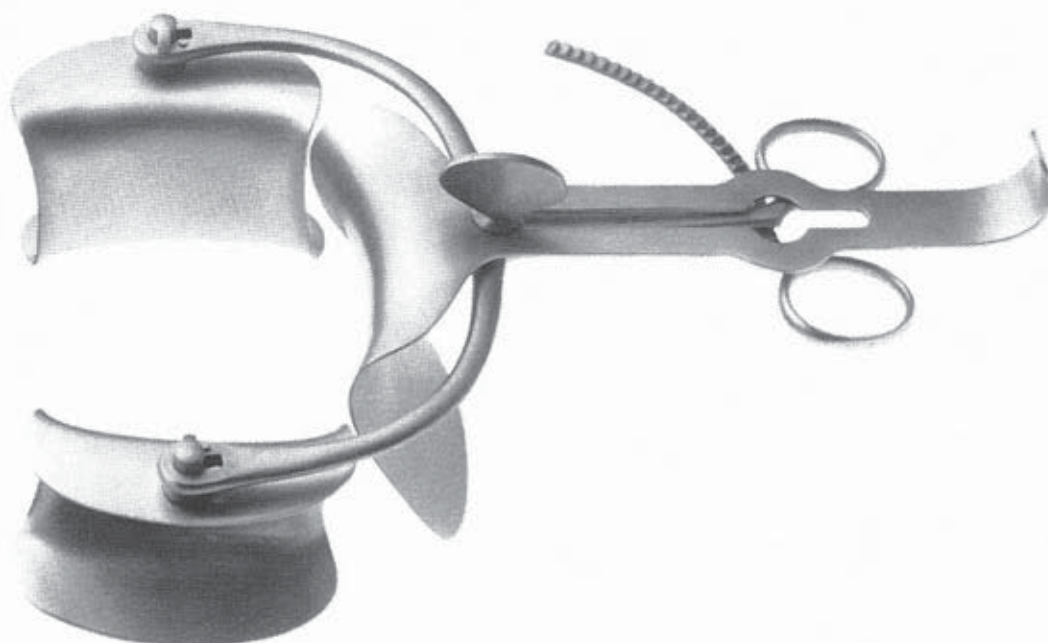

COTTE - branches démontables
pour césarienne

EC 205 01 compas seul - 200 mm - écartement 125 mm

EC 205 02 compas seul - 280 mm - écartement 230 mm

		largeur	profondeur
EC 205 03	valve latérale	50 mm	40 mm
EC 205 04	valve latérale	80 mm	45 mm
EC 205 05	valve latérale	80 mm	55 mm
EC 205 06	valve médiane	75 mm	85 mm



ECARTEURS ABDOMINAUX

DENIS BROWN (cadres complets voir page suivante)



EC 207 02 cadre 180 x 140 mm
 EC 207 03 cadre 255 x 180 mm



EC 207 04 valve à crochet



EC 207 05 valve 13 x 13 mm

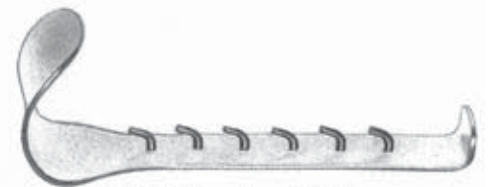

EC 207 06 valve 38 x 38 mm



EC 207 07 valve 13 x 13 mm

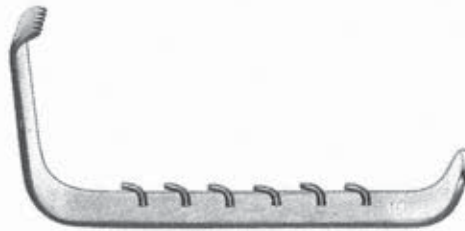

EC 207 08 valve 19 x 64 mm



EC 207 09 valve 19 x 64 mm orientable



ECARTEURS ABDOMINAUX

DENIS BROWN

EC 207 01	ECARTEUR COMPLET PETIT MODELE COMPRENANT :		
	1 cadre	180 x 140 mm	EC 207 02
	2 valves	13 x 13 mm	EC 207 05
	4 valves	38 x 38 mm	EC 207 06
	4 valves	13 x 13 mm	EC 207 07
	4 valves	19 x 64 mm	EC 207 08

EC 207 16	ECARTEUR COMPLET GRAND MODELE COMPRENANT :		
	1 cadre	255 x 180 mm	EC 207 03
	4 valves à crochet		EC 207 04
	4 valves	38 x 38 mm	EC 207 06
	4 valves	13 x 13 mm	EC 207 07
	4 valves	19 x 64 mm	EC 207 08
	1 valve	19 x 64 mm orientable	EC 207 09

ILLUSTRATIONS DES MODELES PAGE PRECEDENTE 206

ECARTEURS ABDOMINAUX

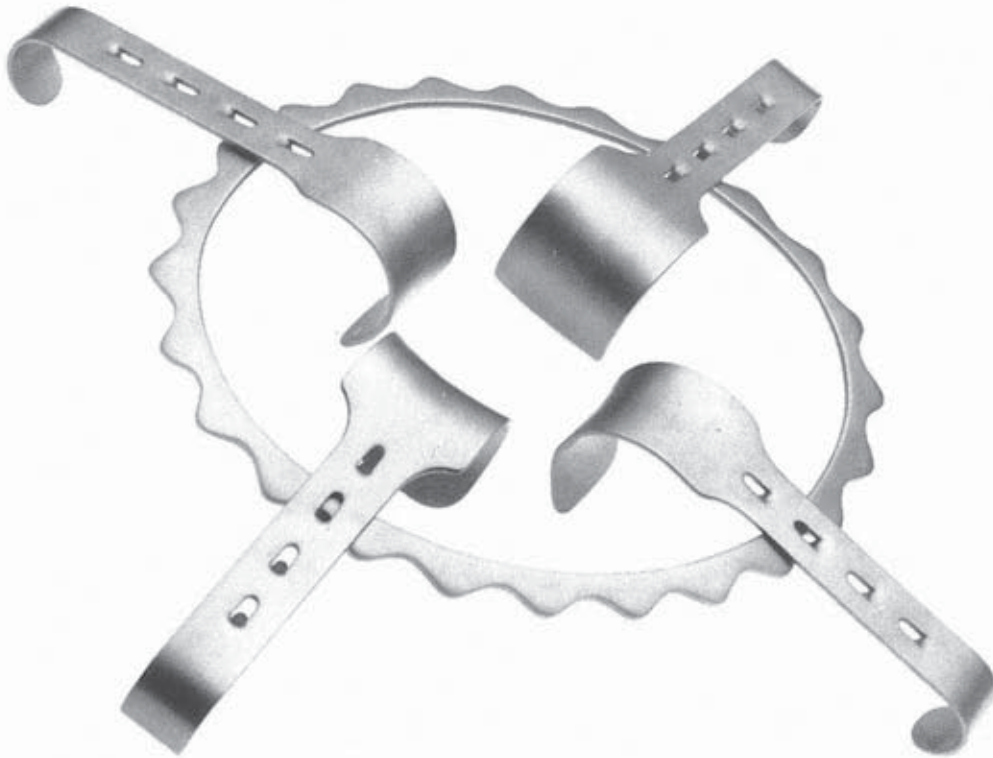

DENIS BROWN - modèle enfant

EC 208 01 COMPLET COMPRENANT :

1 cadre 180 x 150 mm

EC 208 02

2 valves largeur 35 mm - profondeur 40 mm

EC 208 03

2 valves largeur 30 mm - profondeur 40 mm

EC 208 04



ECARTEURS ABDOMINAUX



GOSSET à crémaillère

	Longueur		
	Totale	largeur	Profondeur
EC 209 01	150 mm	30 mm	35 mm
EC 209 02	200 mm	45 mm	60 mm
EC 209 03	300 mm	45 mm	60 mm



GOSSET sans crémaillère

	Longueur		
	Totale	largeur	Profondeur
EC 209 04	150 mm	30 mm	35 mm
EC 209 05	200 mm	45 mm	60 mm
EC 209 06	300 mm	45 mm	60 mm



Valve médiane de RICARD

	largeur	Profondeur
EC 215 06	70 mm	50 mm
EC 215 07	80 mm	80 mm
EC 215 08	100 mm	80 mm
EC 215 09	120 mm	100 mm

Références : (identiques à la page 215)



EC 209 07 support coulisse pour valve médiane

ECARTEURS ABDOMINAUX

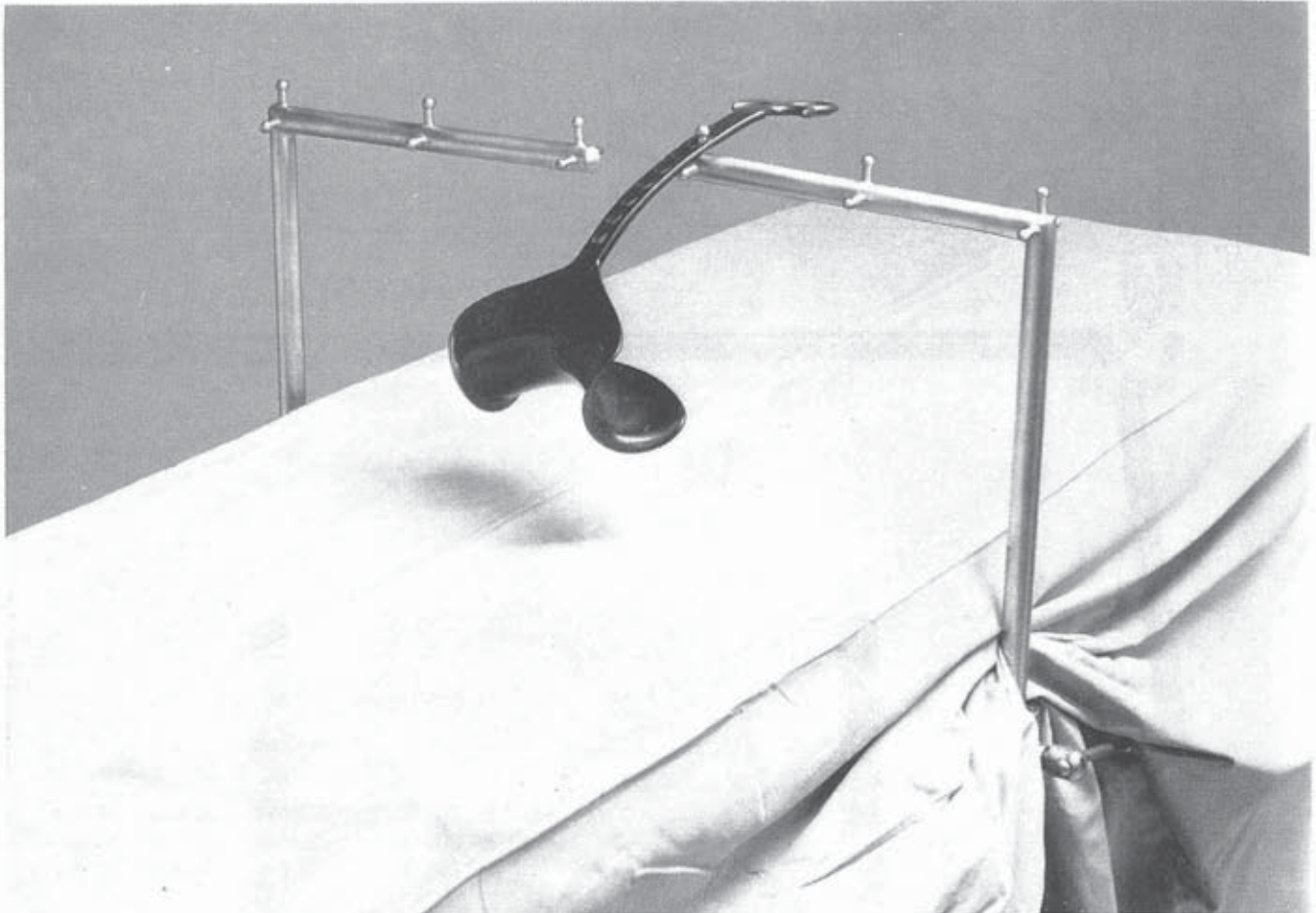

HAUTEFEUILLE
écarteur sus-pubien ou sous-sternal

EC 210 01 paire de piquets

valve revêtement noir antireflet

EC 210 02 80 mm

EC 210 03 100 mm

EC 210 04 120 mm

ECARTEURS ABDOMINAUX

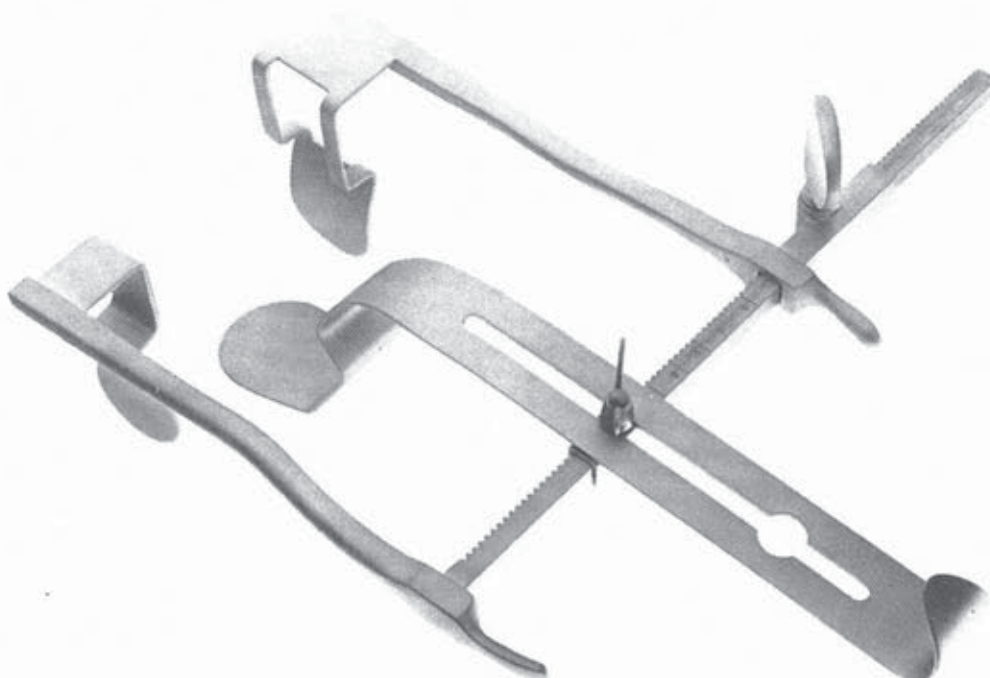

HRYNTSCHAK - écarteur pour prostatectomie

		ouverture	valves latérales	valve médiane
EC 211 01	adulte	115 mm	35 x 80 mm	40 x 90 mm
EC 211 02	enfant	85 mm	18 x 45 mm	25 x 60 mm

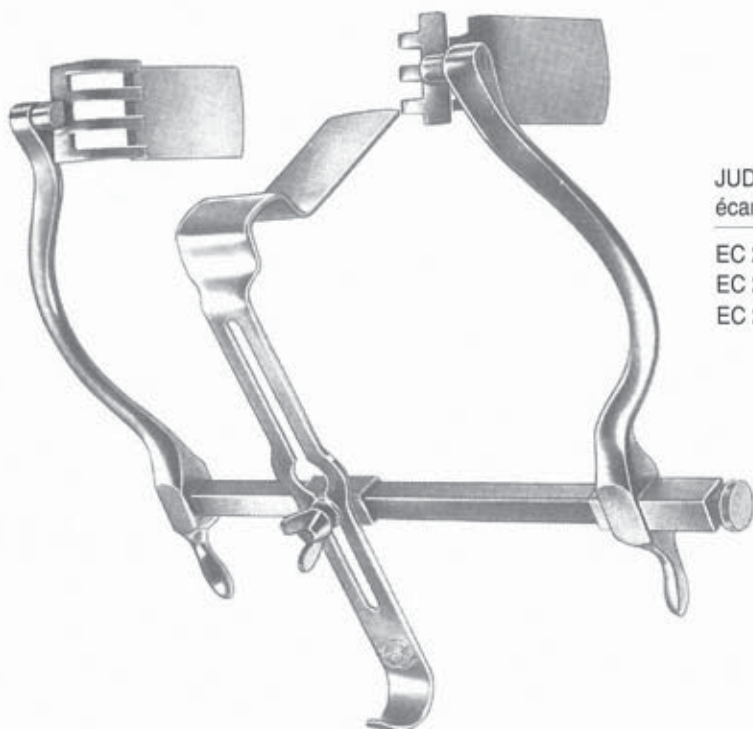

JUDD - MASSON
écarteur pour prostatectomie

EC 211 03	écarteur complet			
EC 211 04	valves latérales	25 x 67 mm		
EC 211 05	valve médiane	25 x 75 mm		

ECARTEURS ABDOMINAUX



KIRSCHNER

EC 212 01 ECARTEUR COMPLET FIXE COMPRENANT :

1 cadre fixe	250 x 250 mm		EC 212 02
2 valves	largeur 55 mm	profondeur 40 mm	EC 212 03
2 valves	largeur 65 mm	profondeur 50 mm	EC 212 04

EC 212 05 ECARTEUR COMPLET PLIANT COMPRENANT :

1 cadre pliant	250 x 250 mm		EC 212 06
2 valves	largeur 55 mm	profondeur 40 mm	EC 212 03
2 valves	largeur 65 mm	profondeur 50 mm	EC 212 04

valves

largeur x profondeur

EC 212 03	55 x 40 mm
EC 212 04	65 x 50 mm
EC 212 07	80 x 65 mm
EC 212 08	80 x 80 mm
EC 212 09	90 x 65 mm
EC 212 10	90 x 90 mm



1/1



ECARTEURS ABDOMINAUX

LEGUEU
écarteur vésical

EC 213 01 COMPLET COMPRENANT :
1 paire valves latérales 60 x 28 mm
1 valve médiane 32 x 70 mm

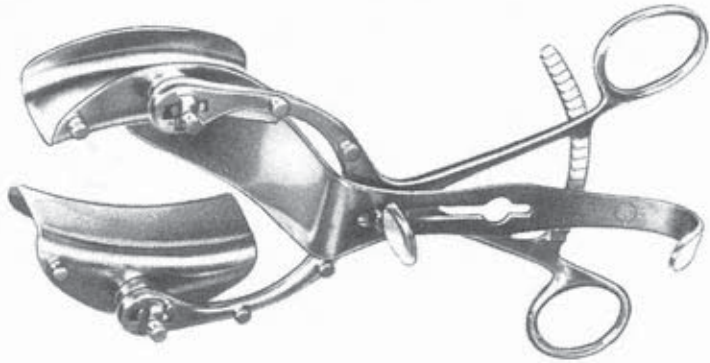



ECARTEURS ABDOMINAUX

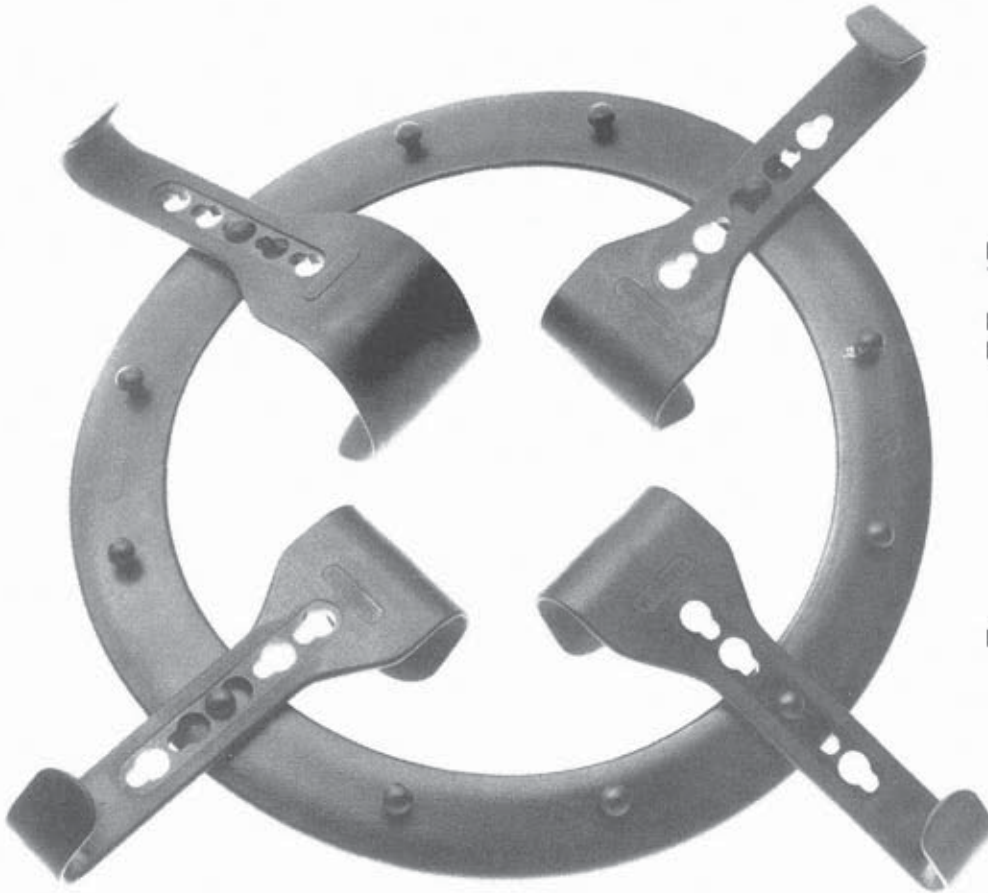

RADIOTRSPARENT

- cadre seul Ø 255 mm
- EC 214 01 4 boutons de fixation
- EC 214 02 12 boutons de fixation

1/1

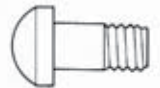

- EC 214 03 sachet de 20 boutons de rechange



- valve
- largeur x profondeur
- EC 214 04 65 mm x 45 mm
- EC 214 05 65 mm x 75 mm



- valve à foie
- largeur x profondeur
- EC 214 06 45 mm x 155 mm

ECARTEURS ABDOMINAUX

RICARD

EC 215 01 compas seul 180 mm

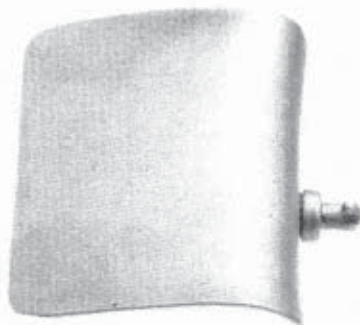
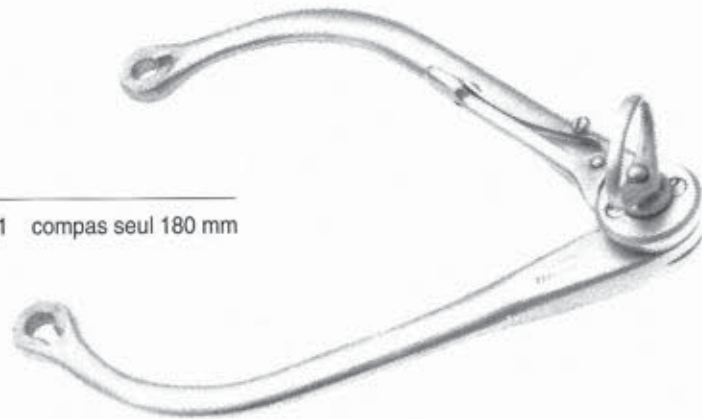

Valve latérale - largeur - profondeur (1 unité)

- EC 215 02 70 x 50 mm
- EC 215 03 80 x 80 mm
- EC 215 04 100 x 80 mm
- EC 215 05 120 x 100 mm

Valve médiane - largeur - profondeur

- EC 215 06 70 x 50 mm
- EC 215 07 80 x 80 mm
- EC 215 08 100 x 80 mm
- EC 215 09 120 x 100 mm

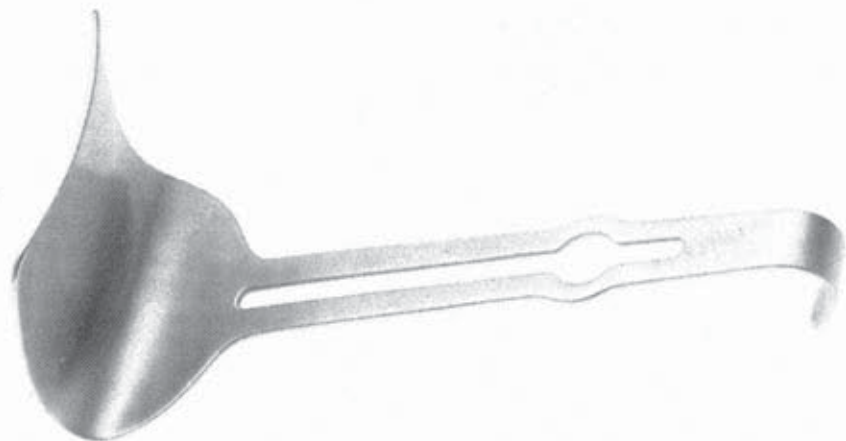



ECARTEURS ABDOMINAUX

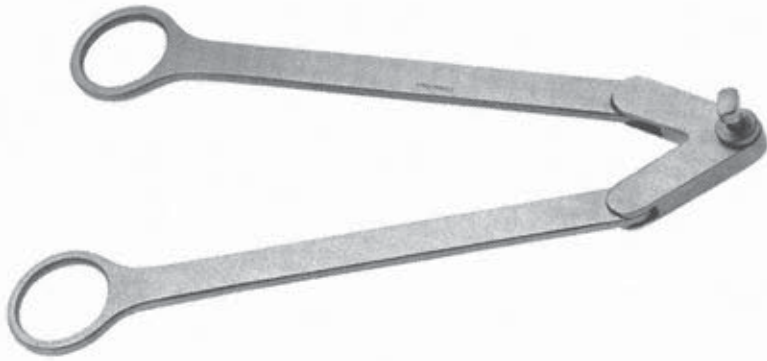

ROCHARD
EC 216 01 compas seul



Valve suspubienne	
	largeur
EC 216 02	80 mm
EC 216 03	100 mm
EC 216 04	120 mm



ECARTEURS ABDOMINAUX

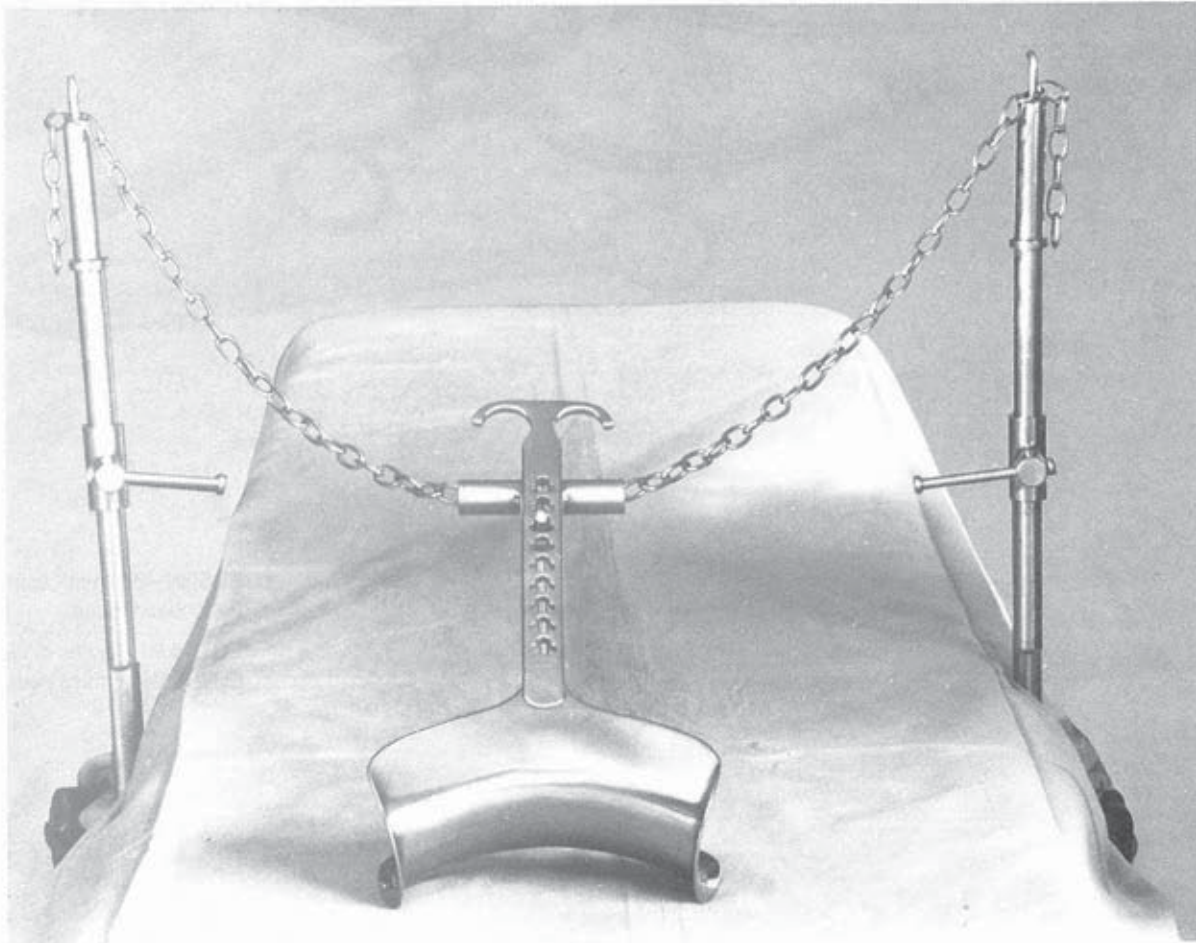

TOUPET

EC 217 01 paire de piquets avec porte-piquets

EC 217 02 curseur

EC 217 03 chainette (le mètre)



ECARTEURS AUTOSTATIQUES



ADSON - 200 mm - courbe
profondeur 20 mm

EC 218 01 griffes mousses - voir référence 222 04
EC 218 02 griffes pointues

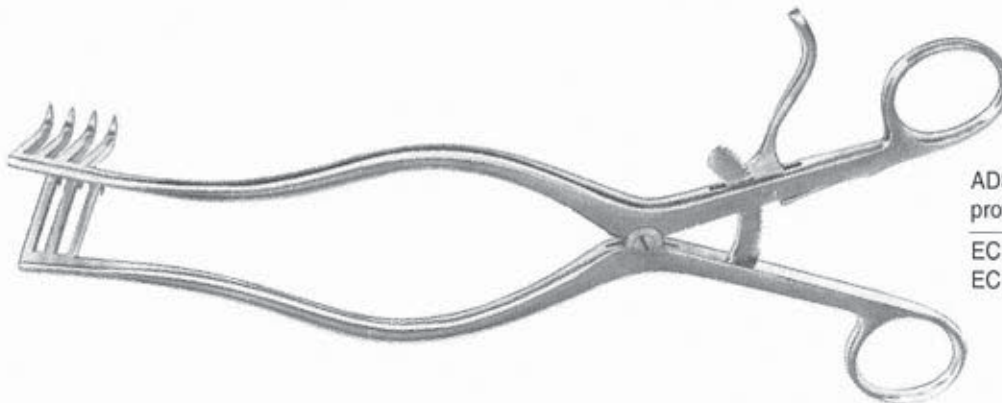

ADSON - 270 mm - courbe
profondeur 35 mm

EC 218 03 griffes mousses
EC 218 04 griffes pointues



ADSON - BECKMANN - 320 mm

	largeur x profondeur			
	25 x 25 mm	25 x 32 mm	25 x 38 mm	25 x 45 mm
griffes mousses	EC 218 05	EC 218 06	EC 218 07	EC 218 08
griffes pointues	EC 218 09	EC 218 10	EC 218 11	EC 218 12

ECARTEURS AUTOSTATIQUES



ALM

	griffes mousses	griffes pointues
70 mm	EC 219 01	EC 219 02
100 mm	EC 219 03	EC 219 04

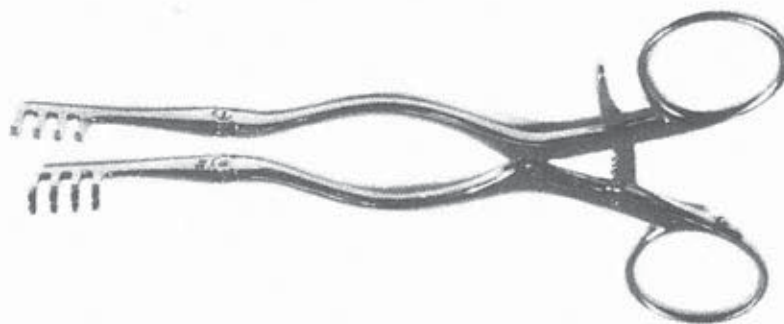

BECKMANN - griffes mousses

		profondeur
EC 219 05	140 mm	10 mm
EC 219 06	170 mm	12 mm
EC 219 07	210 mm	15 mm

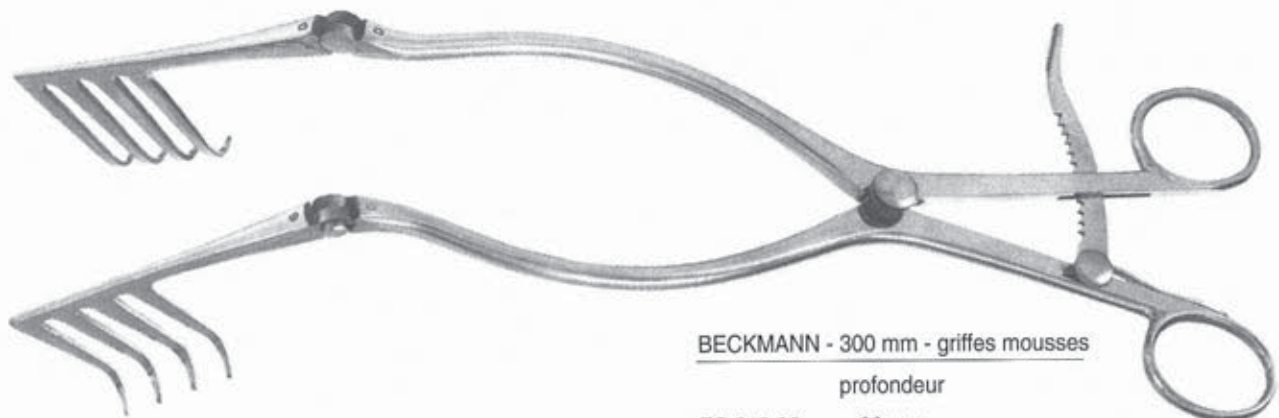

BECKMANN - 300 mm - griffes mousses

	profondeur
EC 219 08	20 mm
EC 219 09	30 mm
EC 219 10	50 mm



ECARTEURS AUTOSTATIQUES

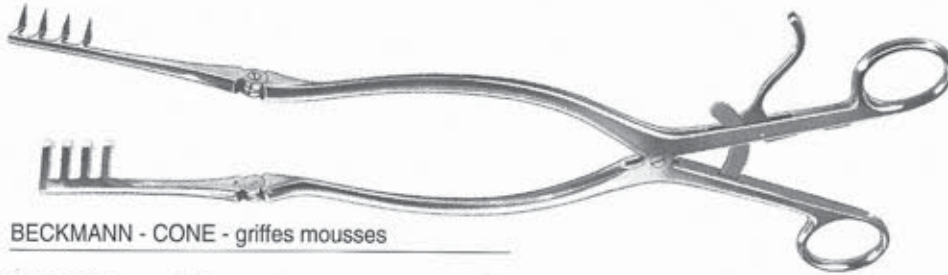

BECKMANN - CONE - griffes mousses

EC 220 01	140 mm		
EC 220 02	170 mm		
EC 220 03	210 mm		
EC 220 04	300 mm	profondeur	20 mm
EC 220 05	*	*	30 mm
EC 220 06	*	*	50 mm

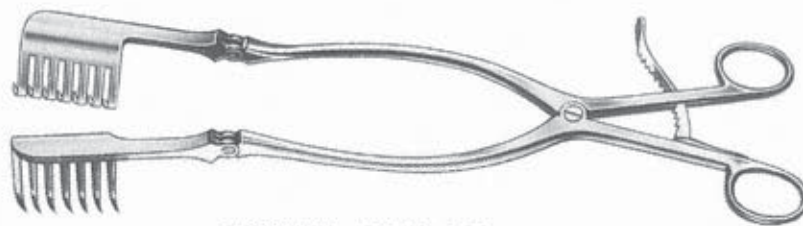

BECKMANN - EATON - 330 mm
profondeur 47 mm

- EC 220 07 griffes mousses
- EC 220 08 griffes pointues



BECKMANN - STILLE - 330 mm
profondeur 35 mm

- EC 220 09 griffes mousses
- EC 220 10 griffes pointues



ECARTEURS AUTOSTATIQUES



CHARNLEY - 300 mm
pour la hanche
EC 221 01 griffes horizontales

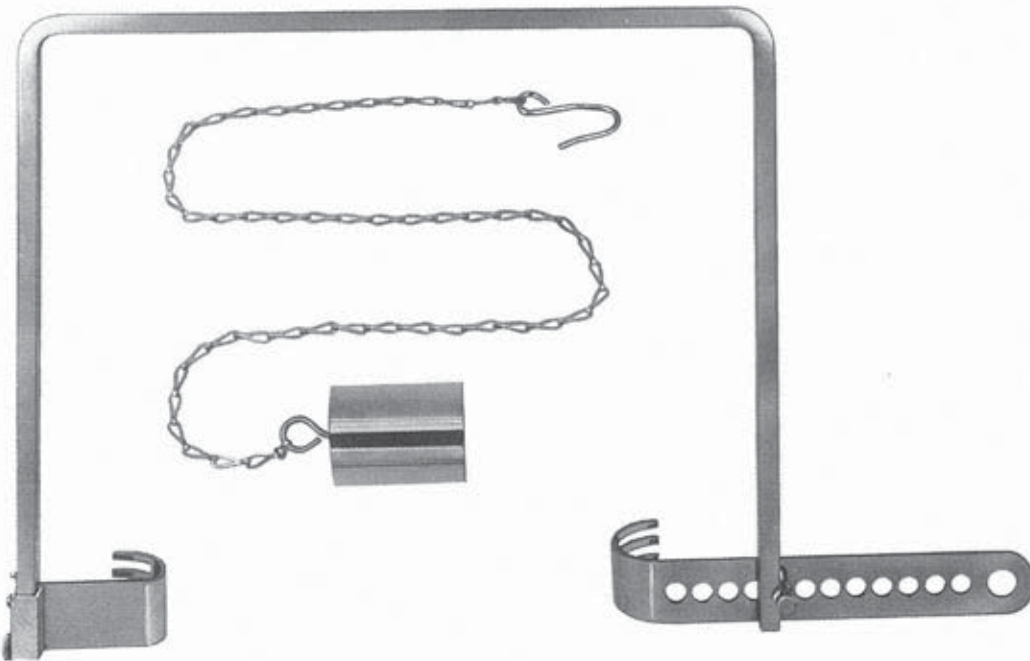

CHARNLEY - Cadre complet grand modèle largeur du cadre 310 mm
EC 221 02 profondeur des valves 45 mm



CLOWARD - 130 mm - écarteur à tissus
profondeur 13 mm - griffes mousses
EC 221 03 1 x 1 griffes
EC 221 04 3 x 3 griffes

ECARTEURS AUTOSTATIQUES



DAVIS - 100 mm
profondeur 12 mm

EC 222 01 griffes mousses
EC 222 02 griffes pointues

DOS D'ANE
griffes mousses

EC 222 03 170 mm

EC 222 04 200 mm



FINSEN - écarteur à graisse

	50 mm	70 mm
griffes mousses	EC 222 05	EC 222 06
griffes pointues	EC 222 07	EC 222 08



FINSEN - 70 mm
réglable

EC 222 09 griffes mousses
EC 222 10 griffes pointues

ECARTEURS AUTOSTATIQUES

GELPI
 EC 223 01 130 mm
 EC 223 02 190 mm

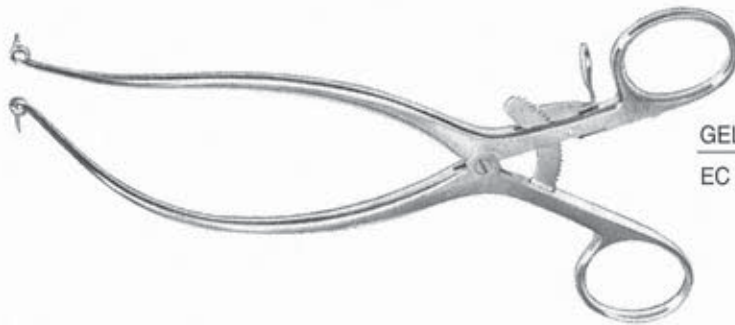
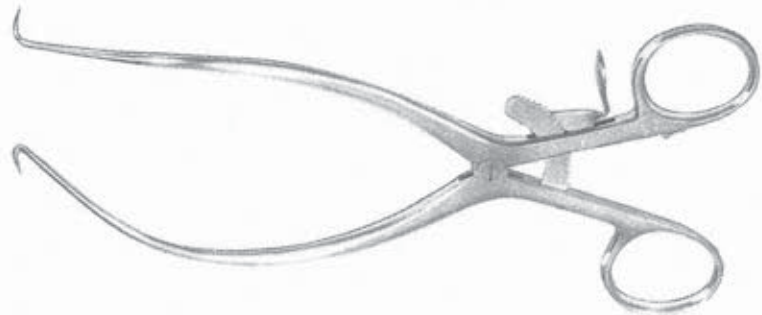

GELPI - 190 mm
 EC 223 03 avec butées

GELPI - SELETZ
 EC 223 04 150 mm coudé

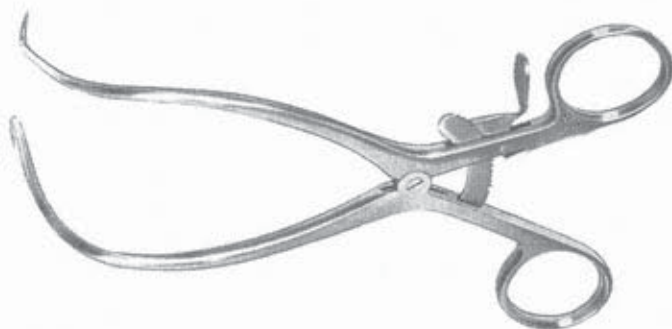

HEISS - 100 mm
 EC 223 05 griffes mousses



ECARTEURS AUTOSTATIQUES

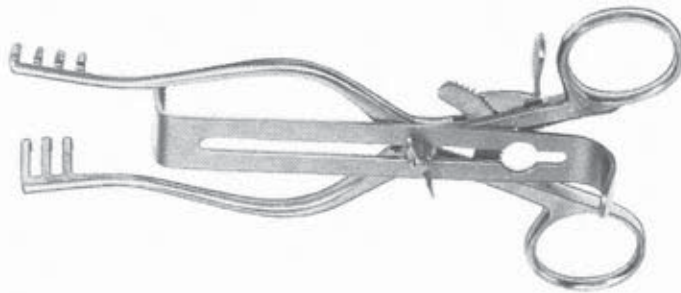

HENLEY - 165 mm
écarteur vasculaire

EC 224 01 complet avec 3 valves médianes



1/1 valves médiane largeur 16 mm
profondeur

EC 224 02 19 mm

EC 224 03 25 mm

EC 224 04 32 mm

EC 224 07 écarteur seul sans les valves



ECARTEURS AUTOSTATIQUES

JANSEN - DAVIS 100 mm
griffes mousses



EC 225 02 4 x 4 griffes profondeur 20 mm

JOLL - écarteur à goitre
EC 225 04



MAC KEE - 230 mm
pour la hanche - griffes mousses

EC 225 05 profondeur 50 mm
EC 225 06 profondeur 60 mm





ECARTEURS AUTOSTATIQUES



MISKIMON - 220 mm
profondeur 32 mm

EC 226 01 griffes mousses

EC 226 02 griffes pointues

MUNRO - 165 mm
valves pivotantes

EC 226 03 griffes mousses

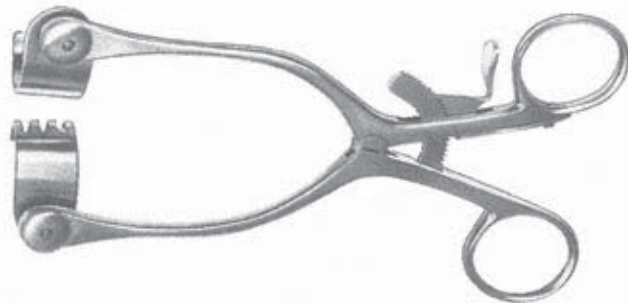

1/1

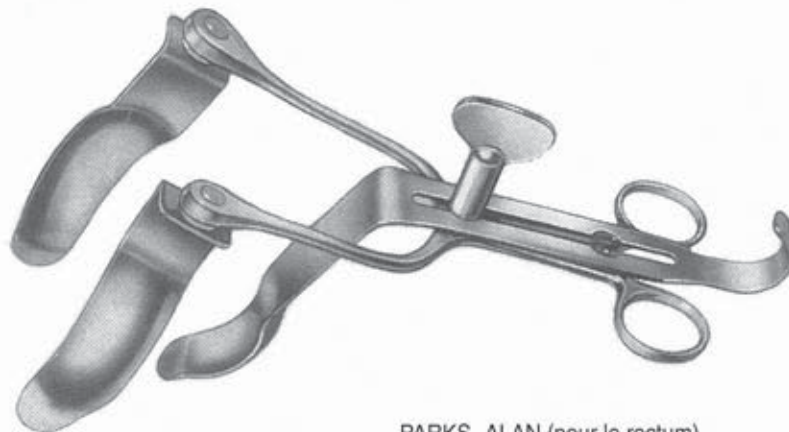

PARKS- ALAN (pour le rectum)

EC 226 04 complet avec 2 paires de valves
latérales et 1 valve médiane



ECARTEURS AUTOSTATIQUES



RIGBY - 190 mm

largeur x profondeur

EC 227 02 16 x 70 mm

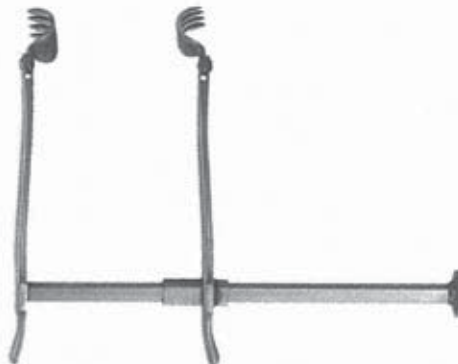

VACHER - mastoidien

EC 227 03 ouverture 80 mm



ECARTEURS AUTOSTATIQUES



WEITLANER

		griffes mousses	griffes pointues
105 mm	2 x 3 griffes	EC 228 01	EC 228 02
130 mm	3 x 4 griffes	EC 228 03	EC 228 04
165 mm	3 x 4 griffes	EC 228 05	EC 228 06
200 mm	3 x 4 griffes	EC 228 07	EC 228 08
250 mm	3 x 4 griffes	EC 228 09	EC 228 10
130 mm	5 x 6 griffes	EC 228 11	EC 228 12
250 mm	5 x 6 griffes	EC 228 13	EC 228 14

WEITLANER - WULLSTEIN - 130 mm

EC 228 15 griffes mousses

EC 228 16 griffes pointues

(longueur 170 et 200 mm
voir écarteur DOS D'ANE page 222)





ECARTEURS AUTOSTATIQUES POUR LE RACHIS



SYSTEME DE VERROUILLAGE RAPIDE
A BILLES

CLOWARD - 150 mm
sans valves - pour rachis cervical
EC 230 01 ouverture 60 mm

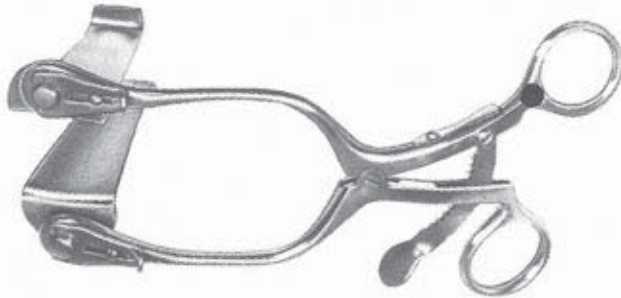

CLOWARD - 250 mm
sans valves - pour rachis cervical
EC 230 02 ouverture 115 mm

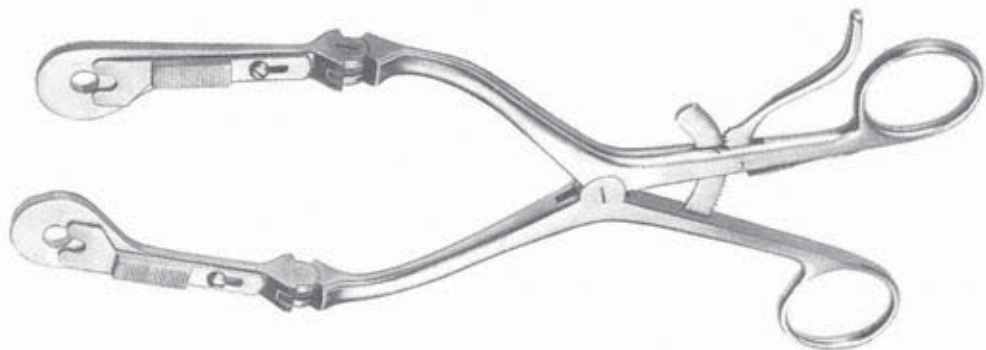

CLOWARD - 200 mm
sans valves - pour rachis lombaire
EC 230 03 ouverture 80 mm

ECARTEURS AUTOSTATIQUES POUR LE RACHIS



SYSTEME DE VERROUILLAGE RAPIDE
A BILLES

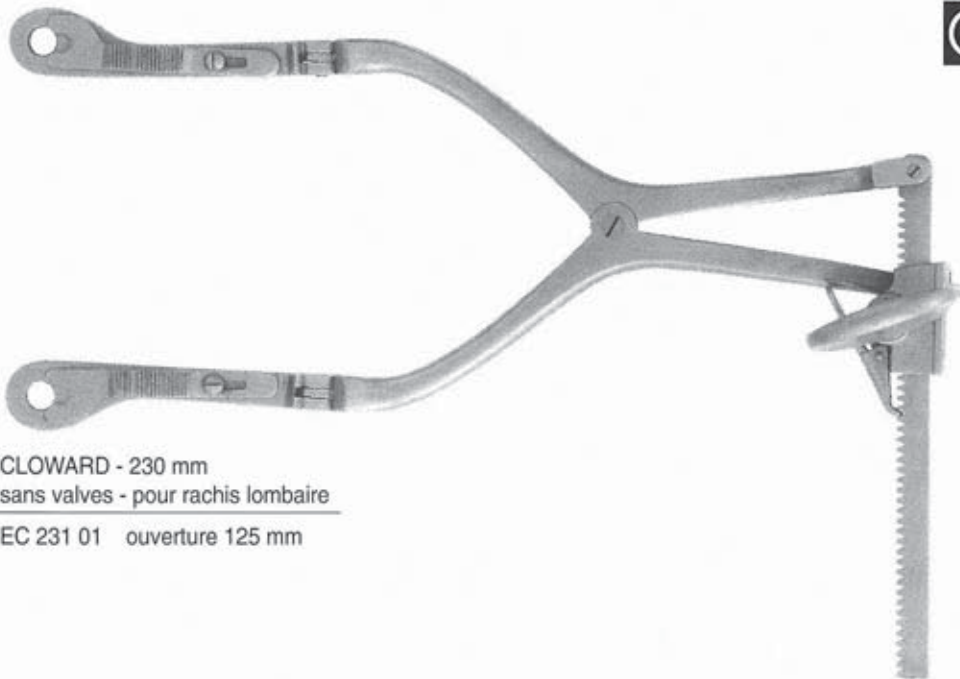

CLOWARD - 230 mm
sans valves - pour rachis lombaire

EC 231 01 ouverture 125 mm

CLOWARD valve seule,

profondeur :

à griffes

sans griffes

EC 231 02



40 mm



EC 231 03

EC 231 04



45 mm



EC 231 05

EC 231 06



50 mm



EC 231 07

EC 231 08



55 mm



EC 231 09

EC 231 10



60 mm



EC 231 11

CLOWARD
valve seule multi-griffes,

profondeur :



50 mm

EC 231 12

64 mm

EC 231 13

ECARTEURS AUTOSTATIQUES POUR LE RACHIS

ECARTEURS POUR LES CORPS VERTEBRAUX

CLOWARD CERVICAL - 150 mm
EC 232 01 ouverture 20 mm

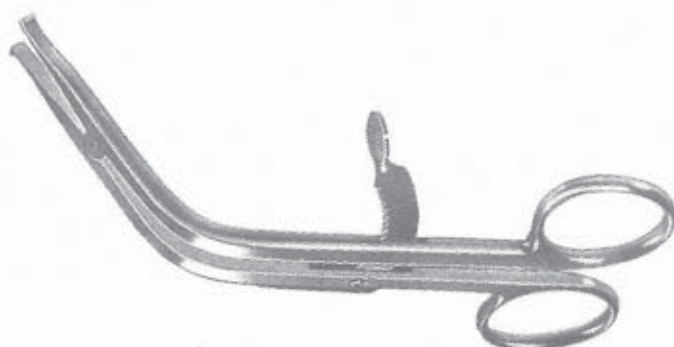
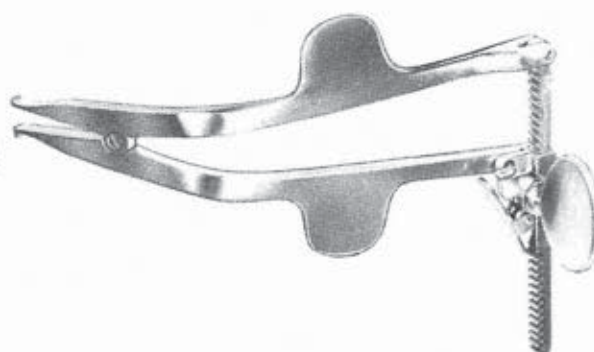

CLOWARD CERVICAL - 160 mm
EC 232 02 ouverture 15 mm

CLOWARD CERVICAL
modèle lourd
EC 232 03 ouverture 20 mm, bras 80 mm

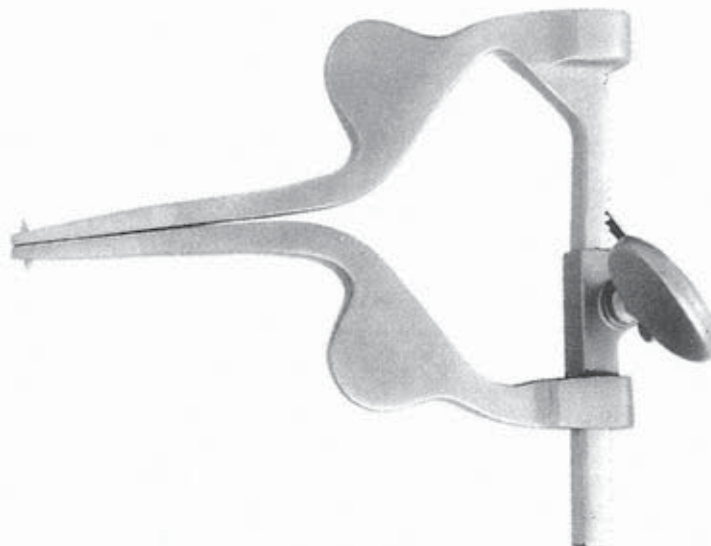

ECARTEURS AUTOSTATIQUES POUR LE RACHIS

ECARTEURS POUR LES CORPS VERTEBRAUX

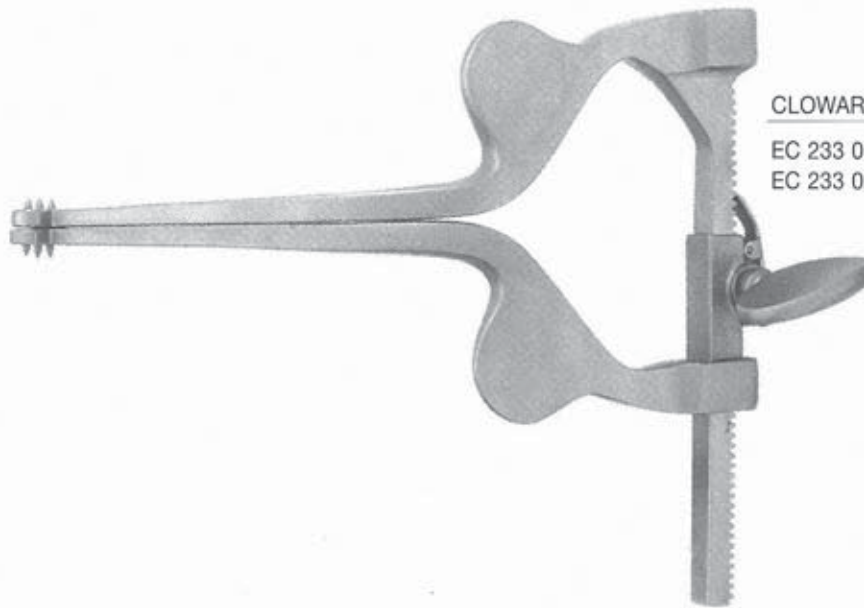

CLOWARD LOMBAIRE

EC 233 01 ouverture 38 mm, bras 105 mm

EC 233 02 ouverture 28 mm, bras 120 mm

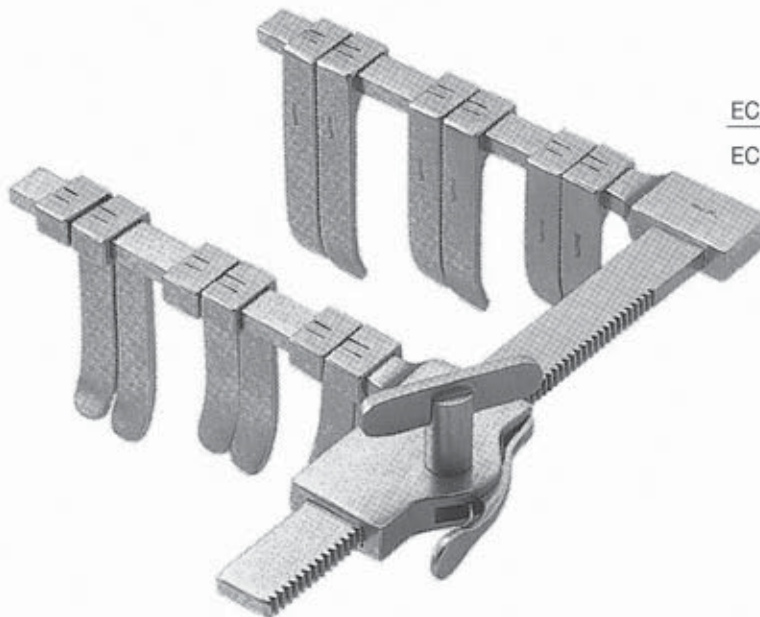

ECARTEUR LILLOIS

EC 233 03 - 6 paires de valves



ECARTEURS AUTOSTATIQUES POUR LE RACHIS

ECARTEURS POUR LES CORPS VERTEBRAUX

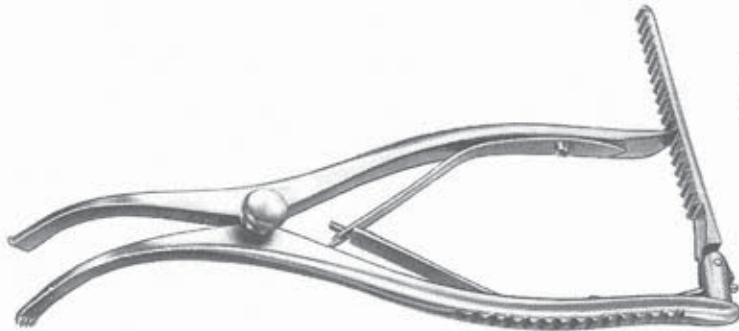

INGE - 160 mm cervical

EC 234 01 écartement 38 mm

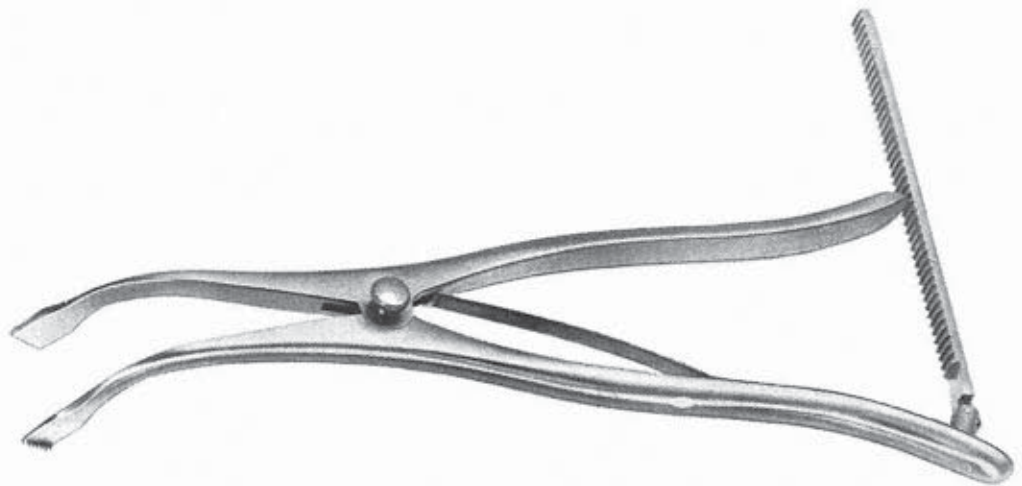

INGE - 250 mm lombaire

EC 234 02 écartement 50 mm



INGE - MEARY - 260 mm lombaire
à crémaillère

EC 234 03 écartement 40 mm



ECARTEURS AUTOSTATIQUES POUR LE RACHIS

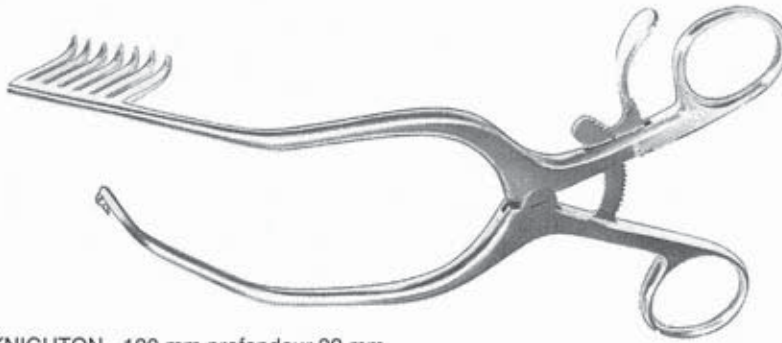

KNIGHTON - 180 mm profondeur 32 mm
pour hémilaminectomie

	mousses	pointues
griffes à droite	EC 235 01	EC 235 02
griffes à gauche	EC 235 03	EC 235 04



MARCKAM MEYERDING - 180 mm
pour hémilaminectomie

	largeur x profondeur	
	25 x 25 mm	25 x 44 mm
valve à droite	EC 235 05	EC 235 06
valve à gauche	EC 235 07	EC 235 08

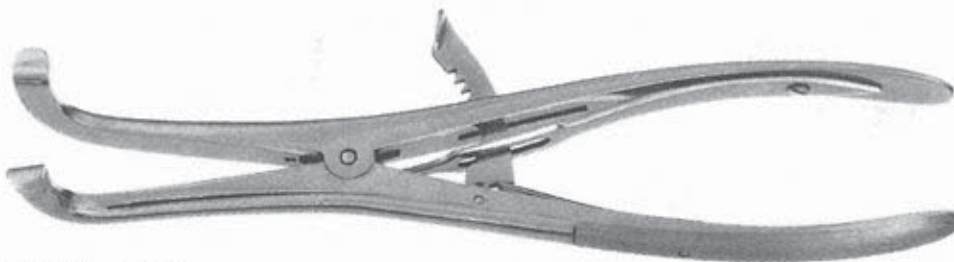

MATHEY - 180 mm
vertébral

EC 235 09 écartement 45 mm



ECARTEURS AUTOSTATISTIQUES POUR LE RACHIS

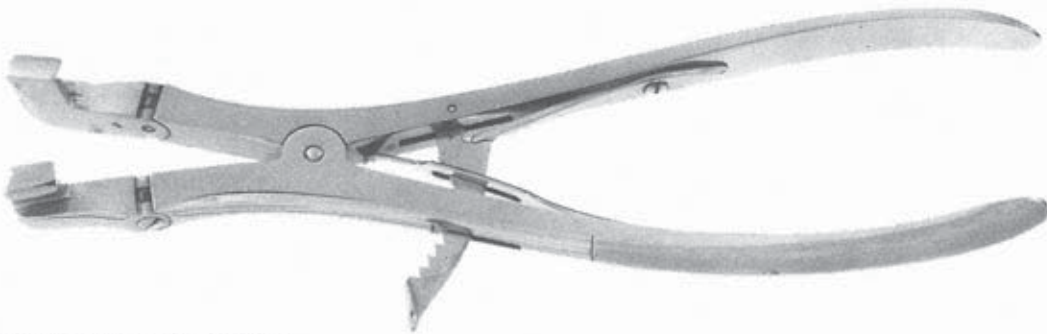

MAURER - 200 mm - vertébral
mors mobiles
EC 236 01 écartement 35 mm

MEYERDING - 200 mm
valves
largeur x profondeur
EC 236 02 19 x 60 mm
EC 236 03 25 x 32 mm
EC 236 04 25 x 54 mm
EC 236 05 25 x 60 mm

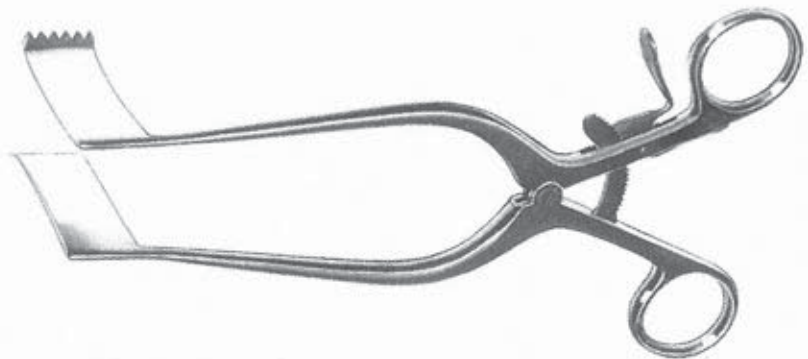

SCOVILLE - HAVERFIELD
EC 236 06 écartement 150 mm
VOIR VALVES PAGE SUIVANTE



ECARTEURS AUTOSTATIQUES POUR LE RACHIS

VALVES POUR ECARTEUR DE SCOVILLE - HAVERFIELD



1/1
profondeur
EC 237 01 50 mm
EC 237 02 75 mm



1/1
avec butée
profondeur
EC 237 03 50 mm
EC 237 04 75 mm

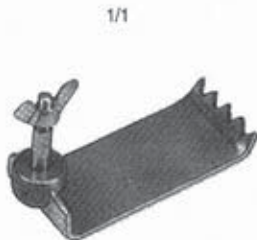

1/1
largeur x profondeur
EC 237 05 25 x 64 mm
EC 237 06 25 x 88 mm
EC 237 07 50 x 64 mm



1/1
largeur x profondeur
EC 237 08 25 x 57 mm
EC 237 09 25 x 75 mm
EC 237 10 25 x 83 mm
EC 237 11 50 x 88 mm



1/1
largeur x profondeur
EC 237 12 25 x 50 mm
EC 237 13 25 x 64 mm
EC 237 14 25 x 75 mm
EC 237 15 25 x 88 mm

1/1
largeur x profondeur
EC 237 16 25 x 100 mm
EC 237 17 38 x 64 mm
EC 237 18 38 x 75 mm
EC 237 19 38 x 88 mm

EC 237 20 50 x 50 mm
EC 237 21 50 x 75 mm
EC 237 22 50 x 100 mm
EC 237 23 64 x 75 mm



1/1
largeur x profondeur
EC 237 24 38 x 44 mm



1/1
largeur x profondeur
EC 237 25 50 x 48 mm
EC 237 26 57 x 80 mm
EC 237 27 64 x 64 mm



ECARTEURS THORACIQUES

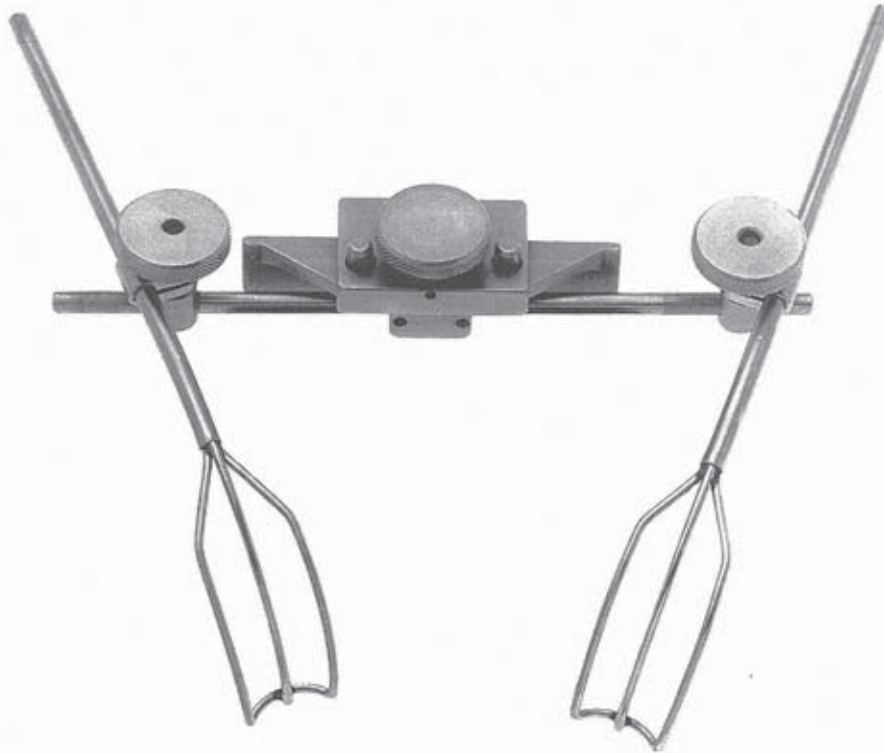

Ecarteur à mitrale du professeur DE RIBEROLLES

EC 239 01

- S'adapte sur l'écarteur de DUBOST.
- Facilité de la chirurgie plastique de l'appareil valvulaire mitral.
- Facilité de l'abord de l'orifice mitral au cours de réinterventions lorsque les adhérences ventriculaires n'ont pas été libérées.
- Libère les mains de l'aide placé en face du chirurgien.
- N'est mis en place que pour la durée du geste chirurgical pour lequel il est utile.
- Très souple de réglage pour s'adapter aux diverses conformations thoraciques, ou diverses tailles d'oreillettes gauches.
- Utilisé pour tous les gestes mitraux et parfois pour la tricuspide.

ECARTEURS THORACIQUES

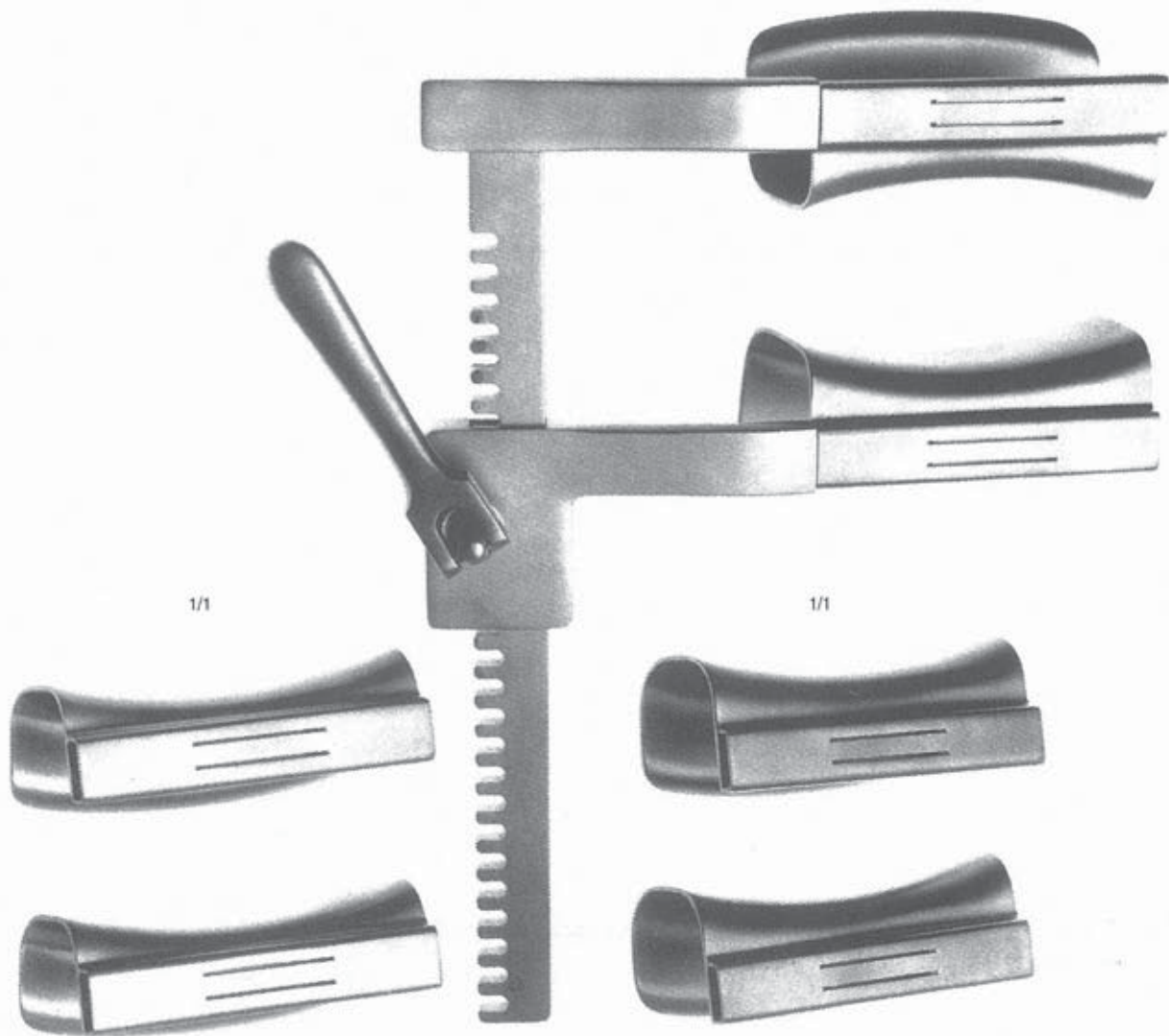

DUBOST
écarteur sternal

EC 240 01 complet avec 3 paires de valves

paire de valves	largeur	profondeur
EC 240 02	100 mm	30 mm
EC 240 03	100 mm	40 mm
EC 240 04	100 mm	50 mm



ECARTEURS THORACIQUES

FINOCHIETTO

référence	modèle	O	P	L	H
EC 241 02	adulte	200 mm	45 mm	65 mm	180 mm
EC 241 03	enfant	165 mm	40 mm	45 mm	130 mm
EC 241 04	nourrisson	80 mm	20 mm	20 mm	75 mm

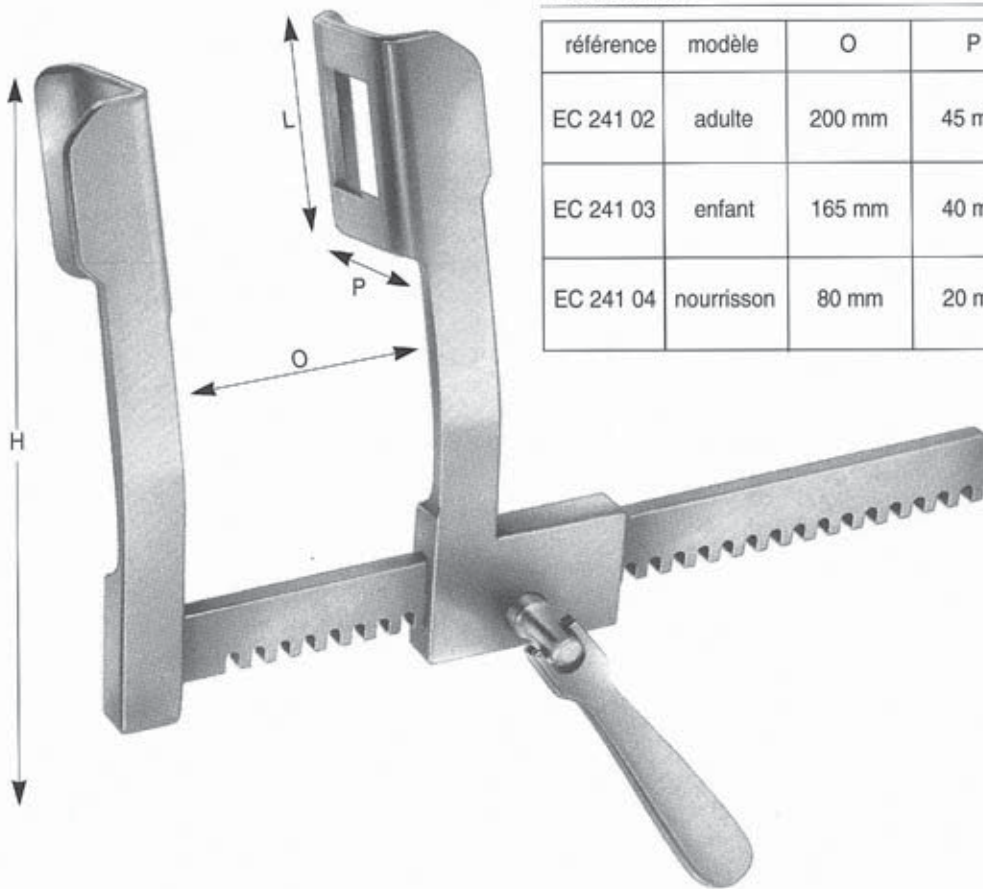

ECARTEURS THORACIQUES

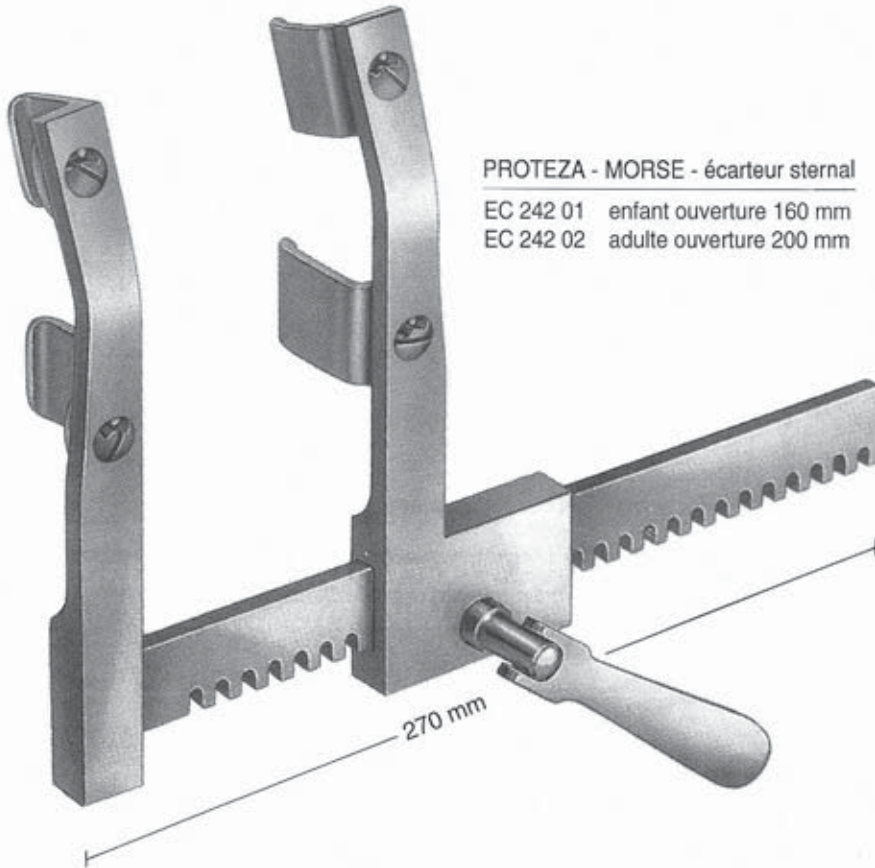

PROTEZA - MORSE - écarteur sternal

EC 242 01 enfant ouverture 160 mm

EC 242 02 adulte ouverture 200 mm

TUFFIER

EC 242 03 valves 46 x 50 mm





ECRASEURS INTESTINAUX

DE MARTEL

- EC 244 01 90 mm
- EC 244 02 110 mm



PINCE DE SERRAGE
A LEVIER

- EC 244 05 250 mm



PAYR

- EC 244 06 150 mm
- EC 244 07 200 mm
- EC 244 08 290 mm
- EC 244 09 350 mm





ELEVATEURS



ADSON - 170 mm



EL 245 01
droit tranchant
largeur 6 mm



EL 245 02
demi courbe mousse
largeur 6 mm



EL 245 03
courbe tranchant
largeur 6 mm



EL 245 04
bisauté
largeur 9 mm



CUSHING - 180 mm
largeur 15 mm

EL 245 05 demi-courbe



1/2

DANIS - 240 mm - cuiller

EL 245 06
largeur 45 mm



KEY - 190 mm - tranchant

	largeur
EL 245 07	6 mm
EL 245 08	12 mm
EL 245 09	20 mm
EL 245 10	25 mm



ELEVATEURS



1/3

LAMBOTTE - 290 mm

EL 246 01 levier simple largeur 25 mm
EL 246 02 levier double largeur 15 et 30 mm

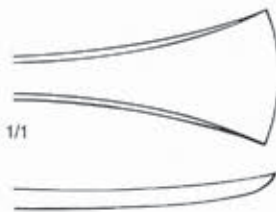

1/1

LANGENBECK - 190 mm - tranchant

EL 246 03 largeur 15 mm



1/1

LANGENBECK - 190 mm - mousse

EL 246 04 largeur 7mm



ETRIERS

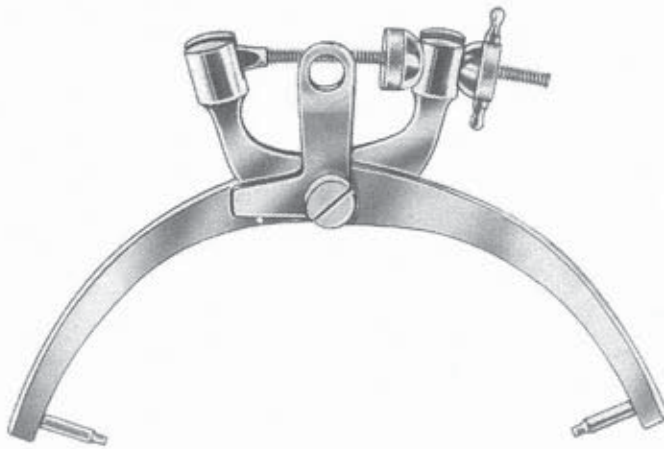

CRUTCHFIELD - ETRIER CRANIEN

- ET 247 01 grand modèle
- ET 247 02 petit modèle

 ET 247 03 jeu de 2 mèches

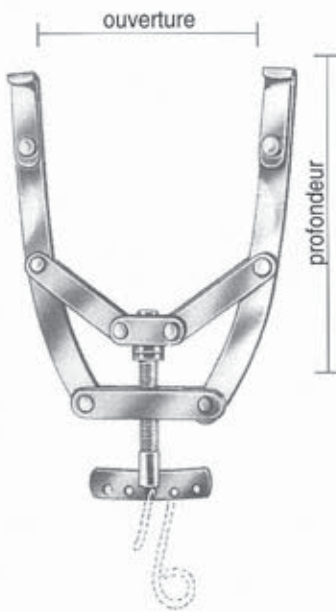

KIRSCHNER AMERICAIN

	ouverture		profondeur
	mini	maxi	
ET 247 04	70 mm	130 mm	130 mm
ET 247 05	70 mm	210 mm	180 mm

KIRSCHNER avec 3 crochets

	ouverture
ET 247 06	90 mm
ET 247 07	115 mm
ET 247 08	135 mm
ET 247 09	155 mm

- ET 247 10 tendeur (non illustré)
- ET 247 11 clé (non illustré)
- ET 247 12 crochet (non illustré)

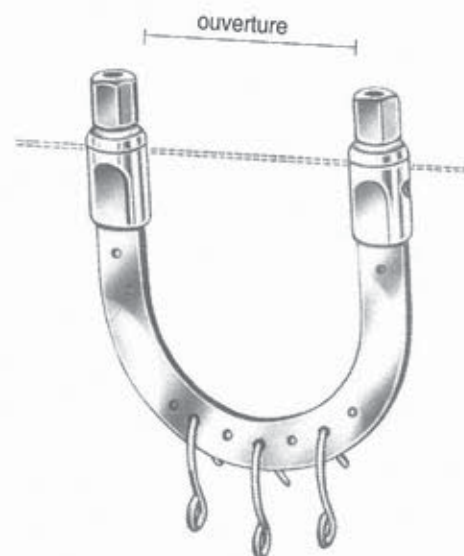



FI

PAGES

FORCEPS OBSTETRICAUX

250 - 253

HYSTEROMETRES

255

LAMES MALLEABLES

256



FILS CERCLAGE
GOUGES
LAMES LAMBOTTE
LEVIER A OS
LEVIER A OS

VOIR
VOIR
VOIR
VOIR
VOIR

SERRE NOEUD
CISEAUX A OS
CISEAUX A OS
ECARTEUR SUR MANCHE
ELEVATEURS



FORCEPS OBSTETRICIQUES

BARTON - 360 mm - Cuiller articulée

FO 250 01

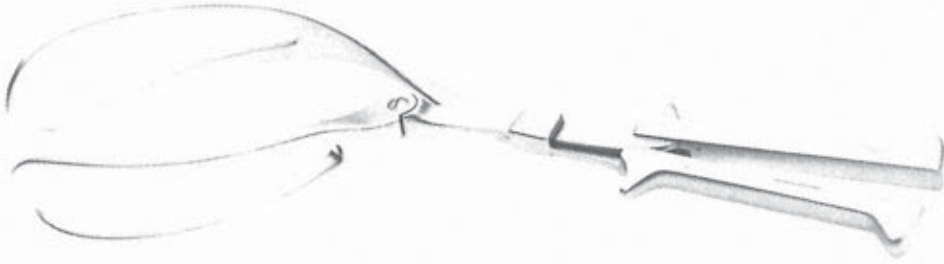

DEMELIN SUZOR - 320 mm

FO 250 02

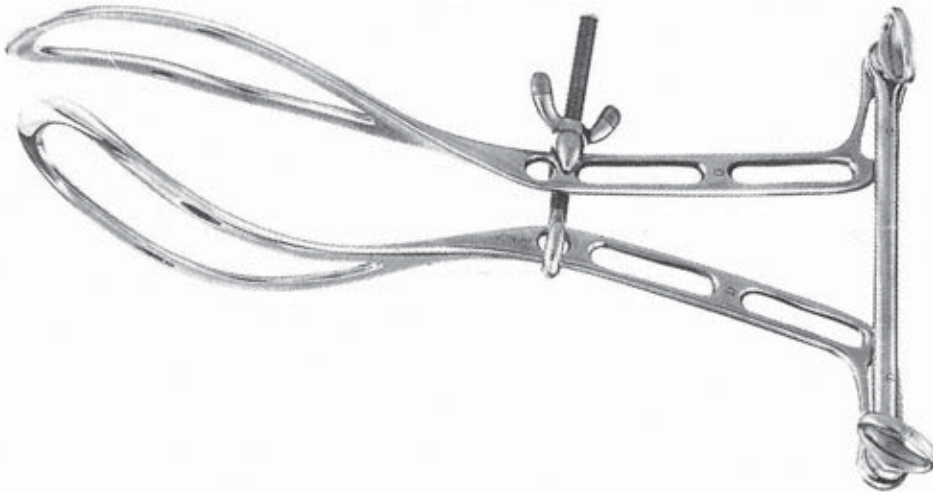

KIELAND - 410 mm

FO 250 03

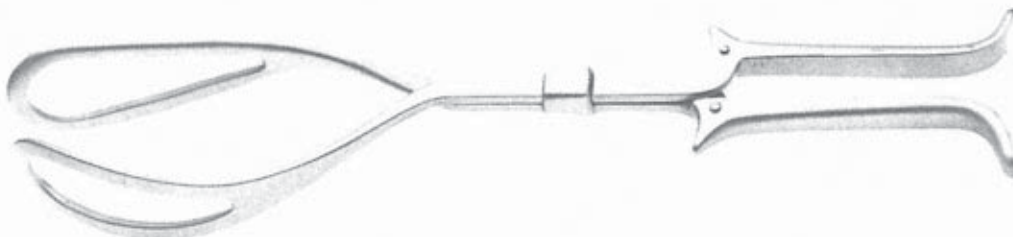



FORCEPS OBSTETRICAUX

KIELAND LUIKART
FO 251 01 400 mm



LUIKART
FO 251 02 400 mm



NAEGLE
FO 251 03 360 mm
FO 251 04 400 mm

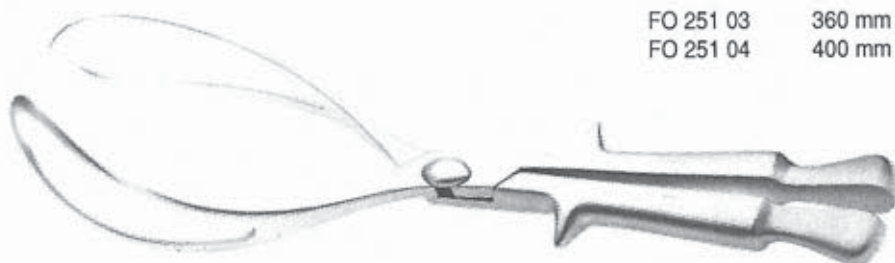

PAJOT
FO 251 05 330 mm





FORCEPS OBSTETRICAUX

SELLHEIM - cuiller

FO 252 01 280 mm



SIMPSON

FO 252 02 230 mm

FO 252 03 300 mm

TARNIER - avec TRACTEUR

FO 252 04 400 mm

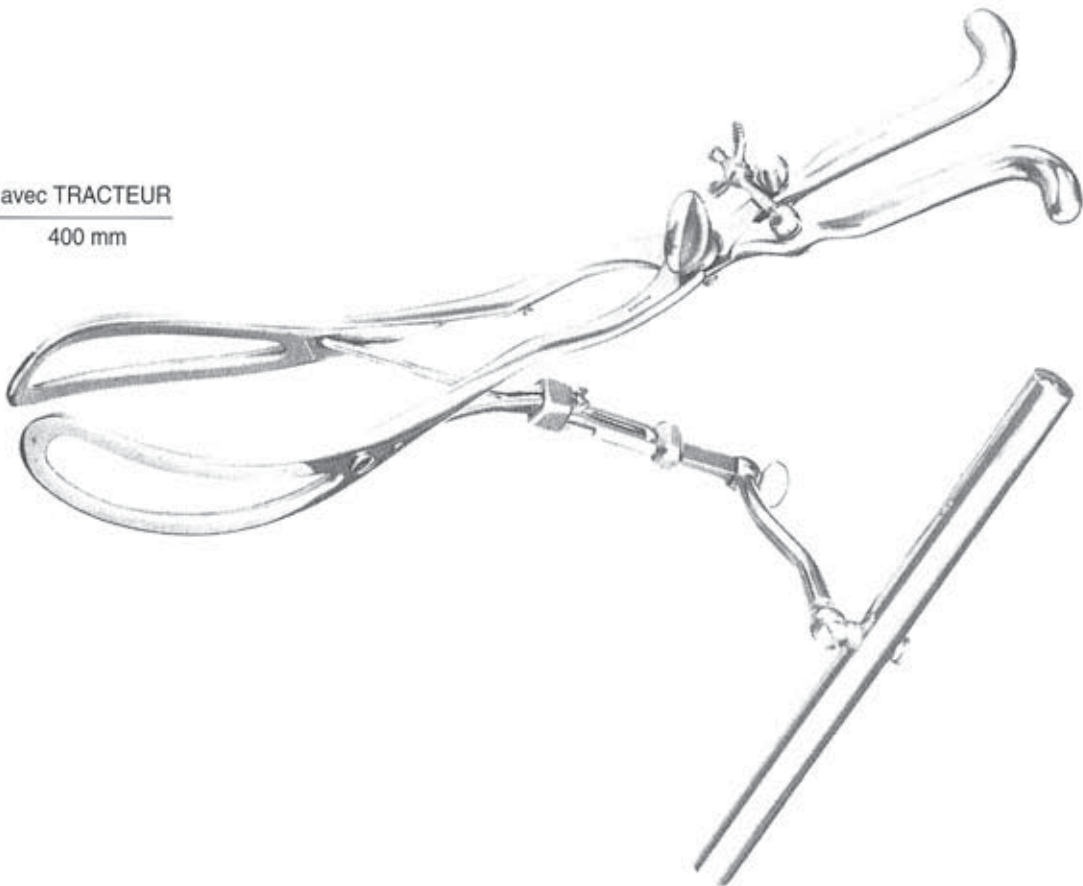



FORCEPS OBSTETRICIAUX

TEISSIER - 310 mm

FO 253 01 paire de spatules
FO 253 02 tracteur seul

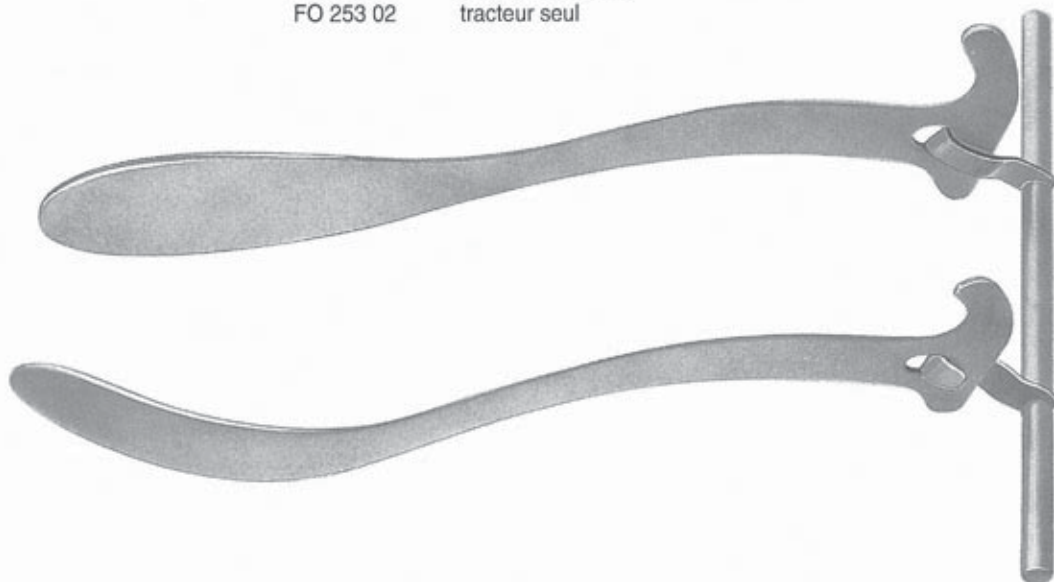

THIERRY - (la paire)

FO 253 03 390 mm
FO 253 04 360 mm

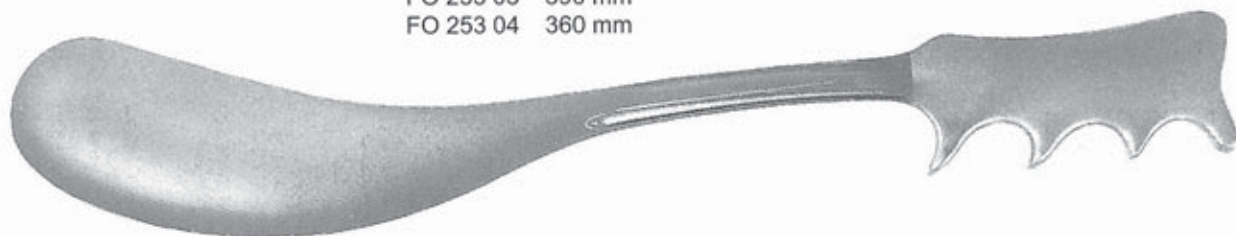



HYSTEROMETRES

SIMS - malléable

HY 255 01 330 mm

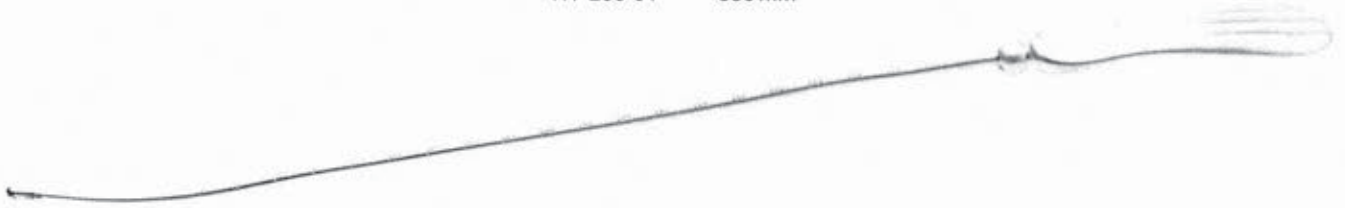

VALLEIX - malléable
avec curseur

HY 255 02 290 mm





LAMES MALLEABLES

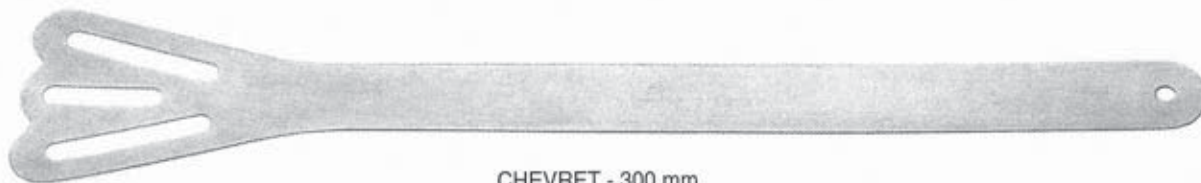

CHEVRET - 300 mm

	largeur
LA 256 01	40 mm
LA 256 02	60 mm
LA 256 03	80 mm



DAVIS - 200 mm

	largeur
LA 256 04	6 mm
LA 256 05	12 mm
LA 256 06	17 mm
LA 256 07	25 mm



LARDENNOIS

	longueur	largeur
LA 256 08	240 mm	25 et 40 mm
LA 256 09	270 mm	25 et 40 mm
LA 256 10	360 mm	30 et 50 mm



POIRIER - 200 mm

	largeur
LA 256 11	18 et 25 mm



M-O

PAGES

MAILLETS 258

MASSES 258

MAIN DE PLOMB 258

MANDRIN 258

OUVRE BOUCHES 260 - 263



OSTEOTOMES

VOIR

CISEAUX A OS



MAILLETS - MASSES - MAIN DE PLOMB - MANDRIN

MAC EVEN TETE SIMPLE - 230 mm

MA 258 01	Ø 25 mm	250 gr.
MA 258 02	Ø 30 mm	350 gr.
MA 258 03	Ø 35 mm	500 gr.
MA 258 04	Ø 40 mm	700 gr.

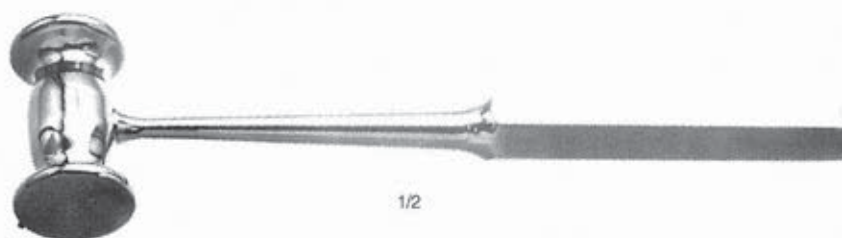
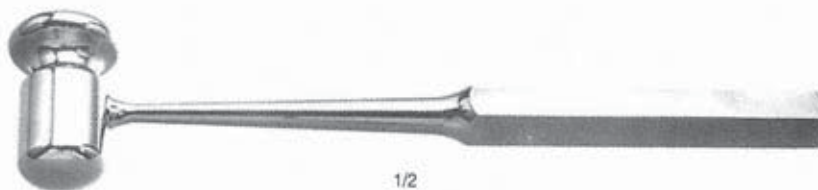

MAC EVEN TETE DOUBLE - 230 mm

MA 258 05	Ø 25 mm	250 gr.
MA 258 06	Ø 30 mm	350 gr.
MA 258 07	Ø 35 mm	500 gr.
MA 258 08	Ø 40 mm	600 gr.
MA 258 09	Ø 45 mm	750 gr.

OMBREDANNE - 230 mm

MA 258 10	Ø 30 mm	500 gr.
MA 258 11	Ø 35 mm	700 gr.
MA 258 12	Ø 40 mm	900 gr.
MA 258 13	Ø 45 mm	1200 gr.

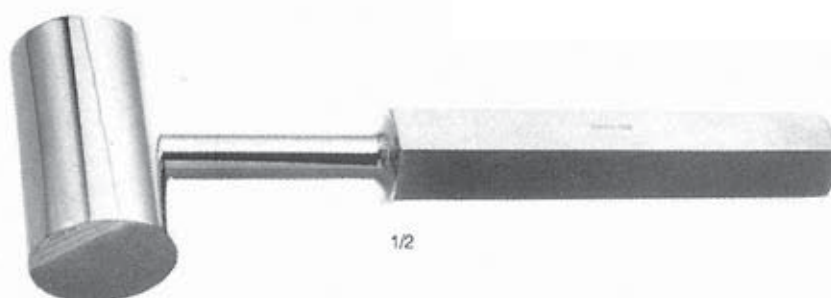

MAIN DE PLOMB

MA 258 14	adulte
MA 258 15	enfant



MANDRIN AVEC CLE

MA 258 16	inox
-----------	------



OUVRE - BOUCHES

DAVIS BOYLE

OU 260 01	COMPLET
COMPRENANT :	
OU 260 02	cadre seul
	Abaisse langue
OU 260 03	21 x 26 mm
OU 260 04	23 x 65 mm
OU 260 05	24 x 80 mm
OU 260 06	25 x 93 mm
OU 260 07	26 x 108 mm

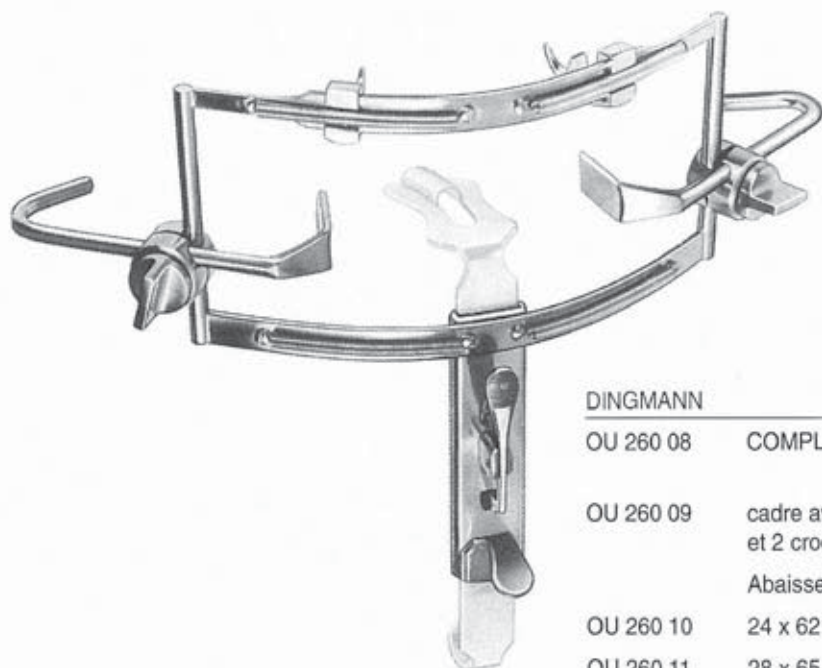

DINGMANN

OU 260 08	COMPLET COMPRENANT :
OU 260 09	cadre avec 2 fixe-joues et 2 crochets à dents
	Abaisse langue
OU 260 10	24 x 62 mm
OU 260 11	28 x 65 mm
OU 260 12	31 x 75 mm

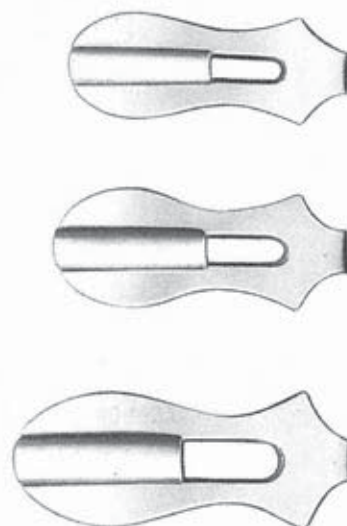



OUVRE - BOUCHES

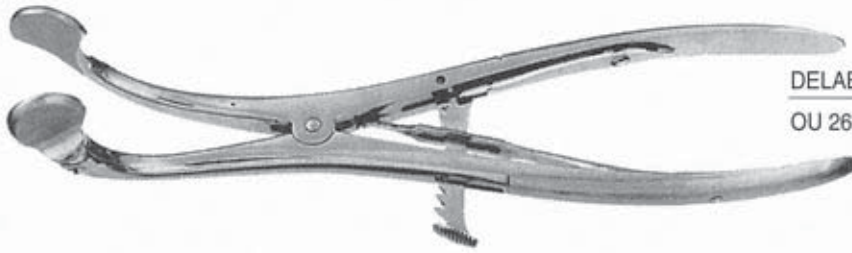

DELABARRE
OU 261 01 200 mm

DOYEN - 120 mm

- | | |
|-----------|--------|
| OU 261 02 | adulte |
| OU 261 03 | enfant |

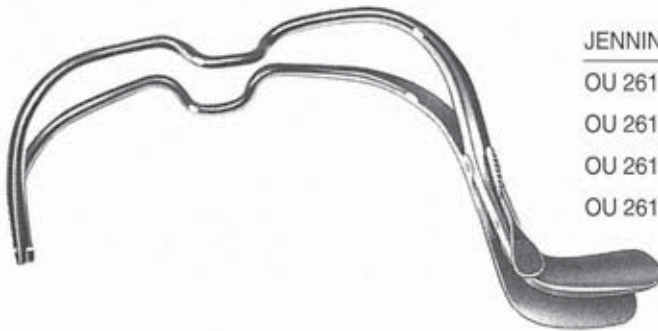

JENNINGS

- | | |
|-----------|--------|
| OU 261 04 | 80 mm |
| OU 261 05 | 110 mm |
| OU 261 06 | 130 mm |
| OU 261 07 | 150 mm |

KILNER - DOUGHTY

- | | |
|-----------|---|
| OU 261 08 | COMPLET COMPRENANT : |
| OU 261 09 | cadre avec 2 crochets à dents
et 1 spatule à palais pour édentés |

Abaisse langue

- | | |
|-----------|------------|
| OU 261 10 | 28 x 65 mm |
| OU 261 11 | 32 x 75 mm |
| OU 261 12 | 37 x 80 mm |

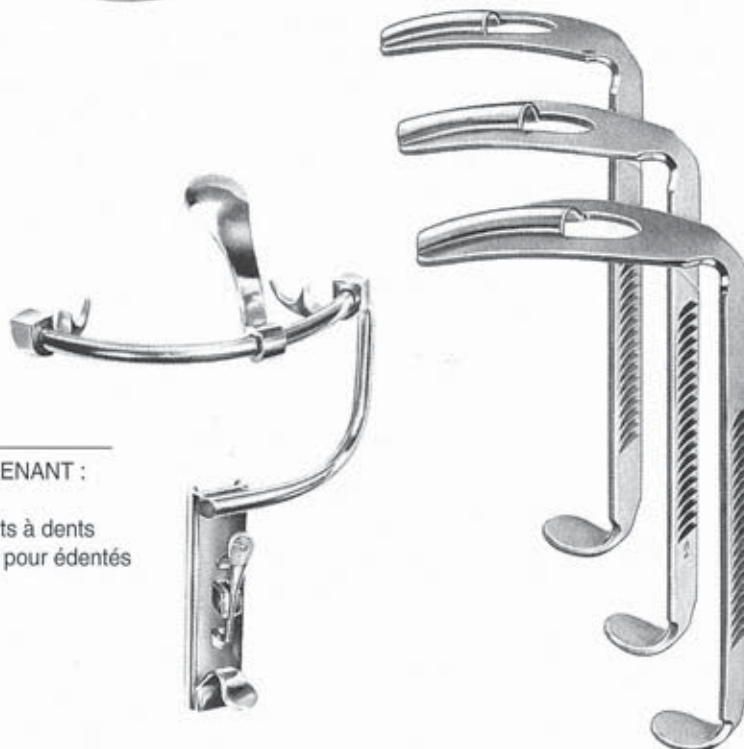



MOLT

OU 262 01	150 mm	adulte
OU 262 02	100 mm	enfant

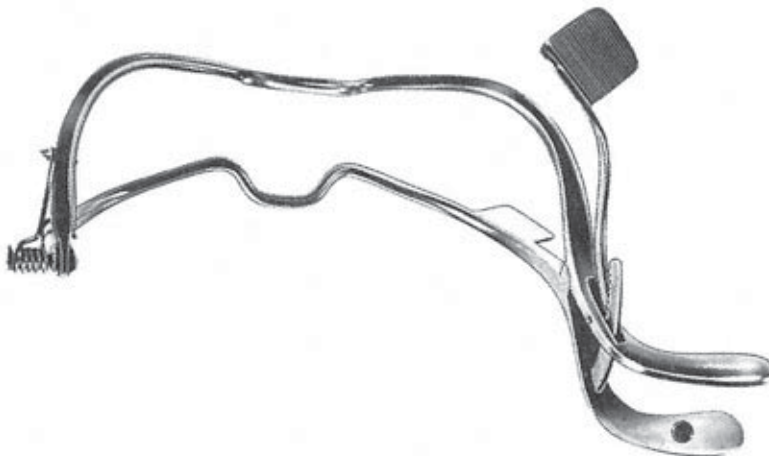

SEEMANN SEIFERT

OU 262 06	110 mm
OU 262 07	130 mm



OUVRE - BOUCHES



TERRIER - 200 mm

OU 263 01 droit

OU 263 02 courbe



P

	PAGES
PASSE FILS	266 - 272
PERFORATEURS	274
PINCES	
BIOPSIE	275 - 279
CALCULS	281 - 282
CHAMPS	284 - 285
COAGULER	287 - 288
COUPANTES	290 - 293
DISSEQUER	295 - 315
DIVERSES	317
ECHARDES - ENVIE - EPILER	319
FILS D'ACIER	321 - 323
GOUGES	325 - 333
GYNECO	335 - 340
HEMOSTATIQUES	342 - 362
MENISQUES	365
ONGLES	366
ORL	367 - 373
PANSEMENTS	376 - 380
PLATRE	382
PREHENSION	383 - 390
PRESSE TUBES	392
PROSTATIQUES	393
POINTES CARREES	395
PORTE AIGUILLES	397 - 408
PORTE COTON	410



PASSE LACS	VOIR TOURNIQUET
PERCE MEMBRANE	VOIR PINCES GYNECO
PINCES A AGRAFES	VOIR AGRAFES
PINCES CLAMPS	VOIR CLAMPS
PINCES COUPE FILS D'ACIER	VOIR PINCES FILS D'ACIER
PINCE A DECAPSULER	VOIR PINCES DIVERSES
PINCES DISQUES	VOIR RONGEURS
PINCES A INTUBATION	VOIR PINCES DIVERSES
PINCES LONGUETTES	VOIR PINCES PANSEMENTS
PINCES A PANSEMENTS D'OREILLE	VOIR PINCES ORL
PINCE TIRE BROCHES	VOIR PINCE FILS D'ACIER
PINCE A TRAIRE	VOIR PINCES DIVERSES
POIGNEE EN "T"	VOIR MANDRIN
PRESSE TUBES	VOIR PINCE PRESSE TUBES



PASSE - FILS



DANIS

PA 266 01	petit modèle	170 mm
PA 266 02	moyen modèle	190 mm
PA 266 03	grand modèle	210 mm

HARRINGTON

PA 266 04 300 mm

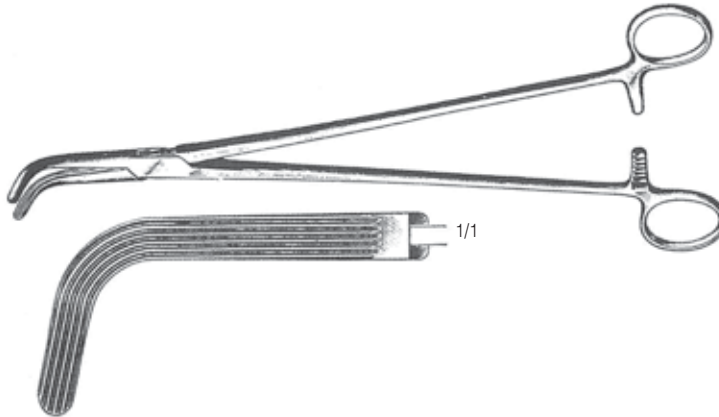

1/1

LAWRENCE

PA 266 05 280 mm

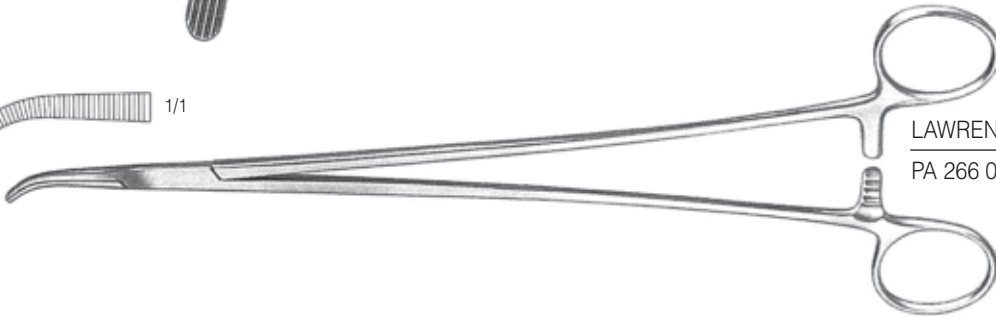

1/1

MEEKER

PA 266 06 280 mm

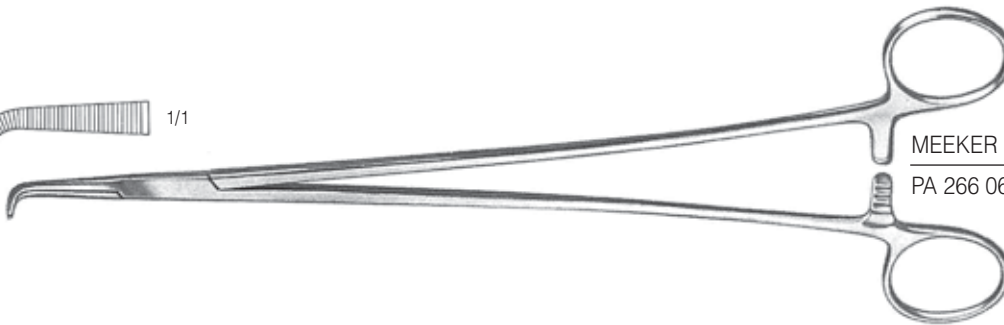

1/1

MIXTER

PA 266 07 280 mm

PA 266 08 250 mm

PA 266 09 230 mm

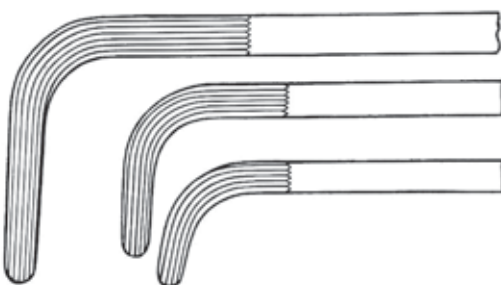

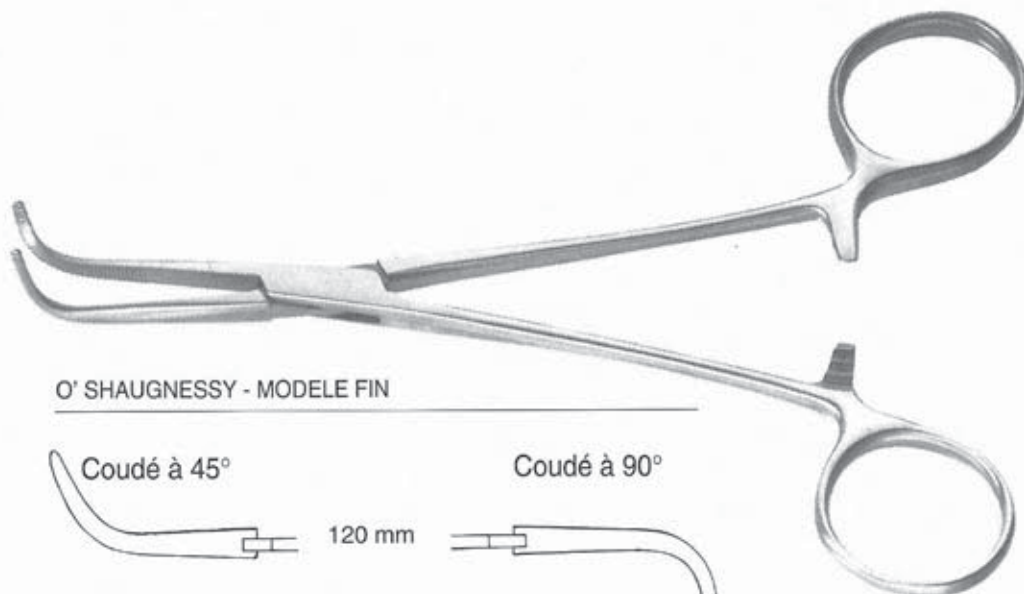

O' SHAUGNESSY - MODELE FIN

Coudé à 45°

Coudé à 90°



120 mm

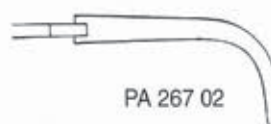

PA 267 01

PA 267 02



140 mm



PA 267 03

PA 267 04

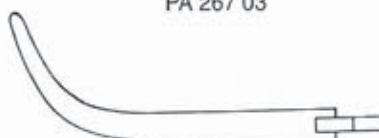

180 mm

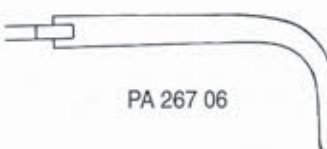

PA 267 05

PA 267 06



200 mm

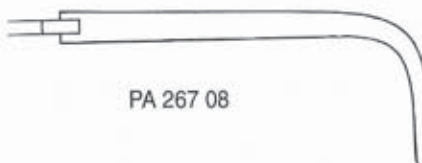

PA 267 07

PA 267 08

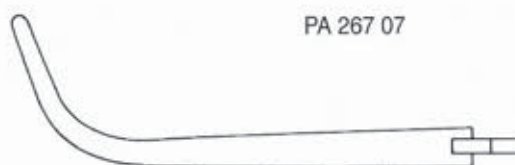

220 mm

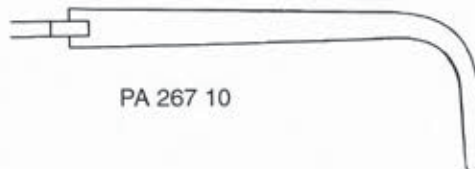

PA 267 09

PA 267 10

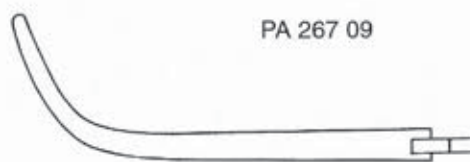

240 mm

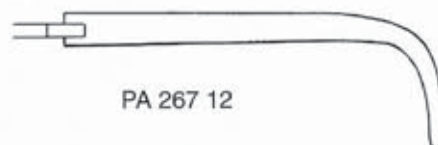

PA 267 11

PA 267 12



300 mm

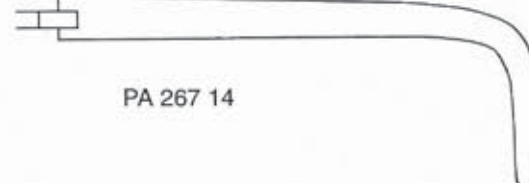

PA 267 13

PA 267 14



PASSE - FILS

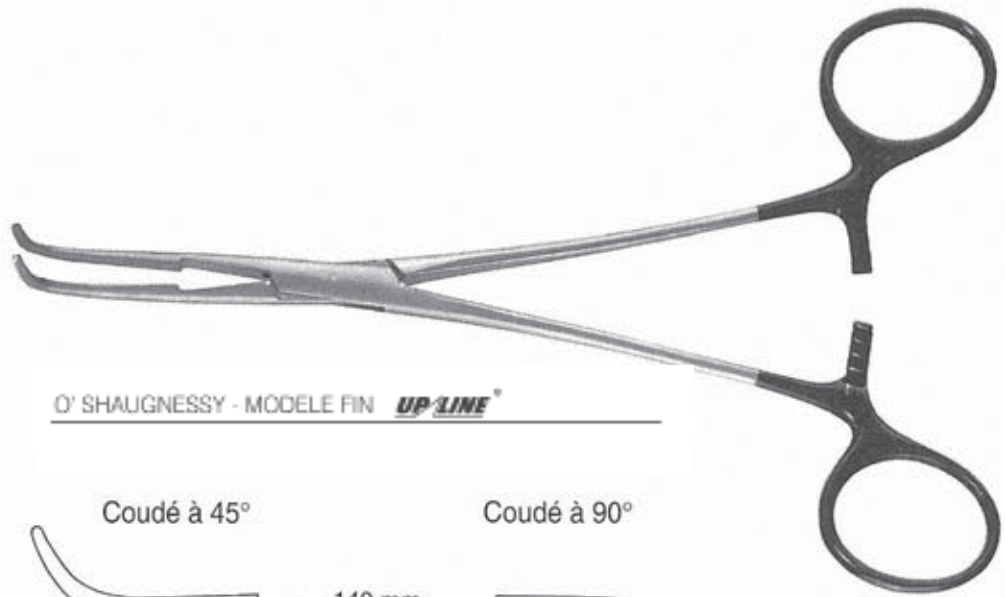

O' SHAUGNESSY - MODELE FIN **UP-LINE**[®]

Coudé à 45°

Coudé à 90°

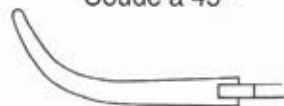

140 mm



PA 268 01

PA 268 02



180 mm

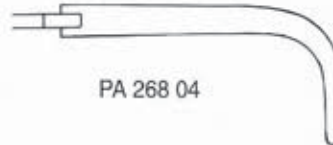

PA 268 03

PA 268 04



200 mm

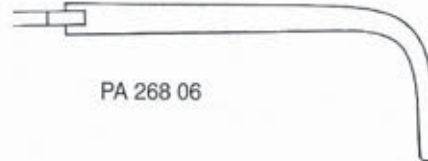

PA 268 05

PA 268 06



240 mm

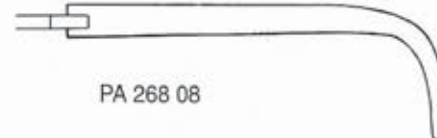

PA 268 07

PA 268 08



300 mm

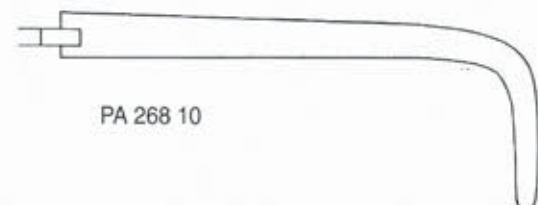

PA 268 09

PA 268 10



PASSE - FILS

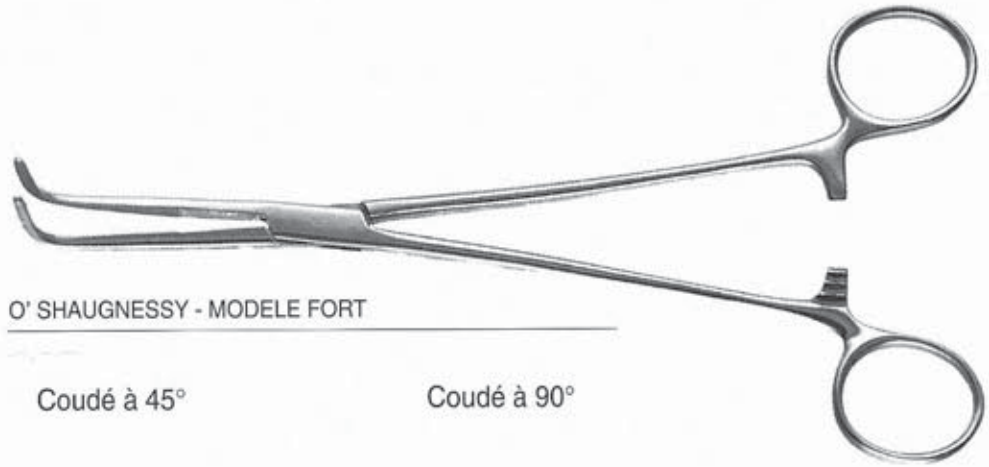

O' SHAUGNESSY - MODELE FORT

Coudé à 45°

Coudé à 90°

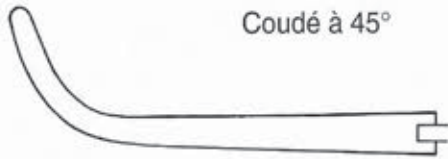

200 mm

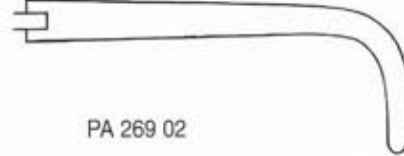

PA 269 01

PA 269 02



220 mm

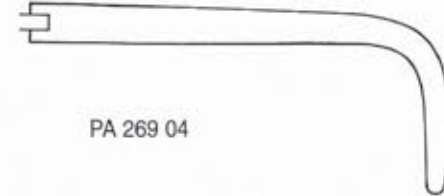

PA 269 03

PA 269 04

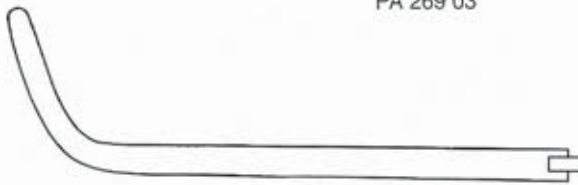

240 mm



PA 269 05

PA 269 06

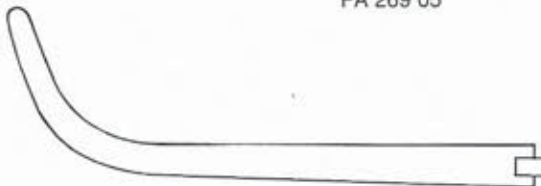

260 mm

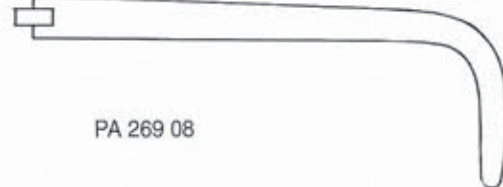

PA 269 07

PA 269 08



300 mm

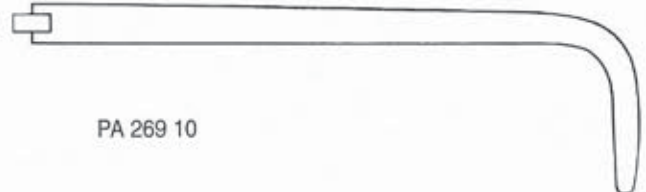

PA 269 09

PA 269 10



PASSE - FILS

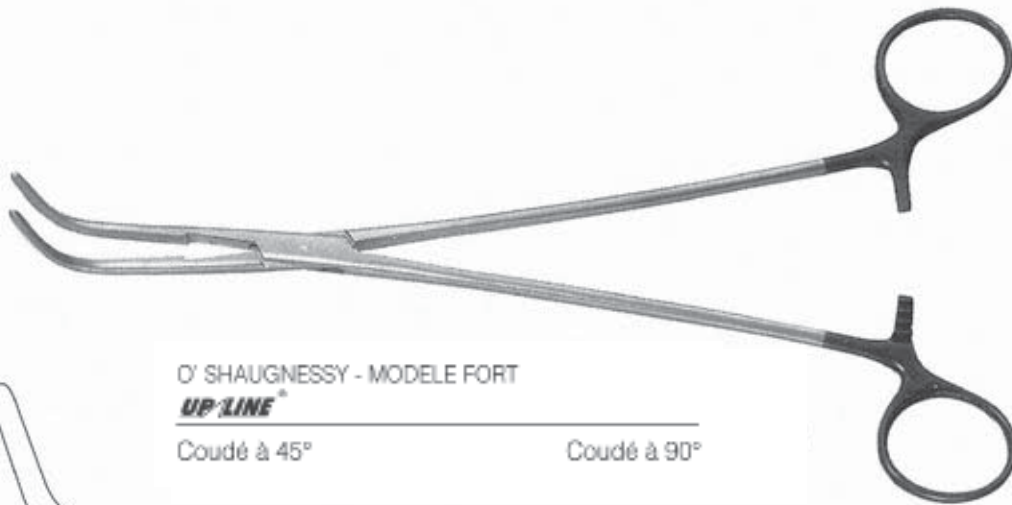

O' SHAUGNESSY - MODELE FORT
UP-LINE

Coudé à 45°

Coudé à 90°

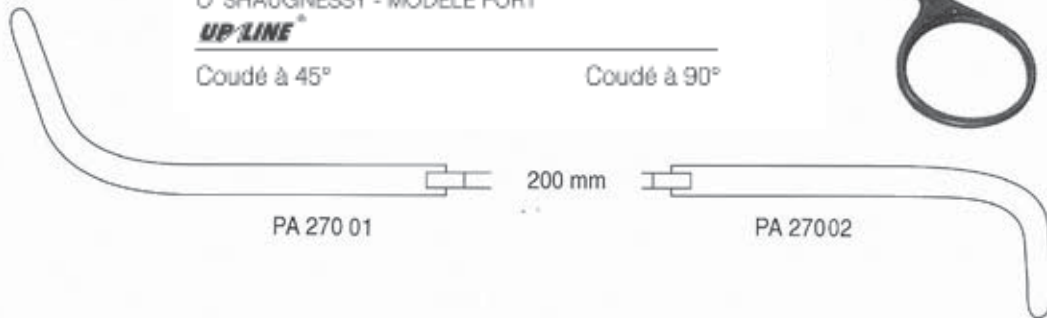

PA 270 01

200 mm

PA 27002

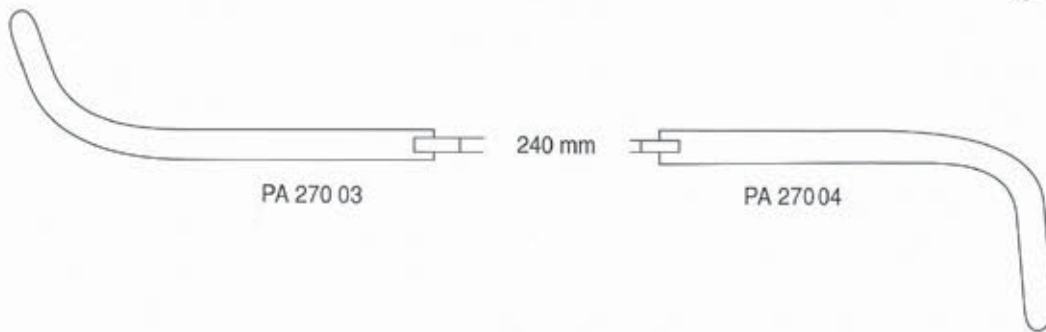

PA 270 03

240 mm

PA 27004

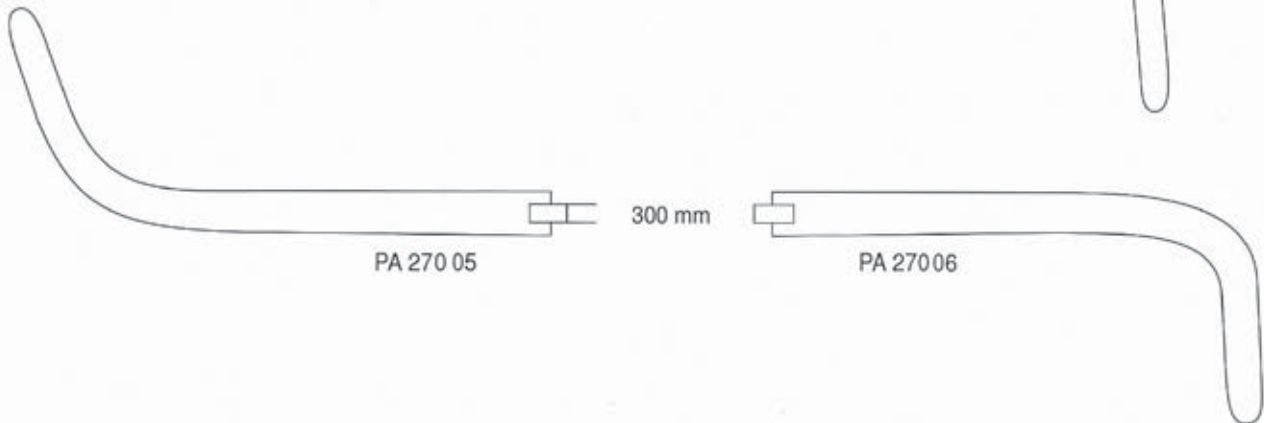

PA 270 05

300 mm

PA 27006

O' SHAUGNESSY **UP-LINE**
Modèle en "S" - 225 mm

PA 270 07

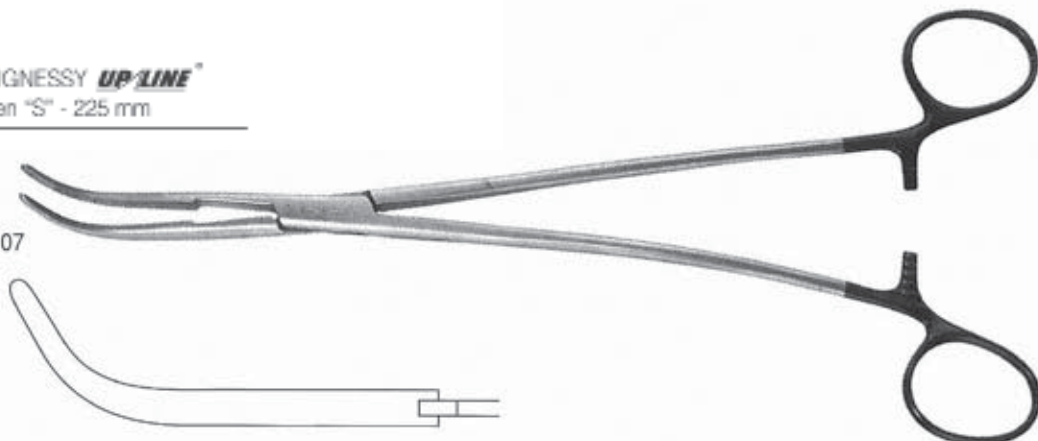



PASSE - FILS

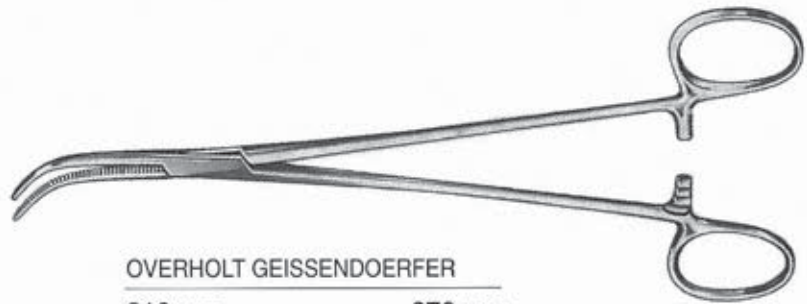

OVERHOLT GEISSENDOERFER

210 mm

270 mm

PA 271 01

PA 271 02

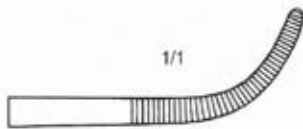

Fig 1



Fig 2



Fig 3

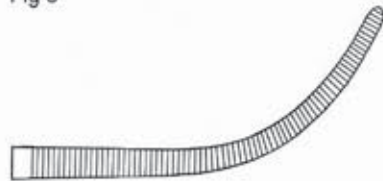

Fig 4

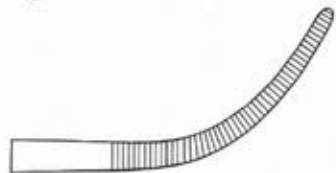

Fig 5

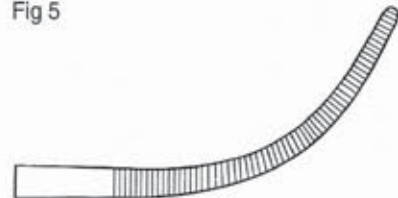

Fig 6



Fig 7

PA 271 03

PA 271 04

PA 271 05

PA 271 06

PA 271 07

PA 271 08

PA 271 09

PA 271 10

PA 271 11

PA 271 12

PA 271 13

PA 271 14



PASSE - FILS

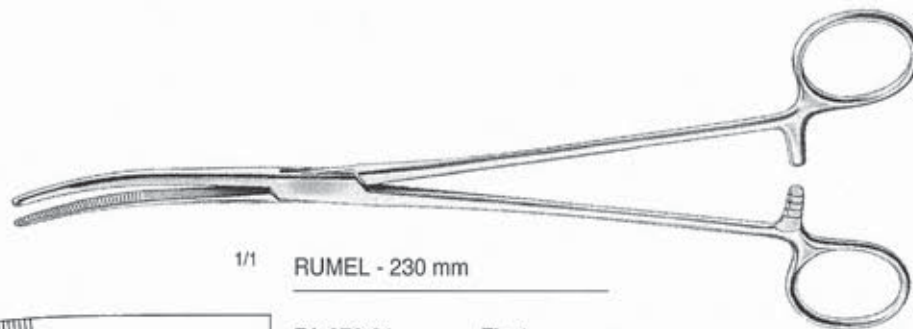

1/1 RUMEL - 230 mm

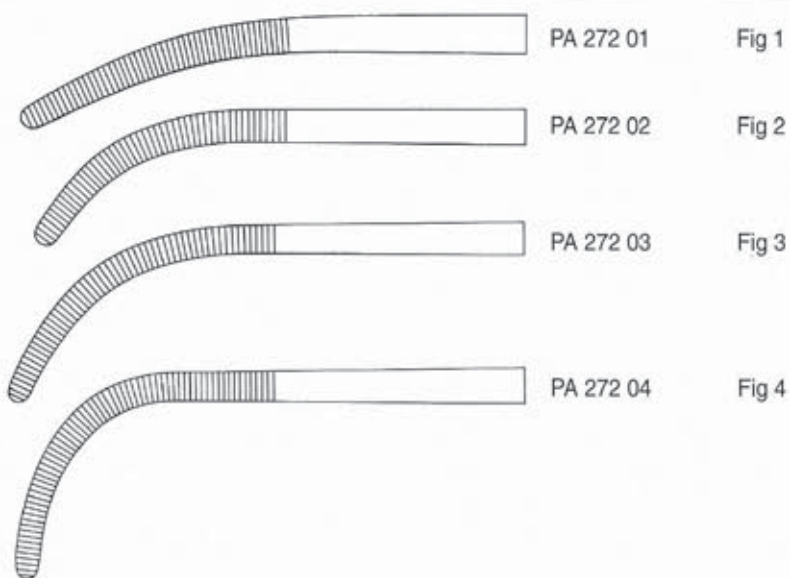

PA 272 01 Fig 1

PA 272 02 Fig 2

PA 272 03 Fig 3

PA 272 04 Fig 4

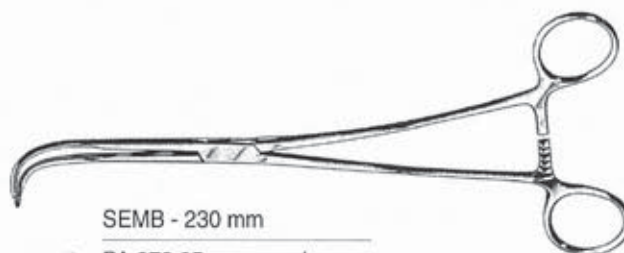

SEMB - 230 mm

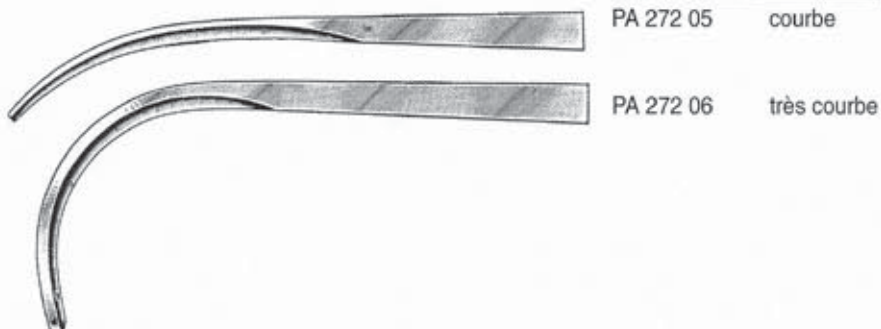

PA 272 05 courbe

PA 272 06 très courbe

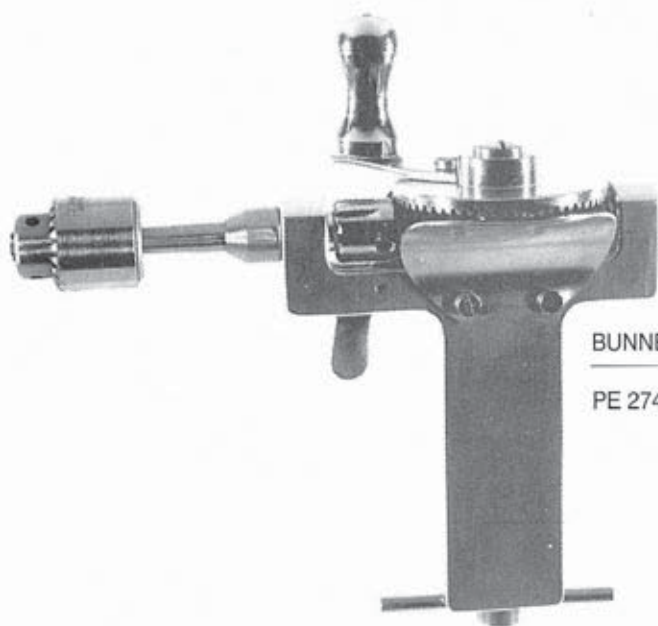

BUNNEL - 160 mm

PE 274 01

Mandrin à trois mâchoires
pour tiges jusqu'à 4 mm de diamètre
Livré avec clé



RALK - 160 mm

PE 274 02

Mandrin à trois mâchoires
pour tiges jusqu'à 6 mm de diamètre
Livré avec clé



UNIVERSEL - 280 mm

PE 274 03

Mandrin à trois mâchoires
pour tiges jusqu'à 6,3 mm de diamètre
poignée orientable
Livré avec clé



PINCES BIOPSIE GYNECOLOGIE



BERGER - 210 mm
PI 275 01



DOUAY

PI 275 02	200 mm
PI 275 03	250 mm
PI 275 04	300 mm
PI 275 05	350 mm
PI 275 06	400 mm

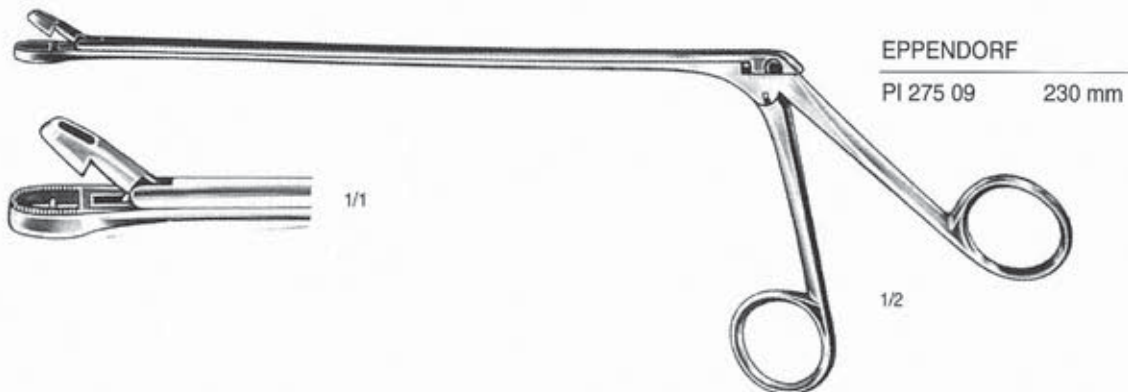

EPPENDORF
PI 275 09 230 mm



GYNECOLOGIE

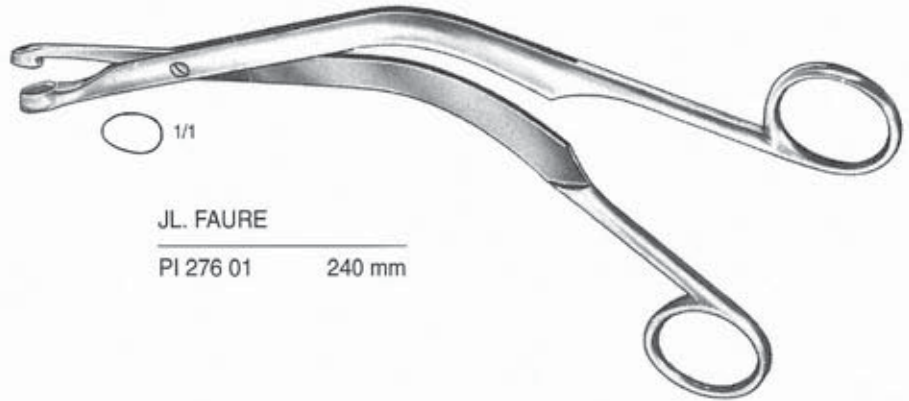

JL. FAURE
PI 276 01 240 mm

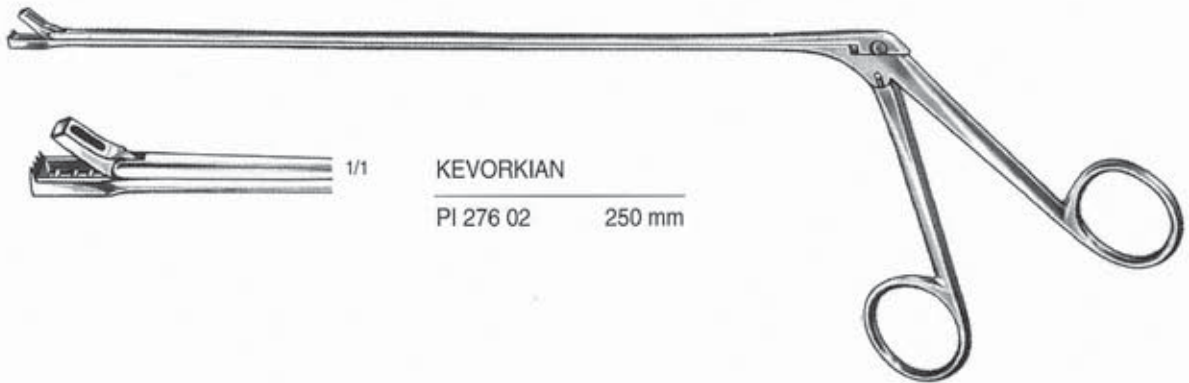

KEVORKIAN
PI 276 02 250 mm

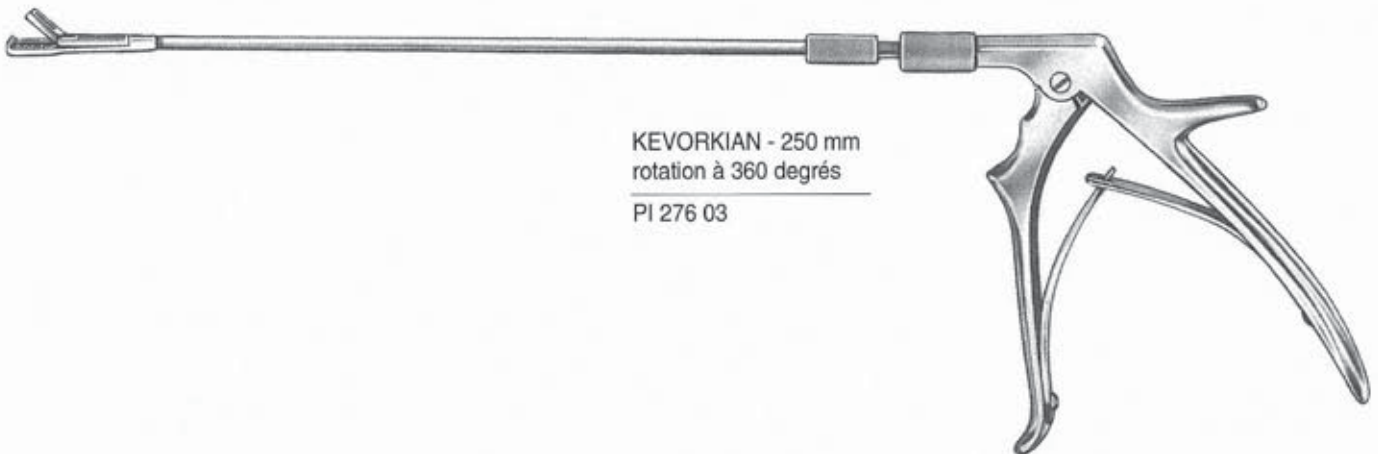

KEVORKIAN - 250 mm
rotation à 360 degrés
PI 276 03



PINCES BIOPSIE

GYNECOLOGIE

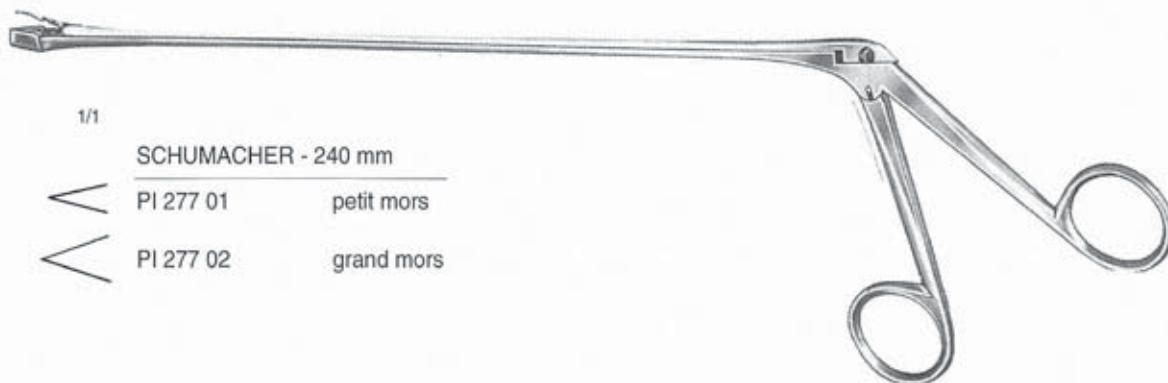

1/1

SCHUMACHER - 240 mm



PI 277 01 petit mors



PI 277 02 grand mors

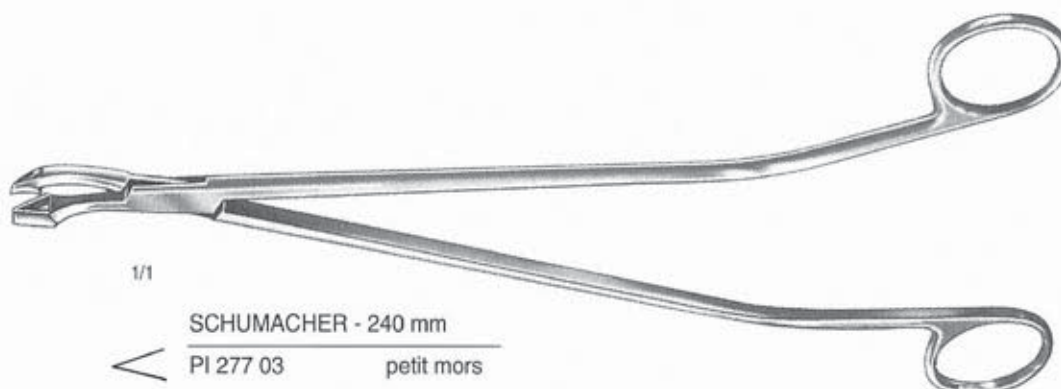

1/1

SCHUMACHER - 240 mm



PI 277 03 petit mors



PI 277 04 grand mors

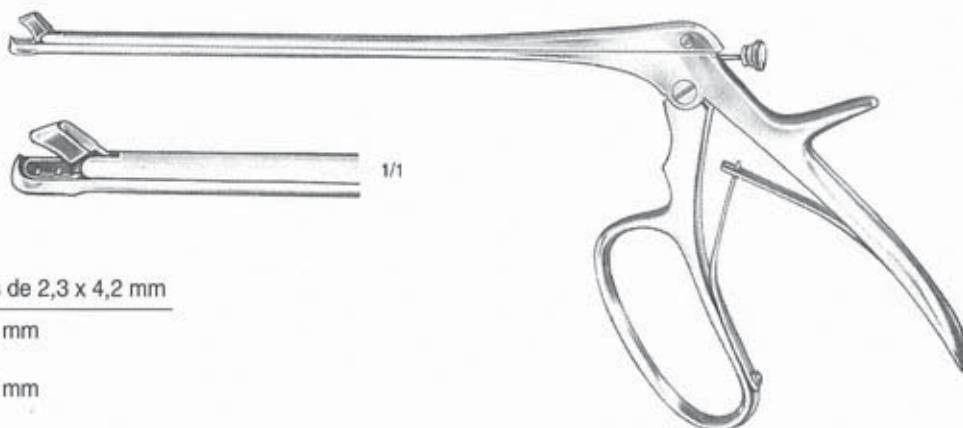

TISCHLER - Mini - Mors de 2,3 x 4,2 mm

PI 277 05 200 mm

PI 277 06 250 mm



GYNECOLOGIE

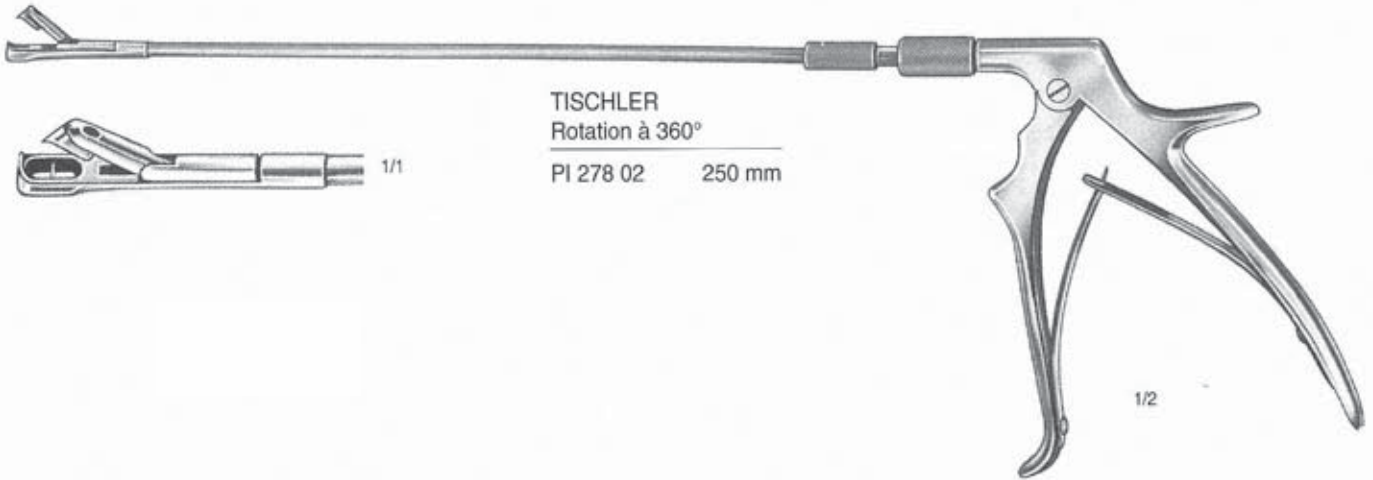



PINCES BIOPSIE

RECTALES

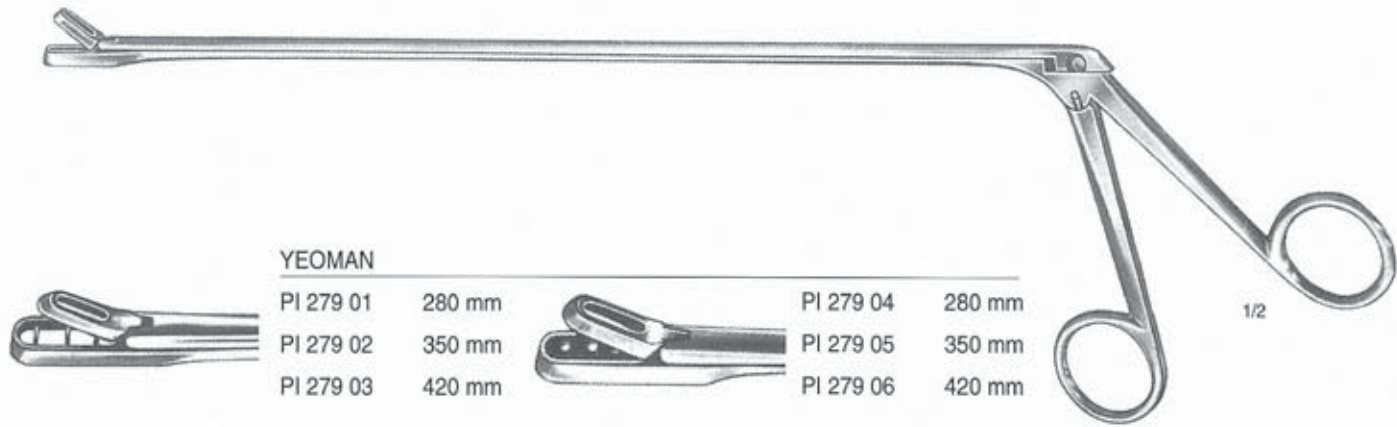

YEOMAN



PI 279 01	280 mm
PI 279 02	350 mm
PI 279 03	420 mm



PI 279 04	280 mm
PI 279 05	350 mm
PI 279 06	420 mm

1/2

YEOMAN A ROTATION - 360 Degrés

Mors de 4 x 11 mm

Mors droit 330 mm 400 mm



1/1

PI 279 07

PI 279 08



PI 279 09

PI 279 10

Mors coudés



PI 279 11

PI 279 12



1/1

PI 279 13

PI 279 14

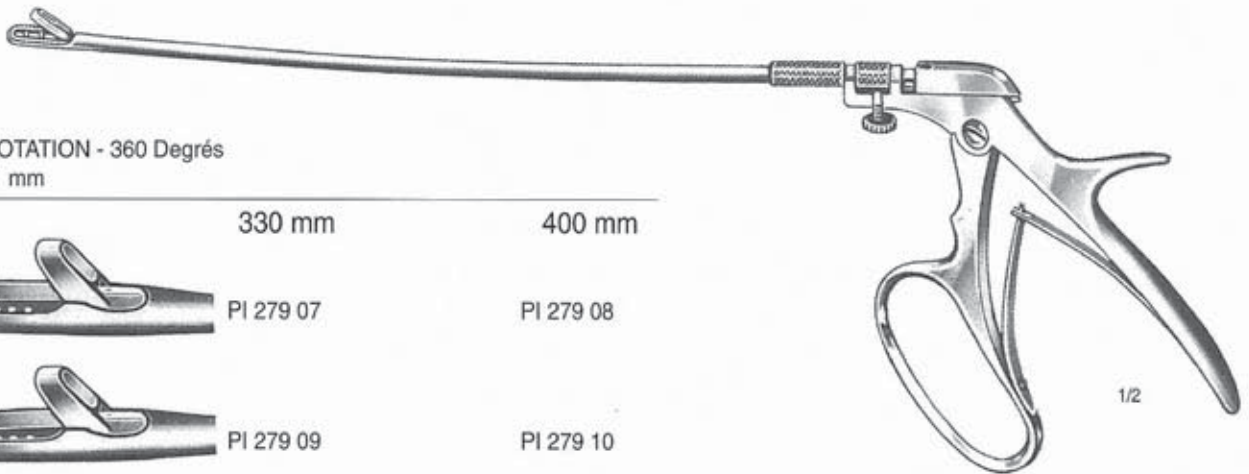

1/2

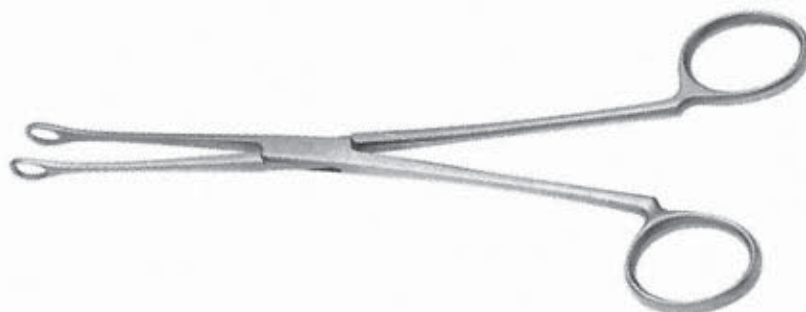

BLACKE - 210 mm

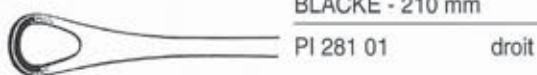

DESJARDINS - 230 mm





PINCES CALCULS

MIRIZZI - 230 mm

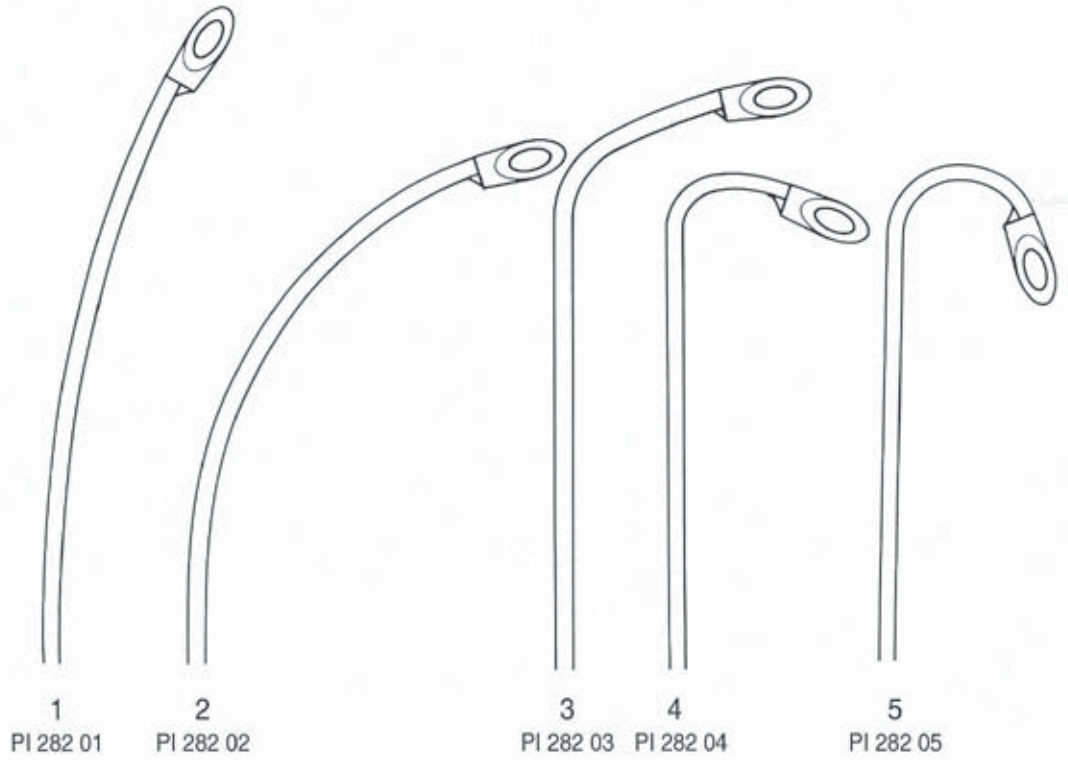

1
PI 282 01

2
PI 282 02

3
PI 282 03

4
PI 282 04

5
PI 282 05

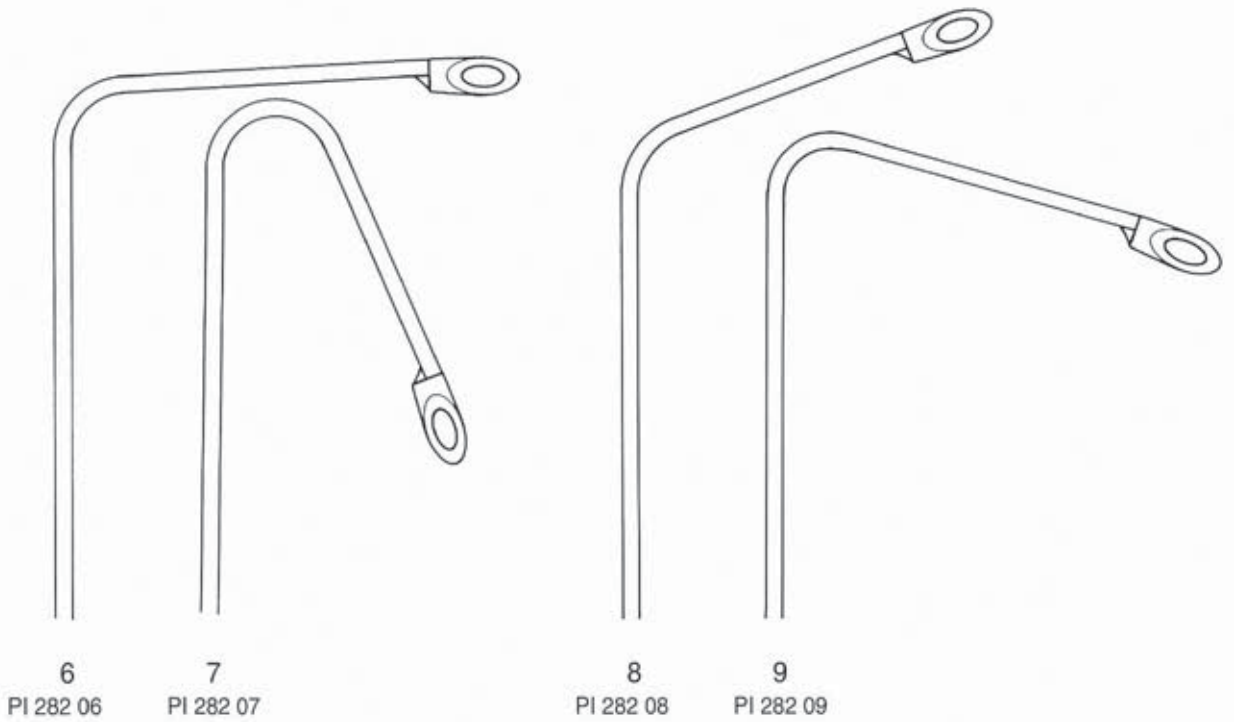

6
PI 282 06

7
PI 282 07

8
PI 282 08

9
PI 282 09



BACKAUS

PI 284 01	90 mm
PI 284 02	120 mm
PI 284 03	140 mm

BACKAUS - PORTE TUBE

PI 284 04	140 mm
-----------	--------

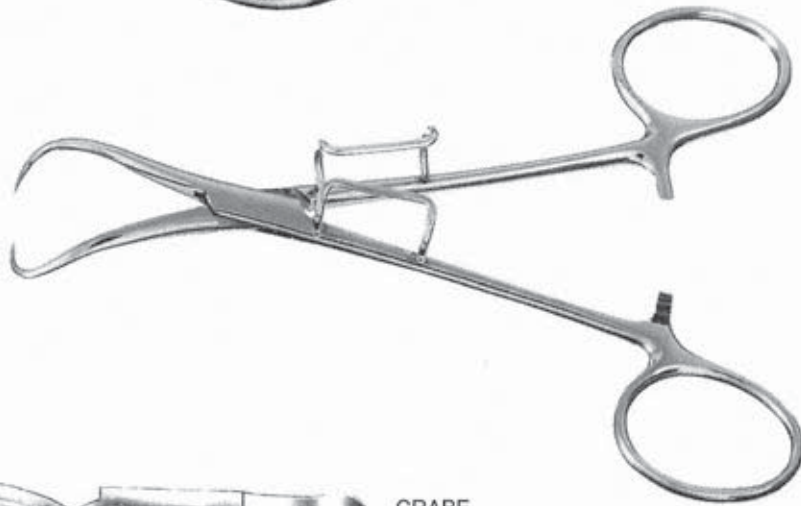

CRABE

PI 284 05	90 mm
-----------	-------



DOYEN

PI 284 06	180 mm
-----------	--------



JAYLE

PI 284 07	130 mm
-----------	--------





PINCES CHAMPS

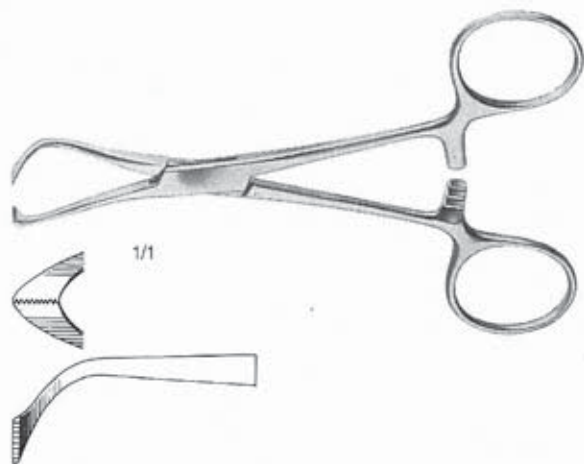

LORNA
(pour Champs papier)
PI 285 01 140 mm

PAUCHET
(Tenaille)
PI 285 02 200 mm

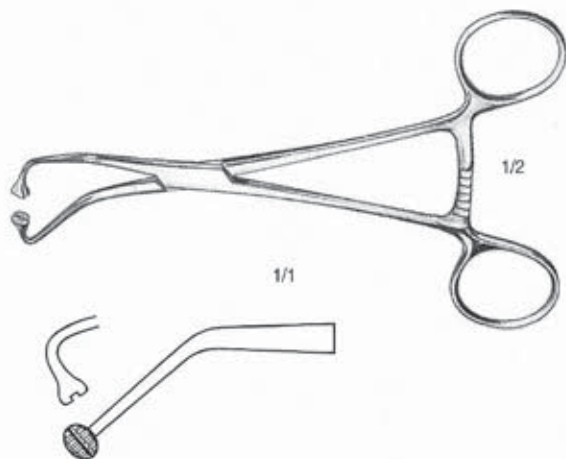

PEERS
(pour Champs papier)
PI 285 03 140 mm

TISSERAND
PI 285 04 140 mm





PINCES A COAGULER BIPOLAIRES

DROITE



Mors	Longueur	Références		
		Mors 0.3 mm pointu	Mors 1 mm mousse	Mors 2 mm mousse
	150 mm	PI 28701	PI 28713	PI 28714
	180 mm	PI 28717	PI 28718	PI 28719
	200 mm	PI 28704	PI 28725	PI 28726
	220 mm	PI 28737	PI 28738	PI 28739
	240 mm	PI 28746	PI 28747	PI 28748
	150 mm	PI 28702	PI 28715	PI 28716
	180 mm	PI 28720	PI 28721	PI 28722
	200 mm	PI 28705	PI 28727	PI 28728
	220 mm	PI 28740	PI 28741	PI 28742
	240 mm	PI 28749	PI 28750	PI 28751

BAÏONNETTE



Mors	Longueur	Références		
		Mors 0.3 mm pointu	Mors 1 mm mousse	Mors 2 mm mousse
	180 mm	PI 28703	PI 28723	PI 28724
	200 mm	PI 28706	PI 28729	PI 28730
	220 mm	PI 28743	PI 28744	PI 28745
	240 mm	PI 28752	PI 28753	PI 28754
Coudé Bas 	200 mm	PI 28731	PI 28732	PI 28733
	240 mm	PI 28755	PI 28756	PI 28757
Coudé Haut 	200 mm	PI 28734	PI 28735	PI 28736
	240 mm	PI 28758	PI 28759	PI 28760

MODELE MICRO 110 mm

Mors		Références	
		Mors 0.25 mm pointu	Mors 0.6 mm mousse
	Droit	PI 28707	PI 28710
	Courbe	PI 28709	PI 28712
	Coudé	PI 28708	PI 28711

CORDON POUR PINCE

Longueur	Erbe	Martin-Berchtold	Valleylab-Lamidey	AEsculap-GK50	Codman-CMC II
3 m	PI 28763	PI 28764	PI 28765	PI 28761	PI 28762
5 m	PI 28768				



PINCES COAGULER

MONOPOLAIRES



CUSHING - 180 mm

- | | |
|-----------|--------------|
| PI 288 01 | à griffes |
| PI 288 02 | sans griffes |



CLOVIS VINCENT - 200 mm

- | | |
|-----------|--------------|
| PI 288 03 | à griffes |
| PI 288 04 | sans griffes |





DEMARTEL - 250 mm

- | | |
|-----------|--------------|
| PI 288 05 | à griffes |
| PI 288 06 | sans griffes |





"POUR COUPE-FILS ET BROCHES
VOIR PAGE 321"

DOUBLE ARTICULATION

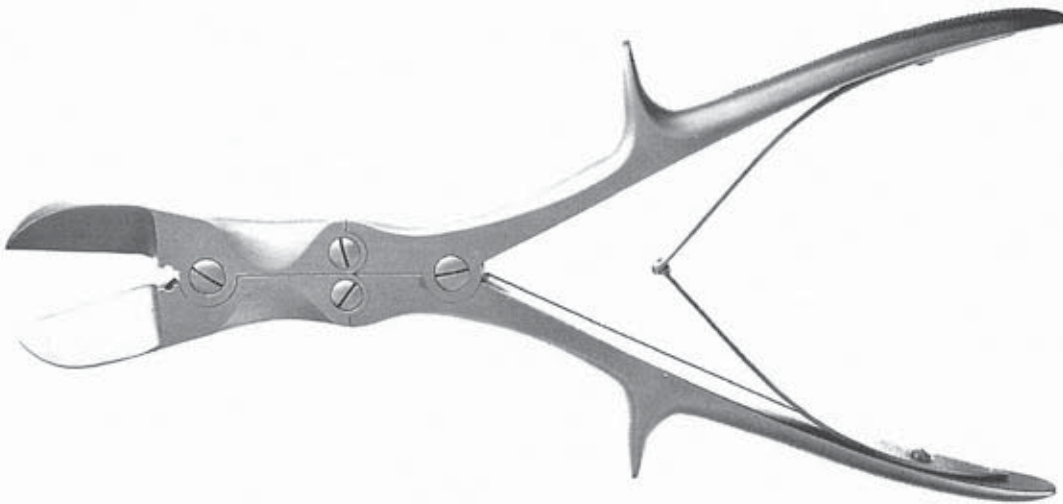
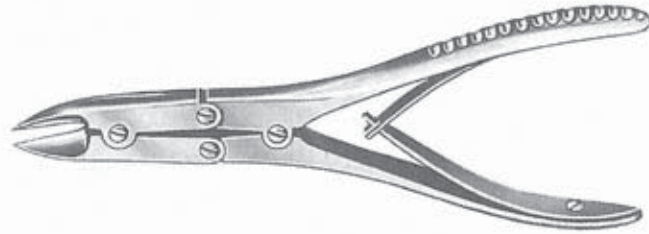
1/1	LISTON - 150 mm	
	PI 290 01	droite
	PI 290 02	coudée



LISTON

1/1	droite		1/1	coudée	
	PI 290 03	230 mm		PI 290 05	230 mm
	PI 290 04	270 mm		PI 290 06	270 mm

LISTON - KEY - HORSLEY

PI 290 07 260 mm

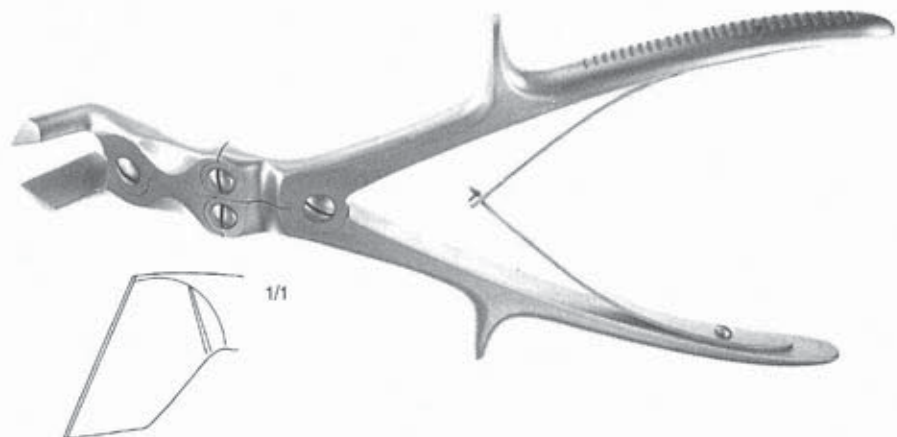



PINCES COUPANTES

DOUBLE ARTICULATION

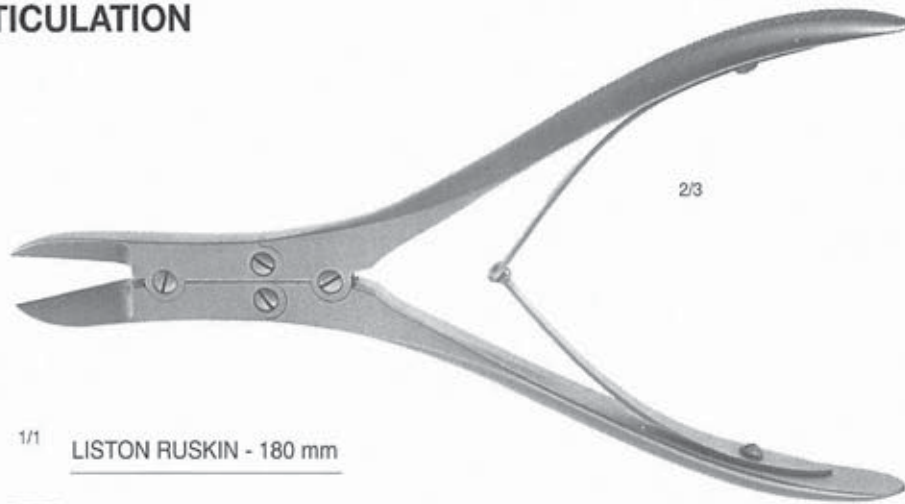

^{1/1} LISTON RUSKIN - 180 mm

-  PI 291 01 droite
-  PI 291 02 coudée

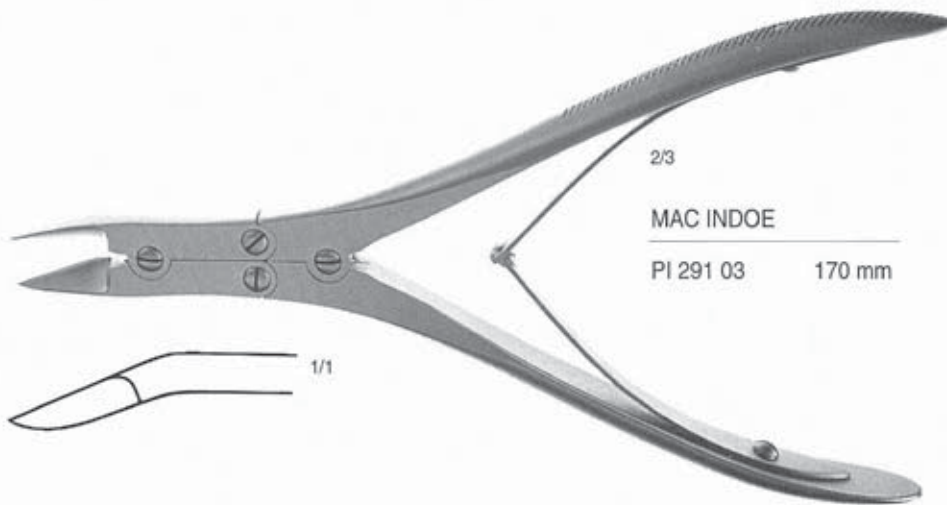

^{2/3}
MAC INDOE
PI 291 03 170 mm



TUDOR EDWARDS
PI 291 04 230 mm

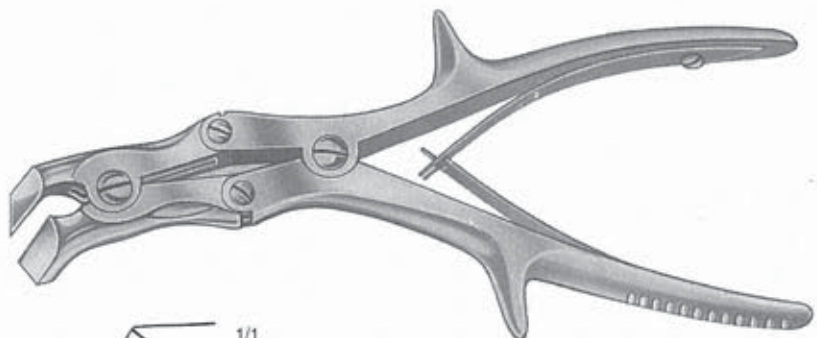



"POUR COUPE-FILS ET BROCHES
VOIR PAGE 321"

PINCES COUPANTES

SIMPLE ARTICULATION

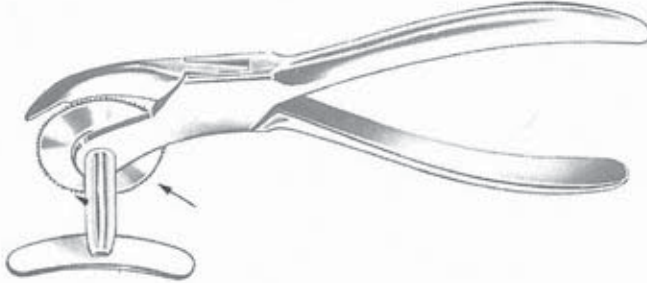

COUPE BAGUES

- PI 292 01 170 mm
- PI 292 02 lame de scie de rechange
- PI 292 02D lame de scie de rechange DIAMANTEE

COUPE CLAMP DE BAR Plastique

PI 292 03 140 mm

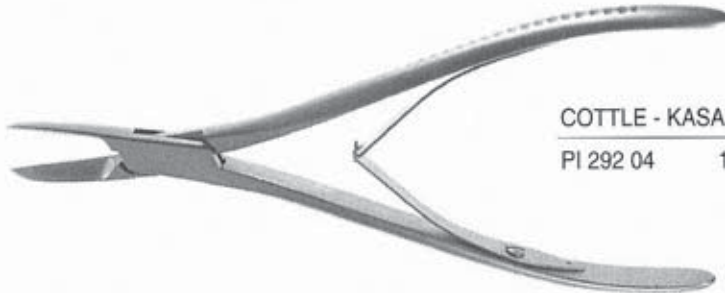

COTTLE - KASADJIAN

PI 292 04 180 mm

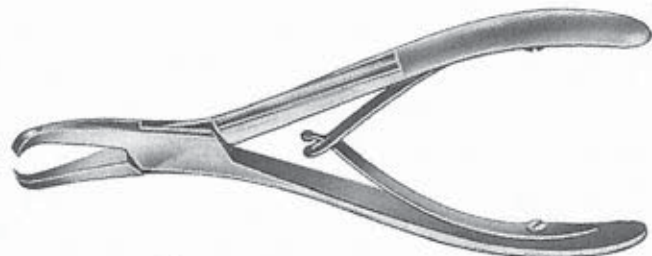

GARDNER - 160 mm

PI 292 05 4 mm



PI 292 06 6 mm





PINCES COUPANTES

SIMPLE ARTICULATION



LISTON

	droite	coudée
150 mm	PI 293 01	PI 293 02
170 mm	PI 293 03	PI 293 04
190 mm	PI 293 05	PI 293 06
220 mm	PI 293 07	PI 293 08

LISTON LITTAUER - 150 mm

PI 293 09 droite



VELPEAU - 240 mm

PI 293 10 (tricoise)



PINCES DISSEQUER

ADLERKREUTZ

	étroite	large
150 mm	PI 295 01	PI 295 02
200 mm	PI 295 03	PI 295 04
250 mm	PI 295 05	PI 295 06
300 mm	PI 295 07	PI 295 08

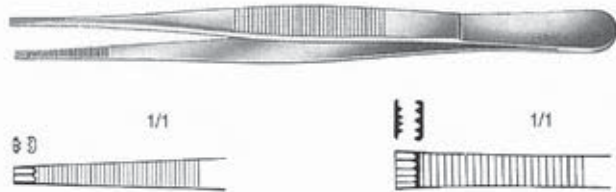

ADSON - 120 mm

PI 295 09	1 x 2 griffes
PI 295 10	sans griffes

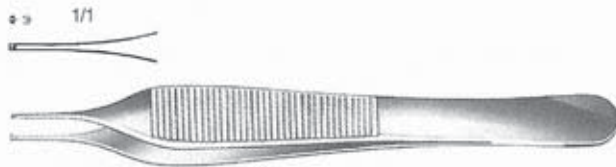

ADSON MICRO

120 mm	150 mm	
PI 295 11	PI 295 12	1 x 2 griffes
PI 295 13	PI 295 14	sans griffes

ADSON TUNGTENE

sans griffes	
PI 295 15	120 mm
PI 295 16	150 mm



avec griffes	
PI 295 17	120 mm

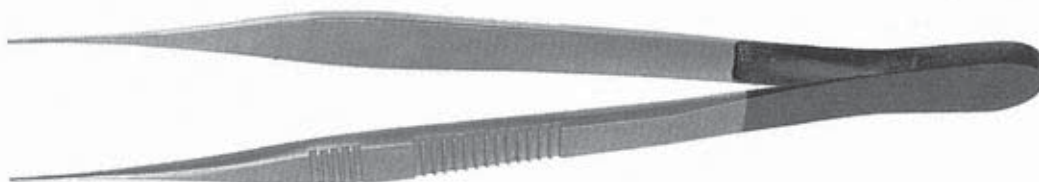

ADSON **UP-LINE**

1/1	sans griffes	1 x 2 griffes
	PI 295 18	PI 295 20
	PI 295 19	PI 295 21
		125 mm
		150 mm



PINCES DISSEQUER

ADSON BROWN - 120 mm
PI 296 01



ADSON GRAEFE - 120 mm
PI 296 02



BARRAYA VISCERALE MORS ETROITS

- PI 292 08 160 mm
- PI 292 04 180 mm
- PI 292 05 200 mm
- PI 292 06 250 mm
- PI 292 07 300 mm

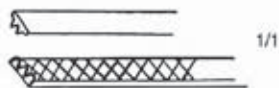



PINCES DISSEQUER

BONNEY - 180 mm
PI 297 01

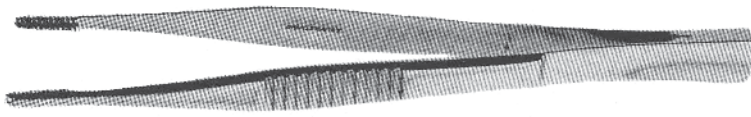
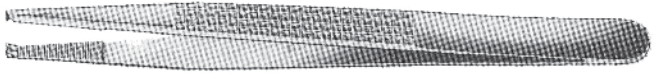

BROWN RESANO

- PI 297 12 160 mm
- PI 297 02 200 mm
- PI 297 03 250 mm
- PI 297 04 300 mm



CHARNLEY (LE PETIT)
PI 297 05 150 mm

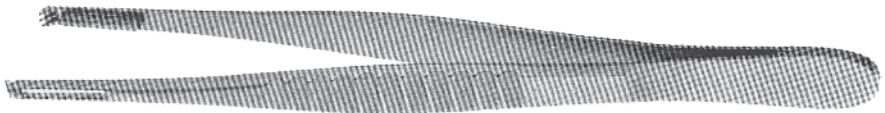

CLOVIS VINCENT

- | | | |
|---------------|--------|--------------|
| 1 x 2 griffes | | sans griffes |
| PI 297 06 | 200 mm | PI 297 07 |
| PI 297 08 | 250 mm | PI 297 09 |
| PI 297 10 | 300 mm | PI 297 11 |



PINCES DISSEQUER



1/1 CLOVIS VINCENT **UP-LINE**

sans griffes



PI 298 01

PI 298 02

1/1

1 x 2 griffes



PI 298 03

200 mm

PI 298 04

250 mm

CUSHING - 180 mm

PI 298 05 1 x 2 griffes

←→

1/1



CUSHING - 180 mm

PI 298 06 sans griffes



1/1

CUSHING TUNGSTENE - 180 mm

PI 298 07



1/1

PINCES DE DEBAKEY ATRAUMATIQUES



1/1

mors de 1,5 mm

PI 299 12	140 mm		PI 299 01	160 mm
PI 299 13	180 mm		PI 299 02	200 mm
PI 299 14	220 mm		PI 299 03	240 mm



mors de 2 mm

PI 299 15	140 mm		PI 299 04	160 mm
PI 299 16	180 mm		PI 299 05	200 mm
PI 299 17	220 mm		PI 299 06	240 mm
			PI 299 07	300 mm
PI 299 18	140 mm		PI 299 08	160 mm
PI 299 19	180 mm		PI 299 09	200 mm
PI 299 20	220 mm		PI 299 10	240 mm
			PI 299 11	300 mm

PINCES DISSEQUER

PINCES DE DEBAKEY ATRAUMATIQUES

1/1



mors de 2,7 mm

PI 300 09 **140 mm**  PI 300 01 **160 mm**

PI 300 10 **180 mm**  PI 300 02 **200 mm**

PI 300 11 **220 mm**  PI 300 03 **240 mm**

 PI 300 04 **300 mm**

1/1



mors de 3,5 mm

 PI 300 05 **160 mm**

PI 300 12 **180 mm**  PI 300 06 **200 mm**

PI 300 13 **220 mm**  PI 300 07 **240 mm**

 PI 300 08 **300 mm**



PINCES DISSEQUER



DEMARTEL

1 x 2 griffes	sans griffes	
PI 301 01	PI 301 02	150 mm
PI 301 03	PI 301 04	200 mm
PI 301 05	PI 301 06	240 mm
PI 301 07	PI 301 08	300 mm

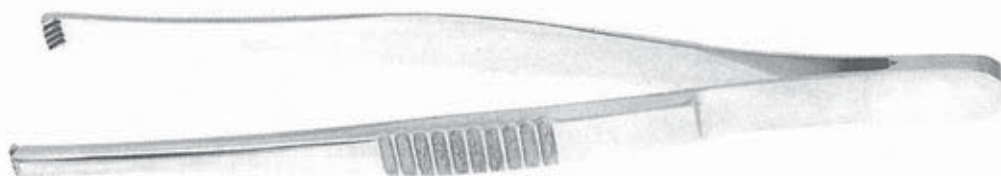

DESGOUTTES

9 griffes

PI 301 09	170 mm
PI 301 10	200 mm
PI 301 11	220 mm
PI 301 12	250 mm
PI 301 13	300 mm

DURAND-PATTE DE VELOURS

PI 301 14	150 mm
PI 301 15	200 mm
PI 301 16	250 mm
PI 301 17	300 mm





PINCES DISSEQUER



DURAND-PATTE DE VELOURS
UP-LINE®

PI 302 01	150 mm
PI 302 02	200 mm
PI 302 03	250 mm



DUVAL



1/1

7 mm

PI 302 04



1/1

10 mm

PI 302 05



1/1

14 mm

PI 302 08



1/1

18 mm

PI 302 09



1/1

27 mm

PI 302 10

Mors
150 mm
200 mm

EVANS TUNGSTENE - 250 mm

PI 302 11



1/1



PINCES DISSEQUER

FARKAS

PI 303 01 150 mm

PI 303 02 180 mm

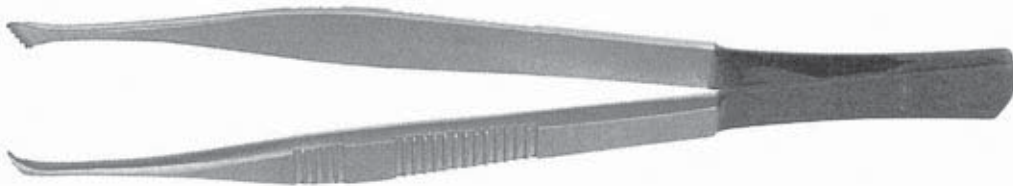

FARKAS

UP-LINE 150 mm

PI 303 03



GERALD - 180 mm

PI 303 04 à griffes

PI 303 05 sans griffes



1/1



1/1

GILLIES - 150 mm

PI 303 06



1/1



PINCES DISSEQUER



1/1 GILLIES - 150 mm

UP-LINE®



PI 304 01 à griffes



PI 304 02 sans griffes

GRAEFE - 110 mm

PI 304 03



GREGOIRE

PI 304 04 180 mm

PI 304 05 200 mm

PI 304 06 250 mm

1/1



GRUENWALD

PI 304 07 200 mm



PINCES DISSEQUER

J.L. FAURE 3 x 4 griffes

PI 305 01 200 mm

PI 305 02 250 mm

PI 305 03 300 mm



1/1



1/1



MAC. INDOE

PI 305 04 150 mm

MOREL FATIO - 150 mm

PI 305 05



1/1

OPHTALMO - 110 mm

PI 305 06 droite 1 x 2 griffes

PI 305 07 droite sans griffes

PI 305 08 courbe 1 x 2 griffes

PI 305 09 courbe sans griffes



PINCES DISSEQUER

OPHTALMO
100 mm - droite

PI 306 01 1 x 2 griffes



1/1

PI 306 02 sans griffes



OPHTALMO
100 mm - faible courbure

PI 306 03 1 x 2 griffes



PI 306 04 sans griffes

OPHTALMO
100 mm - forte courbure

PI 306 05 1 x 2 griffes



1/1

PI 306 06 sans griffes



PERRY - 130 mm

PI 306 07



PINCES DISSEQUER

↔ 1/1



POTTS SMITH

	à griffes	sans griffes
180 mm	PI 307 01	PI 307 02
200 mm	PI 307 03	PI 307 04
250 mm	PI 307 05	PI 307 06

POTTS SMITH - TUNGSTENE

PI 307 07	200 mm
PI 307 08	230 mm
PI 307 09	250 mm

↔ 1/1



PRECELLE - 160 mm



PI 307 10 droite



PI 307 11 coudée



PI 307 12 contre coudée



PINCES DISSEQUER

QUENU - NELSON

PI 308 01	150 mm
PI 308 02	180 mm
PI 308 03	200 mm
PI 308 04	250 mm
PI 308 05	300 mm



QUENU - NELSON *UP-LINE*

1/1



PI 308 06	160 mm
PI 308 07	200 mm
PI 308 08	250 mm

SEMKIN - 125 mm

PI 308 09	1 x 2 griffes
PI 308 10	2 x 3 griffes
PI 308 11	sans griffes



SEMKIN - 130 mm

UP-LINE

PI 308 12	1 x 2 griffes
PI 308 13	sans griffes





PINCES DISSEQUER

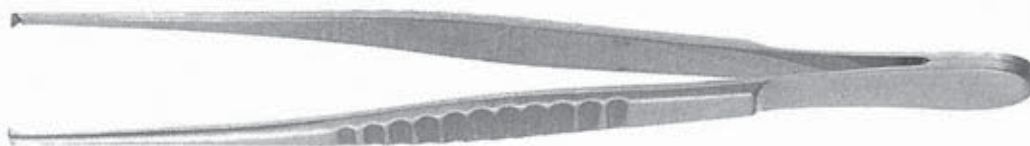

STANDARD DELICATE



	1 x 2 griffes	sans griffes
115 mm	PI 309 01	PI 309 02
130 mm	PI 309 03	PI 309 04
145 mm	PI 309 05	PI 309 06
160 mm	PI 309 07	PI 309 08
180 mm	PI 309 09	PI 309 10
200 mm	PI 309 11	PI 309 12
250 mm	PI 309 13	PI 309 14
300 mm	PI 309 15	PI 309 16



MORS TUNGSTENE DELICATE

PI 309 17	150 mm
PI 309 18	200 mm



STANDARD NORMALE



	1 x 2 griffes	2 x 3 griffes		sans griffes
115 mm	PI 309 19		115 mm	PI 309 20
130 mm	PI 309 21	PI 309 22	130 mm	PI 309 23
145 mm	PI 309 24	PI 309 25	145 mm	PI 309 26
160 mm	PI 309 27	PI 309 28	160 mm	PI 309 29
180 mm	PI 309 30	PI 309 31	180 mm	PI 309 32
200 mm	PI 309 33	PI 309 34	200 mm	PI 309 35
250 mm	PI 309 36	PI 309 37	250 mm	PI 309 38
300 mm	PI 309 39		300 mm	PI 309 40



PINCES DISSEQUER



STANDARD NORMALE
MORS **TUNGSTENE**

PI 310 01	150 mm
PI 310 02	200 mm
PI 310 03	230 mm
PI 310 10	300 mm



1/1

STRASBOURG

	PI 310 04	150 mm
	PI 310 11	180 mm
	PI 310 05	200 mm
	PI 310 06	230 mm

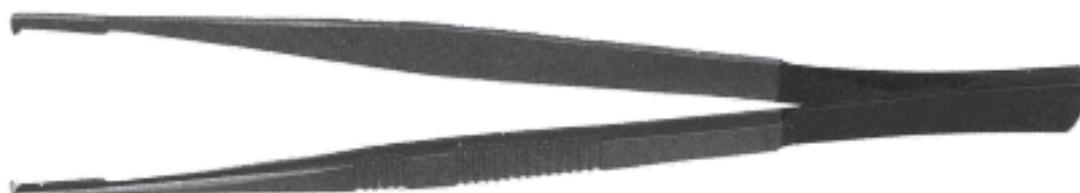

1/1

STRASBOURG **UP-LINE**

	PI 310 07	160 mm
	PI 310 08	200 mm



1/1

TICKNER **TUNGSTENE**

PI 310 09	200 mm
-----------	--------



PINCES DISSEQUER

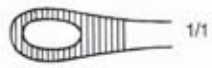

TUTTLE

PI 311 01 180 mm

PI 311 02 230 mm



WANGENSTEEN - TUNGSTENE

PI 311 05 150 mm

PI 311 06 230 mm



PINCES DISSEQUER MICRO



CORPS ROND - 150 mm - à plateaux

- PI 313 01 droite sans griffes
- PI 313 02 droite 1 x 2 griffes
- PI 313 03 courbe sans griffes



CORPS ROND - 180 mm - à plateaux

- PI 313 04 droite sans griffes
- PI 313 05 droite 1 x 2 griffes
- PI 313 06 courbe sans griffes



CORPS ROND 1 x 2 griffes - à plateaux

- PI 313 07 125 mm
- PI 313 08 150 mm
- PI 313 09 180 mm



CORPS ROND sans griffes - à plateaux

- PI 313 10 125 mm
- PI 313 11 150 mm
- PI 313 12 180 mm



PINCES DISSEQUER MICRO



CORPS ROND "COLIBRI" à plateaux

- PI 314 01 125 mm
- PI 314 02 150 mm

DUMONT - 110 mm

N° 2 PI 314 05
Largeur 0,40 mm



N° 3 PI 314 06
Largeur 0,08 mm



N° 4 PI 314 07
Largeur 0,06 mm



N° 2 PI 314 08
Largeur 0,05 mm





PINCES DISSEQUER MICRO



YASARGIL
(Modèle ultra léger)

	Mors droit mousse	Mors droit pointu
180 mm	PI 315 01	PI 315 03
240 mm	PI 315 04	PI 315 06



PINCE A TUMEUR - 200 mm - Ø 4 mm

PI 315 13
Voir référence UL 042
(Catalogue UP-LIGHT)



PINCES DIVERSES

DECAPSULER

PI 317 01 150 mm

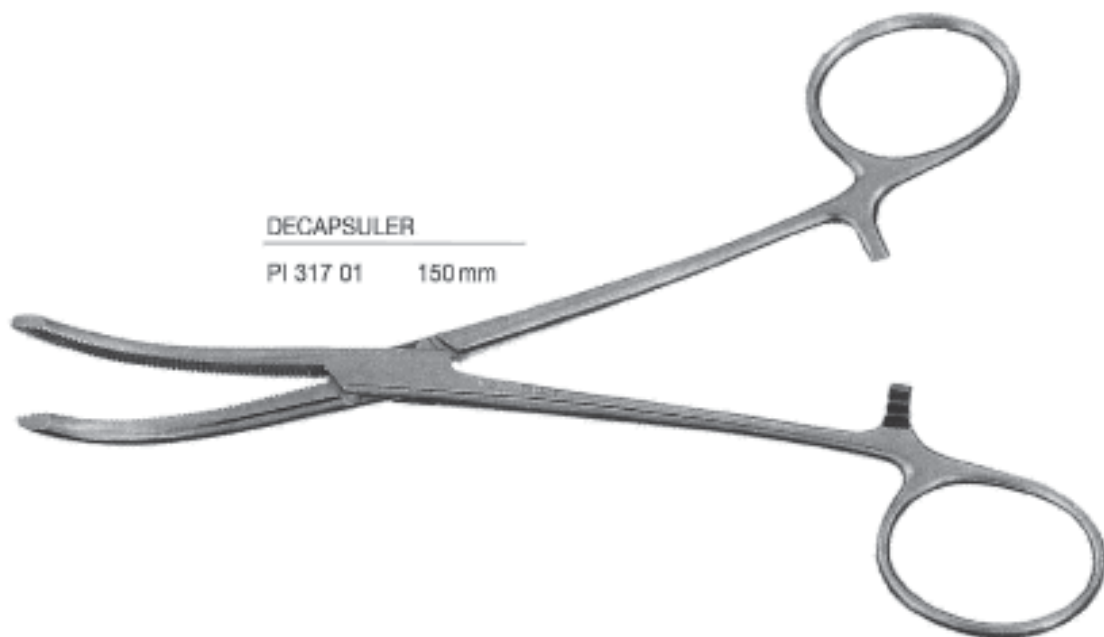

GUNNAR - 185 mm
pour vider les drains

PI 317 03

Diamètre maximum
du tuyau : 17 mm

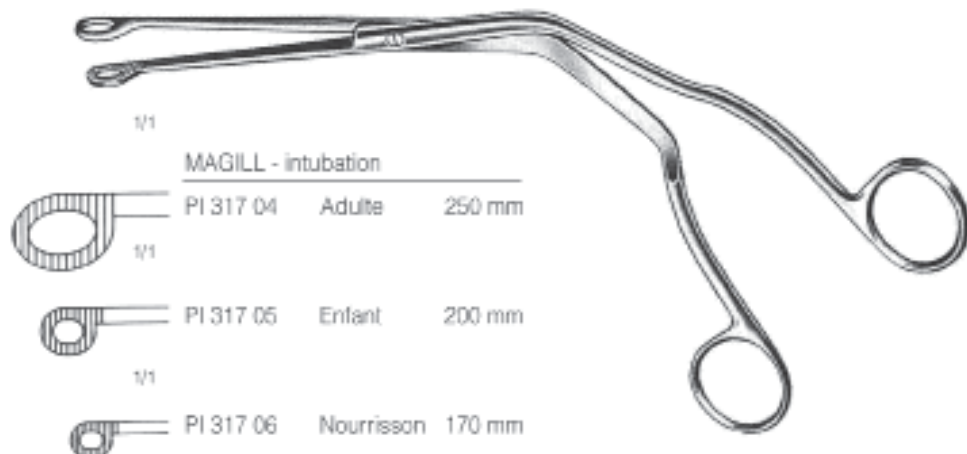

1/1

MAGILL - intubation



1/1

PI 317 04 Adulte 250 mm



1/1

PI 317 05 Enfant 200 mm



PI 317 06 Nourrisson 170 mm

PI 317 07 Prématuré 120 mm mors 4,5 mm



PINCES ECHARDES - ENVIES - EPILER

ECHARDES

1/1



PI 319 01 100 mm

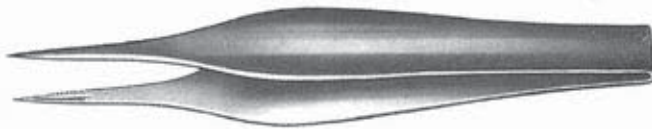

FEILCHENFELD - 115 mm

PI 319 02

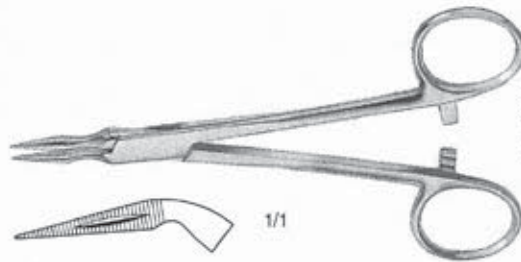

STIEGLITZ

PI 319 03 coudée 140 mm

1/1



WALTER

PI 319 04 courbe 110 mm

PINCE A EPILER - 80 mm

PI 319 09 mors biais

PI 319 10 mors carré

PI 319 11 mors rond

3/4



COUPE-FILS ET BROCHES



HERCULE

- Plaquettes de TUNGSTENE interchangeables
- Les patins caoutchouc, qui retiennent la partie coupée, sont interchangeables.

PI 320 04

180 mm
Coupe maximum de 2 mm pour fil dur

PI 320 01

230 mm
Coupe maximum de 3 mm pour fil dur

PI 320 09

280 mm
Coupe maximum de 3 mm pour fil dur

PI 320 02

Paire de plaquettes de TUNGSTENE
Livrée avec 4 vis et la clé

PI 320 03

Paire de patins caoutchouc
Livrée avec vis



PINCES FILS D'ACIER

COUPE-FILS ET BROCHES

PI 320 05 120 mm - TUNGSTENE
Diamètre maxi : 0,7 mm

PI 320 06 140 mm - TUNGSTENE
Diamètre maxi :
pour fil dur : 1.0 mm
pour fil mou : 1.5 mm



PI 320 07 215 mm - TUNGSTENE
Diamètre maxi :
pour fil dur : 2.0 mm
pour fil mou : 3.5 mm

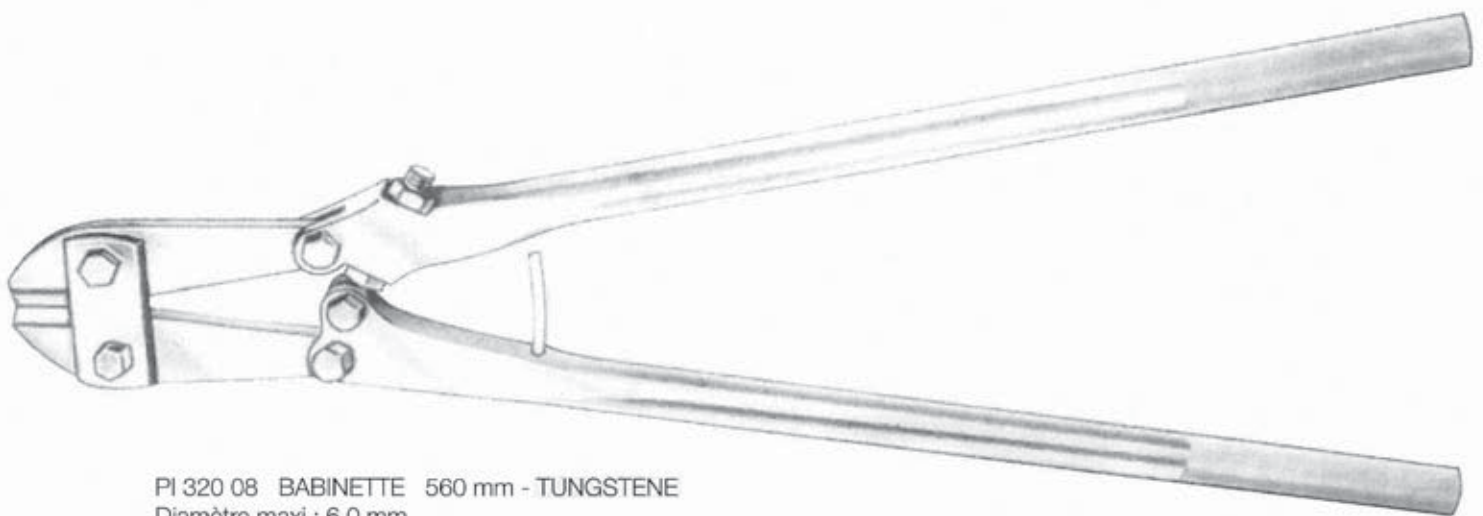

PI 320 08 BABINETTE 560 mm - TUNGSTENE
Diamètre maxi : 6,0 mm



COUPE - FILS ET BROCHES

PI 321 01 150 mm
Diamètre maxi:
pour fil dur: 1.5 mm
pour fil mou: 2.0 mm

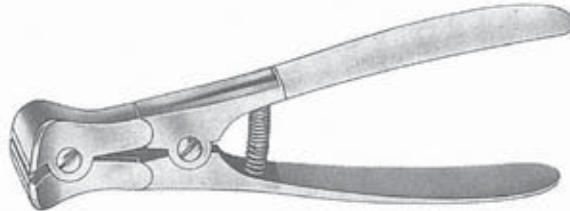

PI 321 02 160 mm
Diamètre maxi:
pour fil dur: 1.5 mm
pour fil mou: 2.0 mm

PI 321 05 220 mm - TUNGSTENE
Diamètre maxi:
pour fil dur: 2.0 mm
pour fil mou: 3.0 mm

PI 321 06 180 mm - TUNGSTENE
Diamètre maxi:
pour fil dur: 1.5 mm
pour fil mou: 2.0 mm

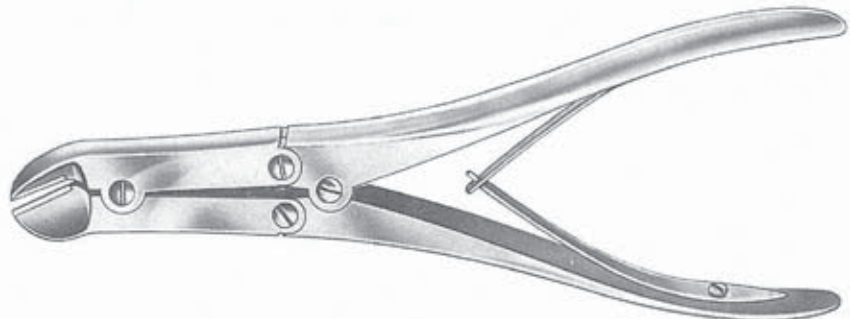



PINCES FILS D'ACIER

EXTRACTION



PI 322 01 130 mm
PI 322 02 180 mm

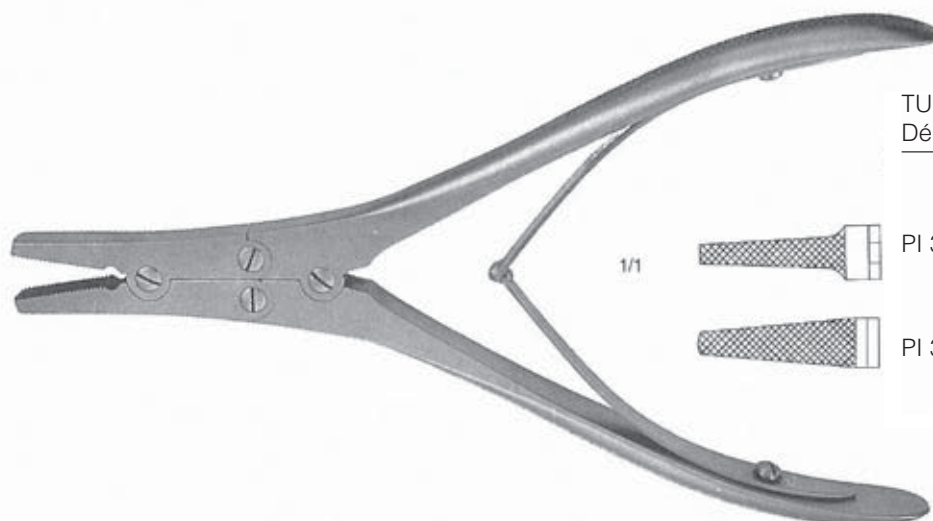

TUNGSTENE
Démultipliée - 180 mm

largeur

PI 322 03 2,5 mm

PI 322 04 3,5 mm

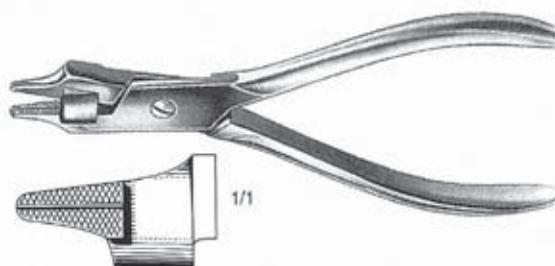

Extraction et coupe - 150 mm - PI 322 05

- Coupe maxi pour fil dur : 1,0 mm
pour fil mou : 1,5 mm



PREHENSION

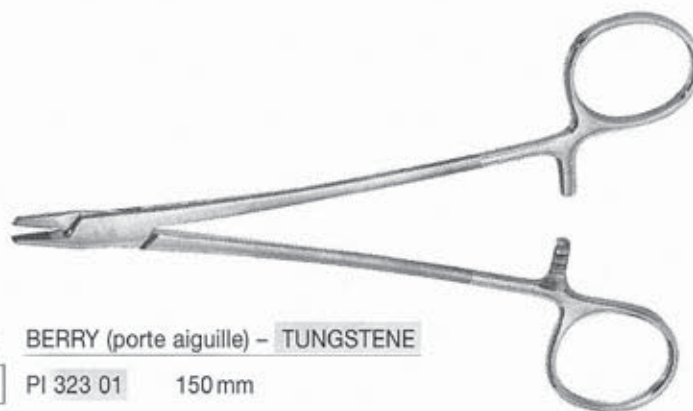

1/1 BERRY (porte aiguille) - TUNGSTENE

PI 323 01 150 mm

1/1 PI 323 02 195 mm

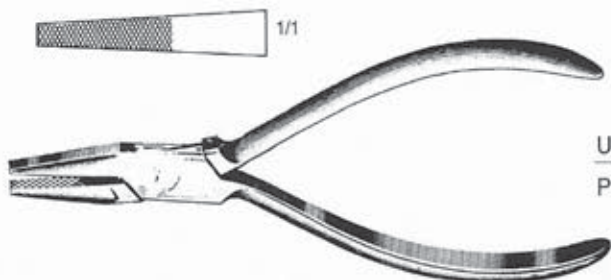

UNIVERSELLE
PI 323 03 140 mm



UNIVERSELLE - 185 mm
PI 323 06 = inox



UNIVERSELLE avec blocage - 180 mm

PI 323 07 = inox

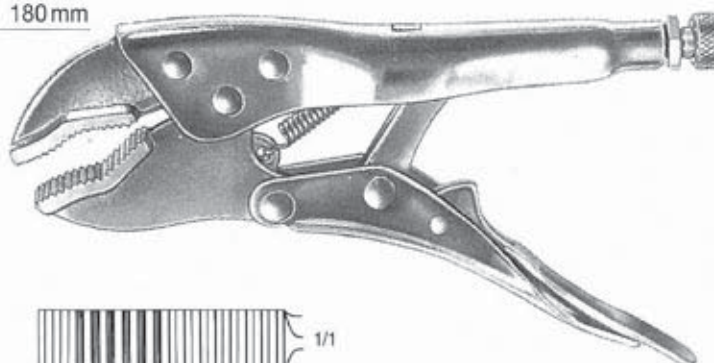



PINCES GOUGES

DOUBLE ARTICULATION

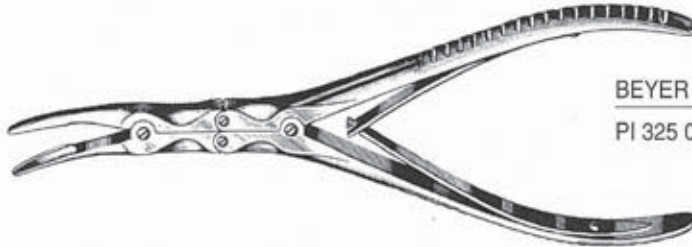

BEYER - 180 mm courbe

PI 325 01 mors de 3 mm



1/1

BOHLER - 150 mm courbe

mors



PI 325 02 2 mm

PI 325 03 3 mm

PI 325 04 4 mm

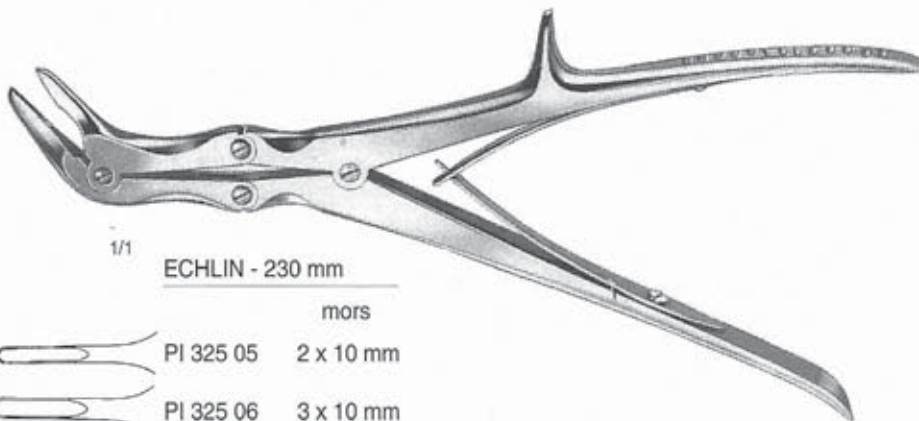

1/1

ECHLIN - 230 mm

mors



PI 325 05 2 x 10 mm

PI 325 06 3 x 10 mm

PI 325 07 4 x 10 mm



DOUBLE ARTICULATION

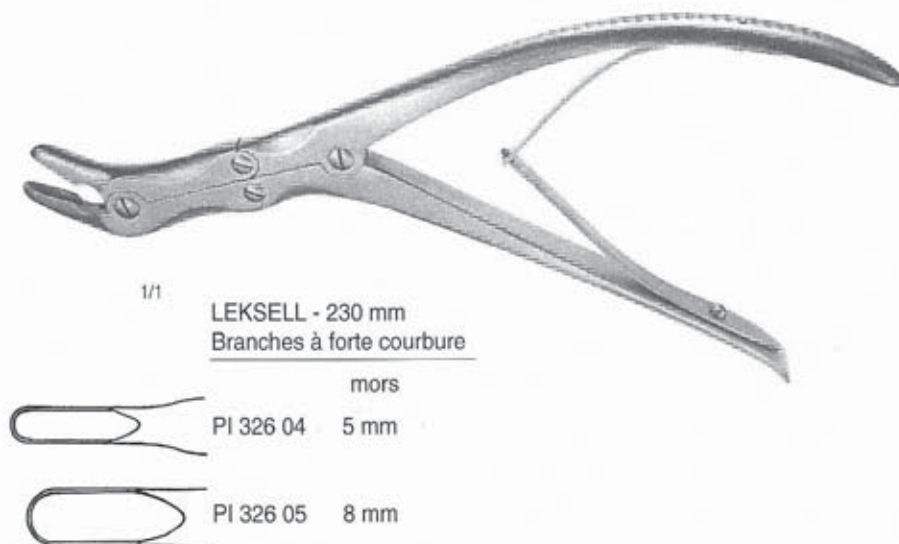
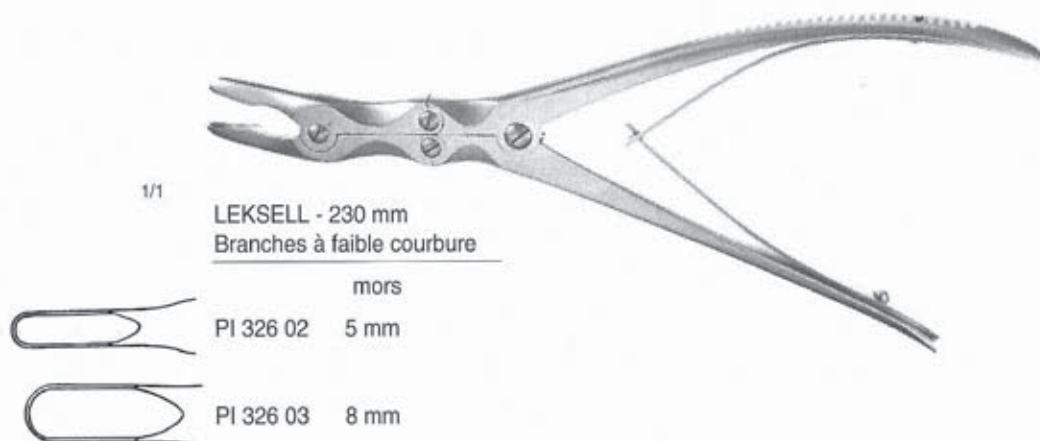



PINCES GOUGES

DOUBLE ARTICULATION

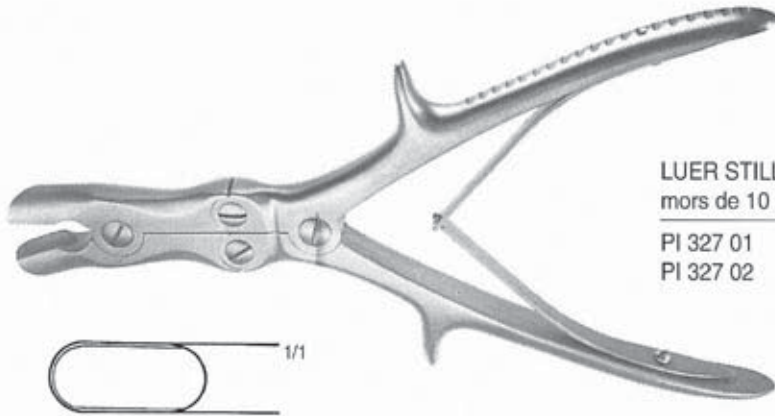

LUER STILLE - 220 mm
mors de 10 mm

PI 327 01 droite
PI 327 02 courbe

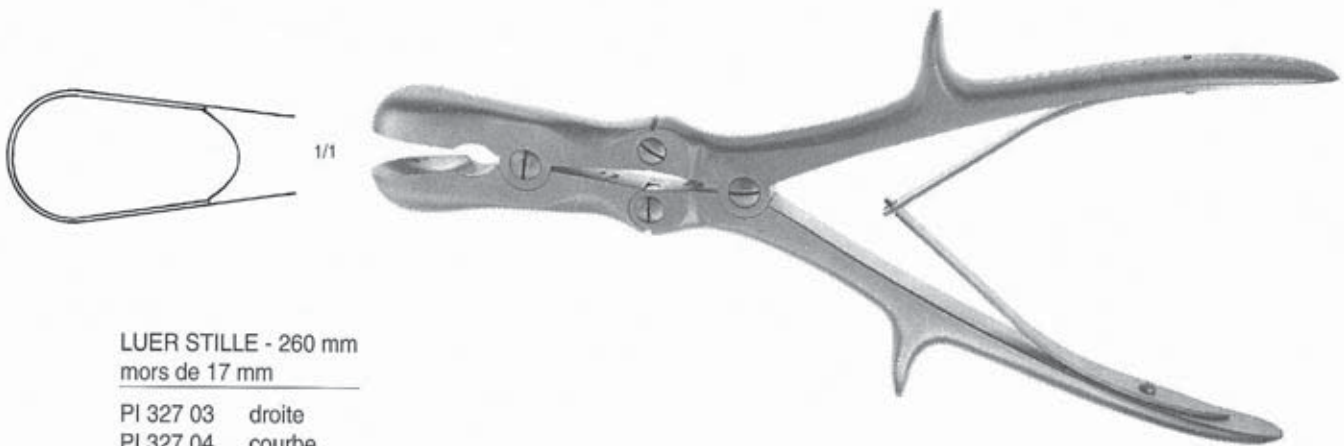

LUER STILLE - 260 mm
mors de 17 mm

PI 327 03 droite
PI 327 04 courbe

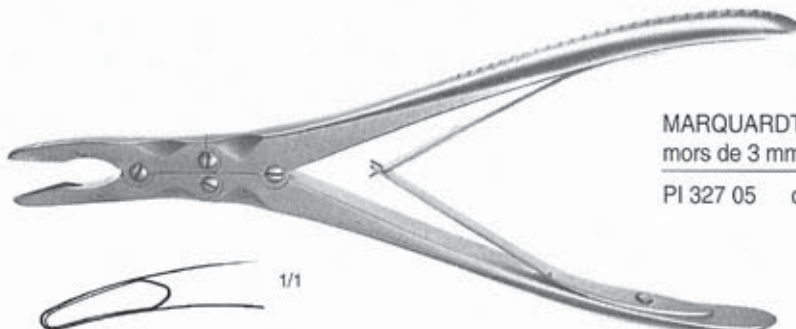

MARQUARDT - 200 mm
mors de 3 mm

PI 327 05 courbe



DOUBLE ARTICULATION

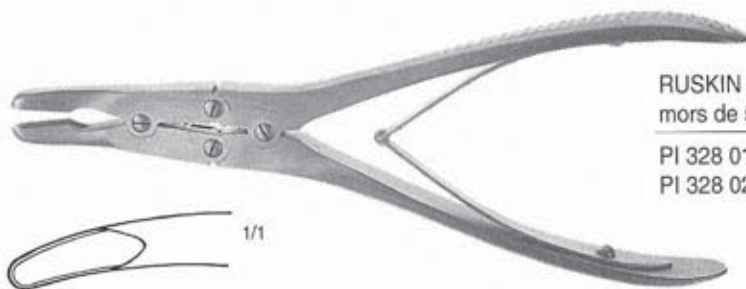

RUSKIN - 190 mm
mors de 5 mm

PI 328 01 droite
PI 328 02 courbe



RUSKIN - 240 mm
mors de 5 mm
PI 328 03 courbe

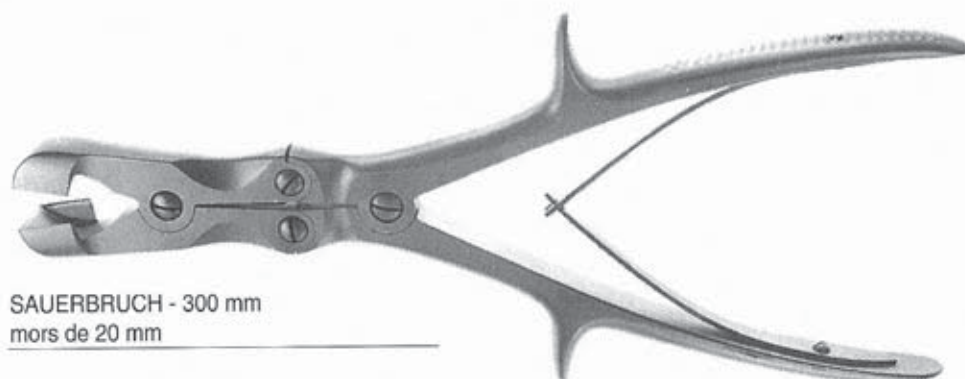
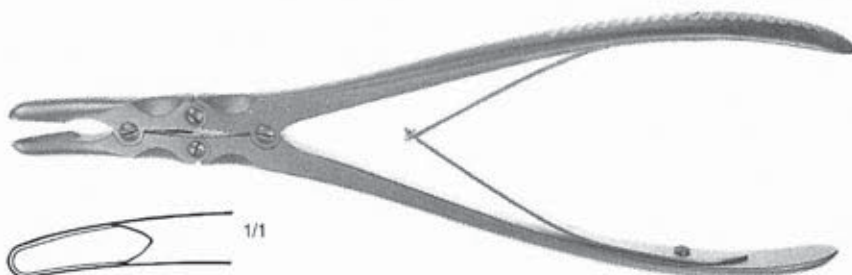

SAUERBRUCH - 300 mm
mors de 20 mm



mors ronds

PI 328 04



mors carrés

PI 328 05 droite



PINCES GOUGES

DOUBLE ARTICULATION

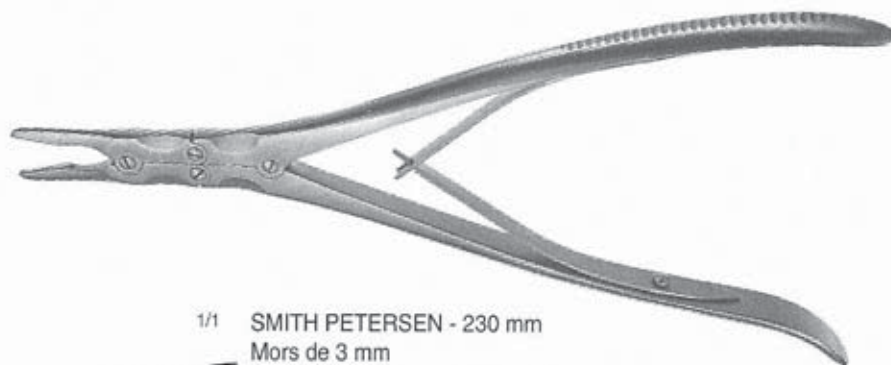

1/1 SMITH PETERSEN - 230 mm
Mors de 3 mm



- PI 329 01 droite
- PI 329 02 faible courbure
- PI 329 03 forte courbure

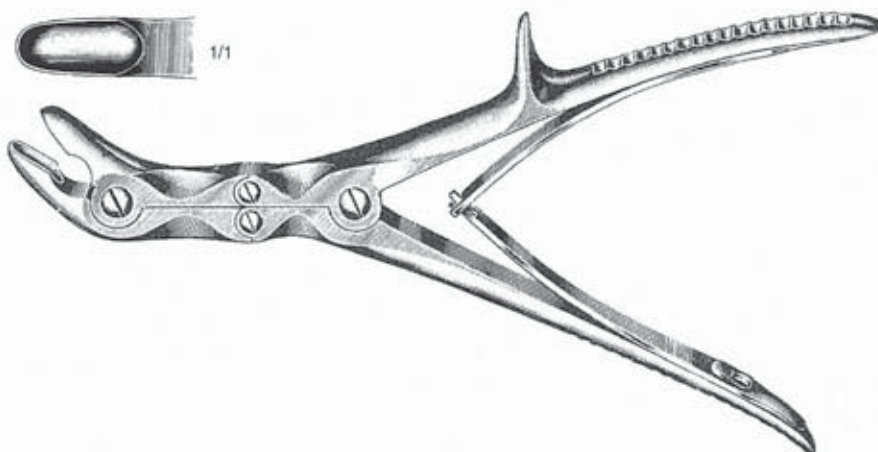

STILLE - 230 mm
Mors de 8 mm
PI 329 04 coudée

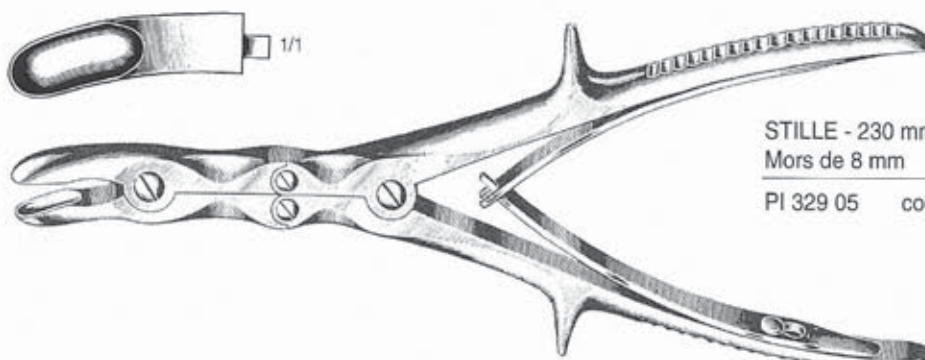

STILLE - 230 mm
Mors de 8 mm
PI 329 05 courbe



DOUBLE ARTICULATION

STILLE - 230 mm
Mors de 8 mm
PI 330 01 droite

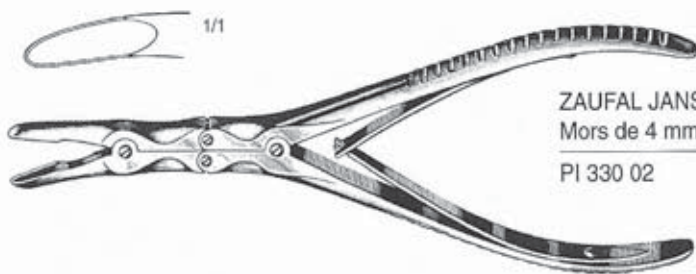

ZAUFAL JANSEN - 180 mm
Mors de 4 mm
PI 330 02 courbe



PINCES GOUGES

SIMPLE ARTICULATION

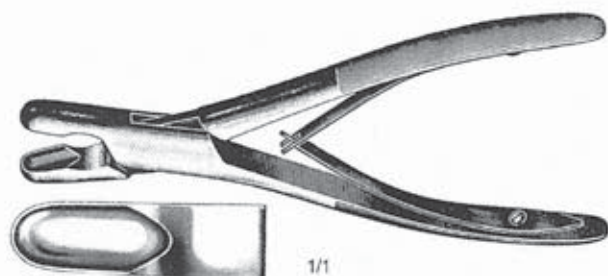

ADSON - 200 mm
Mors de 8 mm
PI 331 01 droite

1/1

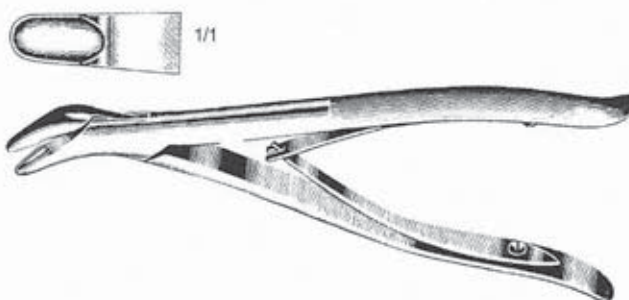

BACON - 200 mm
Mors de 6 mm
PI 331 02 angulée

1/1

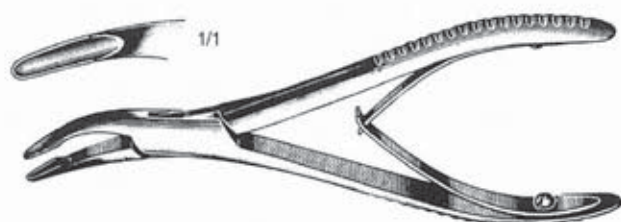

BEYER - 170 mm
Mors de 3 mm
PI 331 03 courbe

1/1

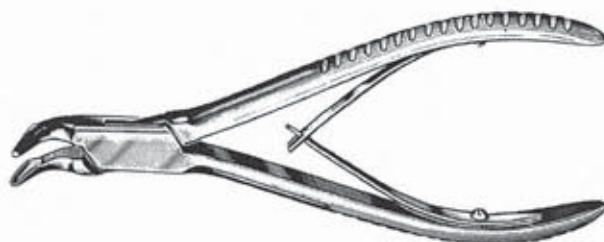

BLUMENTHAL - 160 mm
Mors de 3 mm

1/1

PI 331 04 angulée à 30°

PI 331 05 angulée à 45°



SIMPLE ARTICULATION

CLEVELAND - 170 mm
 Mors de 3,5 mm
 PI 332 01 courbe

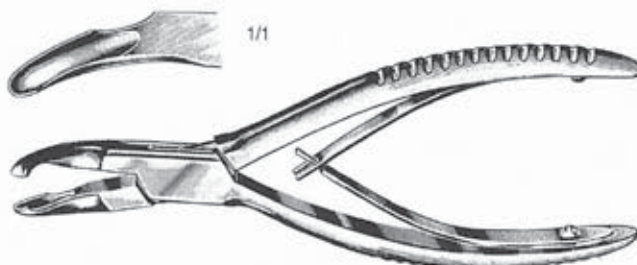

CLOVIS VINCENT (Bécassine)
 Mors longs de 3mm de largeur
 PI 332 02 210 mm
 PI 332 03 260 mm

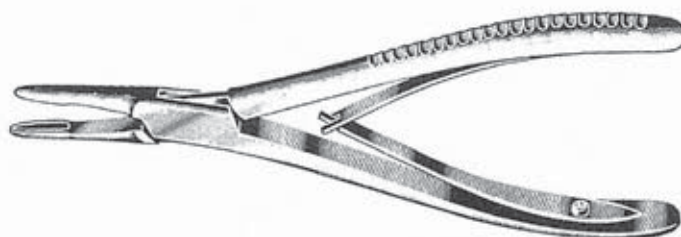

JANSEN - 170 mm
 Mors de 4 mm



PI 332 04 droite



PI 332 05 courbe

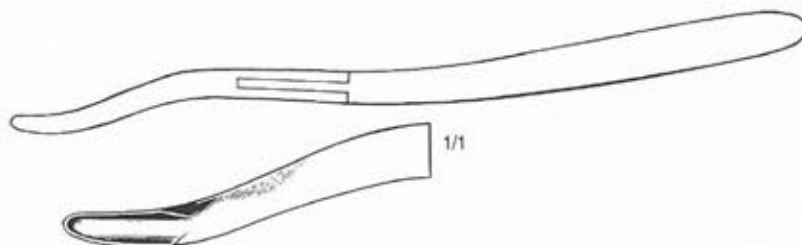

PI 332 06 double courbure



PINCES GOUGES

SIMPLE ARTICULATION



LEMPERT - 190 mm
Mors de 2 mm

PI 333 01 droite
PI 333 02 courbe

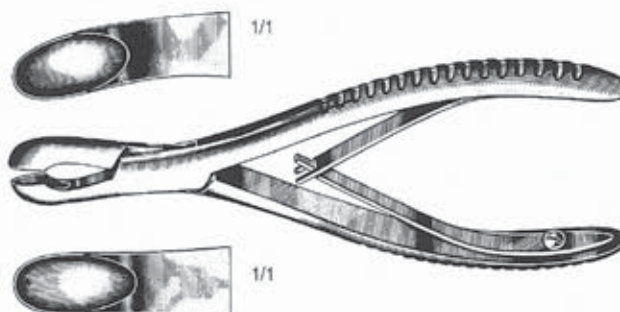

LUER - 170 mm
Mors de 8mm

PI 333 03 droite
PI 333 04 courbe

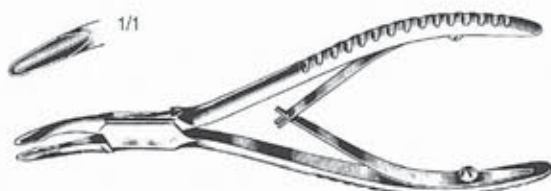

LUER FRIEDMANN - 140 mm
Mors de 2 mm

PI 333 05 courbe

OLIVECRONA - 200 mm
Mors de 4mm

PI 333 06 très courbe

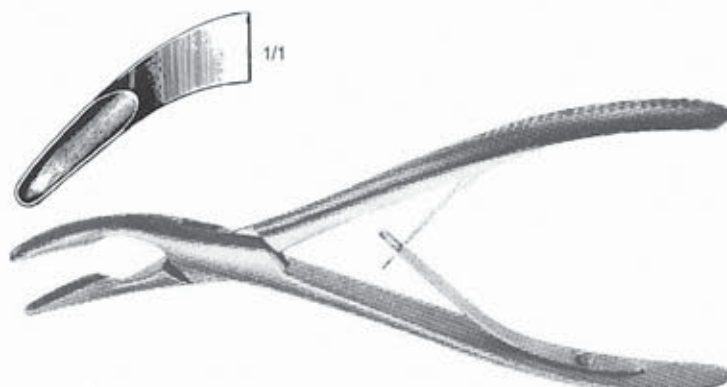



BEACHAM - 260 mm
(perce-membrane)
PI 335 01

1/2

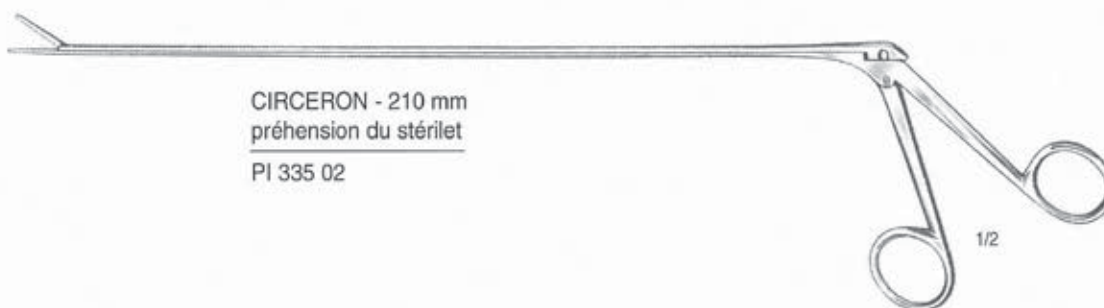

CIRCERON - 210 mm
préhension du stérilet
PI 335 02

1/2



COLLIN - 250 mm
Hystérolabe mors mobiles
PI 335 03

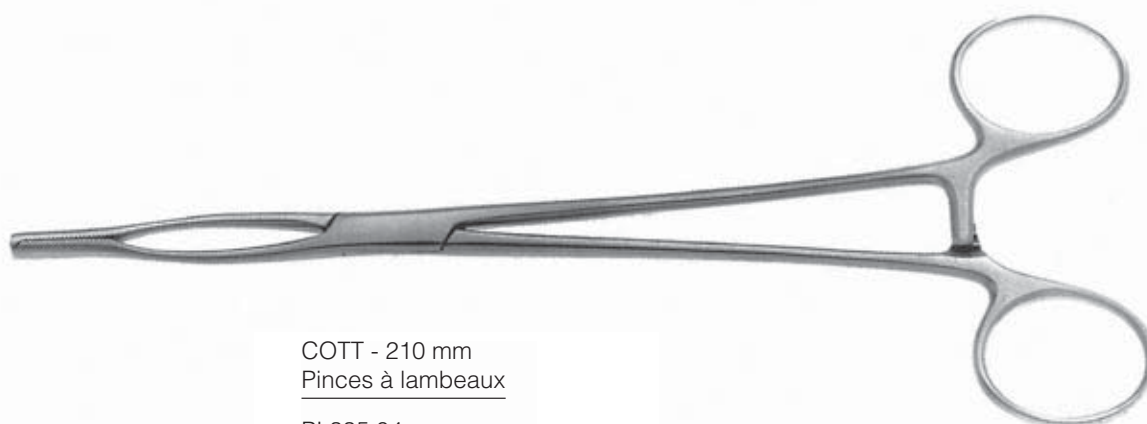

COTT - 210 mm
Pinces à lambeaux

PI 335 04
mors largeur 6 mm



PINCES GYNECO

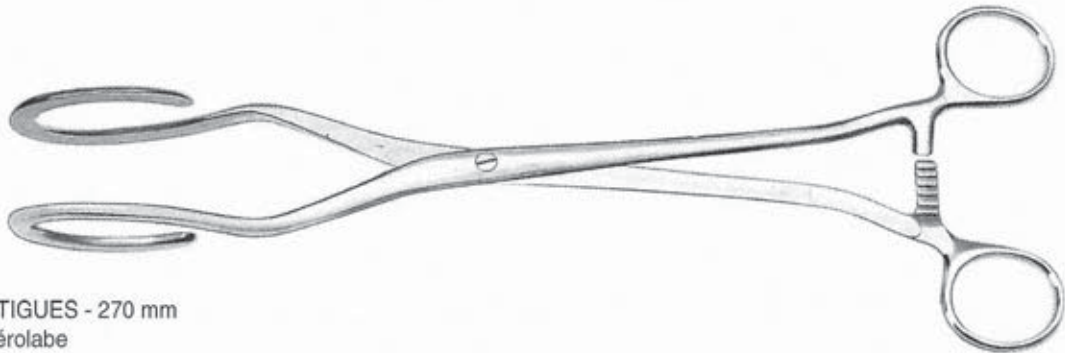

DARTIGUES - 270 mm
Hystérolabe
PI 336 01

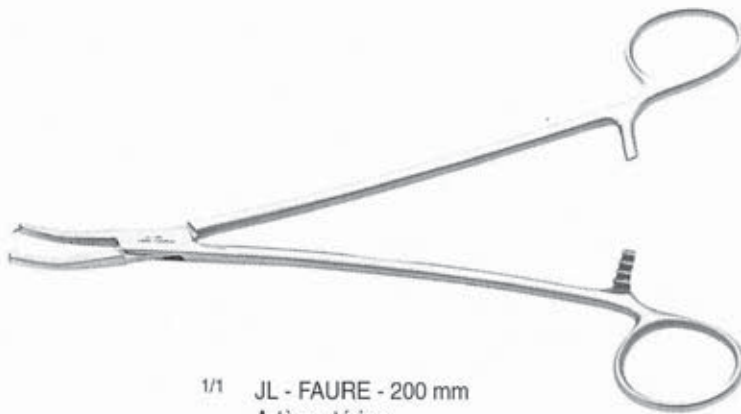

1/1 JL - FAURE - 200 mm
Artère utérine



PI 336 02 modèle fin



PI 336 03 modèle fort

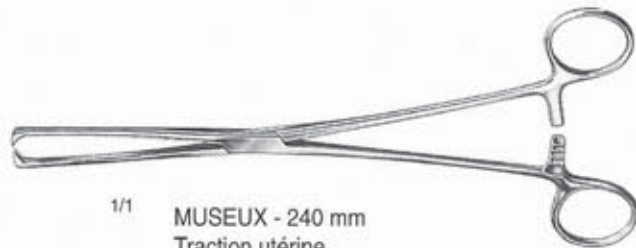

1/1 MUSEUX - 240 mm
Traction utérine

mors



PI 336 04 7 mm



PI 336 05 9 mm



PI 336 06 11 mm

Modèles 180 mm et 200 mm
voir page 365

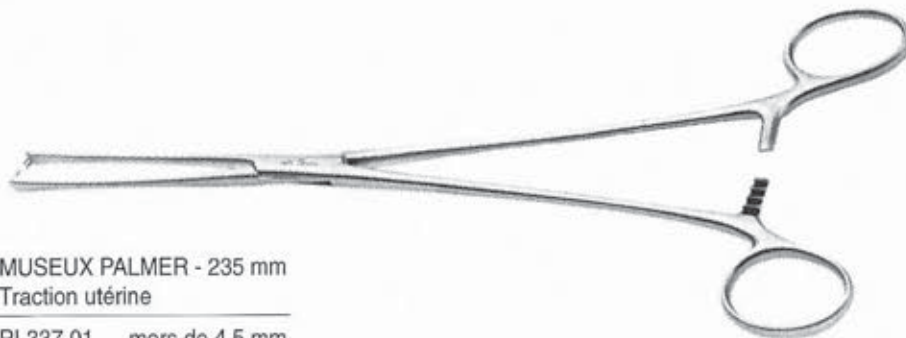

MUSEUX PALMER - 235 mm
Traction utérine

PI 337 01 mors de 4,5 mm



MUSEUX PALMER - Coudée CHERON
235 mm - traction utérine

PI 337 02 mors de 4,5 mm

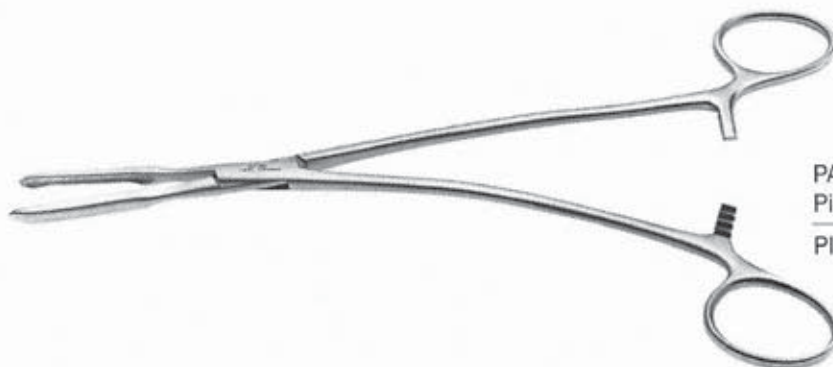

PALMER - 220 mm
Pince à polypes

PI 337 03

PHANEUF - 220 mm
Artère utérine

PI 337 04 droite
PI 337 05 coudée

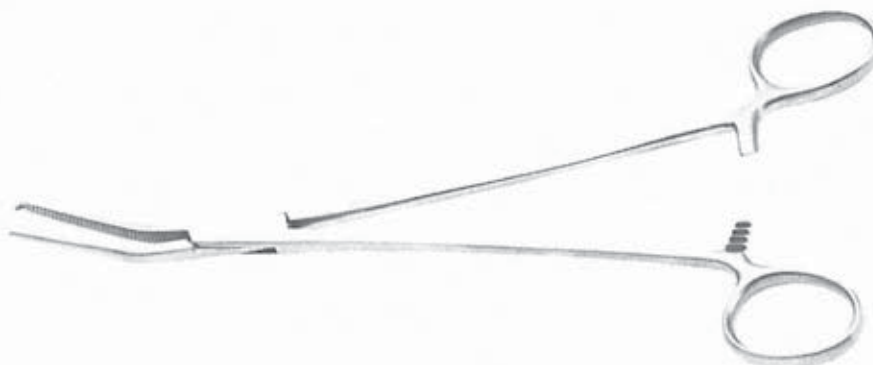



PINCES GYNECO

POZZI - 240 mm
Traction utérine
PI 338 01

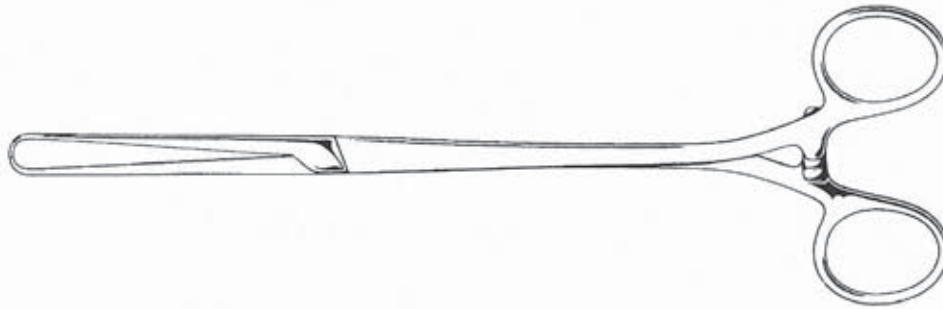

POZZI - 240 mm
Démontable (à doigt)
PI 338 02

POZZI PALMER - 235 mm
Traction utérine
PI 338 03



POZZI PALMER - Coudée - CHERON
235 mm - traction utérine
PI 338 04



PINCES GYNECO



ROCHARD - 210 mm
Artère utérine

PI 339 01 coudée à griffes

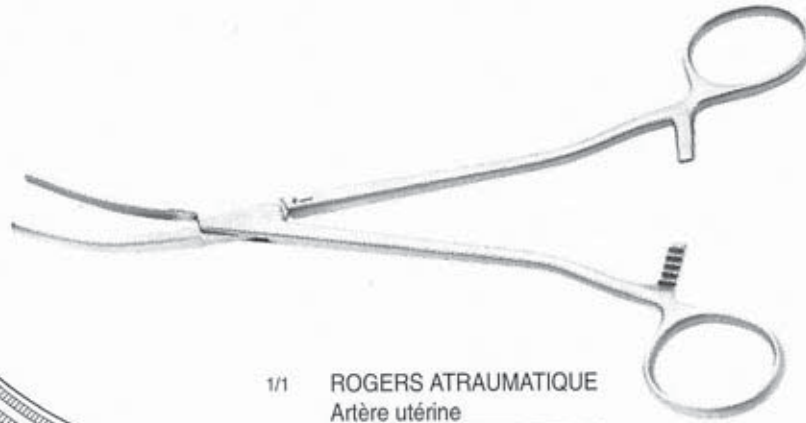

1/1 ROGERS ATRAUMATIQUE
Artère utérine

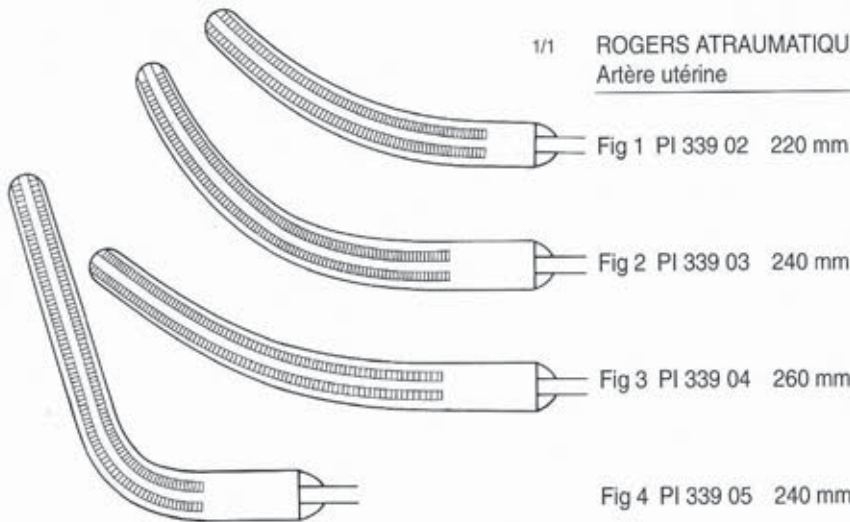

Fig 1 PI 339 02 220 mm

Fig 2 PI 339 03 240 mm

Fig 3 PI 339 04 260 mm

Fig 4 PI 339 05 240 mm

SCHROEDER - 250 mm
Traction utérine

PI 339 06 droite
PI 339 07 courbe

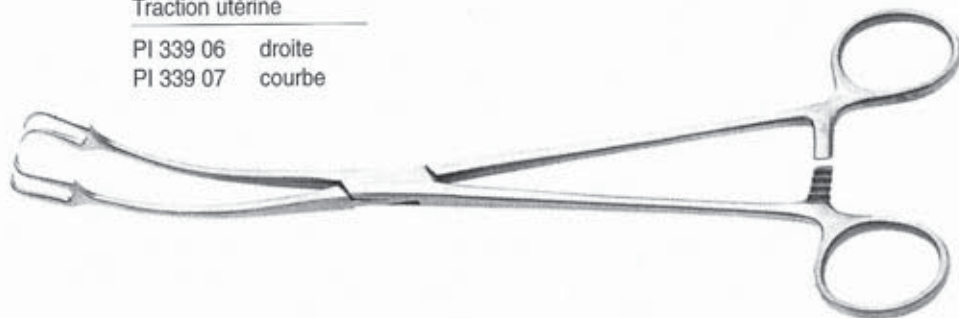



PINCES GYNECO

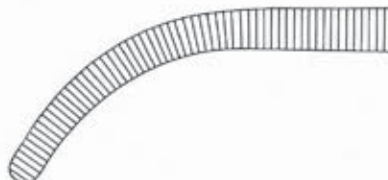
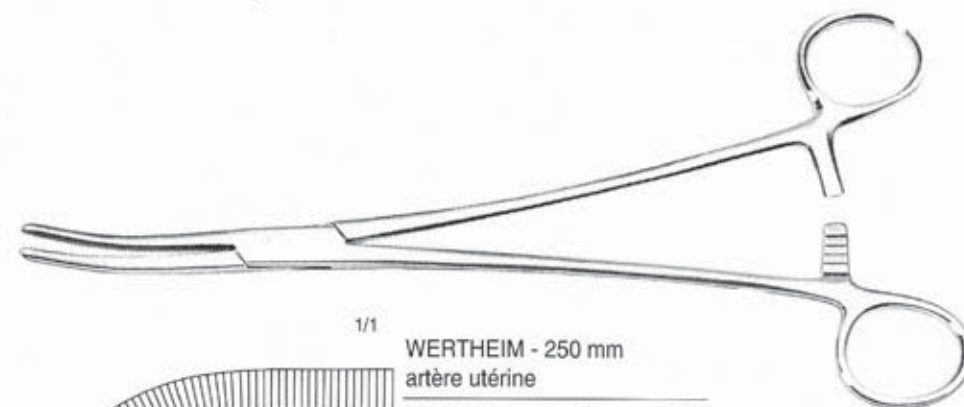
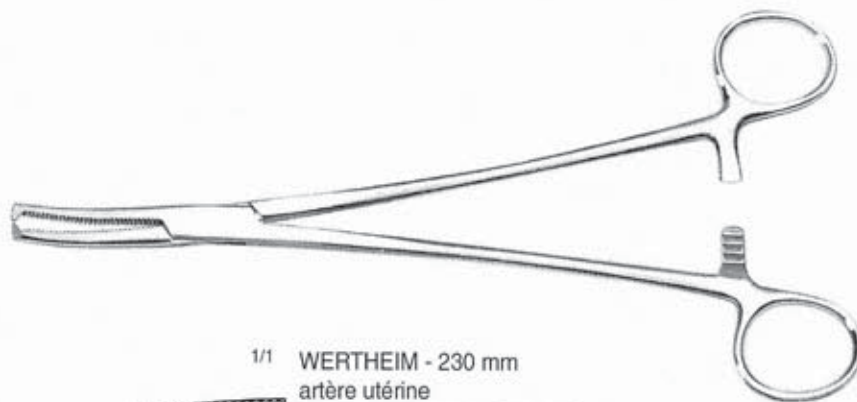
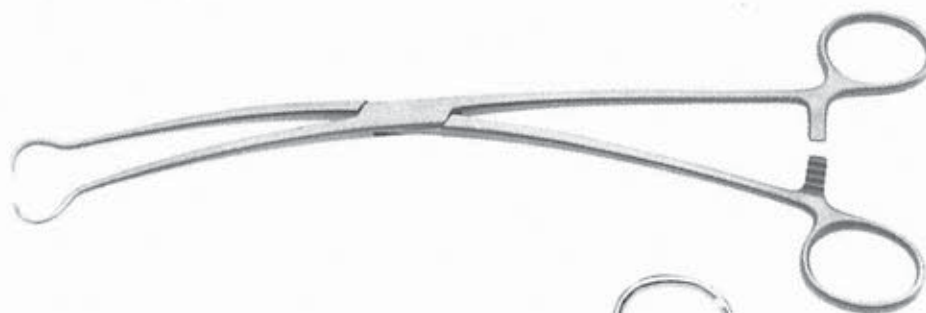



PINCES HEMOSTATIQUES

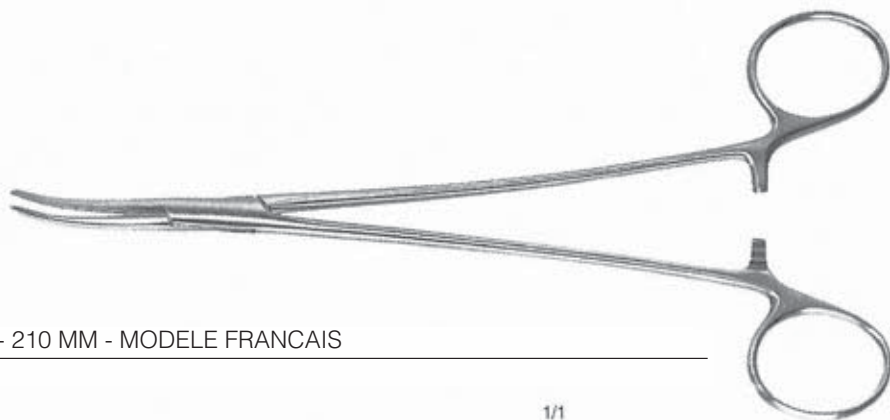

BENGOLEA - 210 MM - MODELE FRANCAIS

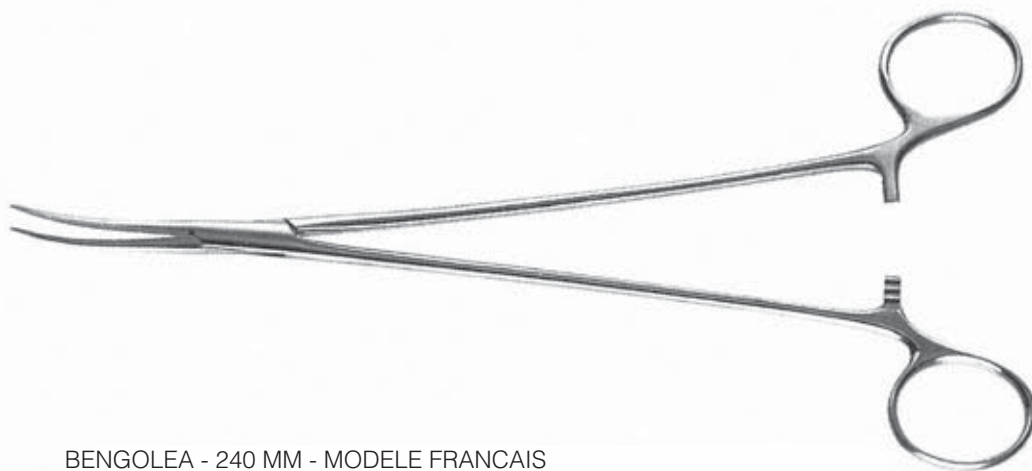
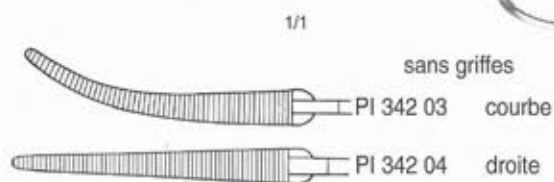
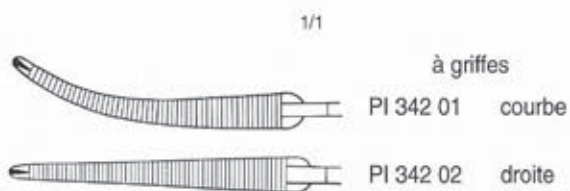

BENGOLEA - 240 MM - MODELE FRANCAIS

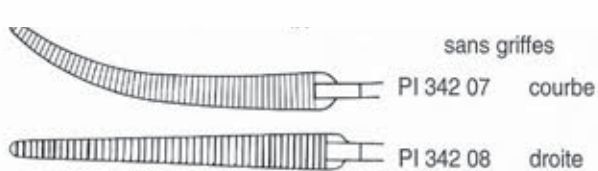
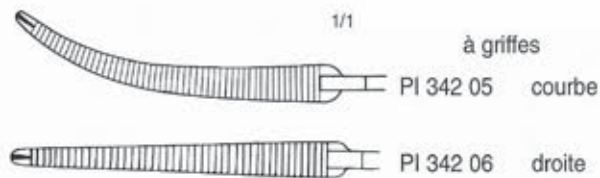

BENGOLEA - 300 mm - courbe - (non illustré)

à griffes	sans griffes
PI 342 09	PI 342 10





PINCES HEMOSTATIQUES



BENGOLEA - 240 mm - courbe **UP-LINE**[®]



BENGOLEA SUEDOISE - 240 mm - courbe **UP-LINE**[®]





PINCES HEMOSTATQUES

CHRISTOPHE - 160 mm

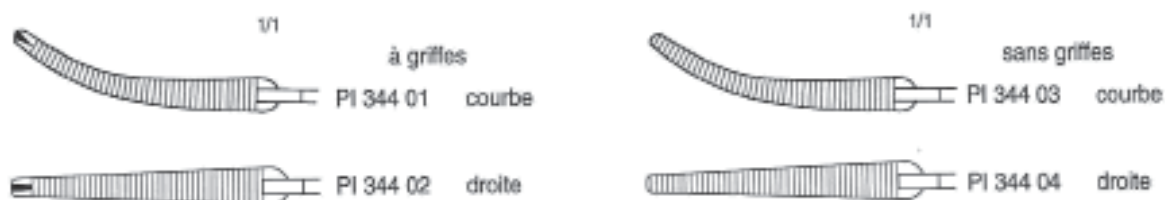

CHRISTOPHE - 160 mm **UP-LINE®**





PINCES HEMOSTATIQUES

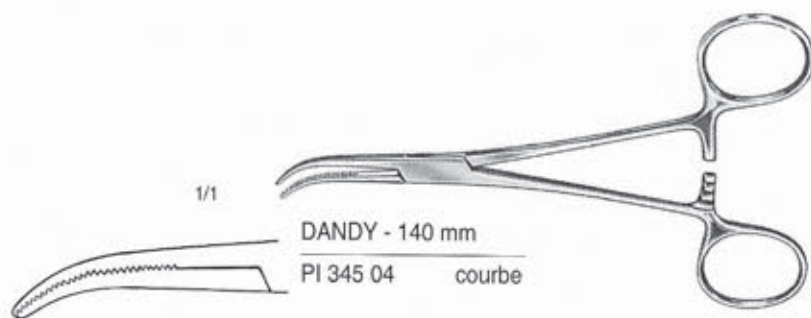
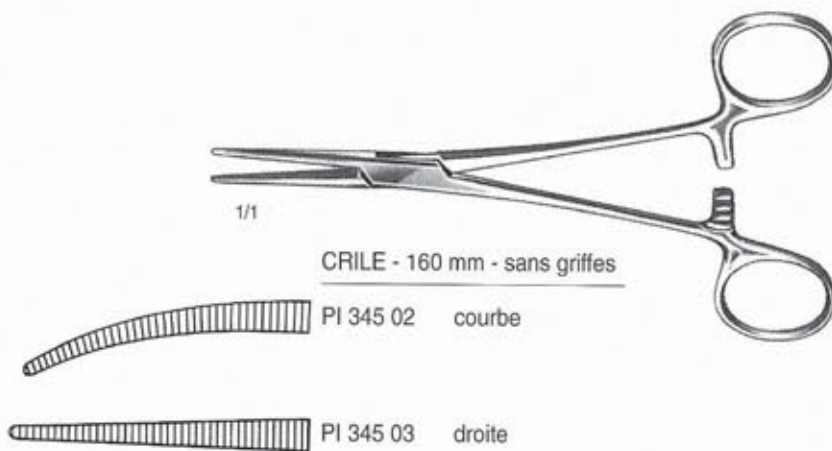
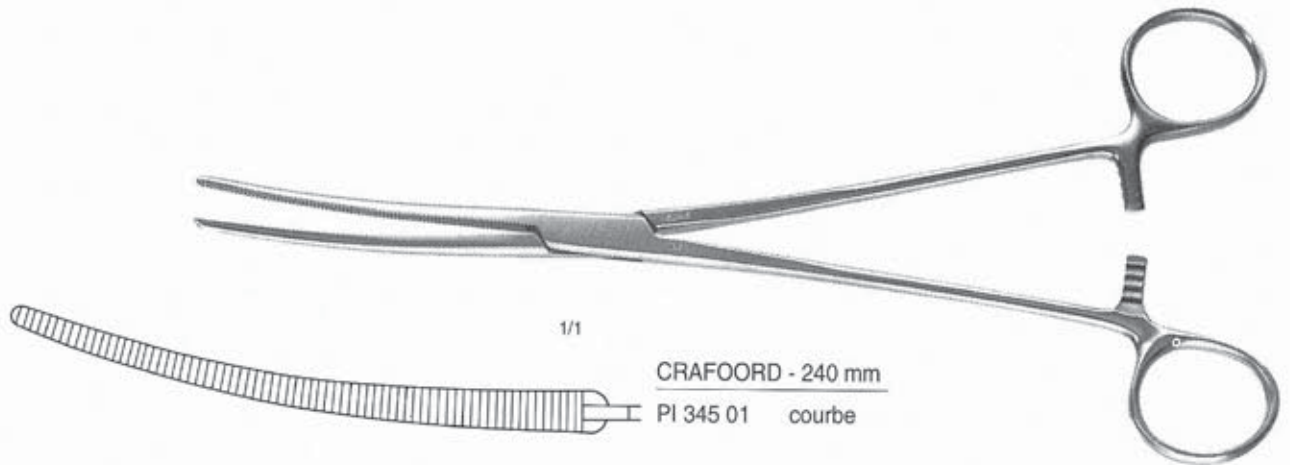



PINCES HEMOSTATIQUES

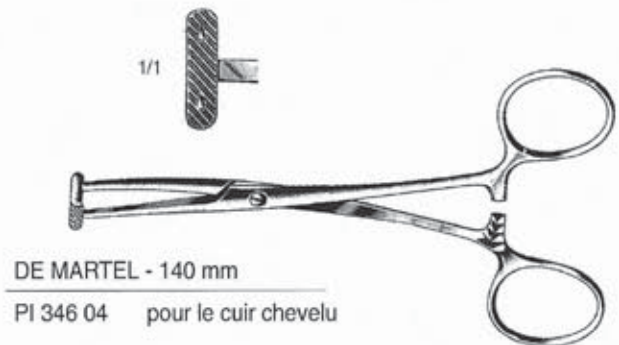
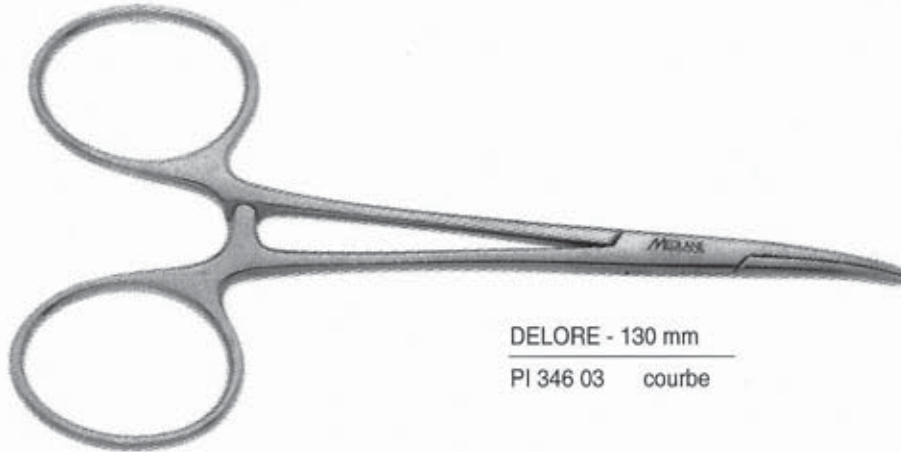
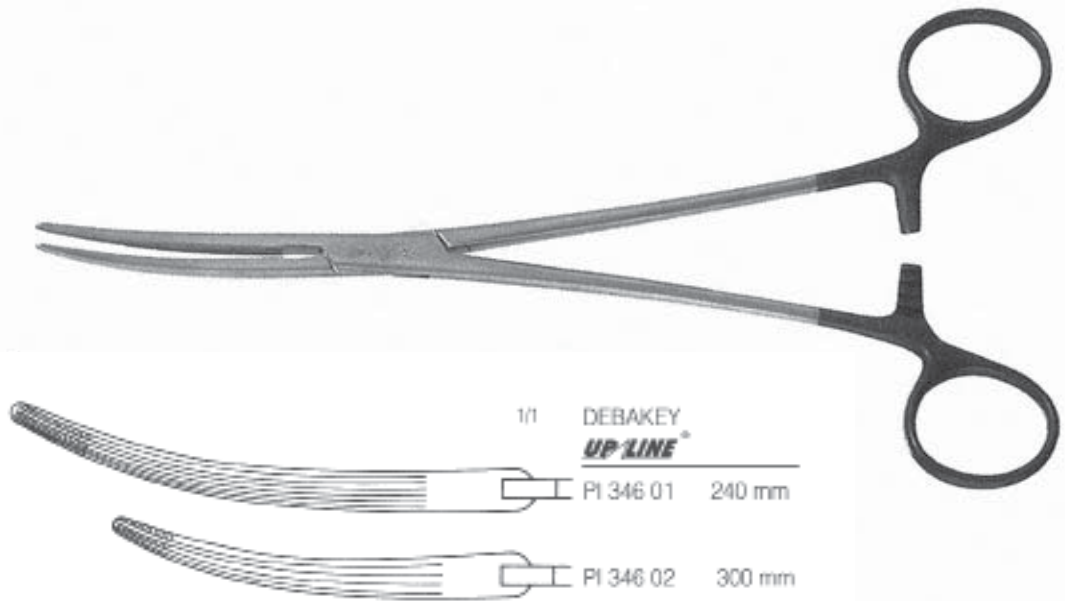



PINCES HEMOSTATQUES

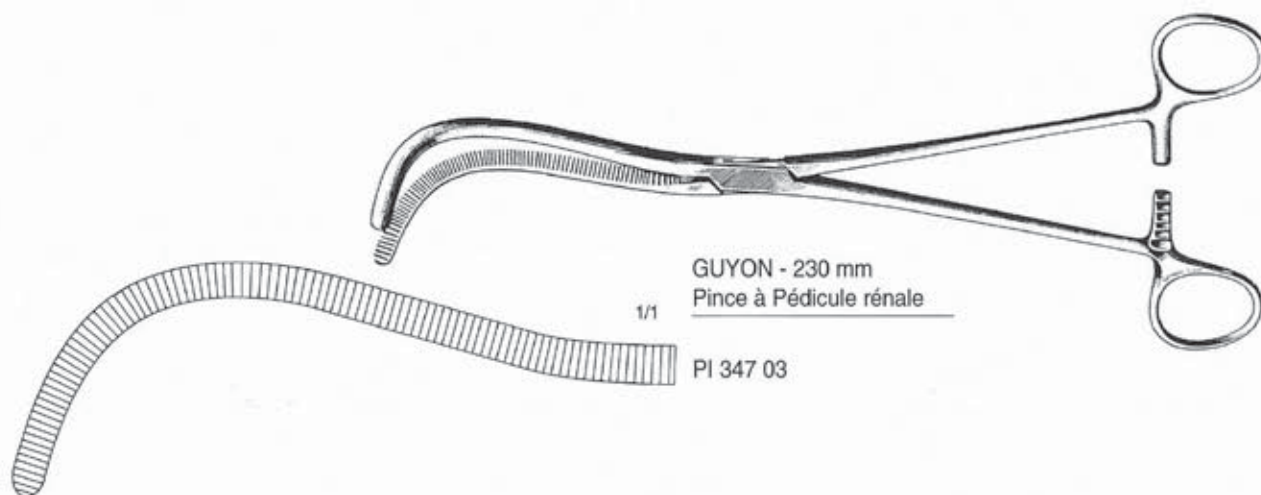
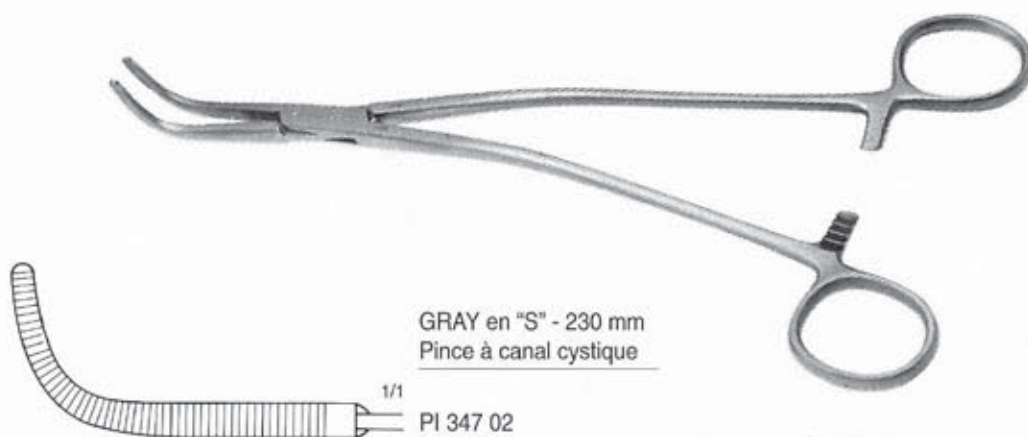
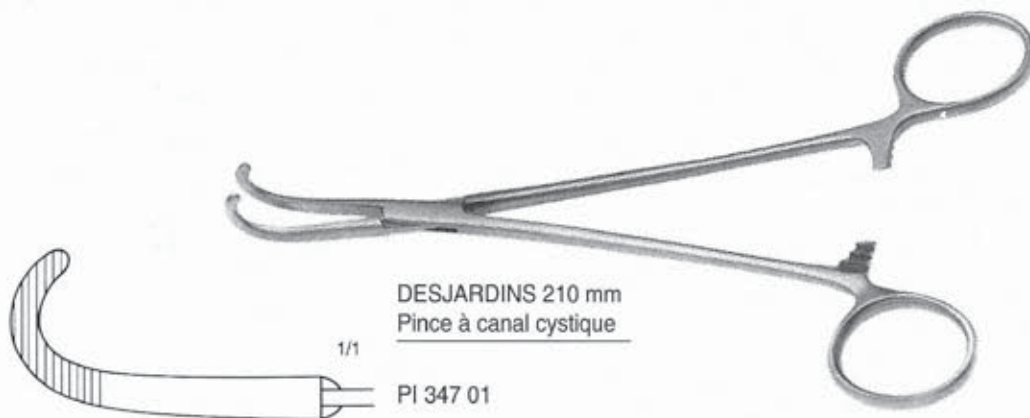



PINCES HEMOSTATQUES

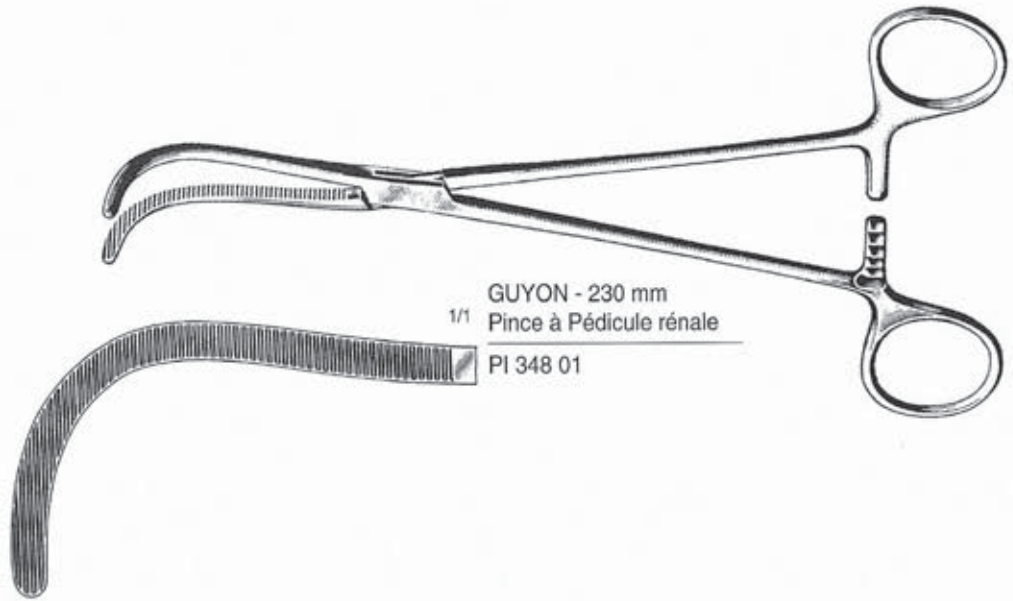

GUYON - 230 mm
1/1 Pince à Pédicule rénale
PI 348 01

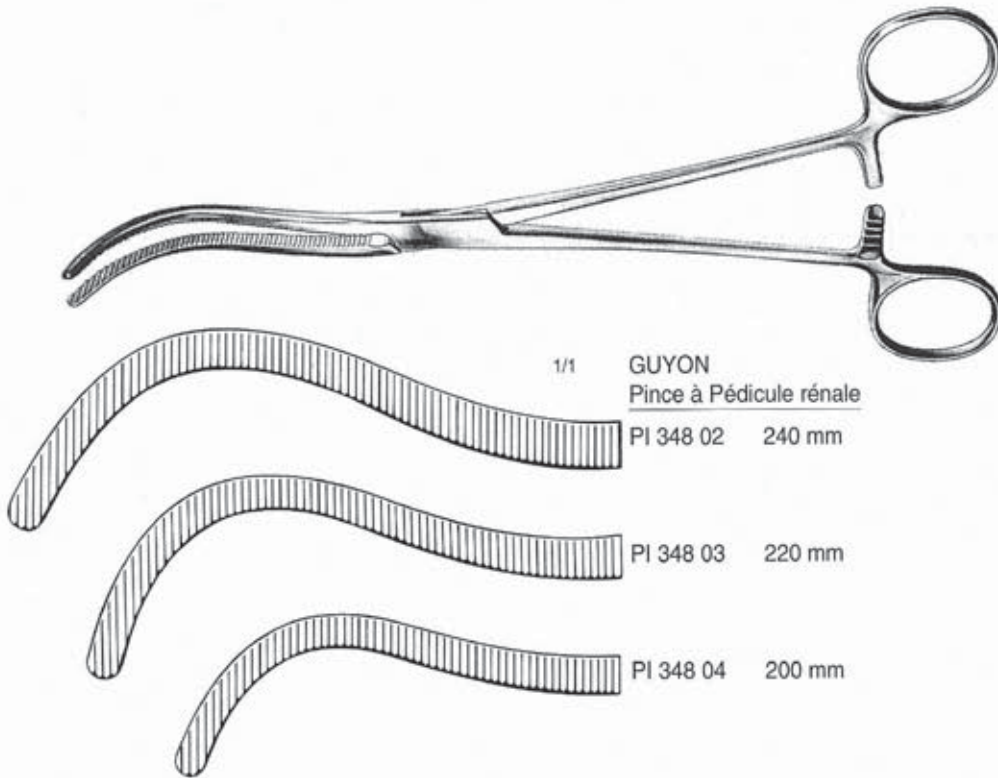

1/1 GUYON
Pince à Pédicule rénale
PI 348 02 240 mm

PI 348 03 220 mm

PI 348 04 200 mm



PINCES HEMOSTATIQUES



HALSTEAD - MODELE FRANCAIS

courbe à griffes

courbe sans griffes

droite à griffes

droite sans griffes

100 mm



PI 349 01



PI 349 02



PI 349 03



PI 349 04

120 mm



PI 349 05



PI 349 06



PI 349 07



PI 349 08

120 mm micro



PI 349 09



PI 349 10



PI 349 11



PI 349 12



PINCES HEMOSTATIQUES



HALSTEAD **UP/LINE**®

courbe à griffes

courbe sans griffes

droite à griffes

droite sans griffes

120 mm



UL 350 01



UL 350 02



UL 350 03

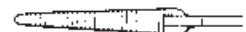

UL 350 04

120 mm micro



UL 350 05



UL 350 06



UL 350 07



UL 350 08



PINCES HEMOSTATQUES

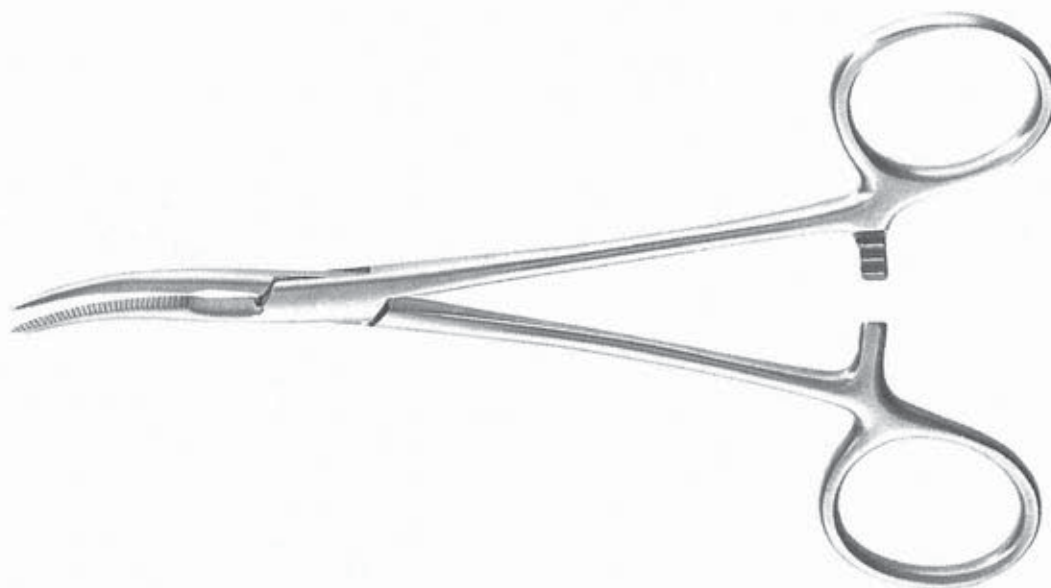

KELLY MODELE FRANCAIS

courbe

droite



PI 351 01

140 mm



PI 351 02



PI 351 03

160 mm



PI 351 04



PI 351 05

180 mm



PI 351 06



PI 351 07

210 mm



PI 351 08



PINCES HEMOSTATIQUES

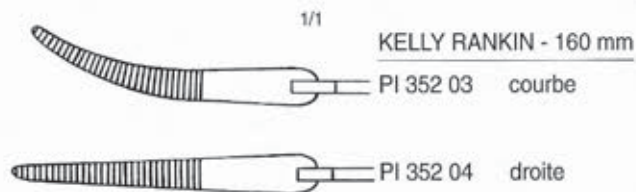
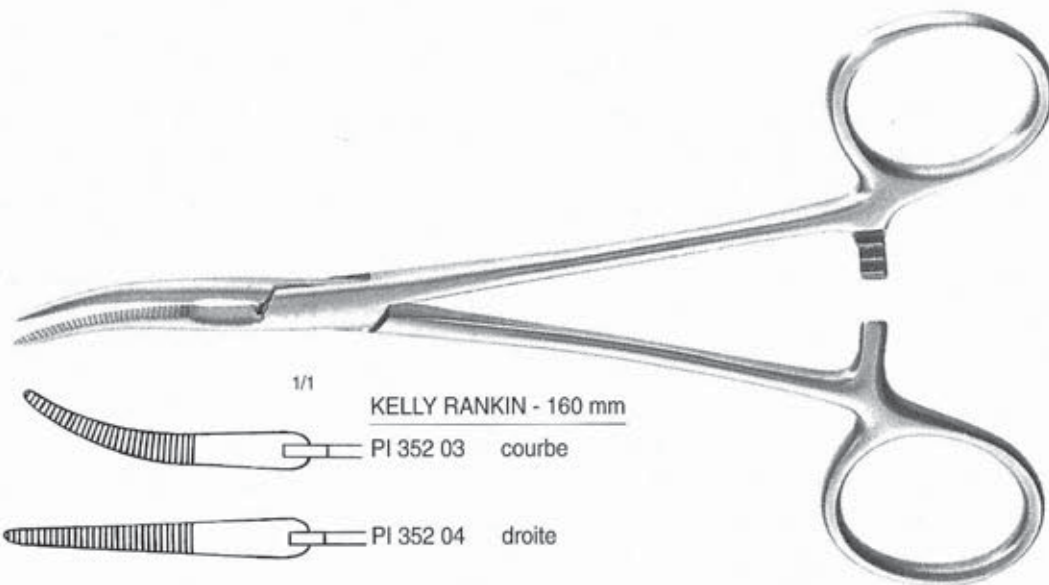
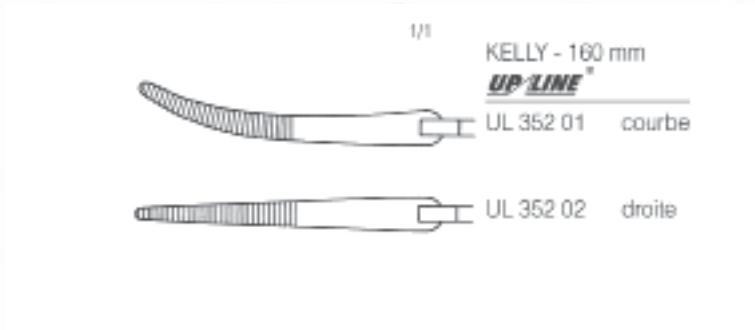
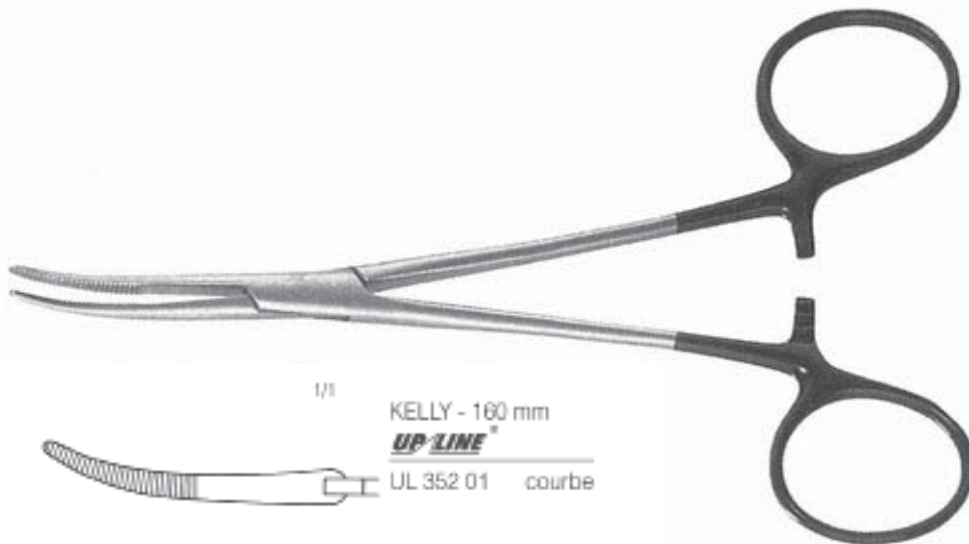



PINCES HEMOSTATIQUES

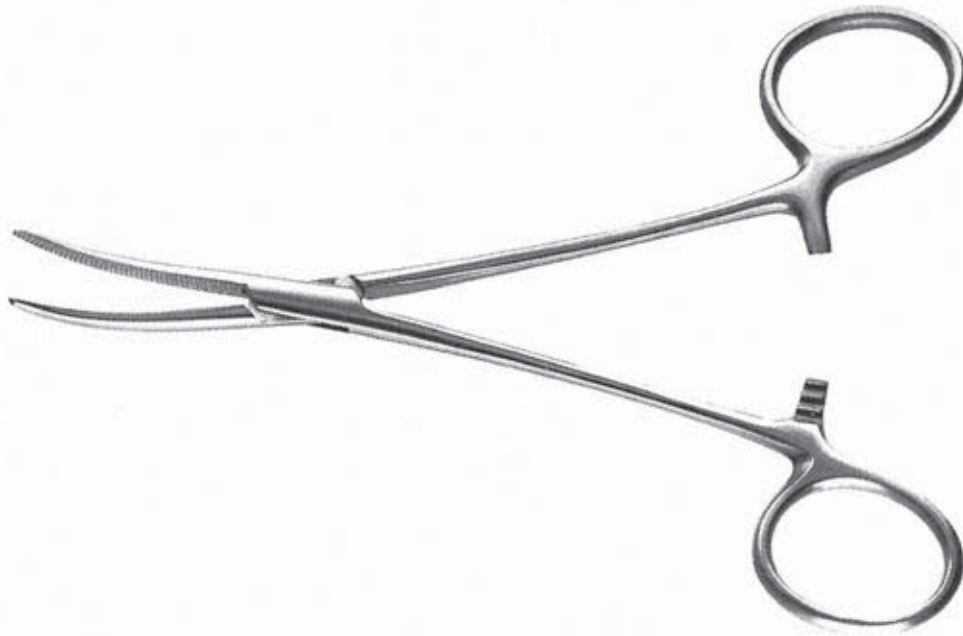

KOCHER - MODELE FRANCAIS

courbe à griffes

courbe sans griffes



140 mm

PI 353 01



150 mm

PI 353 03



180 mm

PI 353 05



210 mm

PI 353 07



240 mm

PI 353 09



PI 353 02



PI 353 04



PI 353 06



PI 353 08



PI 353 10



PINCES HEMOSTATQUES

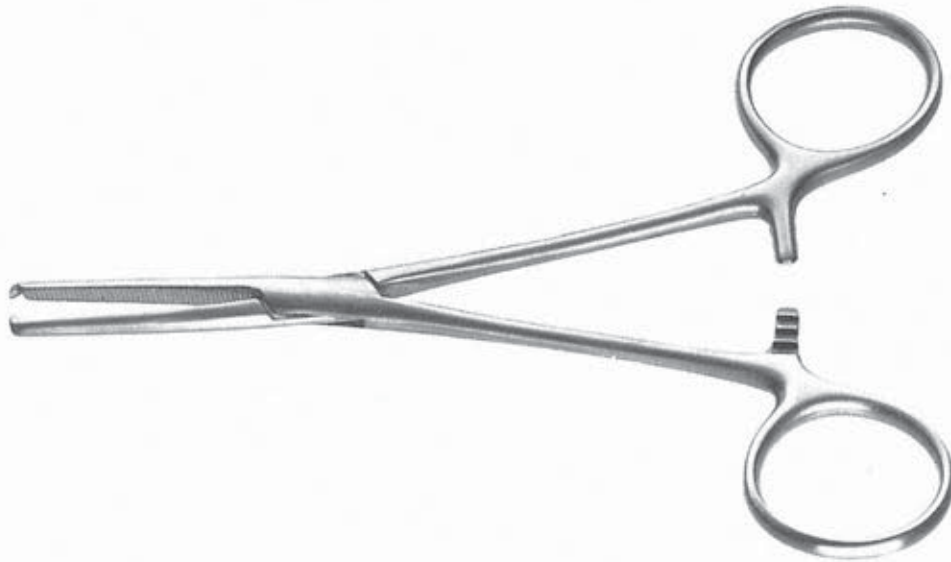

KOCHER - MODELE FRANCAIS

droite à griffes

droite sans griffes



PI 354 01



PI 354 02



PI 354 03



PI 354 04



PI 354 05



PI 354 06



PI 354 07



PI 354 08



PI 354 09



PI 354 10



PINCES HEMOSTATQUES

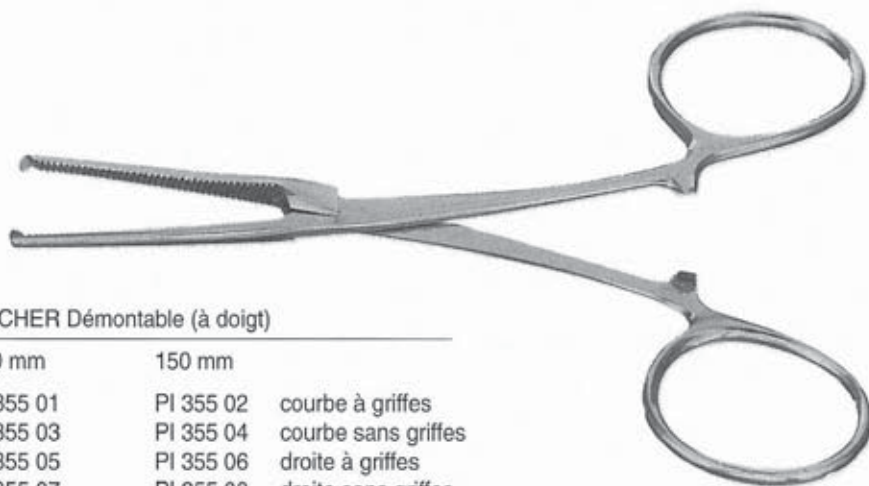

KOCHER Démontable (à doigt)

140 mm	150 mm	
PI 355 01	PI 355 02	courbe à griffes
PI 355 03	PI 355 04	courbe sans griffes
PI 355 05	PI 355 06	droite à griffes
PI 355 07	PI 355 08	droite sans griffes

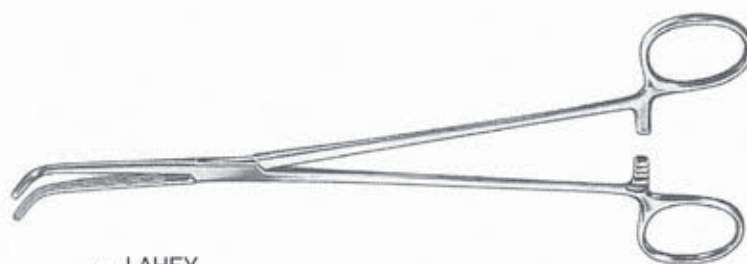

1/1 LAHEY Pincès à voies biliaires



PI 355 09	190 mm
PI 355 10	230 mm

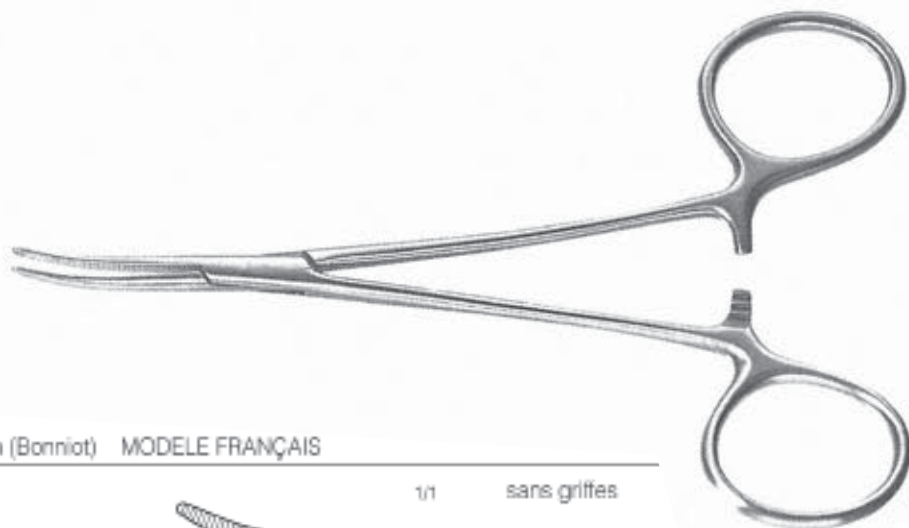

LERICHE - 150 mm (Bonniot) MODELE FRANÇAIS

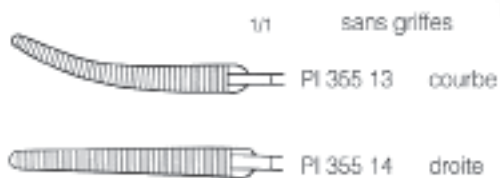
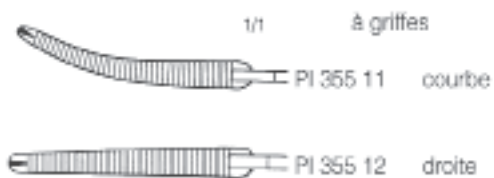



PINCES HEMOSTATQUES



LERICHE - 180 mm - MODELE FRANÇAIS

1/1	à griffes	1/1	sans griffes
	PI 356 01		PI 356 03
	courbe		courbe
	PI 356 02		PI 356 04
	droite		droite



LERICHE - 150 mm **UP-LINE**

1/1	à griffes	1/1	sans griffes
	UL 356 05		UL 356 07
	courbe		courbe
	UL 356 06		UL 356 08
	droite		droite



PINCES HEMOSTATQUES

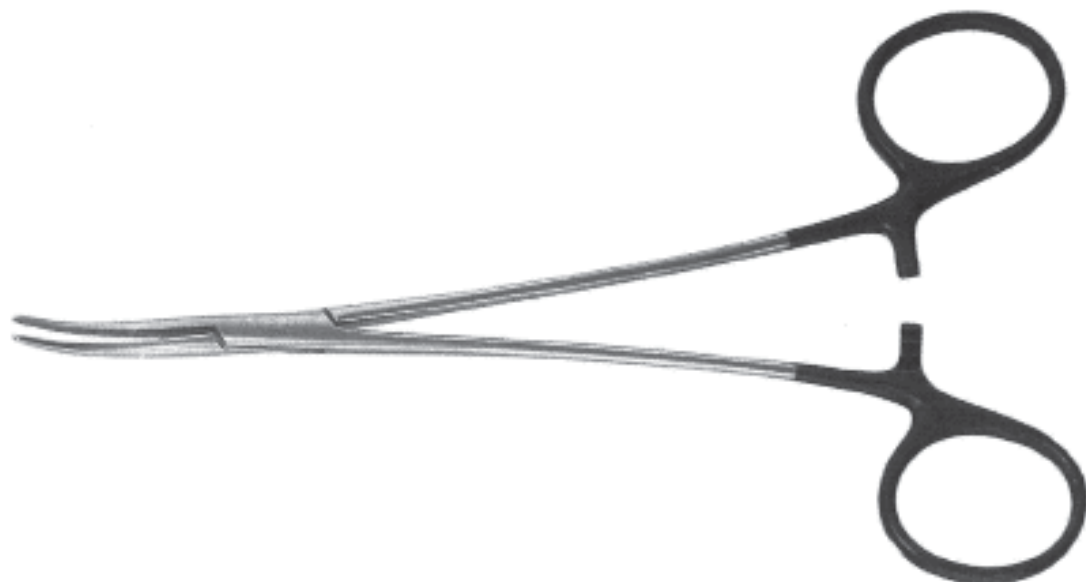

LERICHE - 180 mm **UP-LINE**

1/1 à griffes



1/1 sans griffes

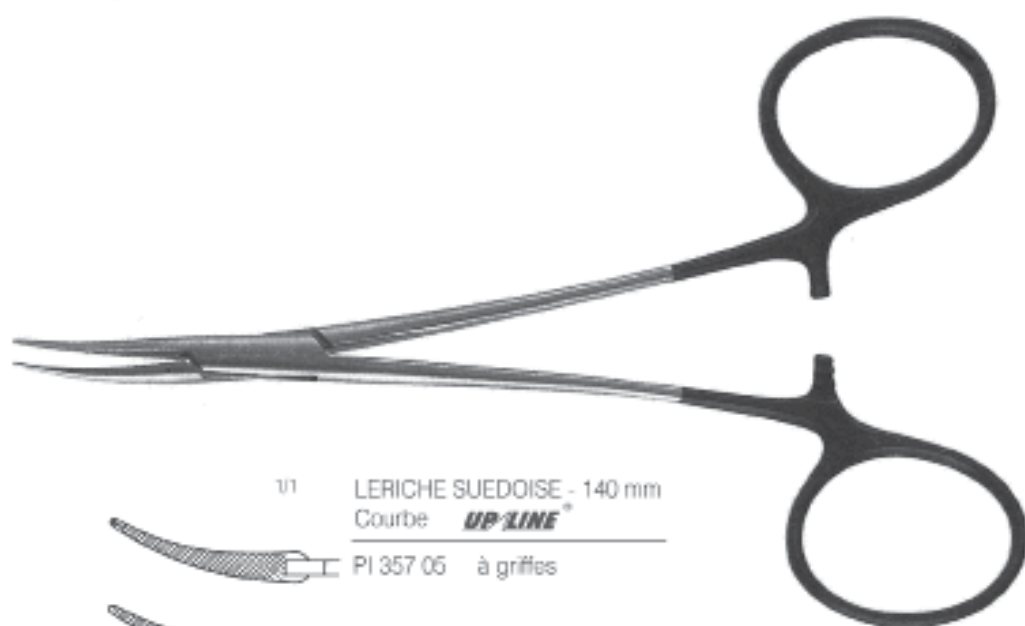

1/1 LERICHE SUEDOISE - 140 mm
Courbe **UP-LINE**





PINCES HEMOSTATIQUES

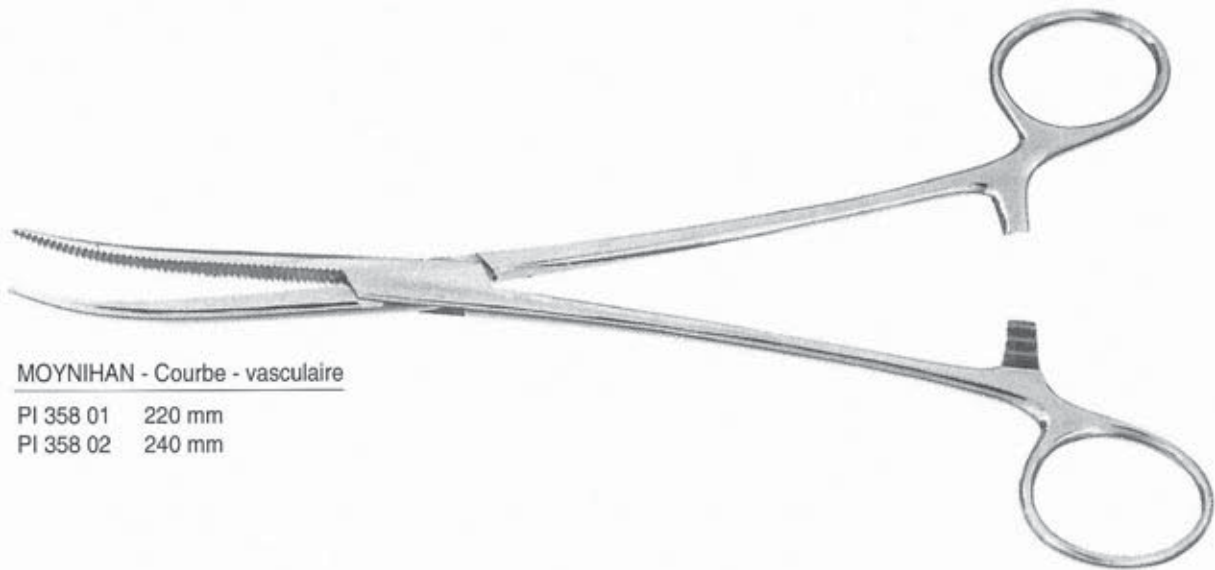

MOYNIHAN - Courbe - vasculaire

- PI 358 01 220 mm
- PI 358 02 240 mm

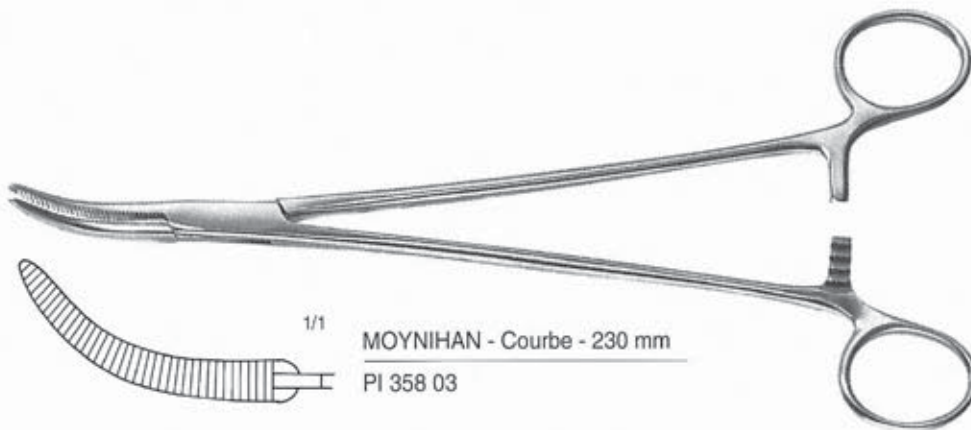

1/1

MOYNIHAN - Courbe - 230 mm
PI 358 03

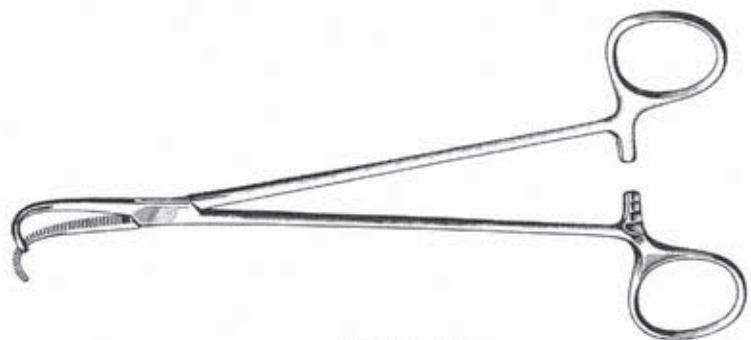

1/1

NEGUS - 200 mm

PI 358 04 grande courbure



PI 358 05 petite courbure



PINCES HEMOSTATIQUES

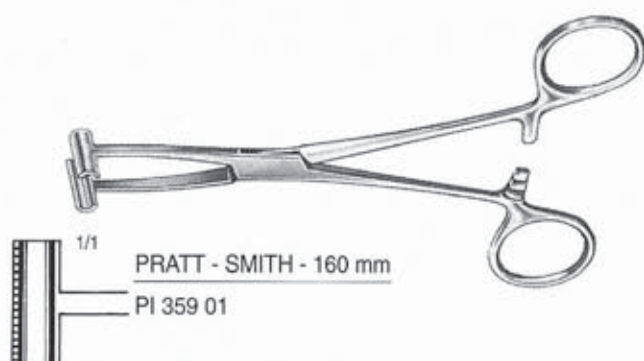

1/1
PRATT - SMITH - 160 mm
PI 359 01



1/1 PROVIDENCE HOSPITAL - 140 mm
PI 359 02 courbe
PI 359 03 droite

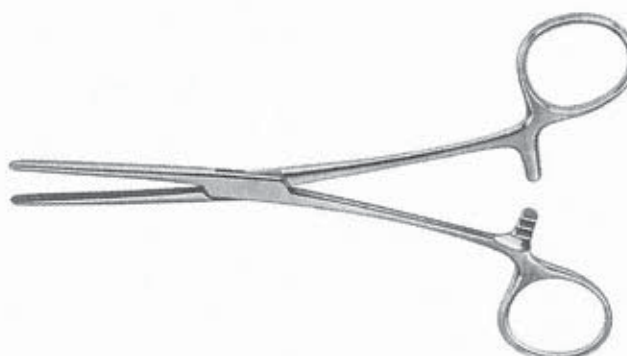

ROCHESTER CARMALT



160 mm

PI 359 04 courbe
PI 359 05 droite



200 mm

PI 359 06 courbe
PI 359 07 droite



PINCES HEMOSTATQUES

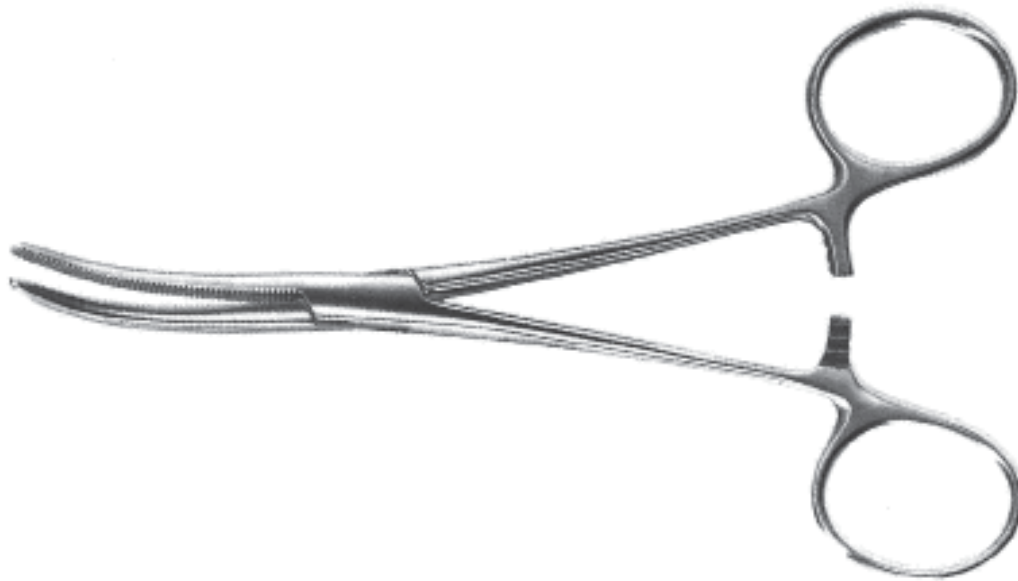

ROCHESTER PEAN MODELE FRANÇAIS

droite

courbe



PI 360 01

160 mm



PI 360 02



PI 360 03

180 mm



PI 360 04



PI 360 05

200 mm



PI 360 06



PI 360 07

240 mm



PI 360 08

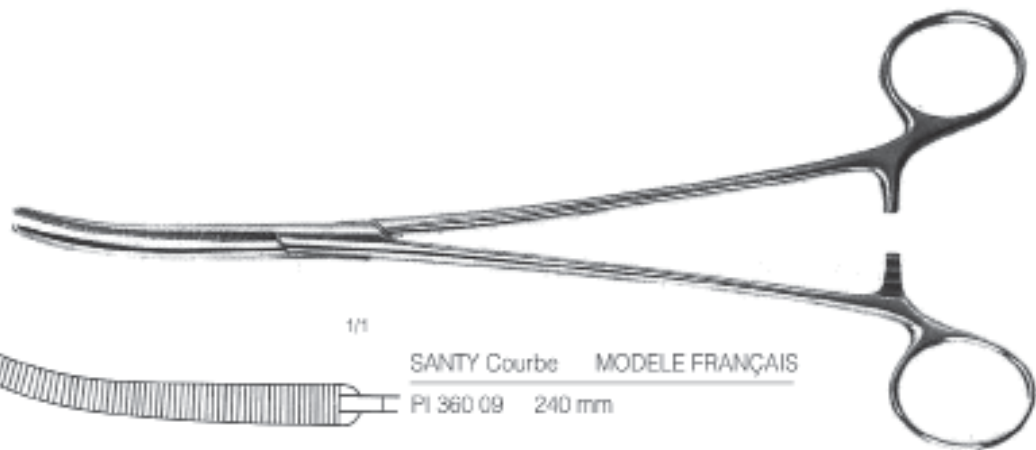

1/1

SANTY Courbe MODELE FRANÇAIS



PI 360 09 240 mm



PI 360 10 300 mm



PINCES HEMOSTATIQUES

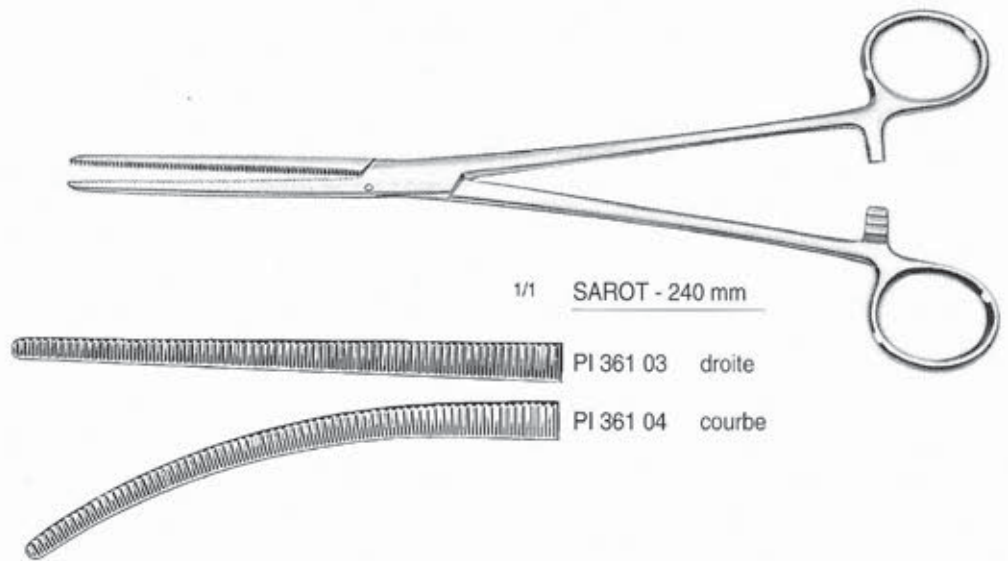
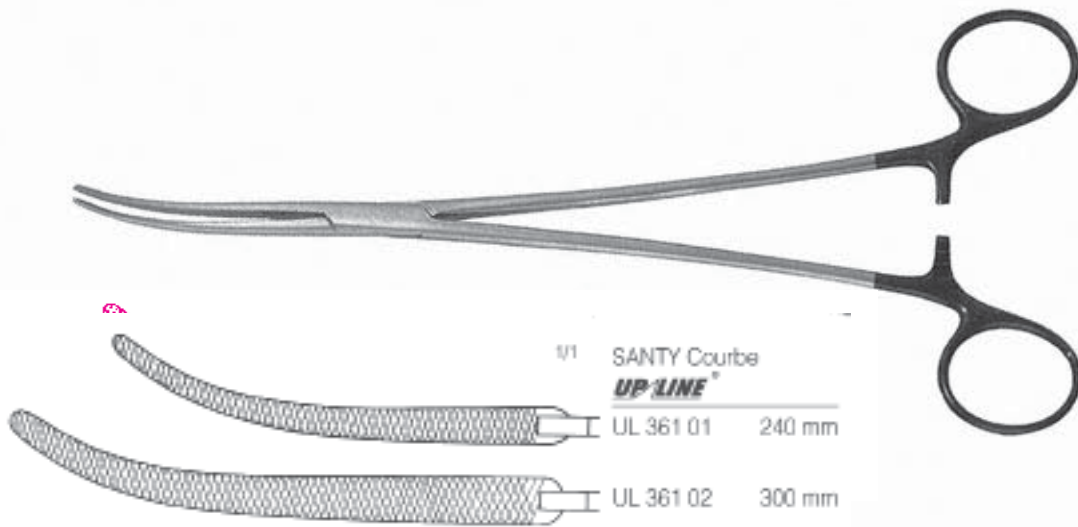

SPENCER WELLS



droite

PI 361 05	130 mm
PI 361 06	150 mm



courbe

PI 361 07	130 mm
PI 361 08	150 mm

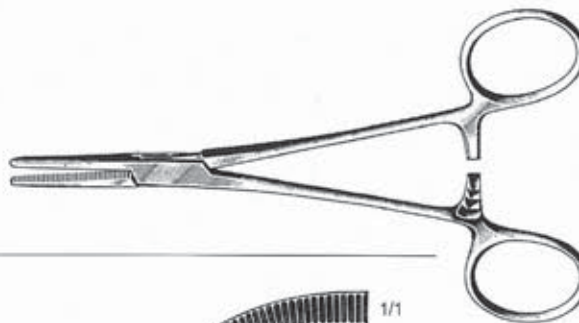



PINCES HEMOSTATIQUES

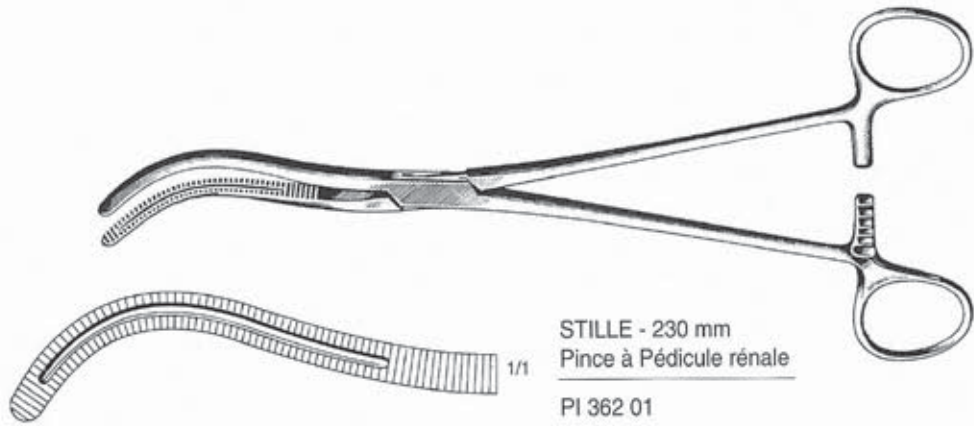



PINCES MENISQUES

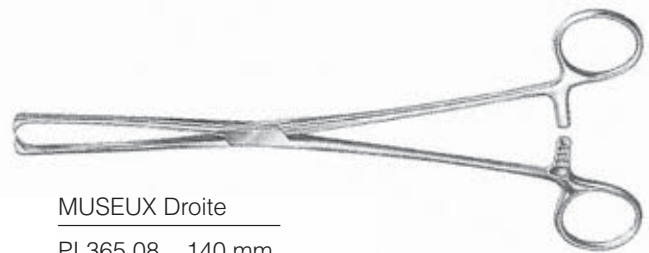
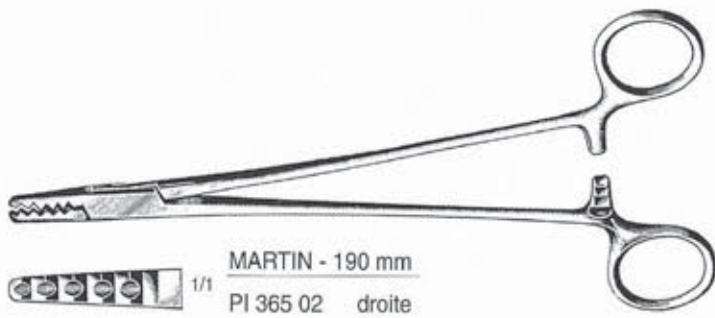
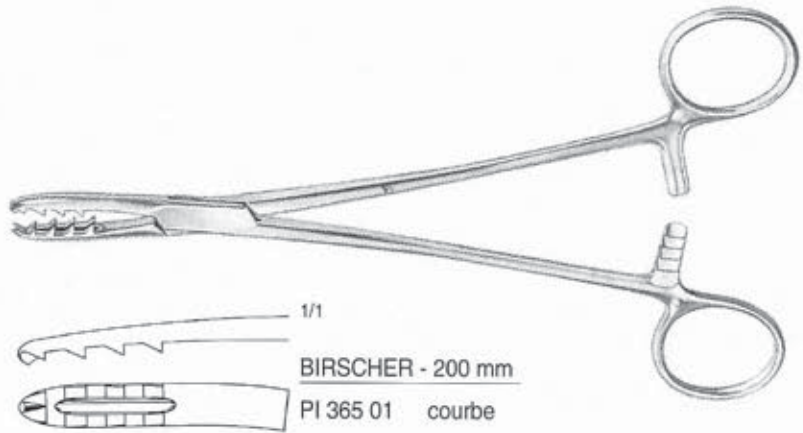

MUSEUX Droite

- PI 365 08 140 mm
- PI 365 03 180 mm
- PI 365 04 200 mm



PI 366 01 100 mm
PI 366 02 120 mm
PI 366 03 140 mm
PI 366 04 150 mm



MORS OBLIQUES

PI 366 05 140 mm



ONGLES INCARNES

PI 366 06 120 mm
PI 366 07 130 mm
PI 366 08 150 mm



SECATEUR

PI 366 09 130 mm

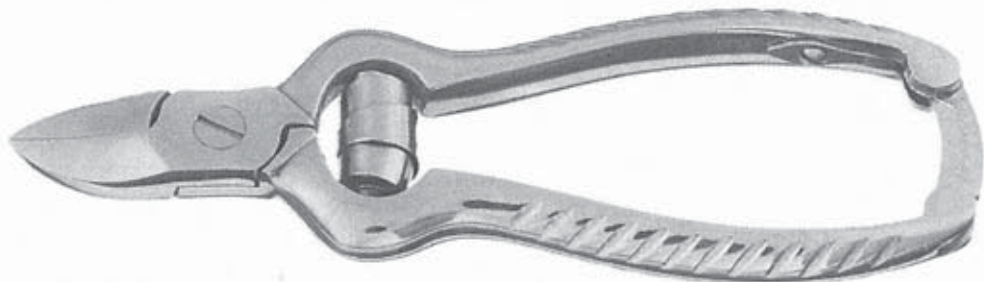





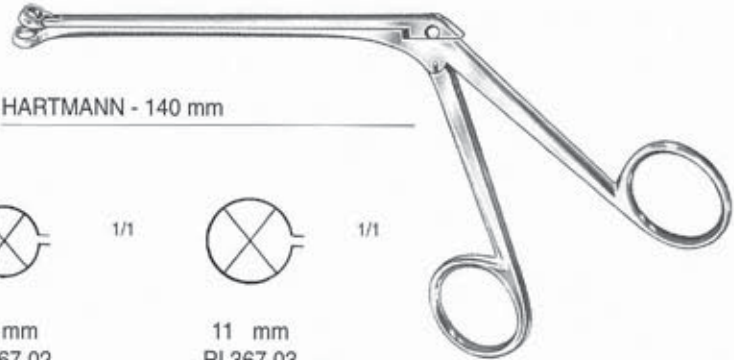

PINCES ORL - AMYGDALES

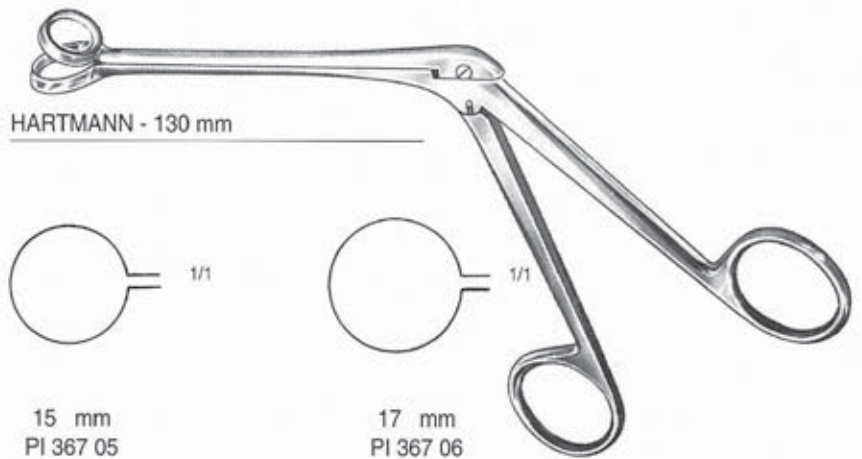

-  1/1
6 mm
PI 367 01
-  1/1
9 mm
PI 367 02
-  1/1
11 mm
PI 367 03



-  1/1
13 mm
PI 367 04
-  1/1
15 mm
PI 367 05
-  1/1
17 mm
PI 367 06

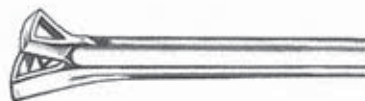

SCHMEDEN - 140 mm

-  1/1
5 mm
PI 367 07
-  1/1
7 mm
PI 367 08
-  1/1
9 mm
PI 367 09



PINCES ORL - LARYNGOLOGIE

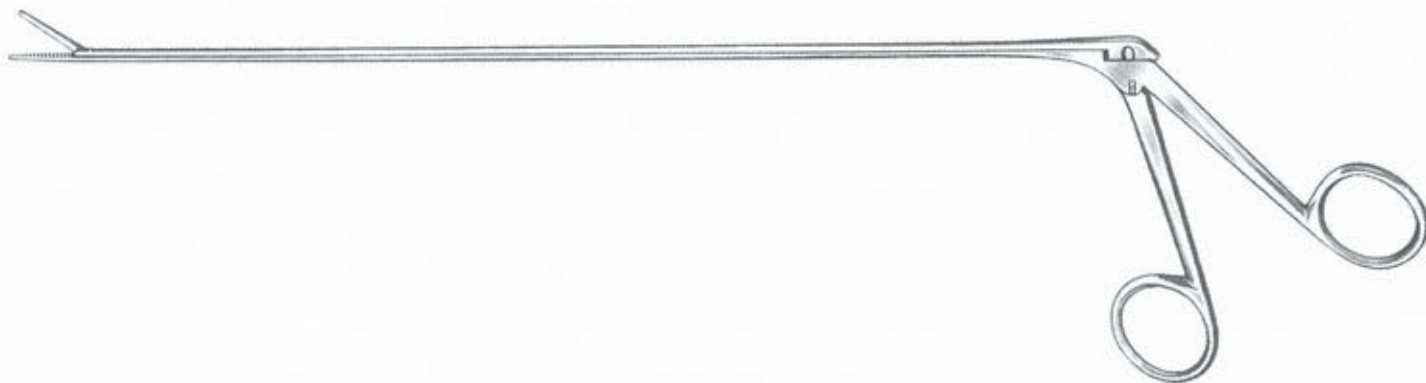

CHEVALIER JACKSON

1 mors mobile	longueur de tige			
	300 mm	400 mm	500 mm	600 mm
	PI 368 01	PI 368 02	PI 368 03	PI 368 04
	PI 368 05	PI 368 06	PI 368 07	PI 368 08
	PI 368 09	PI 368 10	PI 368 11	PI 368 12
	PI 368 13	PI 368 14	PI 368 15	PI 368 16
	PI 368 17	PI 368 18	PI 368 19	PI 368 20
	PI 368 21	PI 368 22	PI 368 23	PI 368 24
	ø 2 mm PI 368 25	PI 368 26	PI 368 27	PI 368 28
	PI 368 29	PI 368 30	PI 368 31	PI 368 32
	ø 2 mm ø 4 mm PI 368 33	PI 368 34	PI 368 35	PI 368 36



PINCES ORL - LARYNGOLOGIE

CHEVALIER JACKSON

2 mors mobiles

longueur de tige

300 mm

400 mm

500 mm

600 mm



PI 369 01

PI 369 02

PI 369 03

PI 369 04



PI 369 05

PI 369 06

PI 369 07

PI 369 08



ø 2 mm

PI 369 09

PI 369 10

PI 369 11

PI 369 12

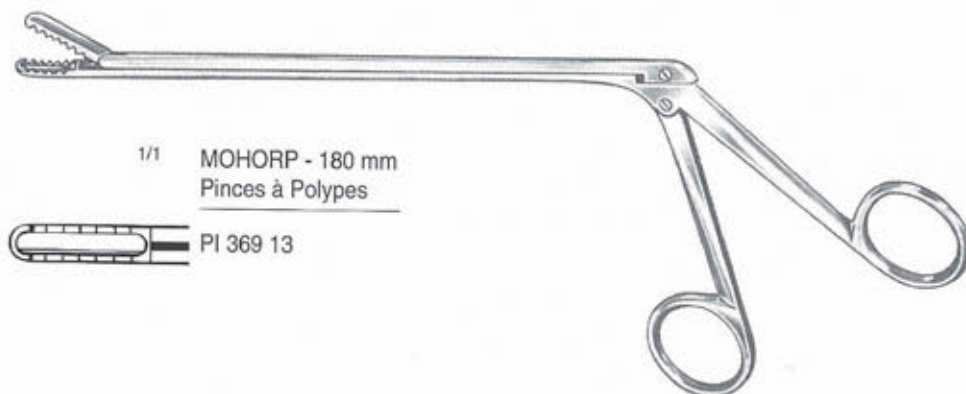

1/1 MOHORP - 180 mm
Pinces à Polypes

PI 369 13



CORPS ETRANGERS

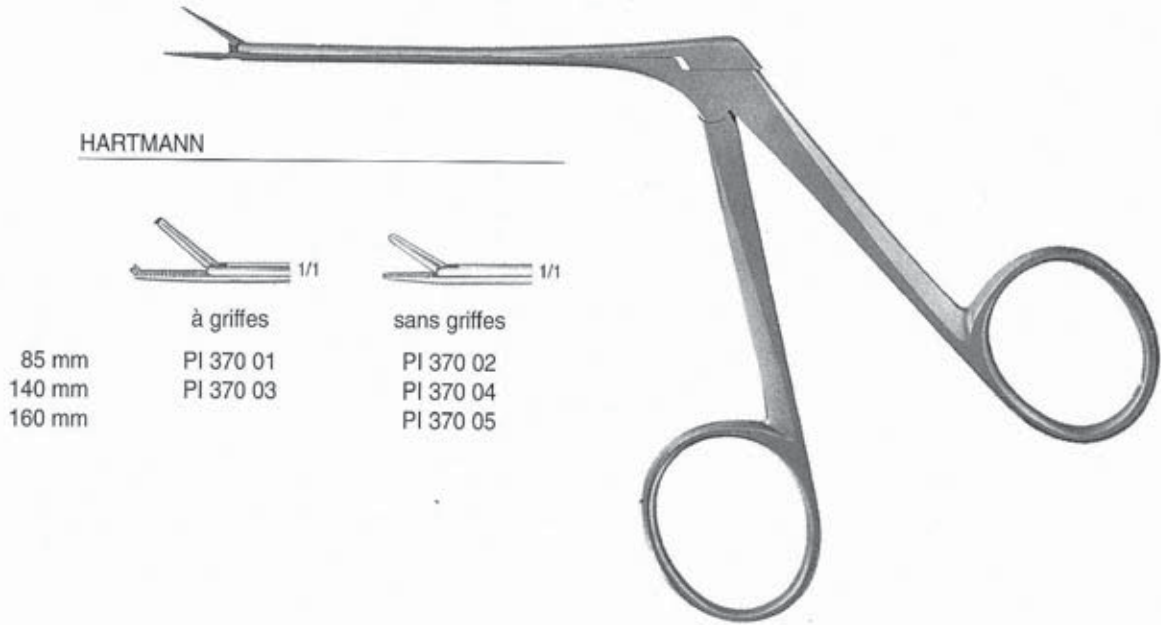

PANSEMENTS

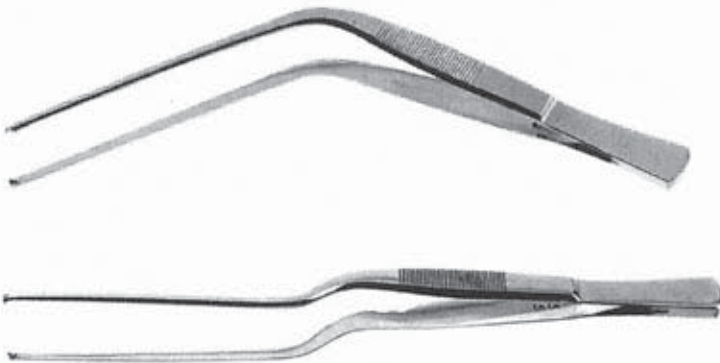

130 mm

PI 370 06 mors à griffes
 PI 370 09 mors striés

LUCAE - 150 mm

PI 370 10 mors à griffes
 PI 370 13 mors striés



POLITZER - 140 mm

1/1



mors a griffes
 PI 370 14



mors striés
 PI 370 16



PINCES ORL - RHINOLOGIE

BRUNINGS - 190 mm



5 mm
PI 371 01



6 mm
PI 371 02



8 mm
PI 371 03

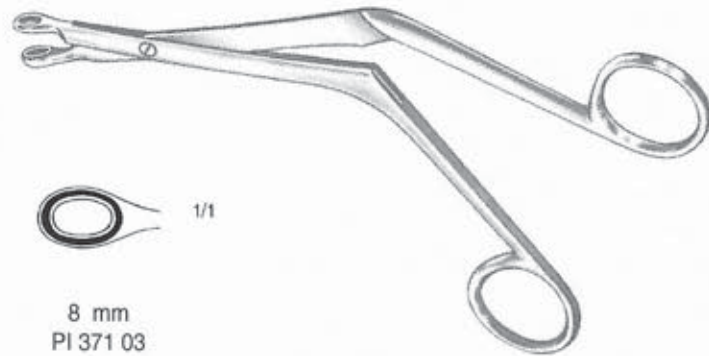

HARTMANN - 125 mm



5 mm
PI 371 04



7 mm
PI 371 05



9 mm
PI 371 06



11 mm
PI 371 07

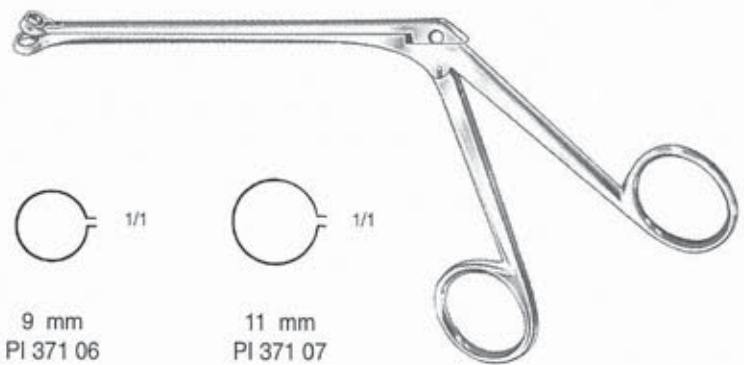

HARTMANN GRUNWALD - 125 mm



2 mm
PI 371 08



3 mm
PI 371 09



5 mm
PI 371 10



HARTMANN MYLES - 125 mm



2 mm
PI 371 11



2,5 mm
PI 371 12



3 mm
PI 371 13



3,5 mm
PI 371 14



HARTMANN STRUYKEN - 125 mm



1 mm
PI 371 15



2 mm
PI 371 16





PINCES ORL - RHINOLOGIE

MIDDLETON JANSEN - 180 mm

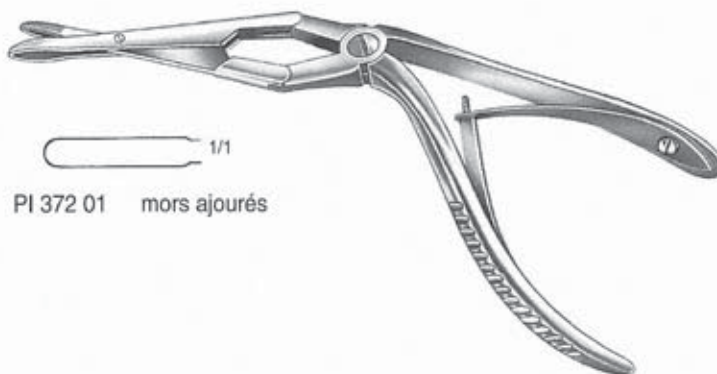

PI 372 01 mors ajourés

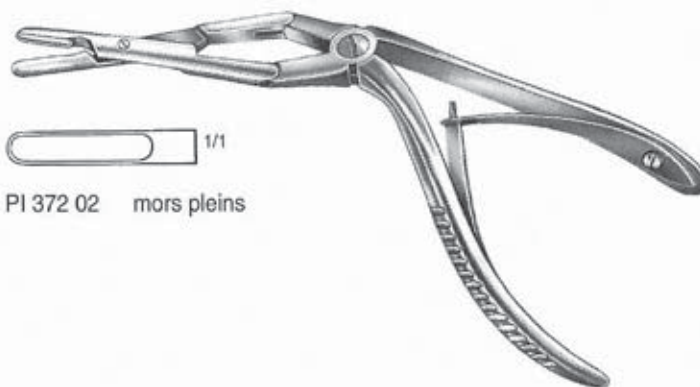

PI 372 02 mors pleins

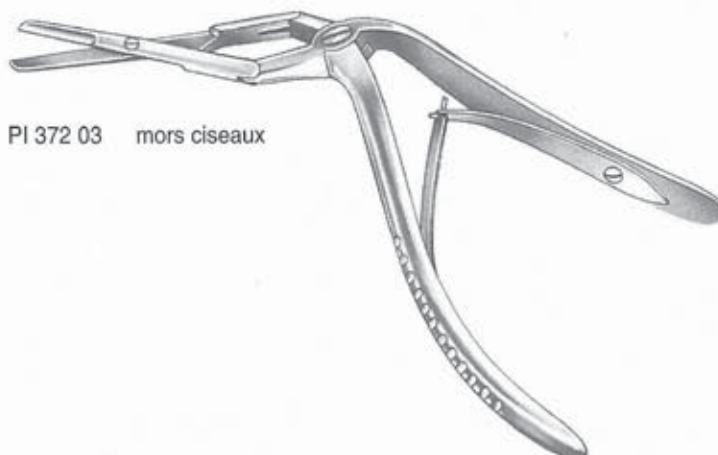

PI 372 03 mors ciseaux



PINCES ORL - RHINOLOGIE

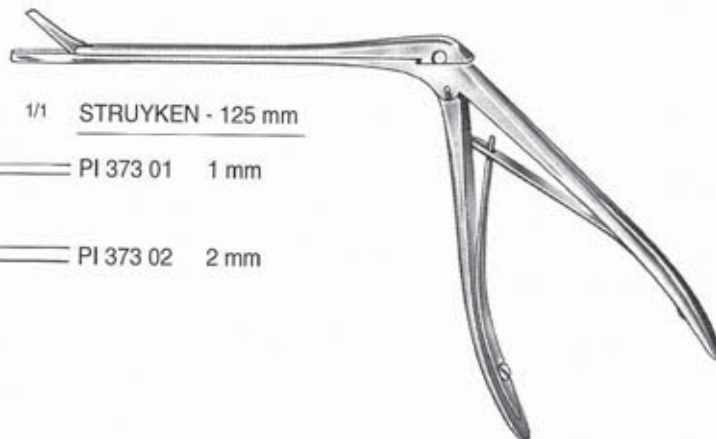

1/1 STRUYKEN - 125 mm

PI 373 01 1 mm

PI 373 02 2 mm

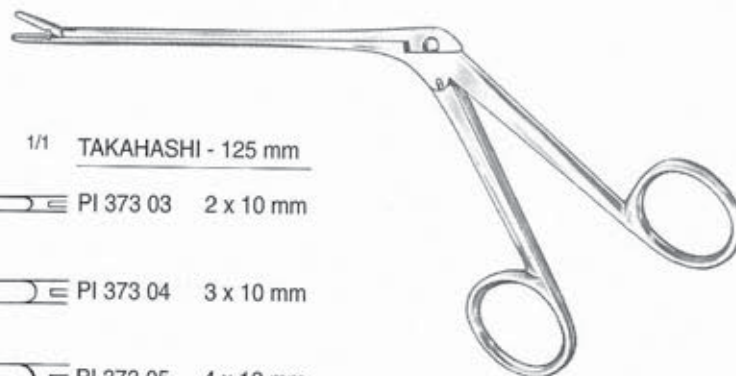

1/1 TAKAHASHI - 125 mm

PI 373 03 2 x 10 mm

PI 373 04 3 x 10 mm

PI 373 05 4 x 10 mm

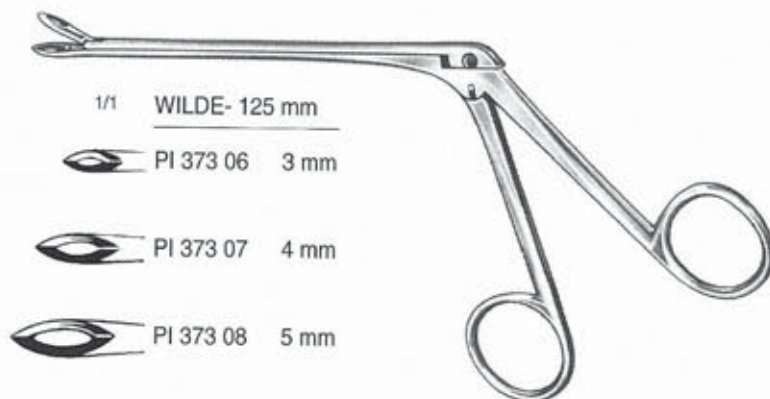

1/1 WILDE- 125 mm

PI 373 06 3 mm

PI 373 07 4 mm

PI 373 08 5 mm



PINCES PANSEMENTS

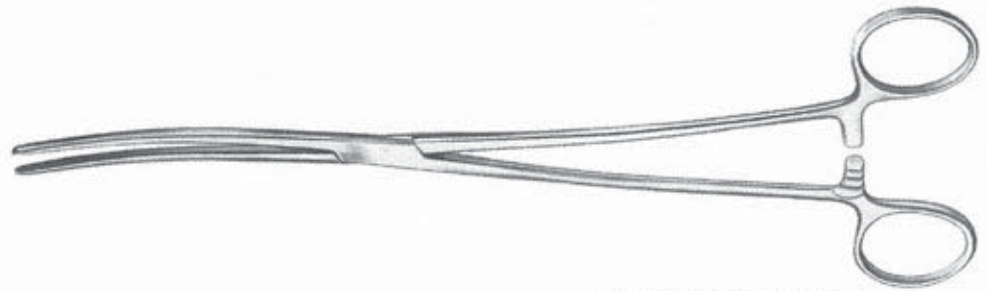

1/1 BOZEMANN - 275 mm

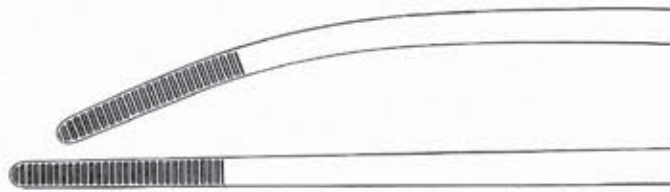

PI 376 01 courbe

PI 376 02 droite

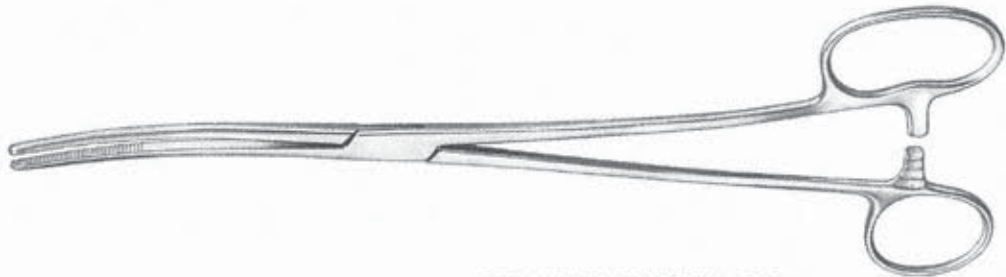

1/1 BOZEMANN DOUGLAS - 260 mm



PI 376 03 courbe

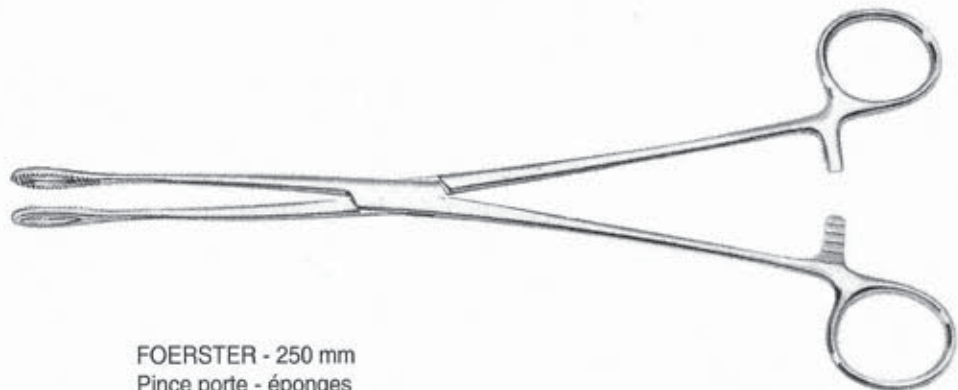

FOERSTER - 250 mm
Pince porte - éponges

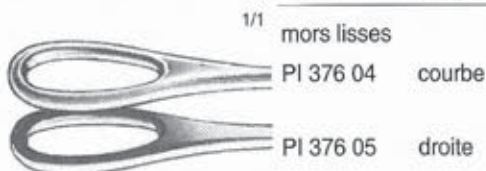

1/1 mors lisses

PI 376 04 courbe

PI 376 05 droite

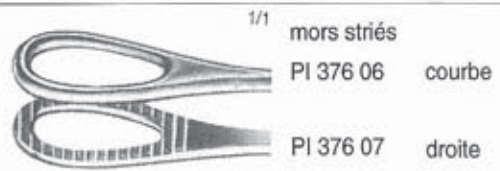

1/1 mors striés

PI 376 06 courbe

PI 376 07 droite



PINCES PANSEMENTS

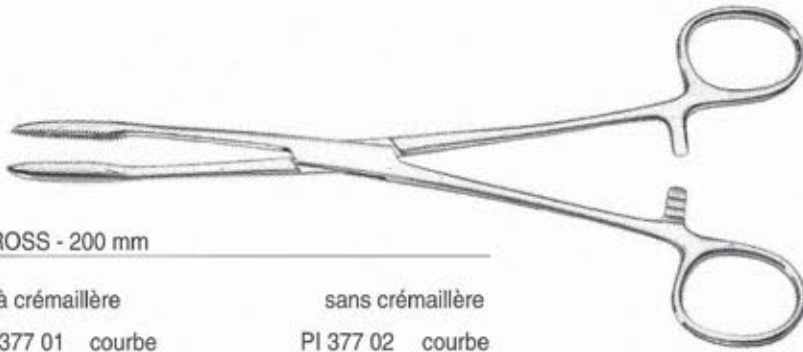

GROSS - 200 mm

à crémaillère

PI 377 01 courbe
PI 377 03 droite

sans crémaillère

PI 377 02 courbe
PI 377 04 droite

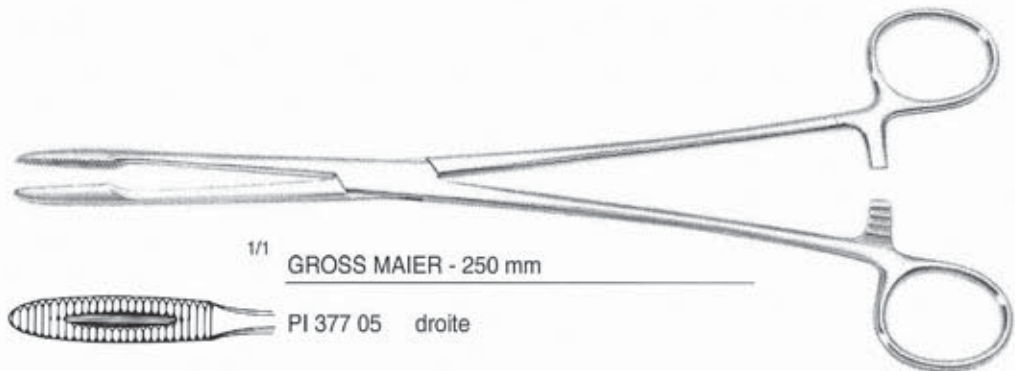

^{1/1} GROSS MAIER - 250 mm

PI 377 05 droite

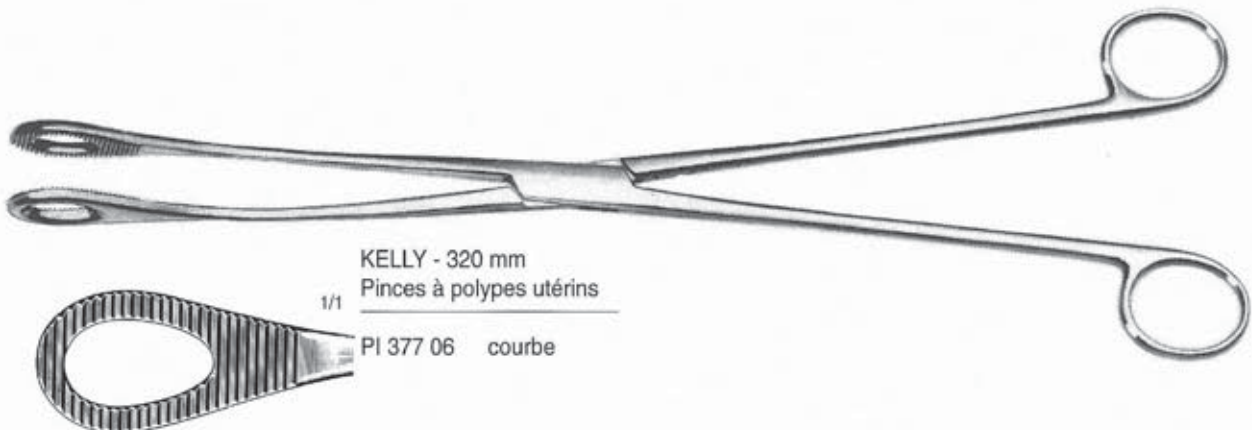

KELLY - 320 mm
Pinces à polypes utérins

^{1/1} PI 377 06 courbe



PINCES PANSEMENTS

LONGUETTE - Droite

PI 378 01 240 mm

PI 378 02 300 mm



LONGUETTE - 240 mm

PI 378 03 courbe

LONGUETTE COUDEE CHERON - 240 mm

PI 378 04





PINCES PANSEMENTS

LONGUETTE
DEMONTABLE (à doigt) - 240 mm

PI 379 01 droite

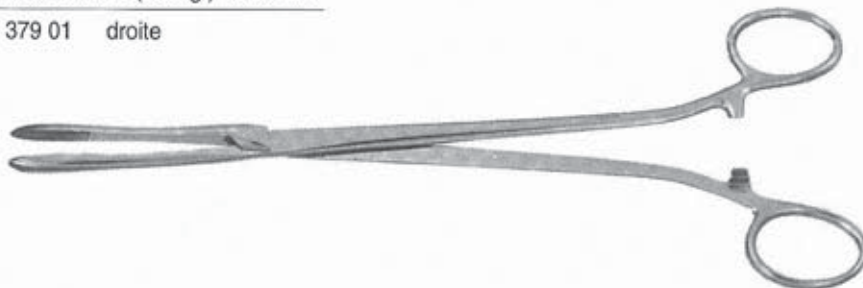

LONGUETTE COUDEE CHERON
DEMONTABLE (à doigt) - 240 mm

PI 379 02 droite

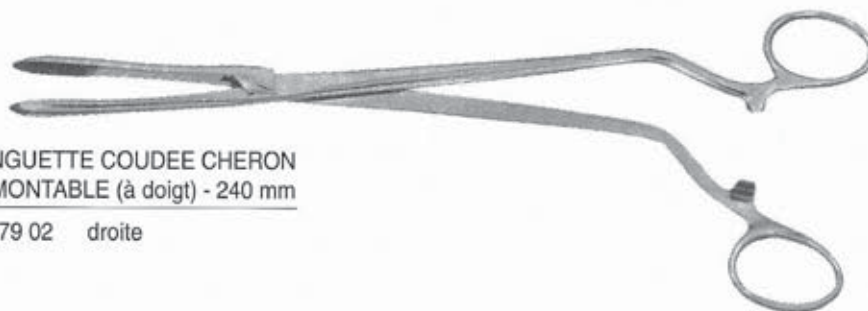

PEAN - Droite

PI 379 03 140 mm

PI 379 04 160 mm

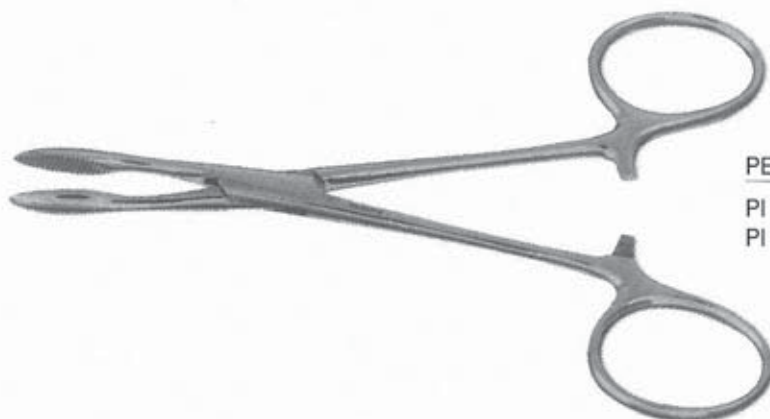

PEAN
DEMONTABLE (à doigt) - 140 mm

PI 379 05 droite





PINCES PANSEMENTS

PANSEMENTS USAGES - 550 mm
PI 380 01



PELKMANN - 260 mm
PI 380 02 droite

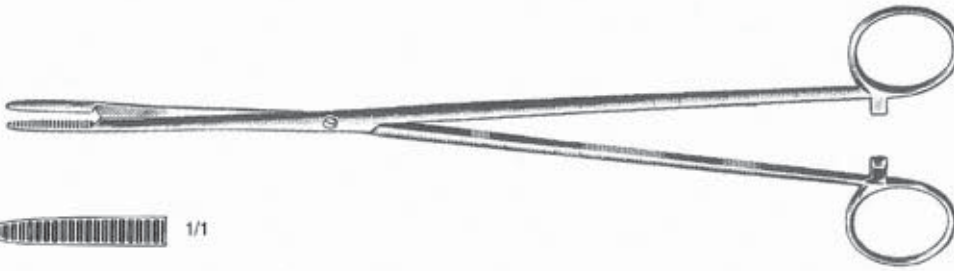

ULRICH - 270 mm
PI 380 03 courbe
PI 380 04 droite

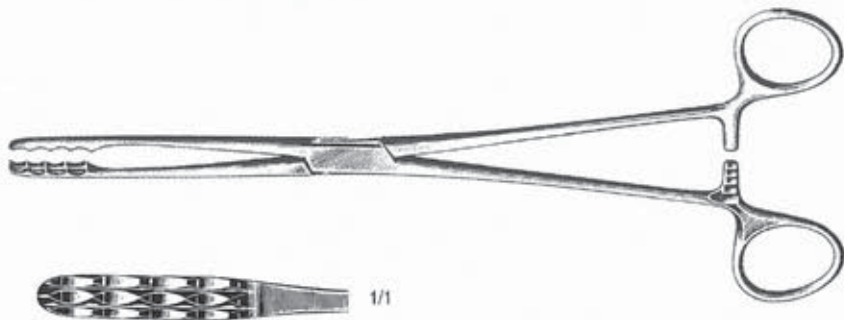



PINCES PLATRE

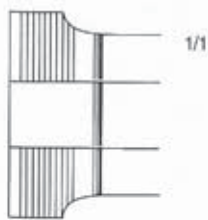

1/1

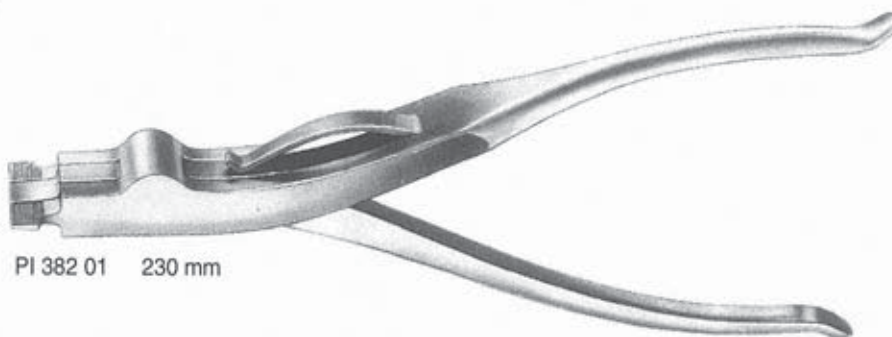

PI 382 01 230 mm



HENNING - 280 mm

PI 382 02
mors 54 mm

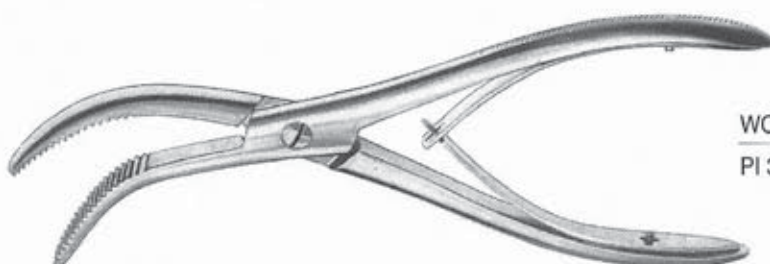

WOLF - 240 mm

PI 382 03



PINCES PREHENSION AJOUREES

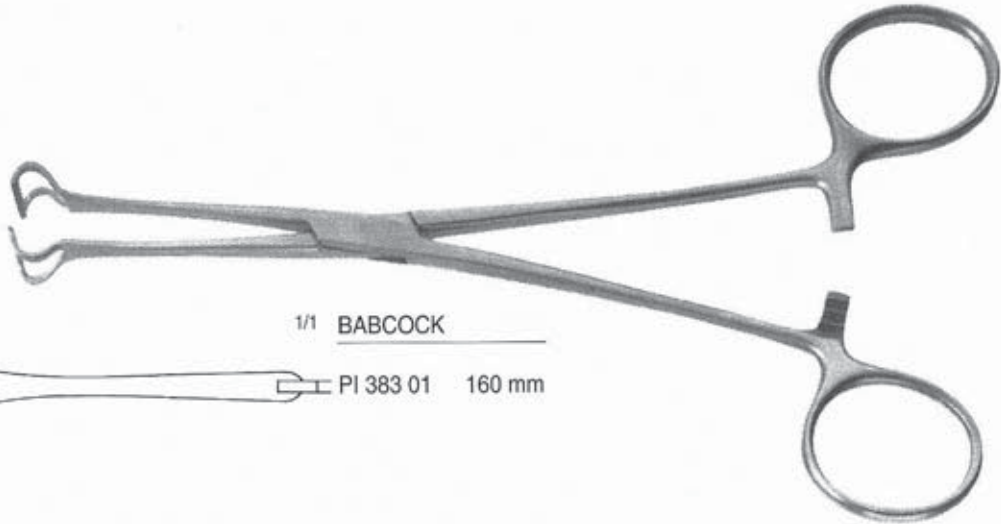

1/1 BABCOCK

PI 383 01 160 mm

PI 383 02 200 mm
PI 383 03 230 mm

1/1 ATRAUMATIQUE

PI 383 04 210 mm

1/1 TUNGSTENE

PI 383 05 160 mm

PI 383 06 200 mm
PI 383 07 240 mm



PINCES PREHENSION AJOUREES

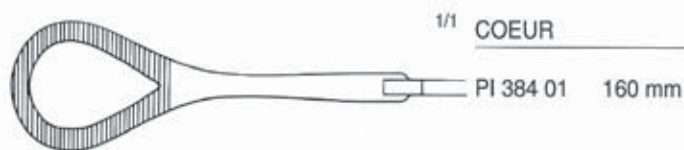
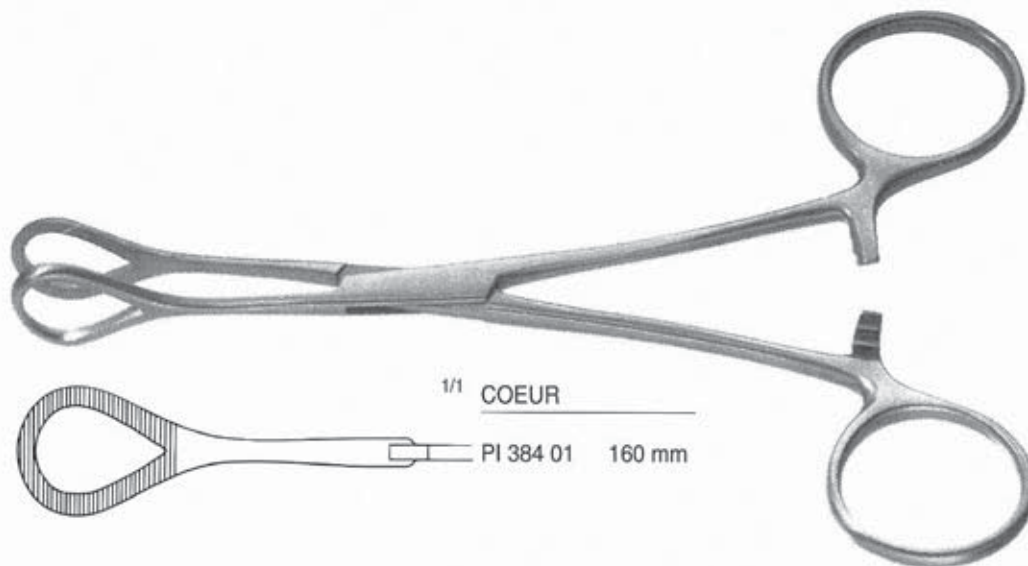

1/1 COEUR

PI 384 01 160 mm

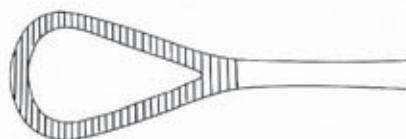

PI 384 02 180 mm

PI 384 03 200 mm

PI 384 04 220 mm

COEUR - ATRAUMATIQUE

PI 384 05 250 mm

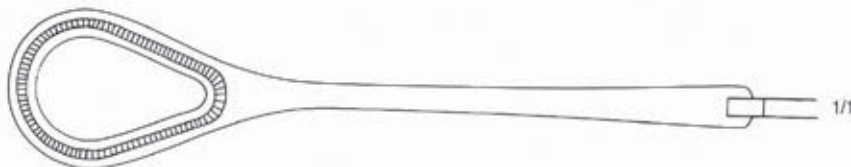
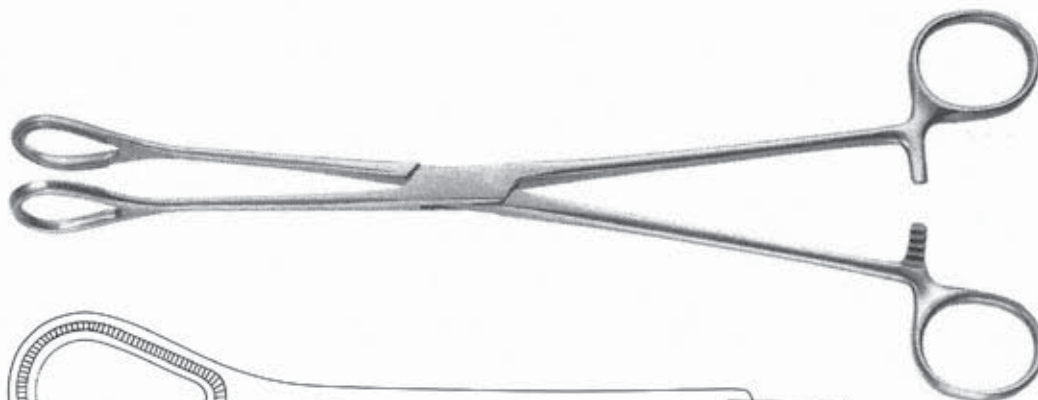

1/1



PINCES PREHENSION AJOUREES

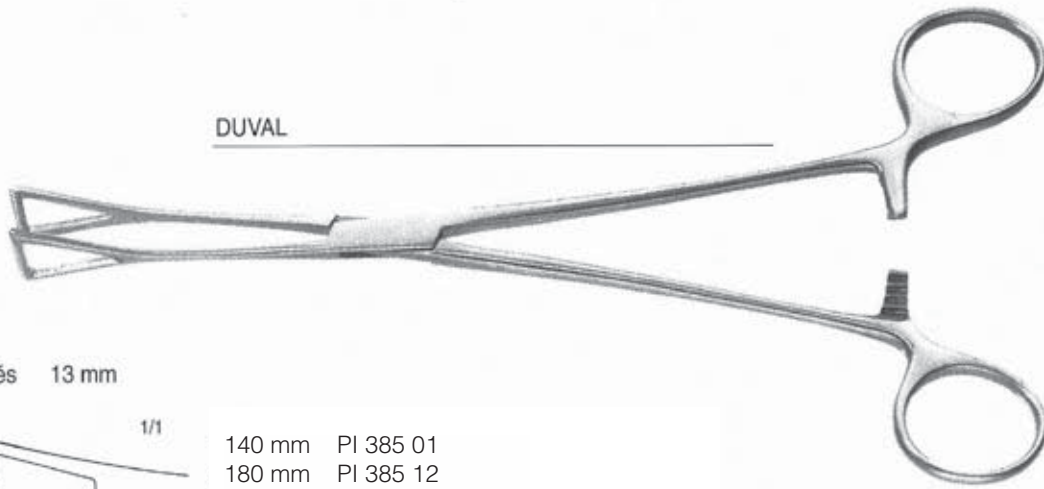

DUVAL

mors dentés 13 mm

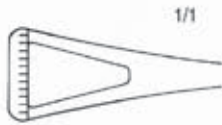

- 140 mm PI 385 01
- 180 mm PI 385 12
- 200 mm PI 385 02
- 220 mm PI 385 03

mors striés

13 mm

18 mm

24 mm

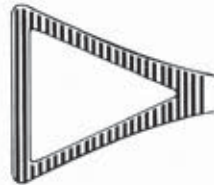

200 mm
220 mm

PI 385 05
PI 385 08

PI 385 06
PI 385 09

PI 385 07

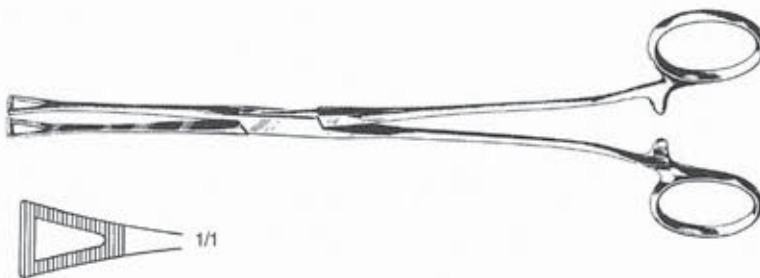

DUVAL 200 mm

PI 385 11 mors striés 8 mm

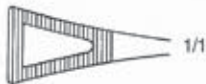



PINCES PREHENSION AJOUREES

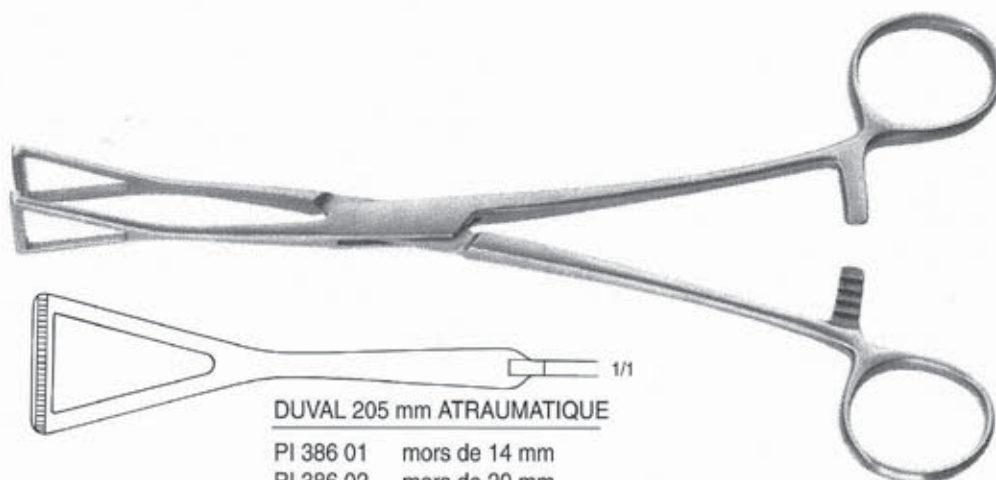

DUVAL 205 mm ATRAUMATIQUE

PI 386 01 mors de 14 mm

PI 386 02 mors de 20 mm

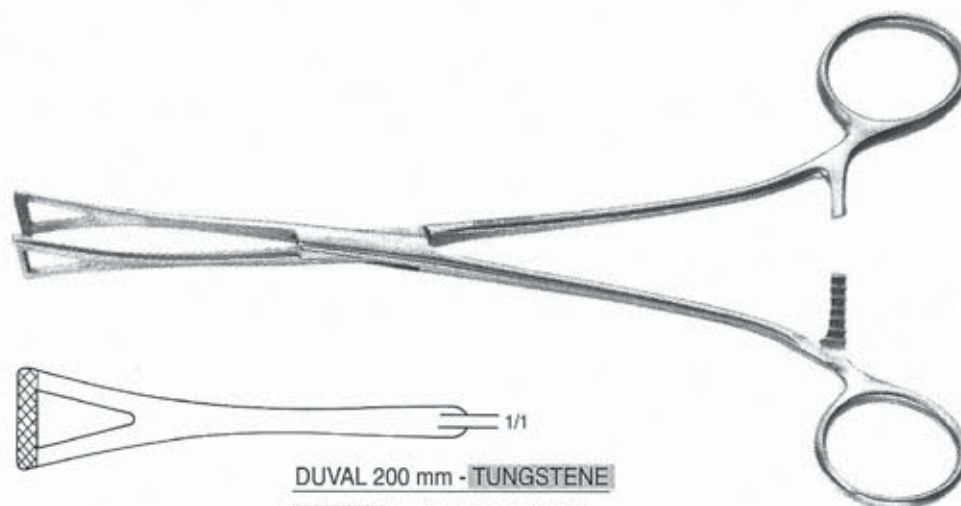

DUVAL 200 mm - TUNGSTENE

PI 386.03 mors de 13 mm

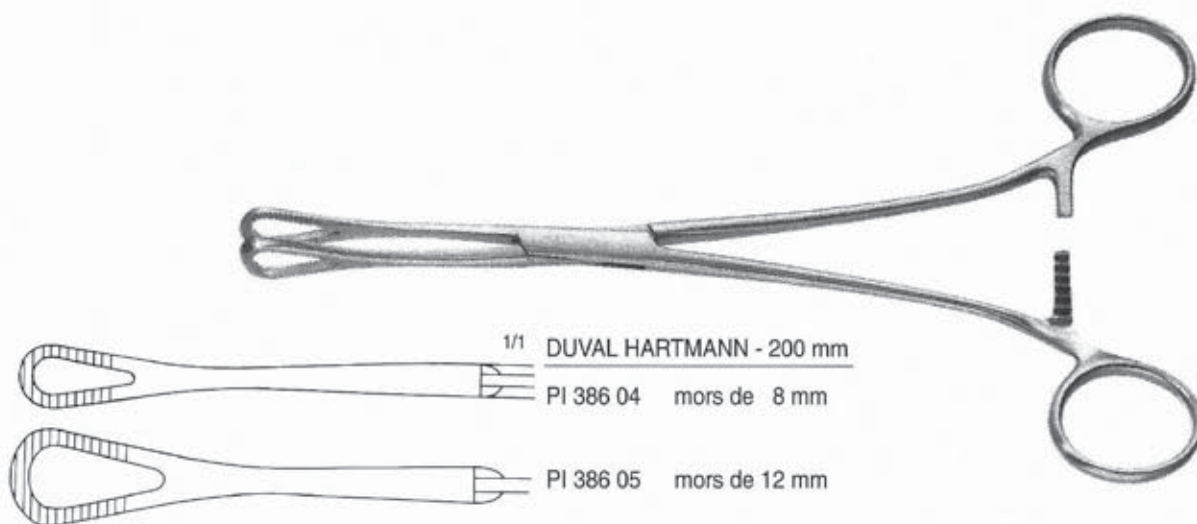

1/1 DUVAL HARTMANN - 200 mm

PI 386 04 mors de 8 mm

PI 386 05 mors de 12 mm



PINCES PREHENSION AJOUREES

DUVAL WALTER - 200 mm
PI 387 01 mors de 12 mm

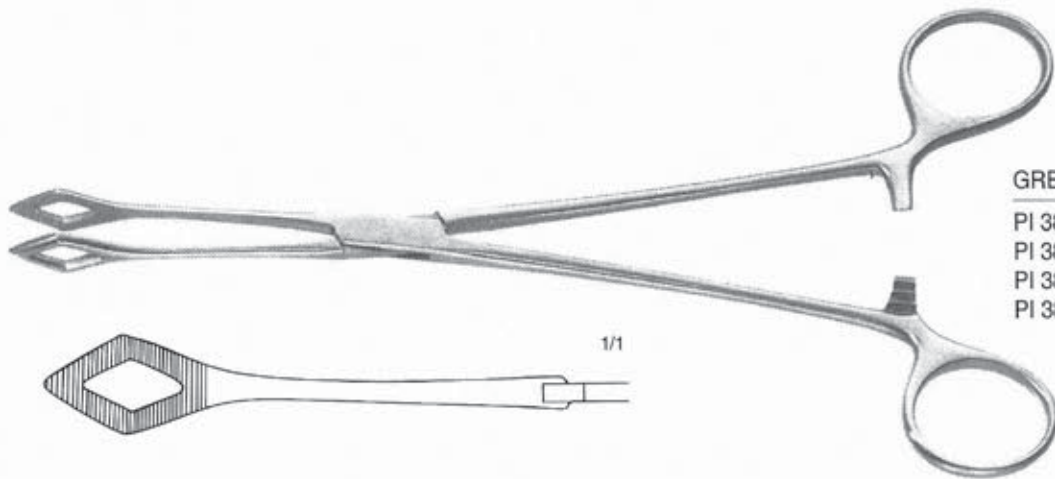
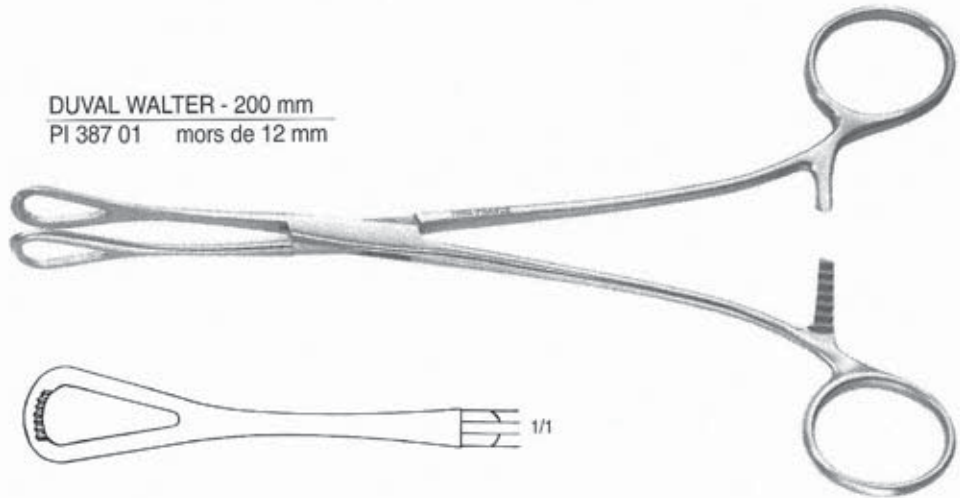

GREGOIRE

- | | |
|-----------|--------|
| PI 387 02 | 160 mm |
| PI 387 03 | 180 mm |
| PI 387 04 | 200 mm |
| PI 387 05 | 220 mm |

HALLMANN - 360 mm

PI 387 06 pince à tunneliser

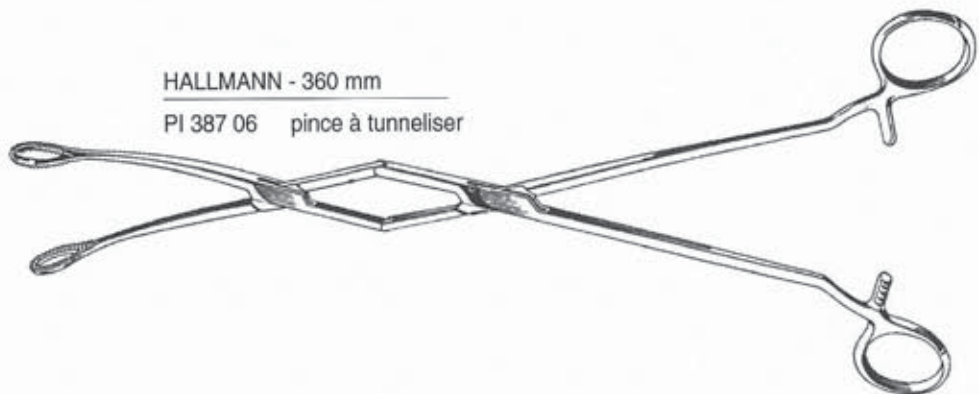

WILLIAMS - 160 mm

PI 387 07

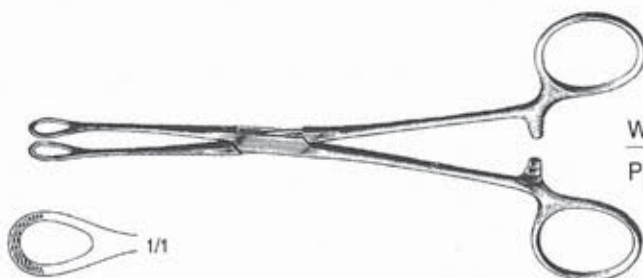



PINCES PREHENSION MULTIGRIFFES

ALLIS

4 x 5 griffes

5 x 6 griffes



1/1



PI 389 01 150 mm

PI 389 02 150 mm

PI 389 03 190 mm

PI 389 04 210 mm

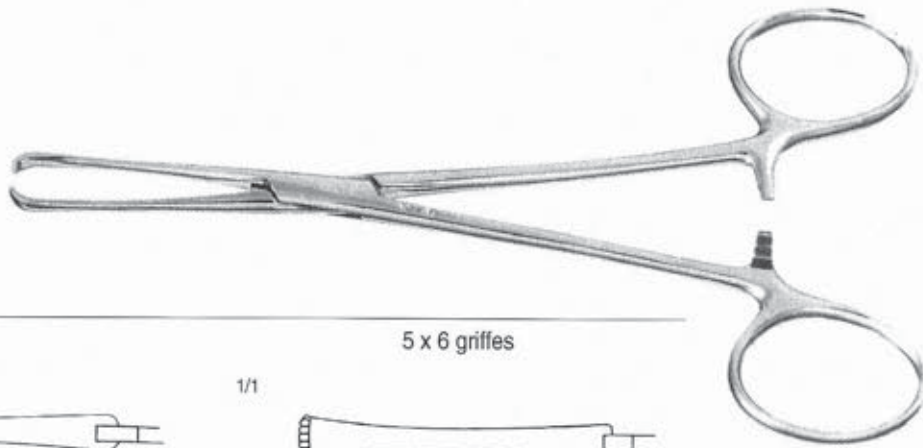

ALLIS - ATRAUMATIQUE

PI 389 05 160 mm

PI 389 06 190 mm

PI 389 07 250 mm

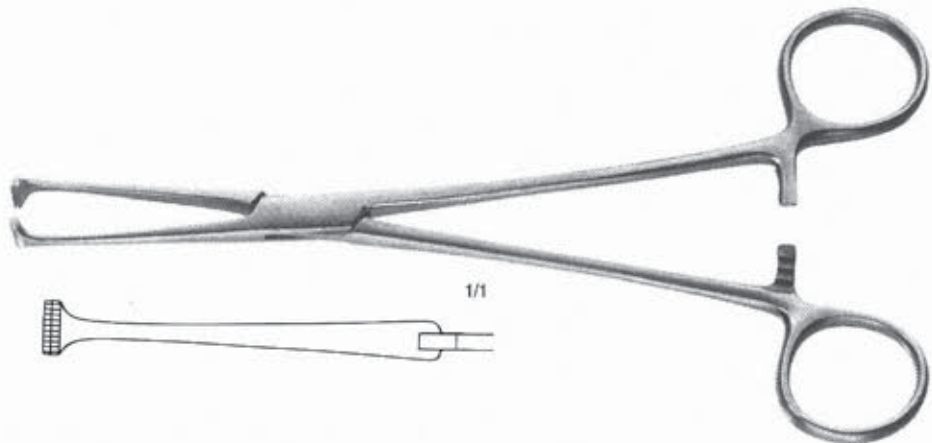

1/1

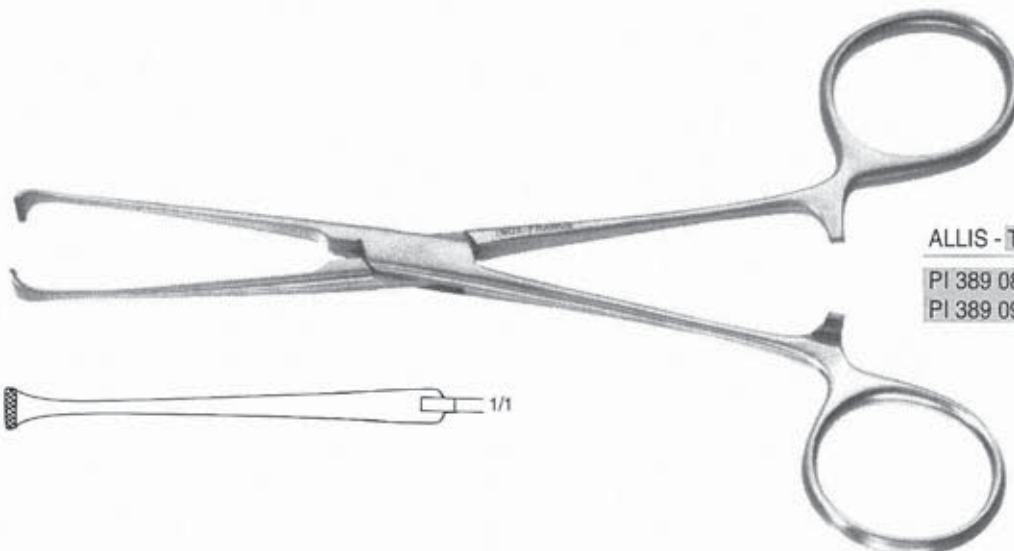

ALLIS - TUNGSTENE

PI 389 08 150 mm

PI 389 09 200 mm



1/1



PINCES PREHENSION MULTIGRIFFES

CHAPUT 2 x 3 griffes

PI 390 01 130 mm
PI 390 02 160 mm

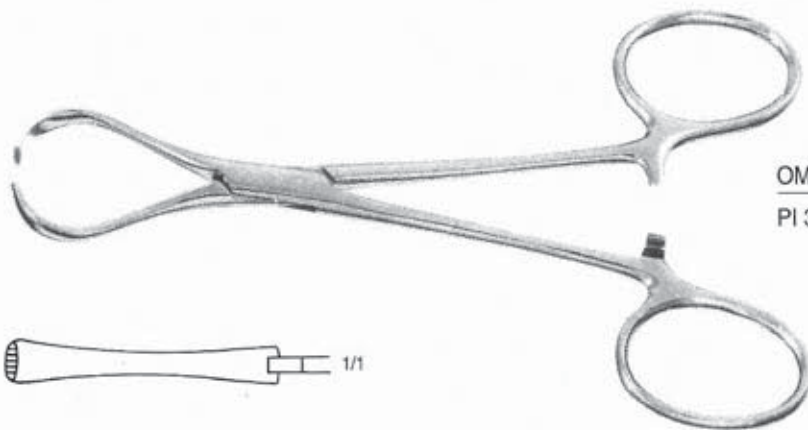
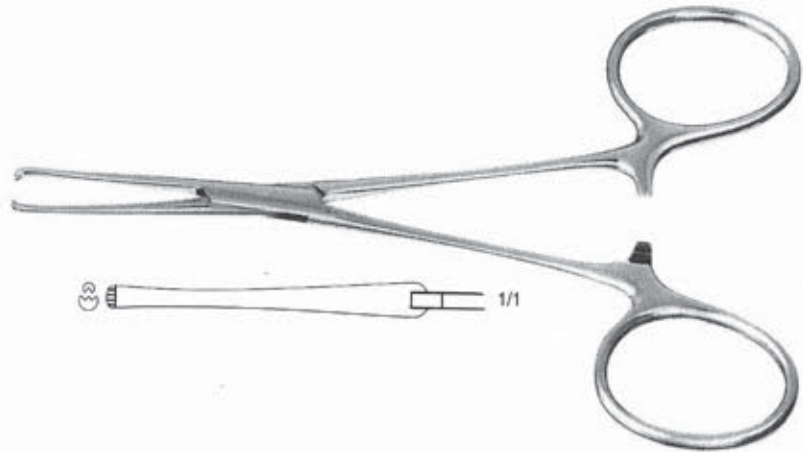

OMBREDANNE 6 x 7 griffes

PI 390 03 130 mm

TUFFIER 4 x 5 griffes

PI 390 04 130 mm

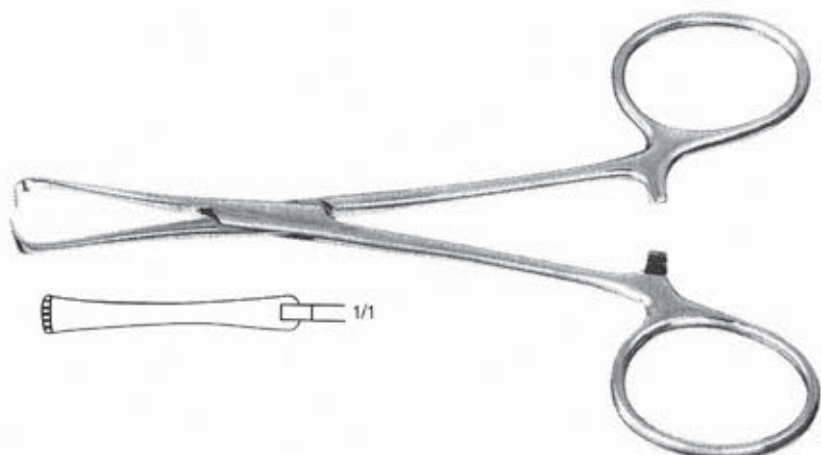



PINCES PRESSE TUBES

HOFFMANN

PI 392 01	17 mm
PI 392 02	20 mm
PI 392 03	25 mm
PI 392 04	30 mm
PI 392 05	40 mm

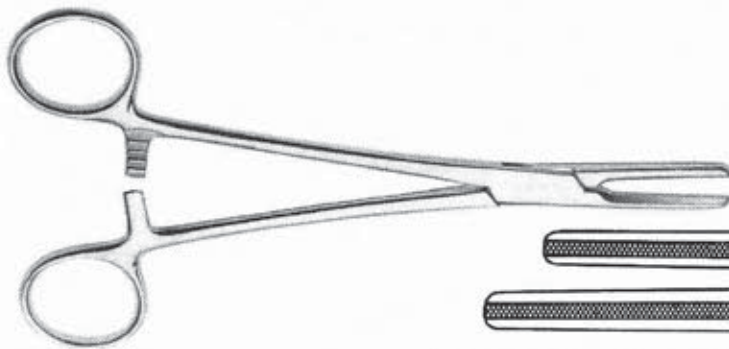
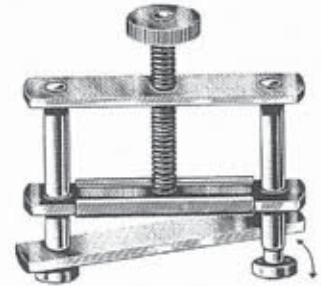

1/1 MURPHY

	PI 392 07	150 mm
	PI 392 08	180 mm
	PI 392 09	200 mm
	PI 392 10	160 mm mors lisses

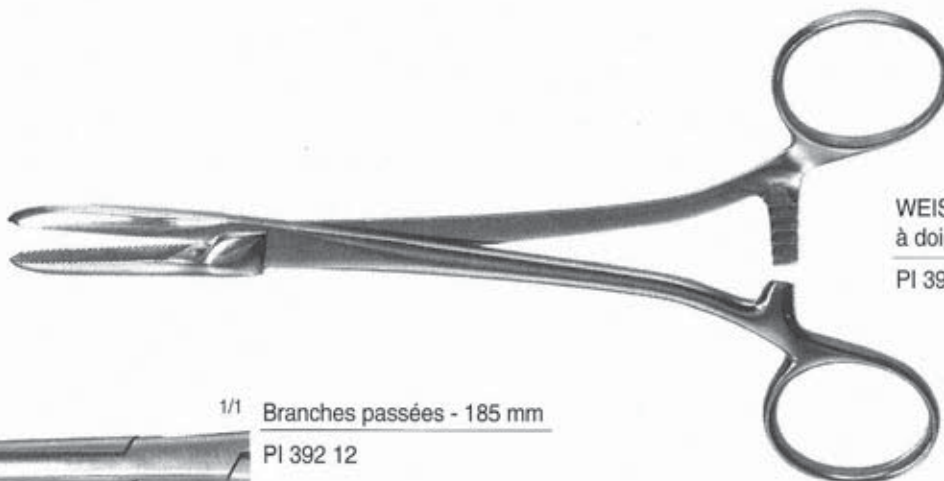

WEISS - 185 mm
à doigt (démontable)
PI 392 11

1/1 Branches passées - 185 mm
PI 392 12



PINCES PROSTATIQUES

MICHON - 230 mm
à doigt (démontable)
PI 393 01

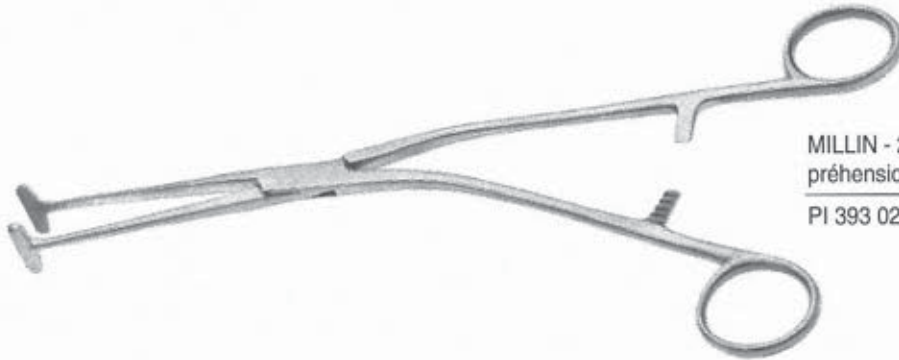
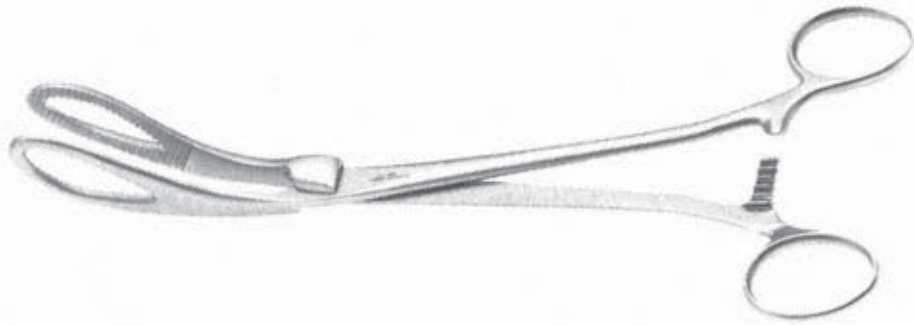

MILLIN - 230 mm
préhension de la lèvre inférieure
PI 393 02

MILLIN - 230 mm
préhension de la lèvre supérieure
PI 393 03



MILLIN - 230 mm
porte - ligature
PI 393 04



POINTES CARREES



^{1/1} ISELIN - 165 mm

-  PO 395 01 avec oeillet
-  PO 395 02 sans oeillet



OMBREDANNE

	2 mm	3 mm	4 mm	6 mm	8 mm	10 mm
165 mm	PO 395 03	PO 395 04				
185 mm		PO 395 05	PO 395 06	PO 395 07	PO 395 08	PO 395 09
250 mm		PO 395 10	PO 395 11	PO 395 12	PO 395 13	PO 395 14



ROCHER Ø 3 mm

- PO 395 15 150 mm
- PO 395 16 180 mm



TRILLAT

	3 mm	4 mm	6 mm
185 mm	PO 395 17	PO 395 18	PO 395 19
250 mm	PO 395 20	PO 395 21	PO 395 22



PORTE - AIGUILLES

BAUMGARTNER - 140 mm
 TUNGSTENE
 PO 397 01

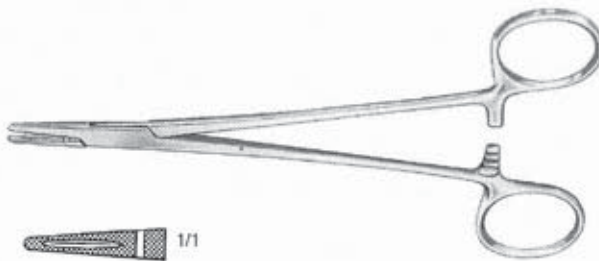
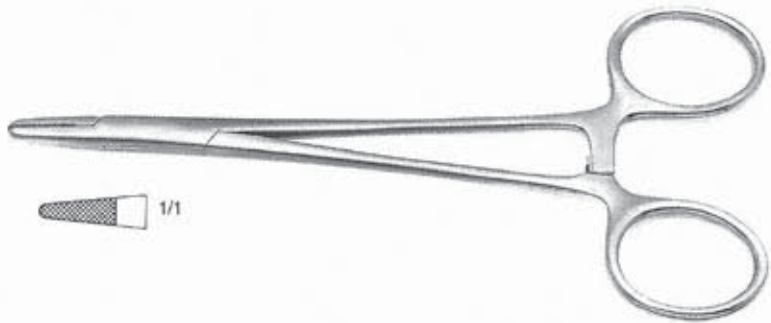

CRILE WOOD
 PO 397 02 150 mm
 PO 397 03 180 mm

CRILE WOOD
 TUNGSTENE
 PO 397 04 150 mm
 PO 397 05 180 mm
 PO 397 06 200 mm
 PO 397 07 230 mm
 PO 397 08 260 mm
 PO 397 09 300 mm

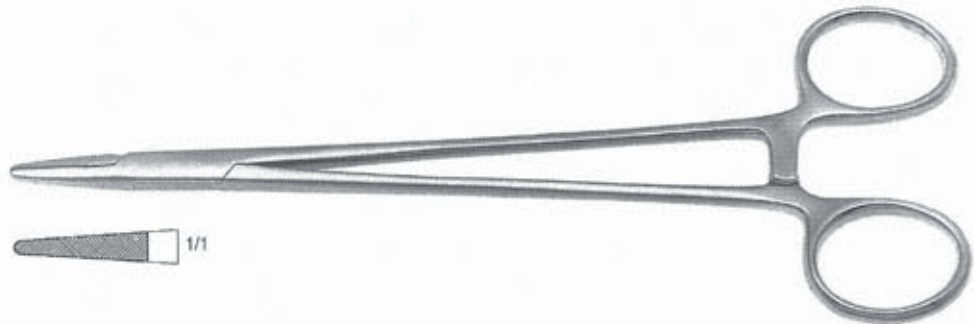

DEBAKEY - TUNGSTENE
 PO 397 10 180 mm
 PO 397 11 200 mm
 PO 397 12 230 mm
 PO 397 13 260 mm
 PO 397 14 300 mm



PORTE - AIGUILLES

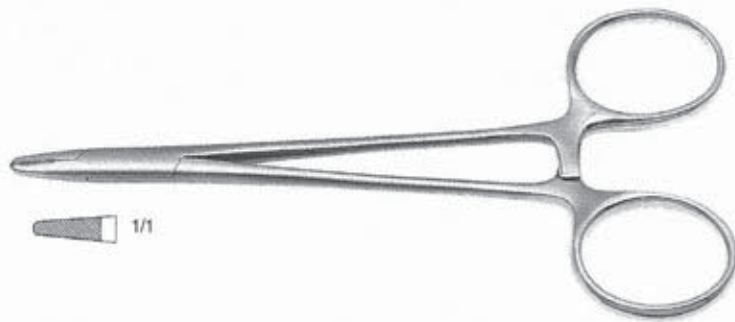

DERF - 120 mm
TUNGSTENE
PO 398 01



EUPHRATE PASQUE TUNGSTENE

PO 398 02	140 mm
PO 398 03	180 mm
PO 398 04	200 mm
PO 398 05	230 mm

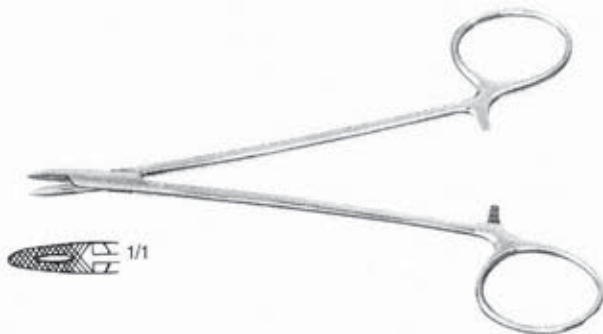
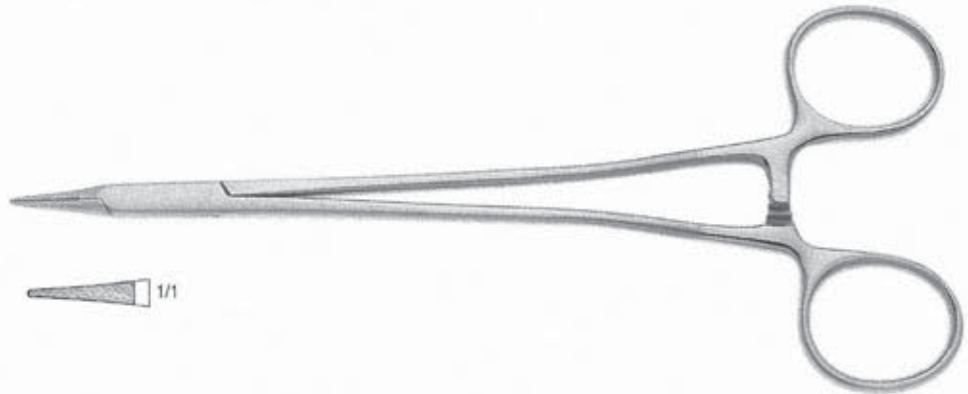

FINOCHIETTO DELICAT

PO 398 06	130 mm
PO 398 07	150 mm
PO 398 08	180 mm



GILLIES - 160 mm
TUNGSTENE
Porte aiguille - ciseaux
PO 398 09





GILLIES MINI
145 mm - TUNGSTENE
PO 399 01

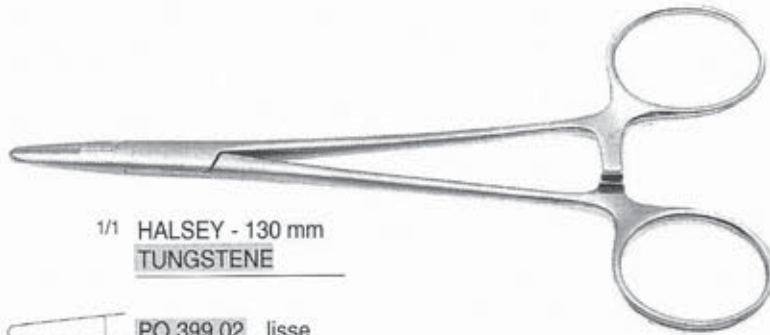

1/1 HALSEY - 130 mm
TUNGSTENE

HALSEY 130 mm
INOX

PO 399 05

PO 399 02 lisse

PO 399 03 standard

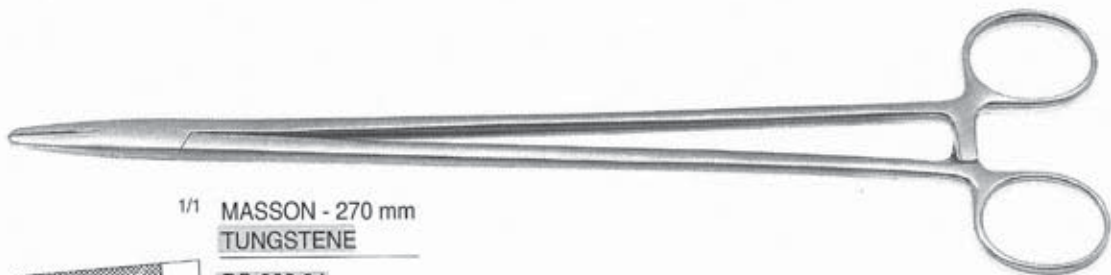

1/1 MASSON - 270 mm
TUNGSTENE

PO 399 04



PORTE - AIGUILLES



MATHIEU - TUNGSTENE

	140 mm	170 mm	200 mm
1/1			
STANDARD	PO 400 01	PO 400 02	PO 400 03
STANDARD ROBUSTE	PO 400 01 S	PO 400 02 S	PO 400 03 S
1/1			
DELICAT	PO 400 04	PO 400 05	PO 400 06

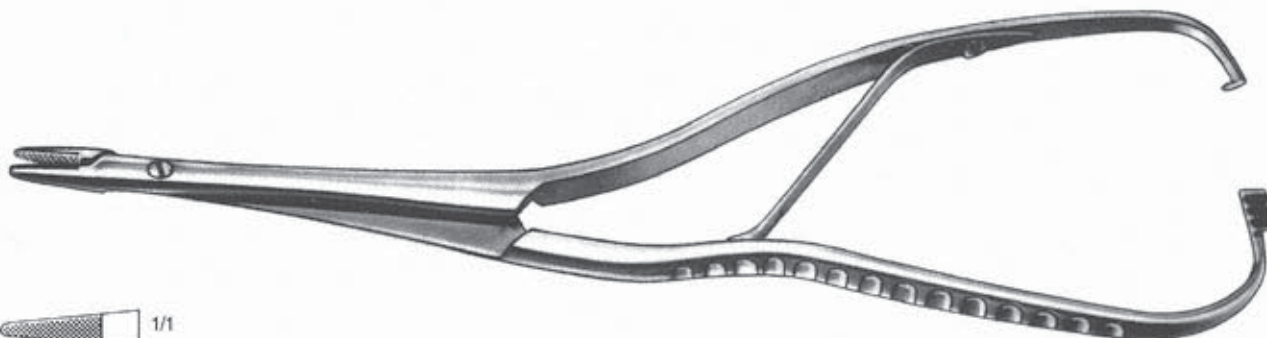

MATHIEU BAÏONNETTE 250 mm - TUNGSTENE

PO 400 07





MATHIEU ARRUGA 160 mm - TUNGSTENE

- 1/1
- PO 400 08 courbe
 - PO 400 09 droit



MATHIEU BOYNTON
120 mm - TUNGSTENE

- 1/1  PO 401 01 courbe
-  PO 401 02 droit

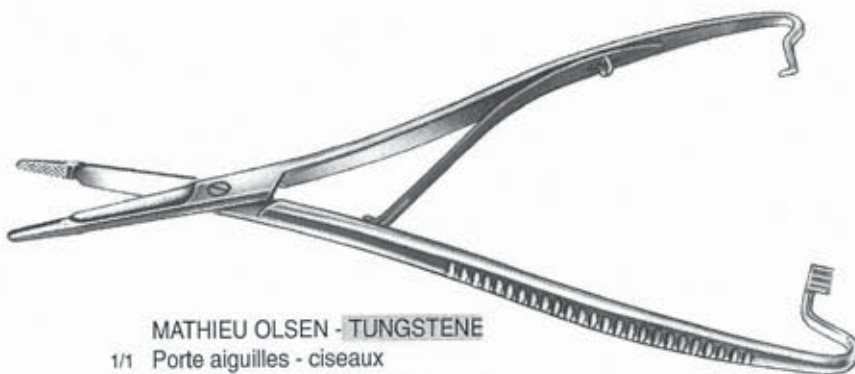







MATHIEU OLSEN - TUNGSTENE
1/1 Porte aiguilles - ciseaux

-  PO 401 03 140 mm
-  PO 401 04 170 mm
-  PO 401 05 200 mm



1/1 MAYO HEGAR

- | | | | |
|---|------------------|---|------------------|
|  | PO 401 06 140 mm |  | PO 401 09 200 mm |
|  | PO 401 07 160 mm |  | PO 401 10 240 mm |
|  | PO 401 08 180 mm |  | PO 401 11 260 mm |



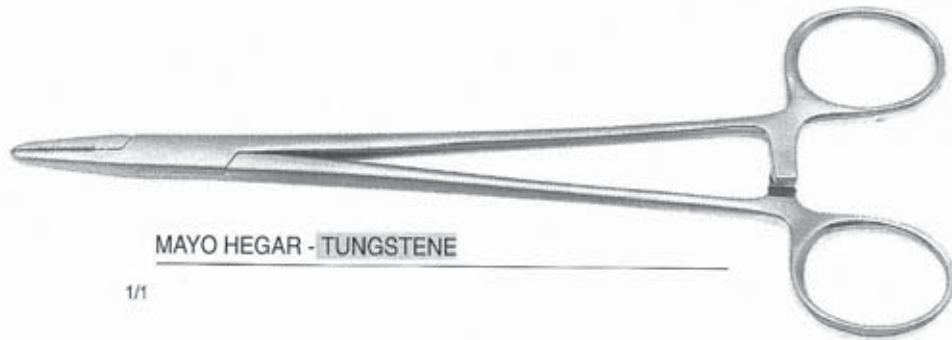

PORTE - AIGUILLES



MAYO HEGAR - TUNGSTENE

1/1

 PO 402 01 140 mm

 PO 402 02 160 mm

 PO 402 03 180 mm

 PO 402 04 200 mm

1/1

 PO 402 05 240 mm

 PO 402 06 260 mm

 PO 402 07 300 mm

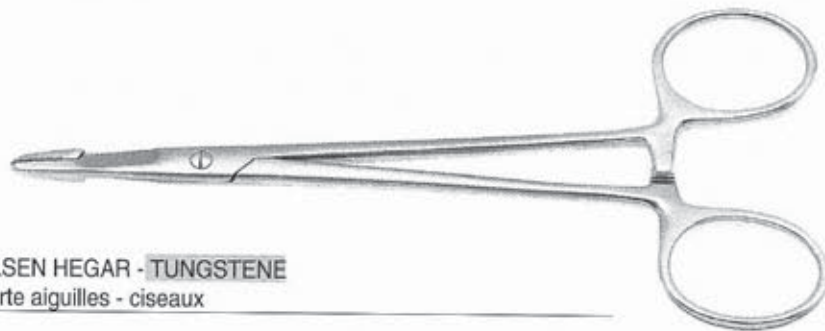

OLSEN HEGAR - TUNGSTENE
Porte aiguilles - ciseaux

1/1

 PO 402 08 120 mm (mini)

 PO 402 09 140 mm

1/1

 PO 402 10 170 mm

 PO 402 11 190 mm



OPHTALMO - 130 mm
PO 403 01



RYDER - TUNGSTENE

standard

mini



1/1



1/1

130 mm
150 mm
180 mm
200 mm
230 mm
260 mm

PO 403 02
PO 403 04
PO 403 06
PO 403 08
PO 403 10
PO 403 12

PO 403 03
PO 403 05
PO 403 07
PO 403 09
PO 403 11
PO 403 13

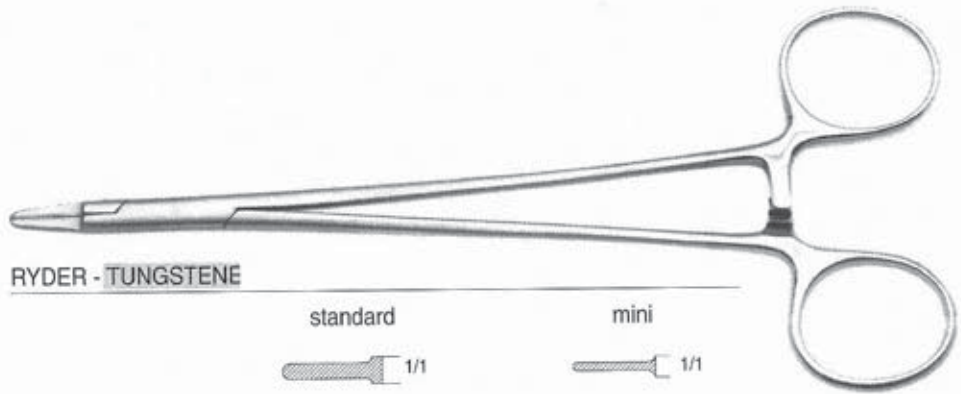

SAROT - TUNGSTENE

PO 403 14 180 mm
PO 403 16 200 mm
PO 403 15 270 mm



1/1

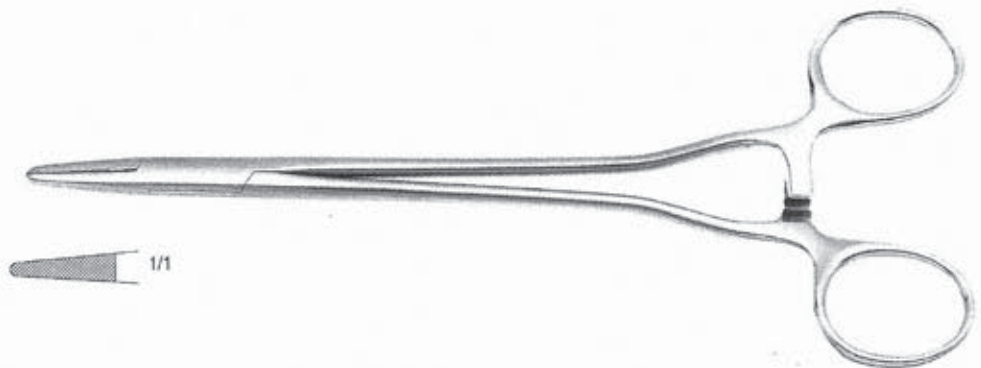



PORTE - AIGUILLES



STRATTE - 230 mm
TUNGSTENE
PO 404 01

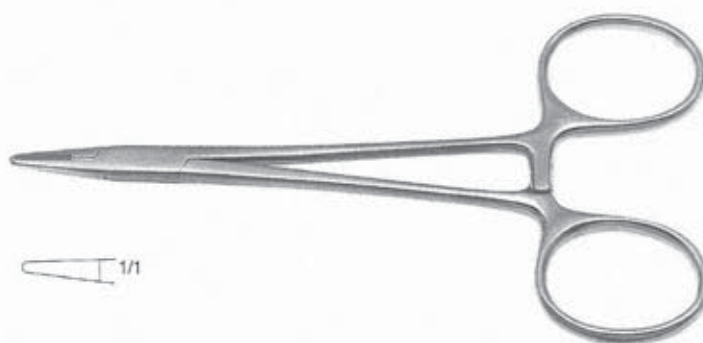

WEBSTER - 130 mm
TUNGSTENE
PO 404 02 mors lisse



YOUNG MILLIN - 250 mm
Porte aiguilles pour prostatectomie
avec une aiguille n°1
PO 404 03



aiguille
N°1
PO 404 04



N°2
PO 404 05



N°3
PO 404 06



PORTE - AIGUILLES MICRO



CASTROVIEJO - CORPS ROND

	AVEC VERROU		SANS VERROU	
	courbe	droit	courbe	droit
130 mm	PO 406 01	PO 406 02	PO 406 03	PO 406 04
150 mm	PO 406 05	PO 406 06	PO 406 07	PO 406 08

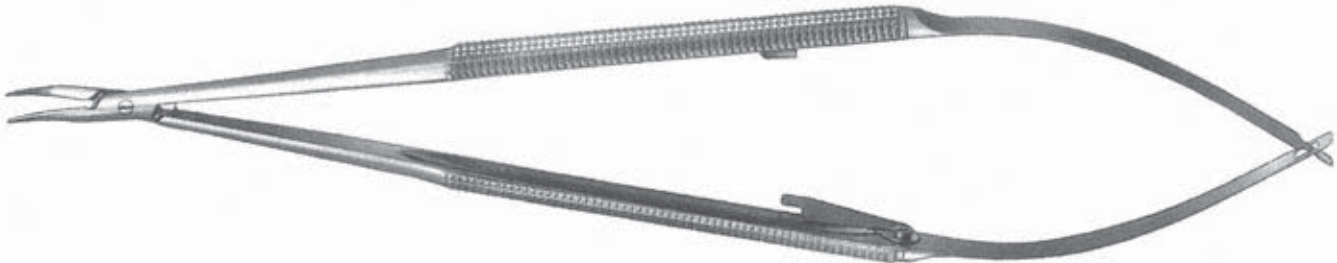

CASTROVIEJO - CORPS ROND





	AVEC VERROU		SANS VERROU	
	courbe	droit	courbe	droit
180 mm	PO 406 09	PO 406 10	PO 406 11	PO 406 12
210 mm	PO 406 13	PO 406 14	PO 406 15	PO 406 16



PORTE - AIGUILLES MICRO



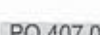







CASTROVIEJO - CORPS ROND - 140 mm
TUNGSTENE

	mors lisses	
	courbe	droit
à verrou	 1/1 PO 407 01	 1/1 PO 407 02
sans verrou	 1/1 PO 407 03	 1/1 PO 407 04











CASTROVIEJO - CORPS PLAT - 140 mm
TUNGSTENE

	mors lisses		mors striés	
	courbe	droit	courbe	droit
à verrou	 1/1 PO 407 05	 1/1 PO 407 06	 1/1 PO 407 07	 1/1 PO 407 08
sans verrou	 1/1 PO 407 09	 1/1 PO 407 10	 1/1 PO 407 11	 1/1 PO 407 12



JACOBSON - CORPS PLAT
TUNGSTENE

	mors lisses	
	courbe	droit
180 mm à verrou	 1/1 PO 407 13	 1/1 PO 407 14
220 mm à verrou	 1/1 PO 407 15	 1/1 PO 407 16
180 mm sans verrou	 1/1 PO 407 17	 1/1 PO 407 18
220 mm sans verrou	 1/1 PO 407 19	 1/1 PO 407 20



PORTE - AIGUILLES MICRO



YASARGIL - 185 mm
Baïonnette

1/1

 PO 408 01 courbe

1/1

 PO 408 02 droit

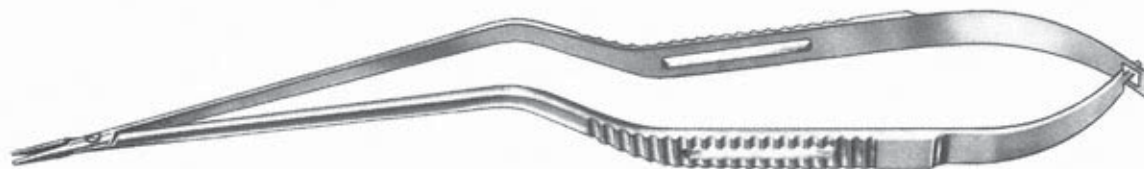

YASARGIL - 230 mm
Baïonnette

1/1

 PO 408 03 courbe

1/1

 PO 408 04 droit



PORTE - COTON

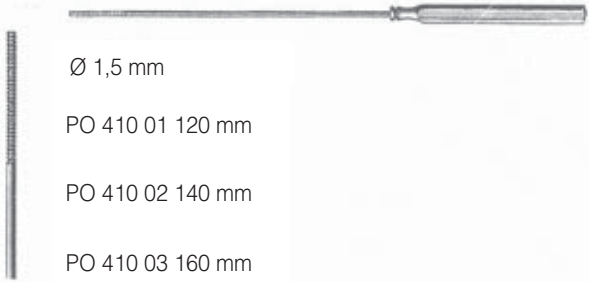

Ø 1,5 mm

PO 410 01 120 mm

PO 410 02 140 mm

PO 410 03 160 mm

1/1



PO 410 04 Ø 0,9 mm 140 mm

PO 410 05 Ø 1,2 mm 180 mm

PO 410 06 Ø 1,3 mm 230 mm

1/1



PO 410 07 380 mm 2 x 3 griffes



R

PAGES

RAPES - ORL - OSSEUSES 414 - 415

RAPPROCHEURS COSTAUX 416

RONGEURS

A DISQUE INTERVERTEBRAL 418 - 421

A LAMES VERTEBRALES 423 - 425

ORL 427 - 428

RUGINES 430 - 440



RASPATOIRS
RETRACTEUR A AMPUTATION

VOIR
VOIR

RUGINES
SCIES



RAPES

1/2



AUFRICT - 210 mm

en tirant

en poussant

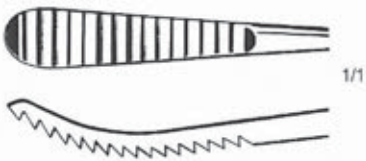

1/1

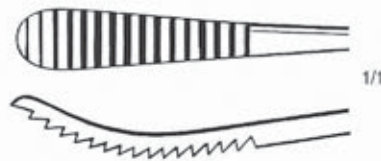

1/1

RA 414 01

RA 414 02

1/2



1/1 COTTLE - 210 mm

RA 414 03

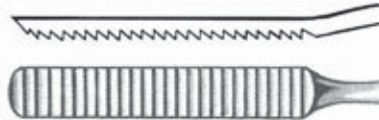

1/2

GALLAHER - 160 mm



1/1

droite
RA 414 04



1/1

coudée à droite
RA 414 05

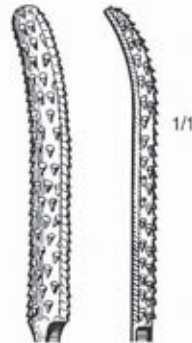

1/1

coudée à gauche
RA 414 06



1/2

1/1 LEWIS - 180 mm



RA 415 01



1/2

1/1 MALTZ - 180 mm

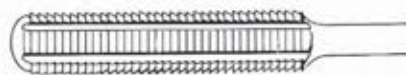

RA 415 02



1/2



1/1 PUTTI - 300 mm



RA 415 03



1/1 PUTTI - 240 mm

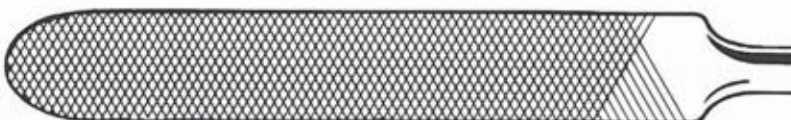

RA 415 04 largeur 13 mm



RAPPROCHEURS COSTAUX



ABLAZA- MORSE - 150 mm
Profondeur des mors : 33 mm
 RA 416 01



BAILEY - 180 mm - adulte
Profondeur des mors : 25 mm
 RA 416 02

BAILEY - 160 mm - enfant
Profondeur des mors : 20 mm
 RA 416 03

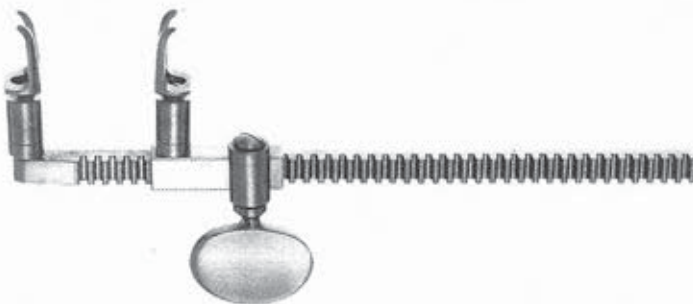







SELLORS - 200 mm - valves pivotantes
Profondeur des mors : 40 mm
 RA 416 06









RONGEURS A DISQUE INTERVERTEBRAL

CASPAR - Démontable

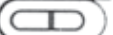

MORS PLEINS			
			
	droit	coudé haut	coudé bas
longueur totale	150 mm		
largeur du mors			
 2 mm	418 20	418 21	418 01
 3 mm	418 22	418 23	418 02
 4 mm	418 25	418 26	418 03

MORS FENETRES									
									
	droit			coudé haut			coudé bas		
longueur totale	140 mm	160 mm	180 mm	140 mm	160 mm	180 mm	140 mm	160 mm	180 mm
largeur du mors									
 2 mm	418 27	418 30	418 35						
 3 mm	418 28	418 31	418 36	418 40	418 42	418 45	418 48	418 50	418 52
 4 mm	418 29	418 32	418 37	418 41	418 43	418 46	418 49	418 51	418 53
 5 mm		418 33	418 38		418 44	418 47			
 6 mm		418 34	418 39						



RONGEURS A DISQUE INTERVERTEBRAL

CUSHING - Démontable

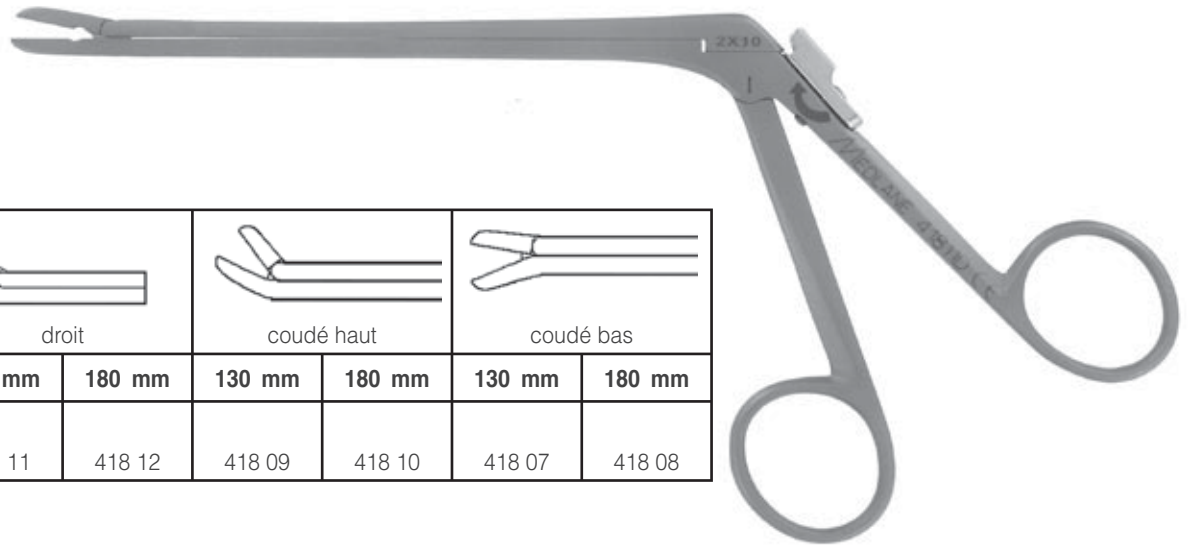

	droit		coudé haut		coudé bas	
longueur totale	130 mm	180 mm	130 mm	180 mm	130 mm	180 mm
largeur du mors	2 mm					
	418 11	418 12	418 09	418 10	418 07	418 08

CLOWARD

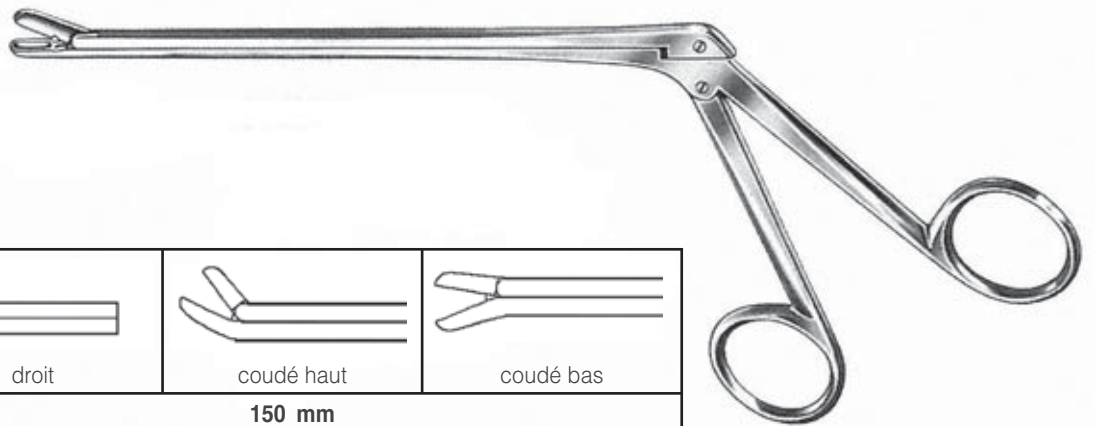

	droit	coudé haut	coudé bas
longueur totale	150 mm		
largeur du mors	6 mm		
	418 06	418 05	418 04



RONGEURS A DISQUE INTERVERTEBRAL

FERRIS SMITH

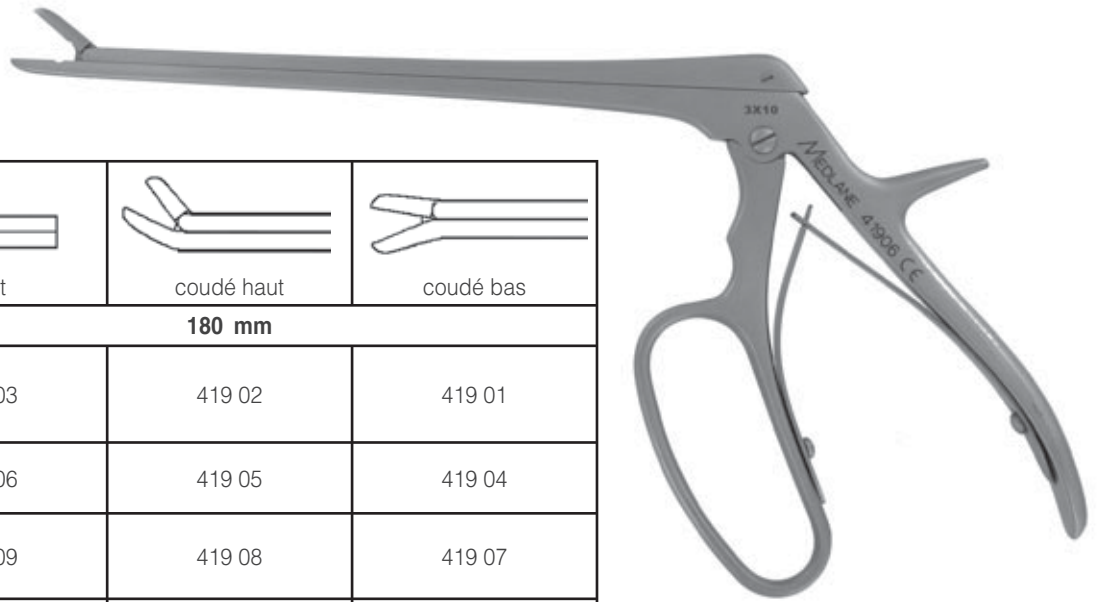

droit	coudé haut	coudé bas

longueur totale	180 mm		
largeur du mors			
2 mm	419 03	419 02	419 01
3 mm	419 06	419 05	419 04
4 mm	419 09	419 08	419 07
6 mm	419 12	419 11	419 10

LOVE GRUNWALD

Démontable

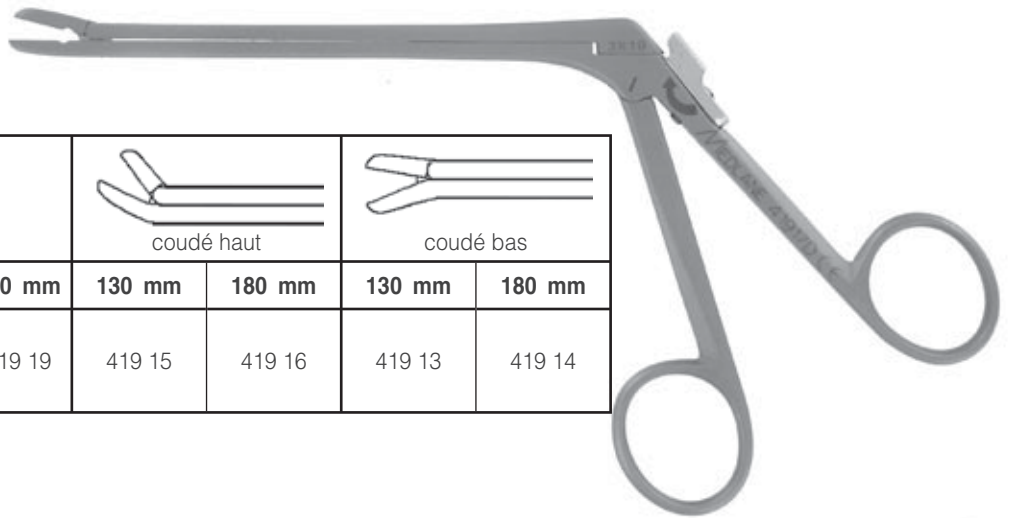

droit	coudé haut		coudé bas	

longueur totale	130 mm	180 mm	250 mm	130 mm	180 mm	130 mm	180 mm
Largeur du mors							
3 mm	419 17	419 18	419 19	419 15	419 16	419 13	419 14

OLDBERG

419 20

Longueur : 180 mm

Diamètre du mors : **6 mm**





RONGEURS A DISQUE INTERVERTEBRAL

PERTUISET - 145 mm





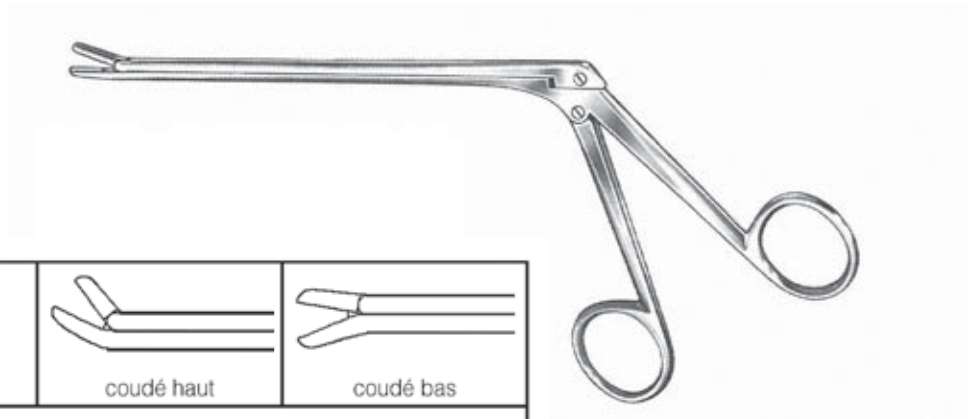

largeur x longueur

420 01 mors: 4 x 8 mm à griffes



SCHLESINGER



	 droit	 coudé haut	 coudé bas
longueur totale	150 mm		
Largeur du mors  1.5 mm	420 04	420 03	420 02
 2 mm	420 05		
 3 mm	420 06		
 4 mm	420 07		



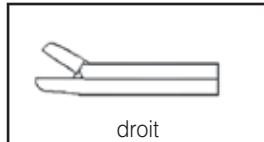

RONGEURS A DISQUE INTERVERTEBRAL

SELVERSTONE



droit

longueur totale	150 mm
 largeur x longueur du mors 2 X 3 mm	421 01
 2 X 5 mm	421 02

SPURLING - Démontable

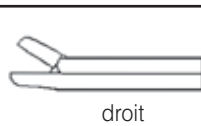
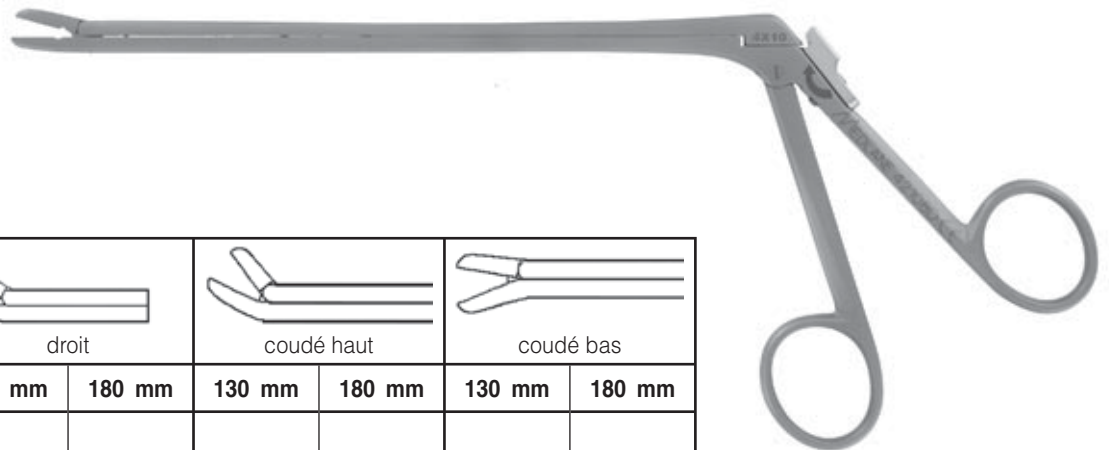

droit

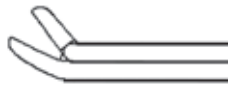

coudé haut

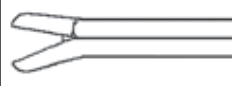

coudé bas

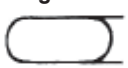
						
longueur totale	130 mm	180 mm	130 mm	180 mm	130 mm	180 mm
Largeur du mors	421 07	421 08	421 05	421 06	421 03	421 04

RONGEURS A LAMES VERTEBRALES

LAMINA PUNCH - avec ejecteur

Petit manche

ouverture 10 mm

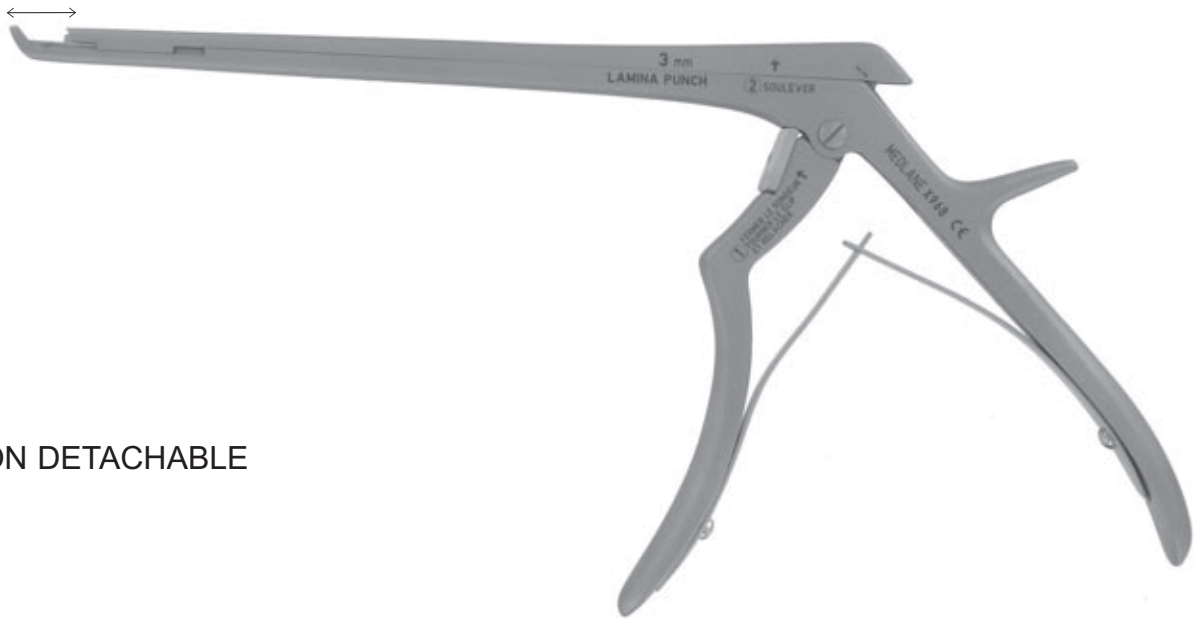

DEMONTABLE NON DETACHABLE

	 COUPE EN HAUT 90 °			 COUPE EN HAUT 40 °			 COUPE BAS A 90 °		 COUPE BAS A 40 °	
Longueur en mm	180	200	250	180	200	250	180	200	180	200
Largeur du mors										
1 mm	42346*			42349*			42348*		42347*	
2 mm	42350*		42354*	42352*		42355*	42351*		42353*	
3 mm	42356	42357		42360	42361	42362	42358	42359	42363	42364
4 mm	42365	42366		42369	42370	42371	42367	42368	42372	42373
5 mm	42374	42375	42376	42379	42380	42381	42377	42378	42382	42383
6 mm	42384	42385		42386	42387					

(*) EN RAISON DE LA FAIBLE LARGEUR, CES MODELES NE POSSEDENT PAS D'EJECTEUR



RONGEURS A LAMES VERTEBRALES

CLOWARD

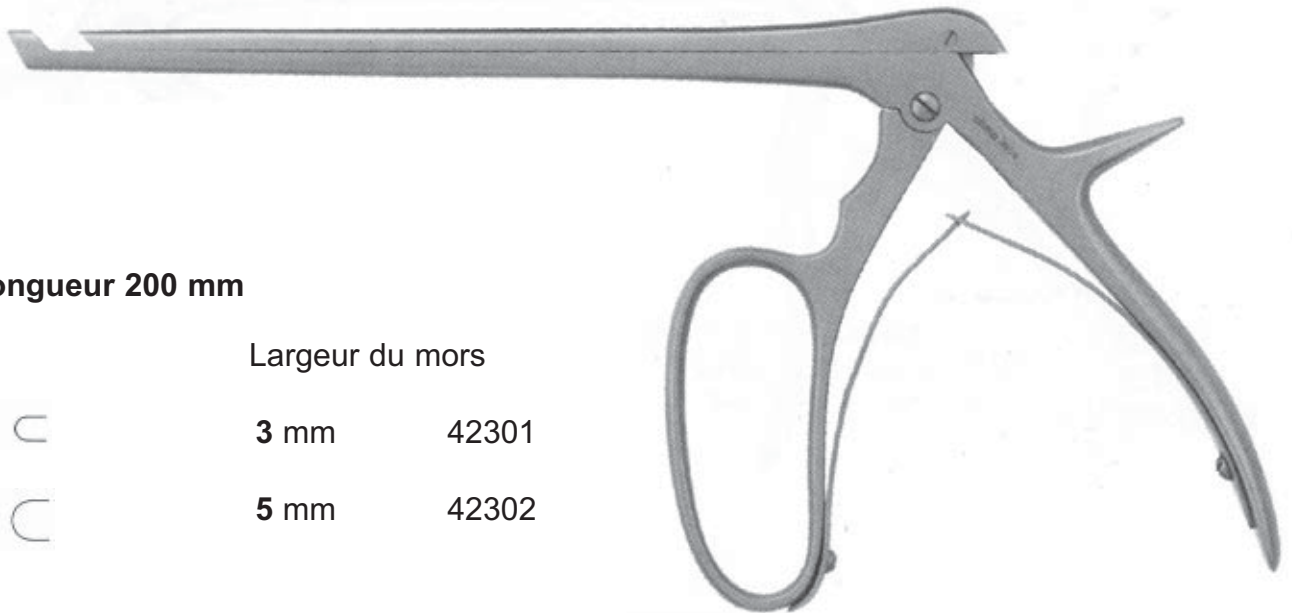

Longueur 200 mm

Largeur du mors



3 mm 42301



5 mm 42302

DEMANDER

NOTRE CATALOGUE SPECIAL

RONGEURS "CERAMIC"



RONGEURS A LAMES VERTEBRALES

LAMINA PUNCH

Gros manche

ouverture 17 mm



DEMONTABLE

	coupe en haut à 90°			coupe en haut à 40°		
longueur totale	180 mm	200 mm	250 mm	180 mm	200 mm	250 mm
largeur du mors 3 mm	424 45	424 46	424 47	424 48	424 49	424 50
4 mm	424 51	424 52	424 53	424 54	424 55	424 56
5 mm	424 57	424 58	424 59	424 60	424 61	424 62
6 mm	424 63	424 64	424 65	424 66	424 67	424 68



RONGEURS A FORAMEN

FORAMEN Courbe

Longueur 200 mm

Largeur du mors	référence
3 mm	425 01
4 mm	425 02
5 mm	425 03

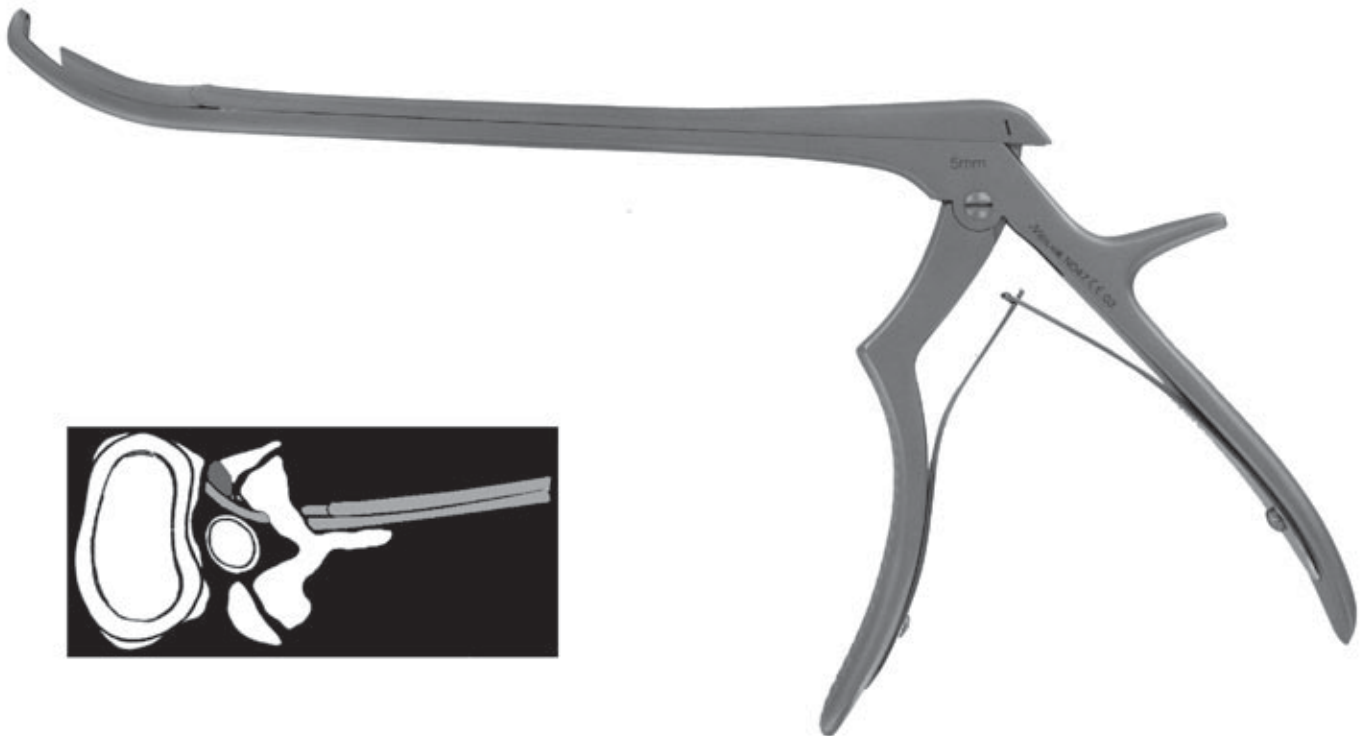

AVANTAGES : Abord facilité par la courbure de la tige qui limite ainsi les risques dans le canal interspinal et épidual.



RONGEURS O.R.L.

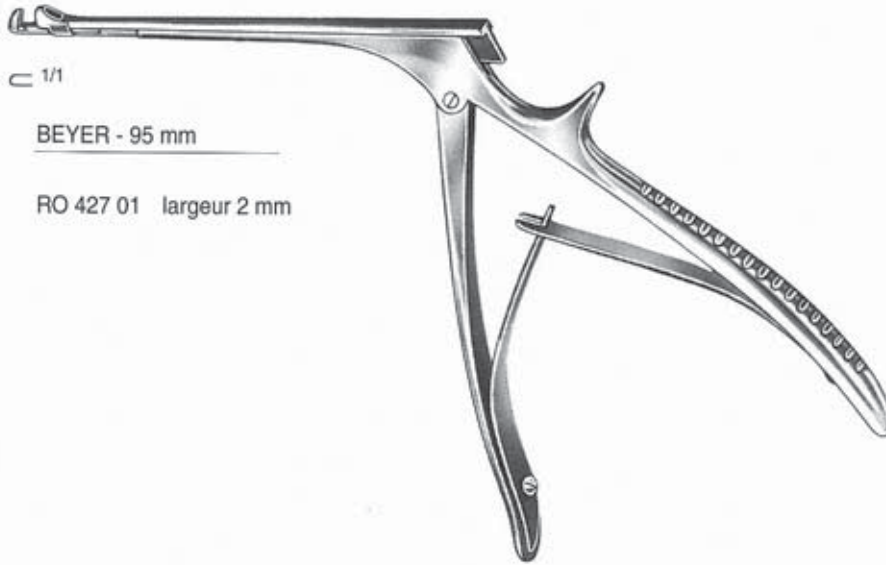

C 1/1

BEYER - 95 mm

RO 427 01 largeur 2 mm

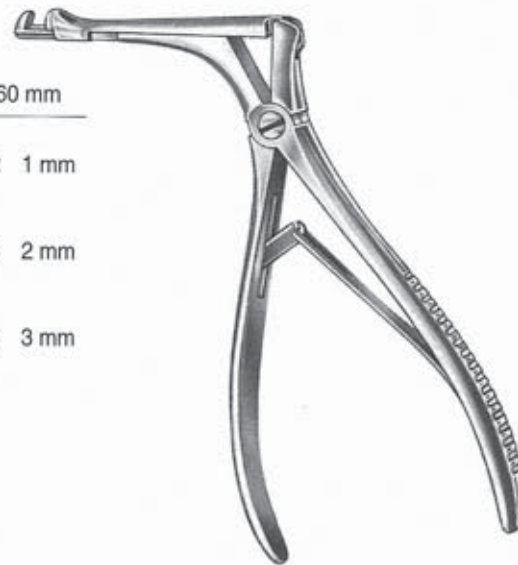

CITELLI - 60 mm

1/1

RO 427 02 1 mm

RO 427 03 2 mm

RO 427 04 3 mm

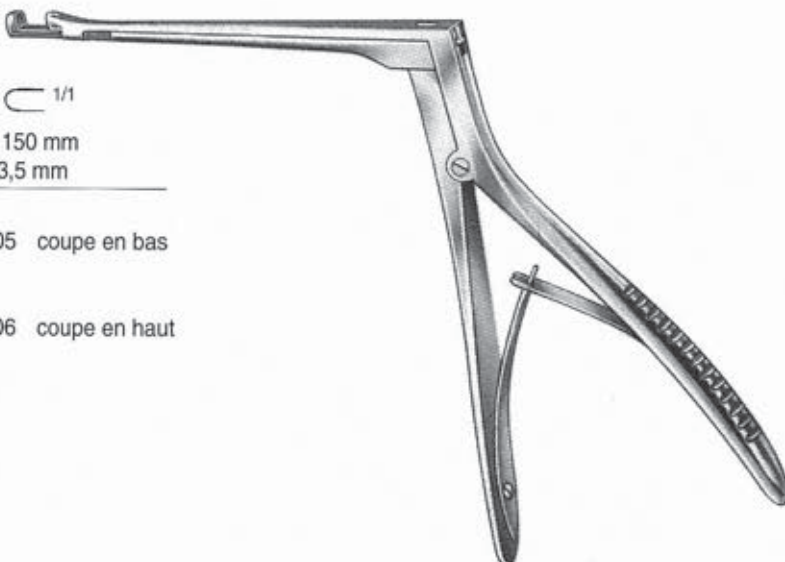

C 1/1

HAJEK - 150 mm
mors de 3,5 mm

RO 427 05 coupe en bas

RO 427 06 coupe en haut



RONGEURS O.R.L.

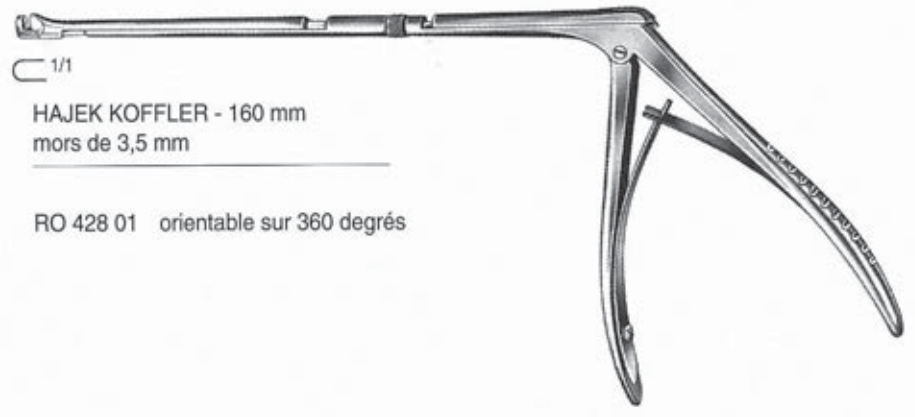

1/1
HAJEK KOFFLER - 160 mm
mors de 3,5 mm

RO 428 01 orientable sur 360 degrés



1/1 KERRISON - 70 mm

RO 428 02 3 mm

RO 428 03 4 mm

RO 428 04 5 mm



RUGINES



CHOMPRET - 150 mm (SYNDESMOTOMES)

- RU 430 01 droit
- RU 430 02 coudé à 45 degrés
- RU 430 03 courbe en faucille
- RU 430 04 courbe à 70 degrés

COBB - 280 mm - POUR LE RACHIS



4 mm RU 430 05



6 mm RU 430 06



8 mm RU 430 07



9 mm RU 430 08



10 mm RU 430 09



12 mm RU 430 10

COBB - 240 mm - POUR LE RACHIS



9 mm RU 430 11



13 mm RU 430 12



19 mm RU 430 13



DOYEN - 180 mm ADULTE - COSTALE

RU 431 01 coudée à droite

RU 431 02 coudée à gauche



DOYEN - 180 mm ENFANT - COSTALE

RU 431 03 coudée à droite

RU 431 04 coudée à gauche

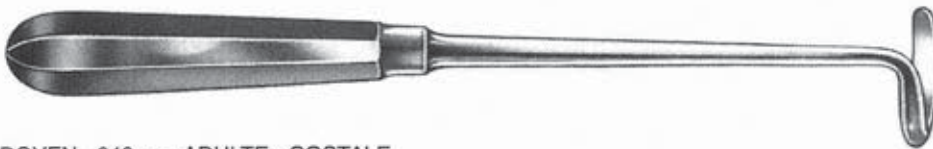

DOYEN - 240 mm ADULTE - COSTALE

RU 431 05 coudée à droite

RU 431 06 coudée à gauche



FARABEUF - 160 mm

	courbe	droite
4 mm	RU 431 07	RU 431 08
6 mm	RU 431 09	RU 431 10
8 mm	RU 431 11	RU 431 12
10 mm	RU 431 13	RU 431 14
12 mm	RU 431 15	RU 431 16
14 mm	RU 431 17	RU 431 18



RUGINES



FOMON - 170 x 4 mm

RU 432 01 droite



FRUCHAUD - 200 x 10 mm - COSTALE

RU 432 02 pour le bord inférieur



FRUCHAUD - 200 x 10 mm - COSTALE

RU 432 03 rétrograde



HOWARTH - 210 mm - MAXILLO

RU 432 04 rugine - spatule

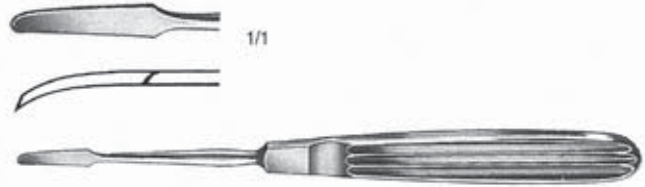

JOSEPH - 160 mm - courbe
RU 433 01 largeur 4 mm



JOSEPH - 220 mm
en baïonnette
RU 433 02 largeur 4 mm



LAMBOTTE - 210 mm

RU 433 03	5 mm	RU 433 07	18 mm
RU 433 04	10 mm	RU 433 08	20 mm
RU 433 05	12 mm	RU 433 09	25 mm
RU 433 06	14 mm		



RUGINES

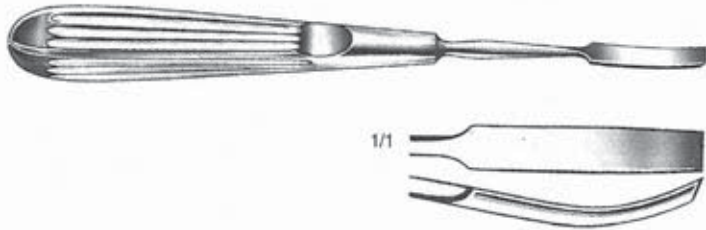

LEMPERT - 180 mm - courbe
RU 434 01 largeur 4 mm

LEMPERT - 210 mm - demi-courbe
RU 434 02 largeur 4 mm

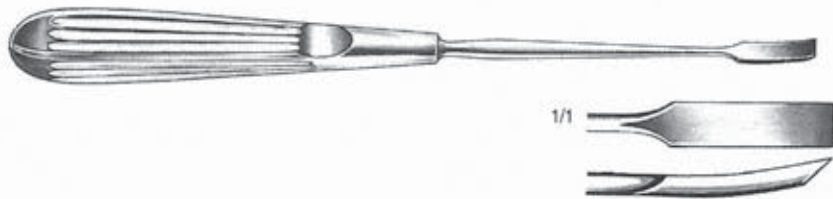

LERICHE - 130 mm

	concave	convexe
9 mm	RU 434 03	RU 434 04
13 mm	RU 434 05	RU 434 06



MAURER - 265 mm en fourche - courbe
- COSTALE

- RU 434 07 6 mm
RU 434 08 12 mm





MAURER COLLIN - 260 mm - COSTALE

demi-courbe

courbe



6 mm
12 mm

RU 435 01
RU 435 03

RU 435 02
RU 435 04



MERLE D'AUBIGNE - 240 mm - courbe

RU 435 05	3 mm	RU 435 08	8 mm
RU 435 06	4 mm	RU 435 09	10 mm
RU 435 07	6 mm		



MERLE D'AUBIGNE à LIGAMENT JAUNE

RU 435 10 200 x 7 mm



MOREL FATIO - 220 x 4 mm - MAXILLO

RU 435 11



RUGINES

OBWEGESER - 175 mm - courbe - MAXILLO



1/1		6 mm	RU 436 01
1/1		7 mm	RU 436 02
1/1		9 mm	RU 436 03
1/1		11 mm	RU 436 04

OBWEGESER - 200 mm - coudée



1/1		1/1		1/1	
5 mm	RU 436 05	7 mm	RU 436 06	9 mm	RU 436 07

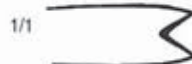

OBWEGESER - 175 mm
en queue d'aronde
RU 436 08 9 mm



OBWEGESER - 235 x 10 mm - courbe - MAXILLO
RU 437 01

1/1



1/1

OBWEGESER - 210 mm

RU 437 02 rugine dissecteur courbe

OBWEGESER - 210 mm

RU 437 03 rugine dissecteur
très courbe



1/1



RUGINES



OLLIER - 160 mm

	concave	convexe
6 mm	RU 438 01	RU 438 02
8 mm	RU 438 03	RU 438 04
10 mm	RU 438 05	RU 438 06
12 mm	RU 438 07	RU 438 08
14 mm	RU 438 09	RU 438 10

OLLIER - 160 mm modèle NEURO

- RU 438 11 10 mm
- RU 438 12 12 mm
- RU 438 13 13 mm



ROUX - 185 mm

- RU 438 14 5 mm
- RU 438 15 11 mm

SEBILEAU - 150 x 3 mm

- RU 438 16 courbe
- RU 438 17 droite





SEMB - COSTALE

1/2



RU 439 01 12 x 195 mm



RU 439 02 12 x 210 mm



RU 439 03 12 x 195 mm



RU 439 04 13 x 220 mm



RU 439 05 13 x 215 mm



RU 439 06 15 x 220 mm



RU 439 07 15 x 220 mm



RUGINES



TRILLAT - 220 mm

RU 440 01	8 mm	RU 440 04	14 mm
RU 440 02	10 mm	RU 440 05	16 mm
RU 440 03	12 mm		



WILLIGER - 160 mm

RU 440 06	4 mm
RU 440 07	6,5 mm



YASARGIL - 190 mm - neurochirurgie - DROITE

1/1



RU 440 08 légèrement courbe 2,5 mm



1/1



RU 440 09 très courbe 3 mm



1/1



YASARGIL - 190 mm BAÏONNETTE

RU 440 10 légèrement courbe 2,5 mm



1/1



RU 440 11 courbe en avant 2 mm



1/1



RU 440 12 courbe en arrière 2 mm



S

	PAGES
SCIES	443 - 445
SEMELLES	447
SERRE-FILS	447
SERRE NOEUDS	448 - 449
SONDES	451 - 452
SPATULES	453
SPECULUMS	
GYNECO	445 - 461
ORL AURICULAIRES	459
ORL RHINOLOGIE	460 - 461
STYLETS	462



STRIPPER DE VOLMAR
SYNDESMOTOMES

VOIR
VOIR

ANNEAUX
RUGINES



SCIES



DOS MOBILE - 300 mm

SC 443 01 complète

SC 443 02 lame seule

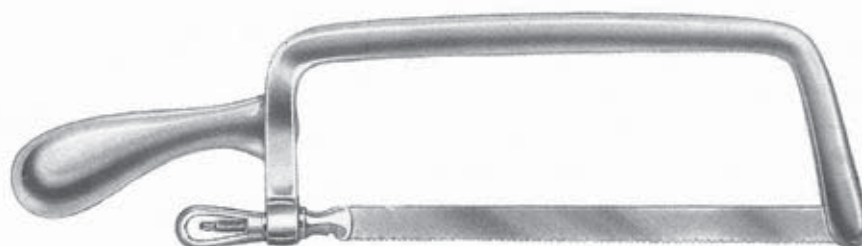

FARABEUF - 350 mm

SC 443 03 complète avec 2 lames

SC 443 04 lame seule largeur 12 mm

SC 443 05 lame seule largeur 15 mm

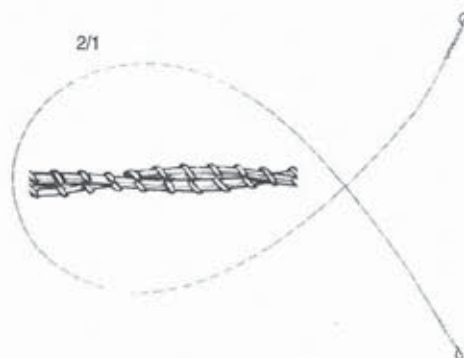

GIGLI en FIL soudé (OLIVE CRONA SUEDOISE)

SC 443 06 300 mm

SC 443 12 400 mm

SC 443 07 500 mm

SC 443 08 700 mm

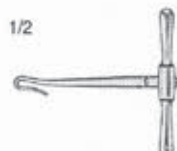

SC 443 09 poignée seule



CONDUCTEUR DE DEMARTEL POUR SCIE EN FIL

SC 443 10 avec sabot

SC 443 11 sans sabot



SCIES

JOSEPH - 200 mm



SC 444 01 coudée à gauche

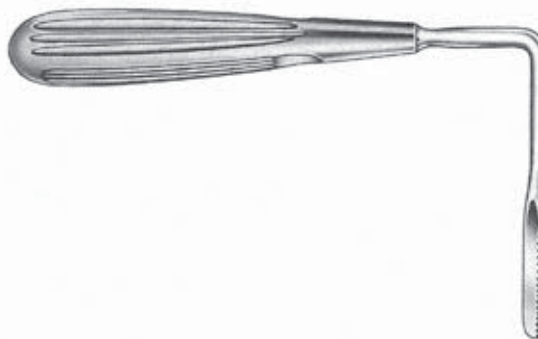

SC 444 02 coudée à droite

JOSEPH - 190 mm en baïonnette



SC 444 03 coudée à gauche



SC 444 04 coudée à droite





SCIES



LANGENBECK - 230 mm
SC 445 01

POSTEL - 235 mm

SC 445 02 complète

SC 445 03 lame seule

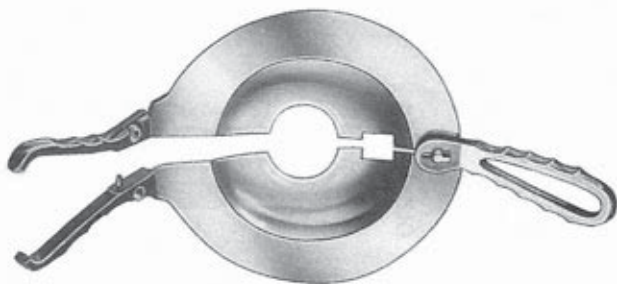

PERCY
rétracteur à amputation
SC 445 04



SEMELLE

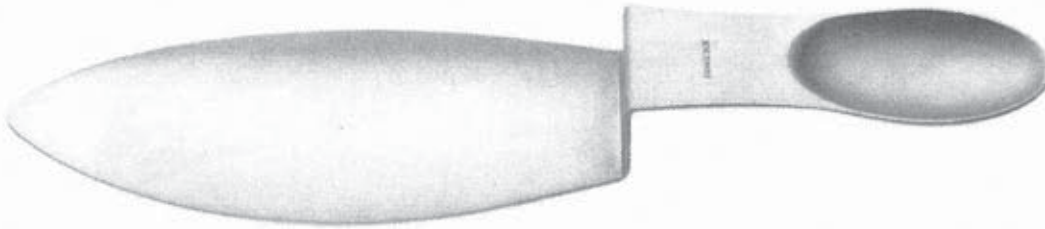

PAUCHET - 290 mm
SE 447 01

SERRE -FILS



LOUTE - 210 mm
SE 447 02

1/2



SERRE NŒUDS

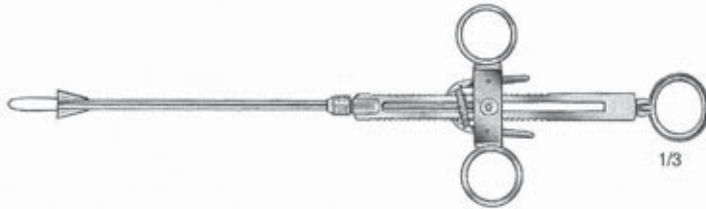

BRUNNINGS - 280 mm
pour amygdales
SE 448 01

1/3

KRAUSE- VOSS - 180 mm
pour polypes auriculaires
SE 448 02

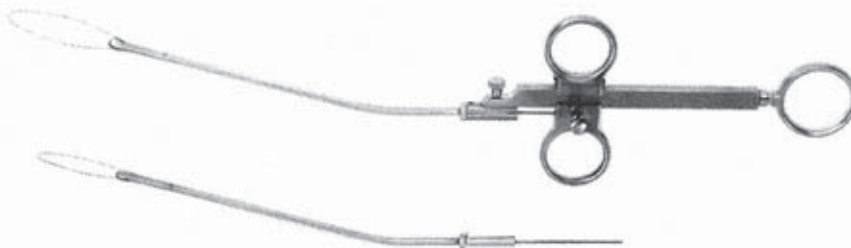

KRAUSE- VOSS - 260 mm
pour polypes du nez
avec 2 embouts tubulaires,
l'un vertical, l'autre horizontal
SE 448 03



SERRE NŒUDS

NORWOOD - 300 mm (longueur utile)
pour polypes rectaux

SE 449 01



VACHER
pour amygdales

SE 449 02

Fil d'Acier Rouleau 10 mètres

SE 449 03 0,2 mm

SE 449 04 0,3 mm

SE 449 05 0,4 mm

SE 449 06 0,5 mm





SONDES



BOUTONNEE - 140 mm
en feuille de myrte
 SO 451 01

CANNELEE

SO 451 02 120 mm

SO 451 03 140 mm



CANNELEE BOUTONNEE - 145 mm
 SO 451 04



KONIG - 195 x 2,5 mm

SO 451 05



KONIG - 195 x 5 mm

SO 451 06

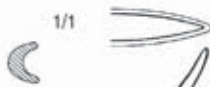

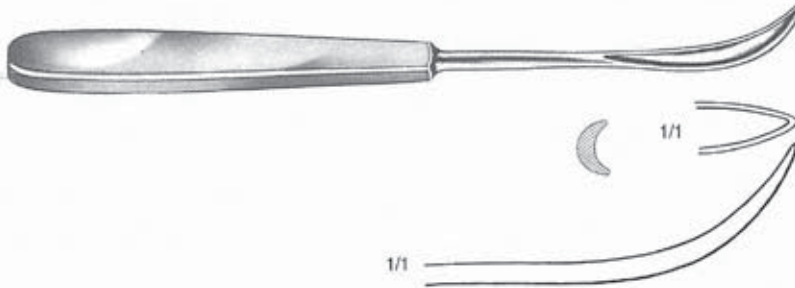

KONIG - 195 x 7 mm
SO 452 01



OCHSNER - 350 mm - FLEXIBLE
voies biliaires
SO 452 02



SPATULES

CLOVIS VINCENT MALLEABLE - spatules cérébrales

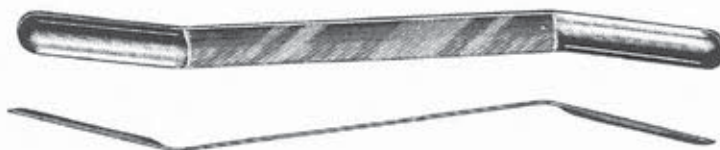
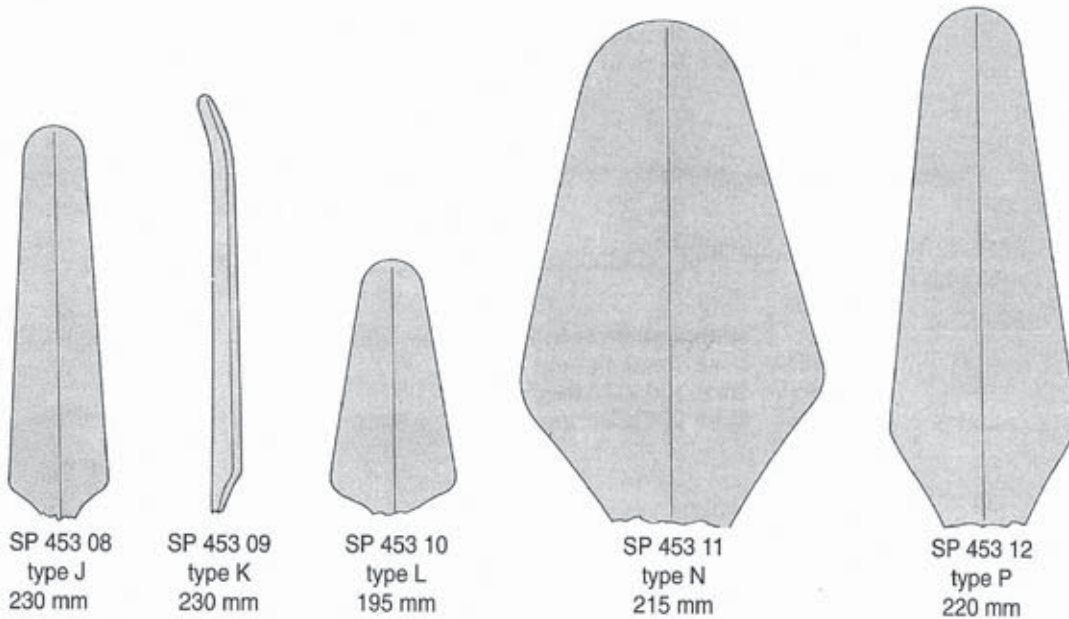
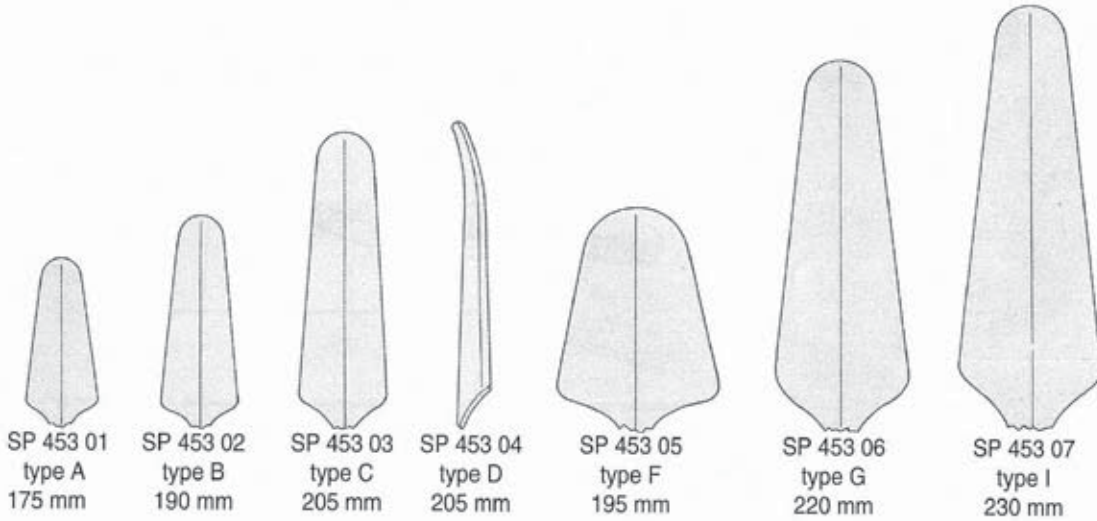

OLIVECRONA - 180 mm spatules cérébrales

- SP 453 13 7 x 9 mm
- SP 453 14 11 x 13 mm
- SP 453 15 15 x 18 mm
- SP 453 16 18 x 22 mm



SPECULUMS GYNECO

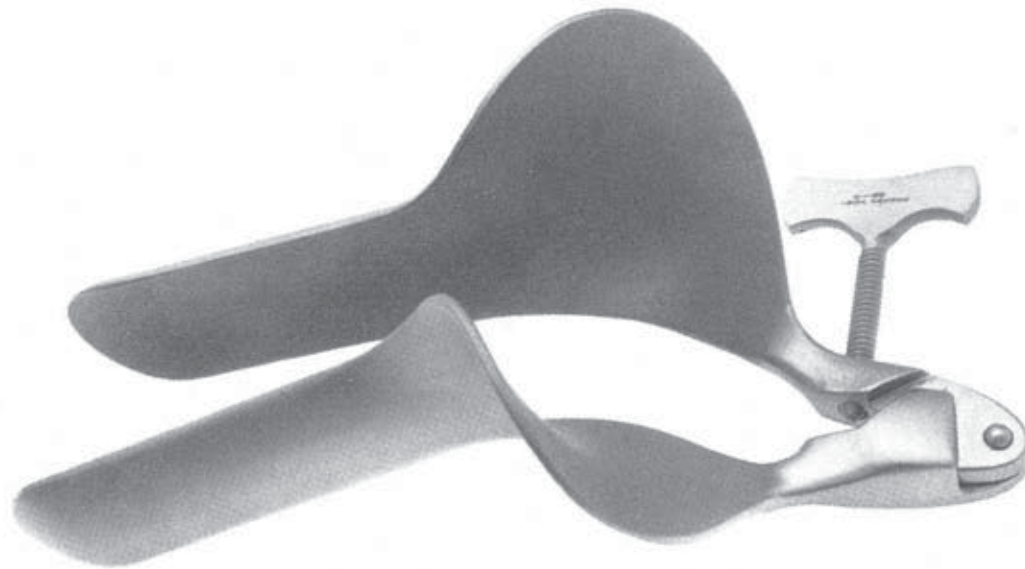

COLLIN MONOBLOC

bague en laiton
vis à pas rapide

	longueur utile
SP 455 01	16 x 90 mm
SP 455 02	26 x 90 mm
SP 455 03	30 x 90 mm
SP 455 04	32 x 105 mm
SP 455 05	35 x 105 mm
SP 455 06	38 x 105 mm



COLLIN MONOBLOC LASER

	longueur utile
SP 455 07	16 x 90 mm
SP 455 08	26 x 90 mm
SP 455 09	30 x 90 mm
SP 455 10	32 x 105 mm
SP 455 11	35 x 105 mm
SP 455 12	38 x 105 mm



SPECULUMS GYNECO



CUSCO FIXE

SP 456 01	16 x 100 mm
SP 456 02	25 x 100 mm
SP 456 03	32 x 100 mm
SP 456 04	35 x 100 mm
SP 456 05	40 x 100 mm

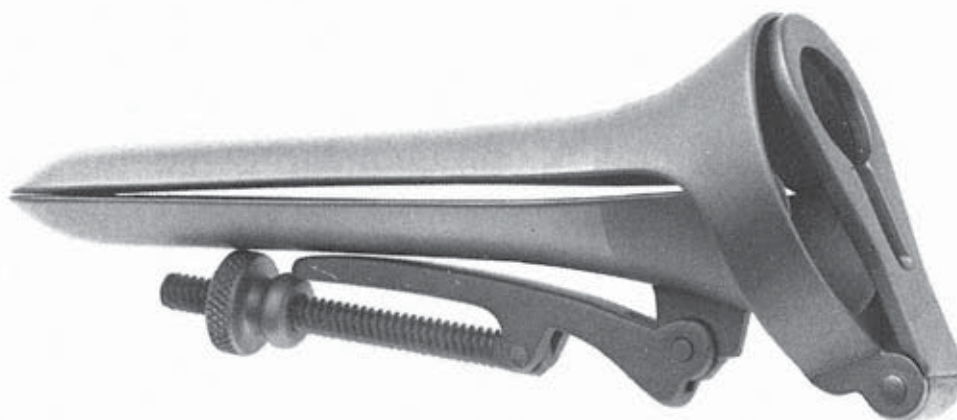

CUSCO PLIANT

SP 456 06	16 x 100 mm
SP 456 07	20 x 100 mm
SP 456 08	25 x 100 mm
SP 456 09	28 x 100 mm
SP 456 10	30 x 100 mm
SP 456 11	32 x 100 mm
SP 456 12	36 x 100 mm



SP

MEDLANE

SPECULUMS GYNECO

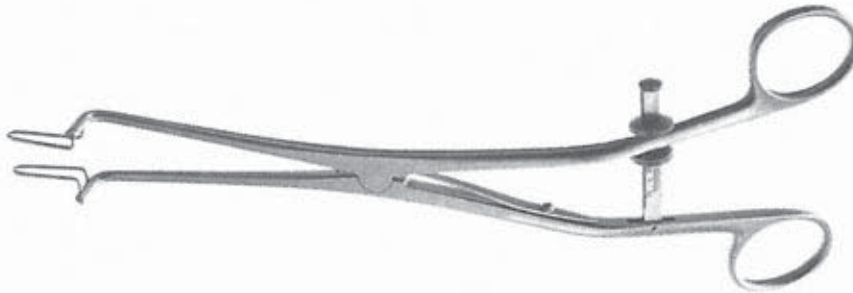

KOGAN - 240 mm
spéculum endo-cervical

SP 457 01 avec crémaillère
pas de vis gradué

SP 457 02 sans crémaillère

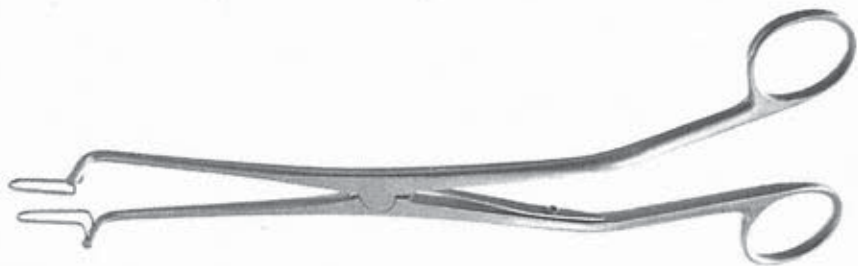



SPECULUMS ORL AURICULAIRES



HARTMANN

- Ø 3 mm
- Ø 4 mm
- Ø 5 mm
- Ø 6,5 mm

SO 459 01 jeu de 4



LE MEE

SP 459 02 jeu de 6

- à l'unité :
- SP 459 05 Ø 1 mm
 - SP 459 06 Ø 2 mm
 - SP 459 07 Ø 3 mm
 - SP 459 08 Ø 4 mm
 - SP 459 09 Ø 5 mm
 - SP 459 10 Ø 6 mm



SIEGLE

SP 459 03 ensemble complet
avec poire, corps de loupe et 3 spéculums



1/1 Ø 6,5 mm 1/1 Ø 7 mm 1/1 Ø 8 mm

1/2 1/2 1/2



TOYNBEE

- Ø 5,5 mm
- Ø 6,5 mm
- Ø 7,5 mm

SP 459 04 jeu de 3



SPECULUMS ORL RHINOLOGIE



1/1

DUPLAY

- SP 460 01 adulte
- SP 460 02 enfant
- SP 460 03 nourrisson

HATMANN HALL

150 mm



1/2

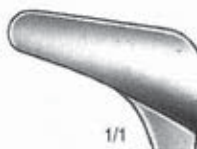

1/1

25 mm
SP 460 04

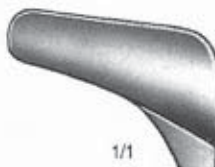

1/1

30 mm
SP 460 05

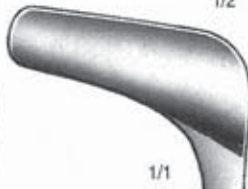

1/1

35 mm
SP 460 06



1/1

KILLIAN -130 mm



1/1

90 mm
SP 460 07



1/1

75 mm
SP 460 08



1/1

65 mm
SP 460 09



1/1

50 mm
SP 460 10

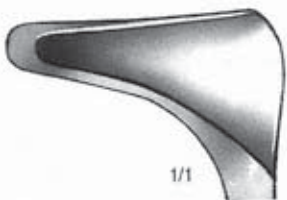

1/1

35 mm
SP 460 11



SPECULUMS ORL RHINOLOGIE

SMITH - 65 mm

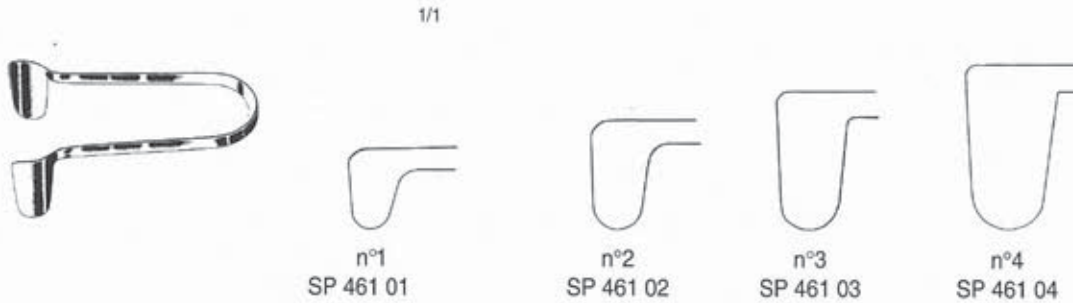

THIEC HALL - 135 mm
SP 461 05 nourrisson

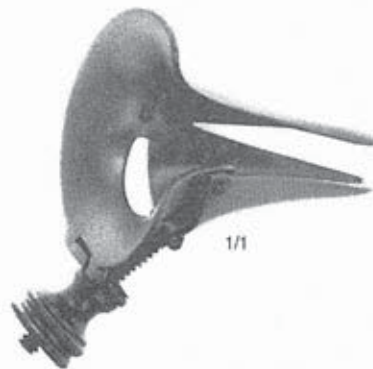

VACHER
SP 461 06 adulte
SP 461 07 enfant
SP 461 08 nourrisson

VIENNOIS - 140 mm

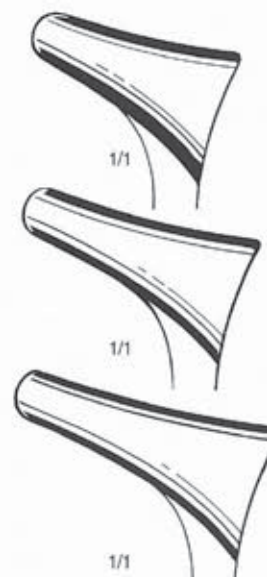

SP 461 09 nourrisson

SP 461 10 enfant

SP 461 11 adulte



BOUTONNE AVEC CHAS

ST 462 01	140 mm
ST 462 02	200 mm
ST 462 03	250 mm

1/2



BOUTONNE - DOUBLE

ST 462 04	140 mm
ST 462 05	200 mm
ST 462 06	250 mm



BOUTONNE - POINTU

ST 462 07	140 mm
ST 462 08	200 mm
ST 462 09	250 mm

1/2



PROPHIL

ST 462 10	140 mm
ST 462 11	180 mm



T - V

	PAGES
TIRE COMEDON	464
TIRE FIBROME	464
TIRE PAPILLE	464
TOURNIQUETS VASCULAIRES	465
TREPANS	467 - 469
VALVES	471 - 477
WISEUR	479



TENDEUR
 TRACTEUR DE DOYEN
 VALVES DE RICARD
 VALVES DE ROCHARD

VOIR
 VOIR
 VOIR
 VOIR

SERRE FILS
 TIRE FIBROME
 ECARTEURS ABDOMINAUX
 ECARTEURS ABDOMINAUX



TIRE COMEDON - TIRE FIBROME - TIRE PAPILLE



UNNA - tire comédon

TI 464 01 120 mm

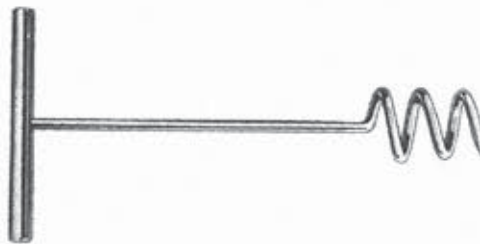

DOYEN - tire fibrome

TI 464 02



TOURNIQUETS VASCULAIRES



RUMEL ADULTE FLEXIBLE

TO 465 01 Ø 6,4 mm

TO 465 02 stylet de rechange



RUMEL ENFANT FLEXIBLE

TO 465 03 Ø 3,2 mm

TO 465 04 stylet de rechange





TREPANS

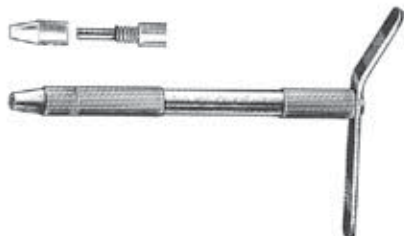

CHIRURGIE DE LA MAIN
complet avec 3 fraises

TR 467 01

DOYEN

TR 467 02 trépan seul

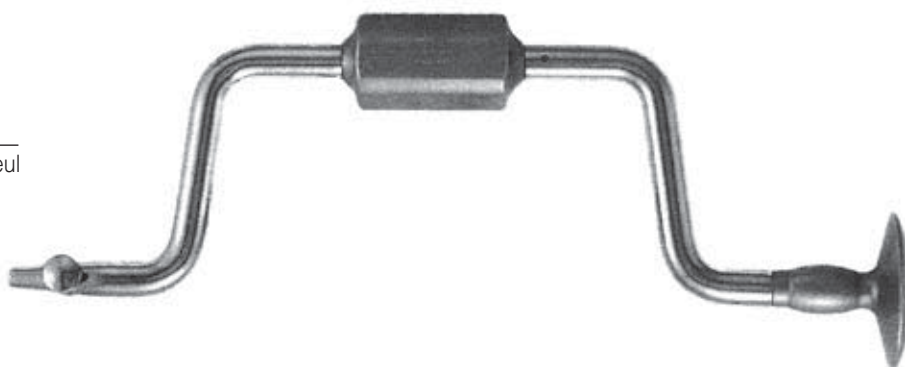

perforateur

TR 467 03 60 mm



fraise conique

TR 467 04 Ø 14 mm



fraise

TR 467 05 Ø 4 mm
TR 467 06 Ø 8 mm
TR 467 07 Ø 14 mm
TR 467 08 Ø 16 mm



couronne

TR 467 09 Ø 15 mm
TR 467 10 Ø 20 mm
TR 467 11 Ø 25 mm
TR 467 12 Ø 30 mm
TR 467 13 Ø 35 mm



TREPANS



HUDSON A ENCLIQUETAGE

trépan seul
TR 468 01



fraise

TR 468 02 Ø 9 mm

1/3



TR 468 03 Ø 14 mm

1/3



TR 468 04 Ø 16 mm

1/3



TR 468 05 Ø 22 mm

1/3

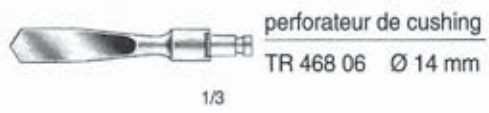

perforateur de cushing

TR 468 06 Ø 14 mm

1/3



perforateur de mac kenzie

TR 468 07 Ø 13 mm

1/3



rallonge

TR 468 08 100 mm

1/3



TREPANS

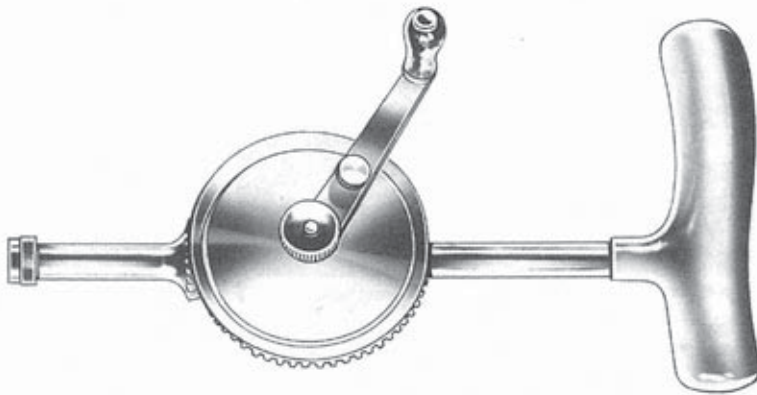

STILLE

TR 469 01 trépan seul

1/2



fraise

TR 469 02 Ø 5 mm

TR 469 03 Ø 8 mm

TR 469 04 Ø 12 mm

TR 469 05 Ø 16 mm

1/2

mèche

TR 469 06 Ø 2,5 mm

TR 469 07 Ø 3 mm

TR 469 08 Ø 3,5 mm

TR 469 09 Ø 4 mm



1/2

tréphine avec butée

TR 469 10 Ø 10 mm



1/2

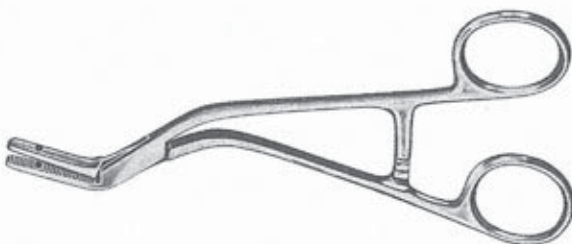

guide mèche
protège dure mère d'adson

TR 469 11



1/2

BREISKY

290 mm		320 mm	
	largeur x longueur		largeur x longueur
VA 471 01	20 x 100 mm	VA 471 06	20 x 130 mm
VA 471 02	25 x 100 mm	VA 471 07	25 x 130 mm
VA 471 03	30 x 100 mm	VA 471 08	30 x 130 mm
VA 471 04	35 x 100 mm	VA 471 09	35 x 130 mm
VA 471 05	40 x 100 mm	VA 471 10	40 x 130 mm

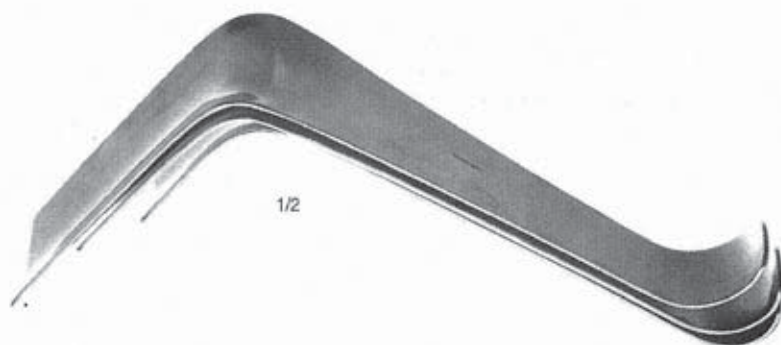

1/2

CHARRIER

VA 471 11 jeu de 3 valves largeur 40 mm
profondeur 60 mm, 90 mm et 120 mm.



VALVES



1/2

DEEVER

	largeur x profondeur
VA 472 01	20 x 180 mm
VA 472 02	25 x 200 mm
VA 472 03	25 x 280 mm
VA 472 04	37 x 300 mm
VA 472 05	50 x 300 mm

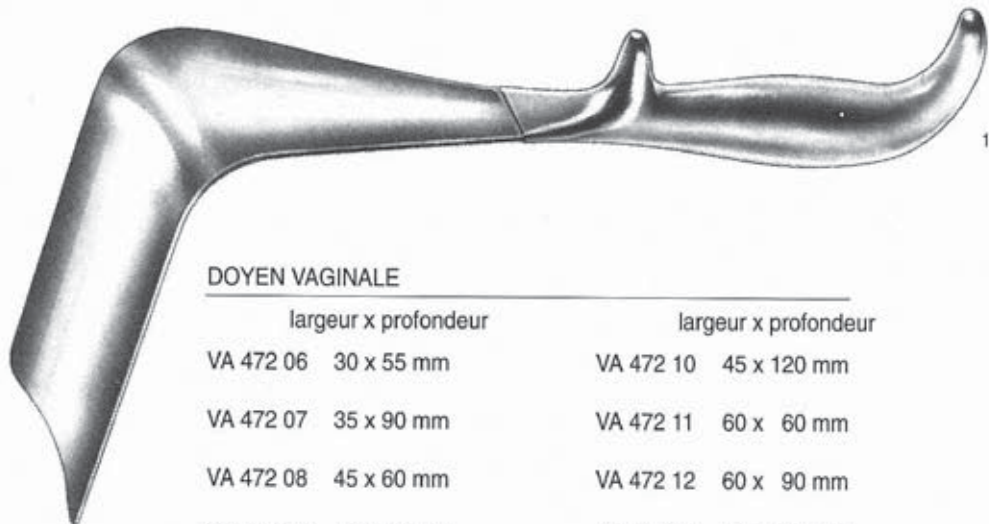

1/2

DOYEN VAGINALE

	largeur x profondeur	largeur x profondeur
VA 472 06	30 x 55 mm	VA 472 10 45 x 120 mm
VA 472 07	35 x 90 mm	VA 472 11 60 x 60 mm
VA 472 08	45 x 60 mm	VA 472 12 60 x 90 mm
VA 472 09	45 x 90 mm	VA 472 13 60 x 120 mm



1/2

HARRINGTON - 320 mm

VA 473 01 40 x 127 mm

VA 473 02 62 x 127 mm



JAYLE
valve à poids

VA 473 03 40 x 60 mm

VA 473 04 40 x 90 mm



VALVES



1/2

KOCHER
dépresseur pour la vessie
VA 474 01 60 x 240 mm



1/2

KRISTELLER Plate

VA 474 02	14 x 115 mm
VA 474 03	17 x 115 mm
VA 474 04	23 x 75 mm
VA 474 05	23 x 115 mm
VA 474 06	26 x 80 mm
VA 474 07	26 x 115 mm
VA 474 08	32 x 95 mm
VA 474 09	32 x 115 mm



1/2

KRISTELLER galbée

VA 474 10	18 x 110 mm
VA 474 11	21 x 110 mm
VA 474 12	27 x 70 mm
VA 474 13	27 x 110 mm
VA 474 14	30 x 75 mm
VA 474 15	30 x 110 mm
VA 474 16	36 x 90 mm
VA 474 17	36 x 110 mm

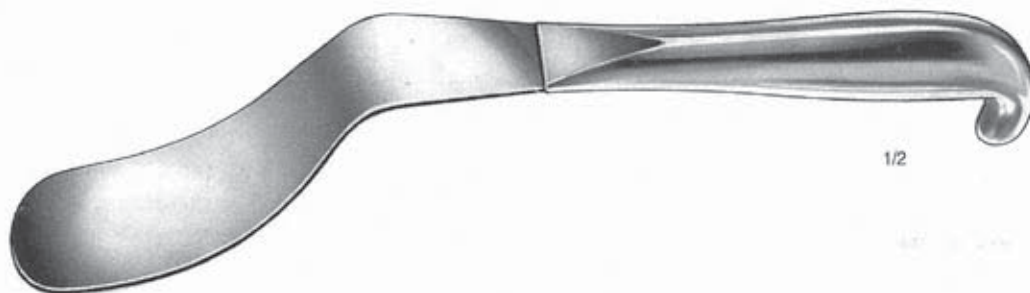

1/2

LEGUEU
dépresseur pour la vessie
VA 475 01 35 x 250 mm

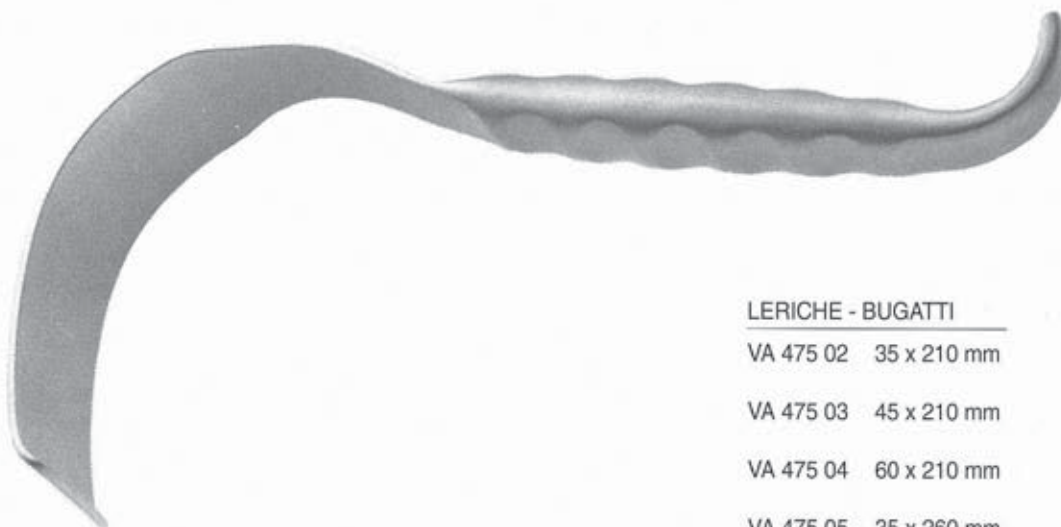

LERICHE - BUGATTI

VA 475 02 35 x 210 mm

VA 475 03 45 x 210 mm

VA 475 04 60 x 210 mm

VA 475 05 35 x 260 mm

VA 475 06 45 x 260 mm

VA 475 07 60 x 260 mm

VA 475 08 48 x 340 mm

VA 475 09 30 x 390 mm

VA 475 10 48 x 390 mm



VALVES



MANGIAGALLI
pour hystérectomie - voie basse
VA 476 01 40 x 80 mm

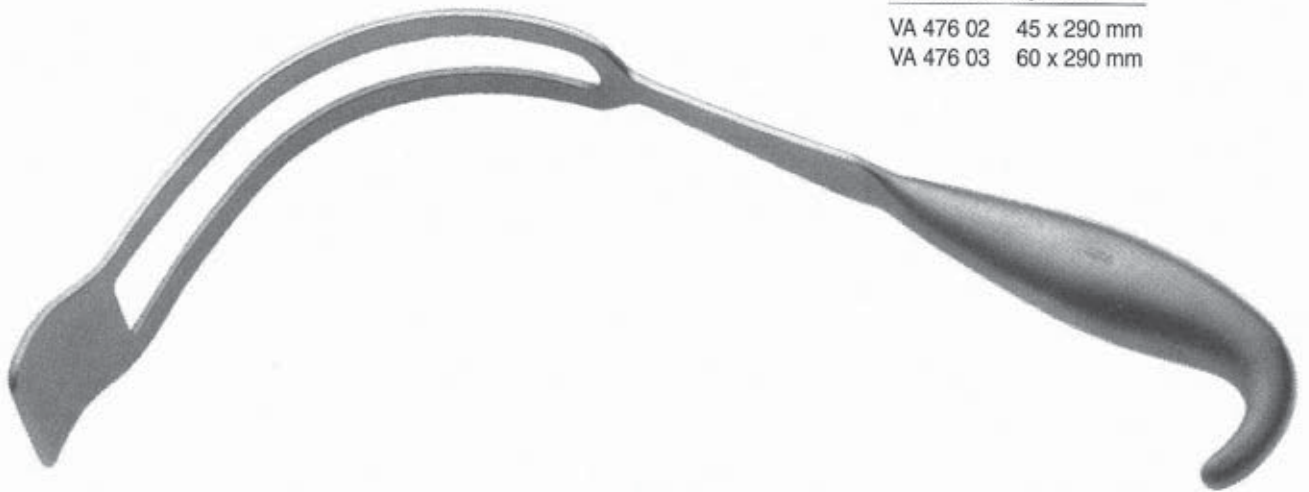

POLOSSON ajourée
VA 476 02 45 x 290 mm
VA 476 03 60 x 290 mm



POLOSSON pleine
VA 476 04 45 x 265 mm
VA 476 05 60 x 265 mm



VA

MEDLANE

VALVES

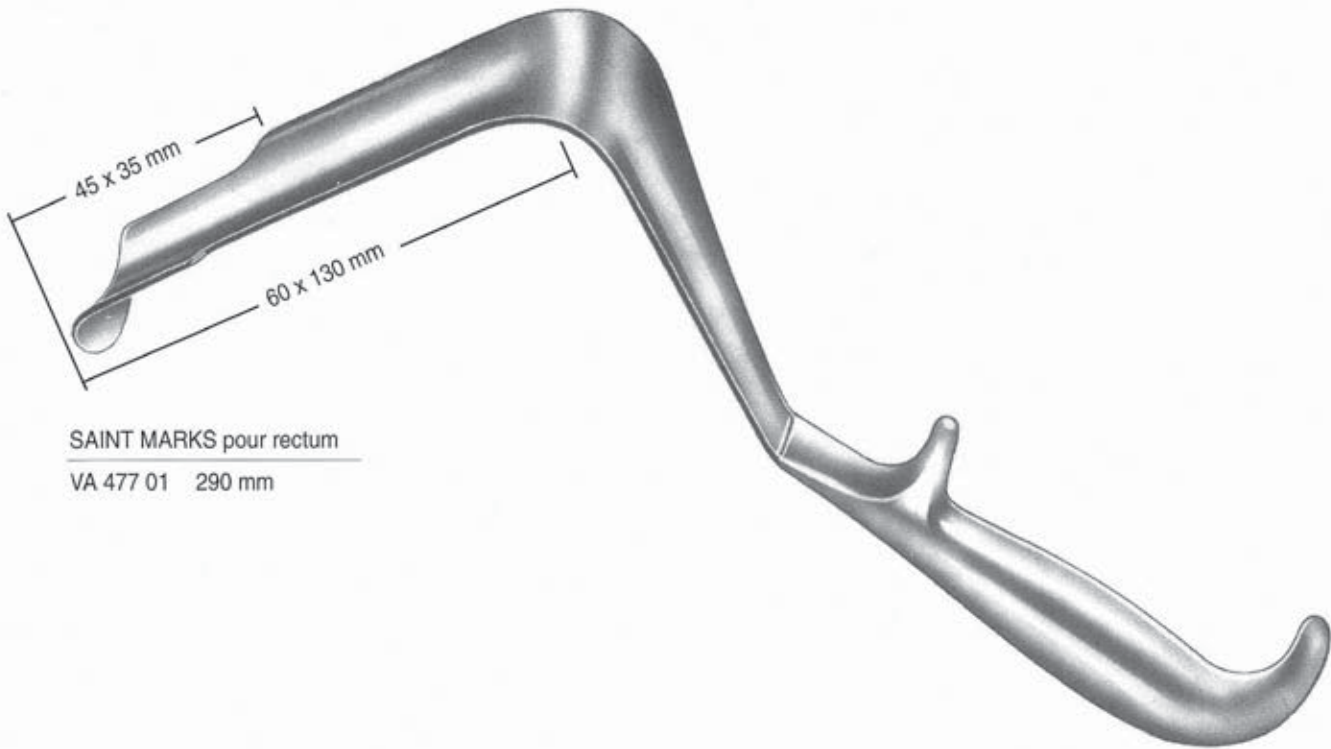

SAINT MARKS pour rectum

VA 477 01 290 mm

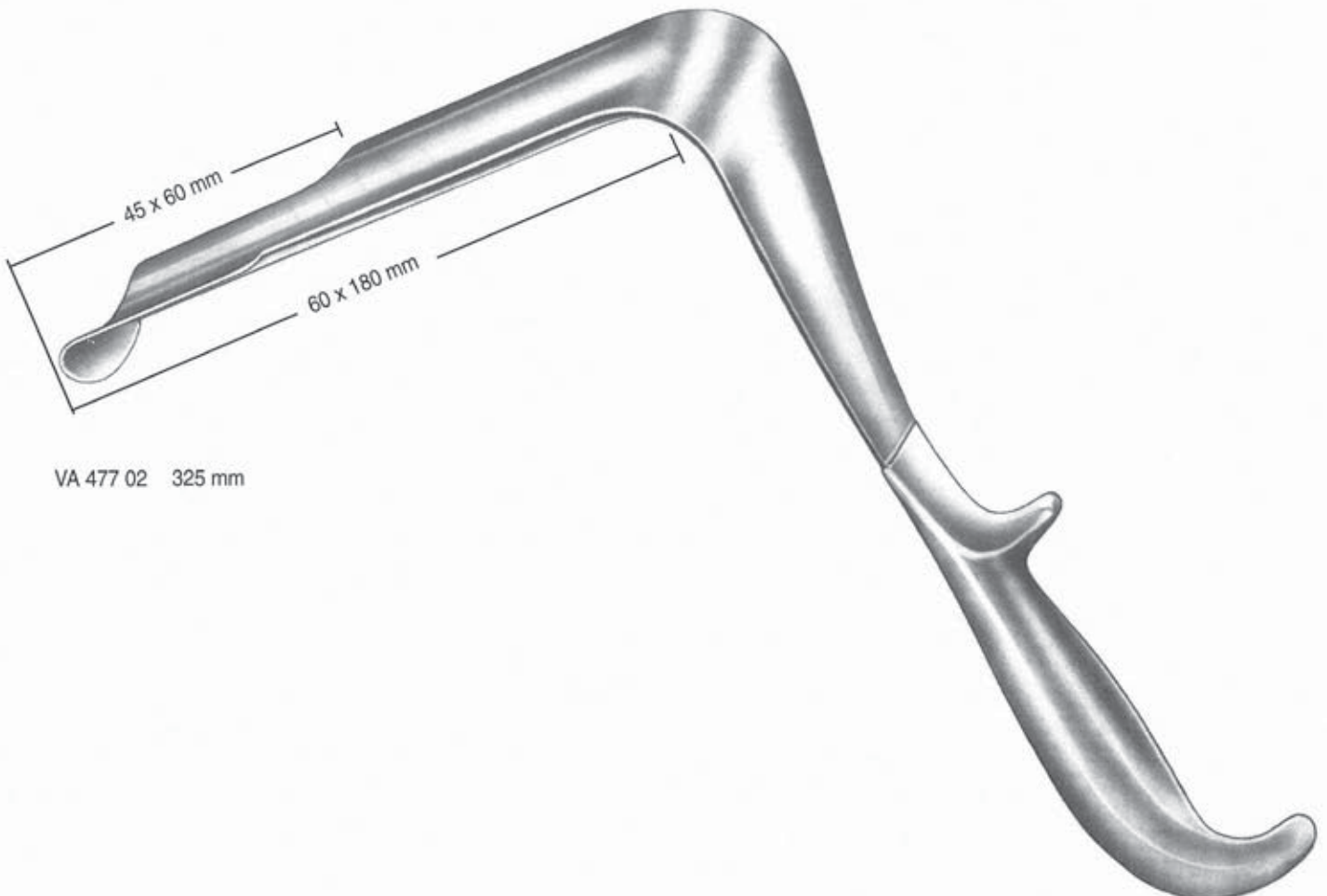

VA 477 02 325 mm



A

PAGES

ABLAZA MORSE	
RAPPROCHEURS COSTAUX	416
ADLERKREUTZ	
PINCES DISSEQUER	295
ADSON	
CANULES ASPIRATION	026
ECARTEURS AUTOSTATIQUES	218
ELEVATEURS	245
PINCES DISSEQUER	295
PINCES GOUGE SIMPLE ARTICULATION	331
ADSON BROWN	
PINCES DISSEQUER	296
ADSON GRAEFE	
PINCES DISSEQUER	296
AGRAFES	
AGRAFES MICHEL	001
MAGASIN	001
PINCES AFFRONTER	001
MARTINAUD	001
MICHEL	001
PAUCHET	001
PINCES OTER	
HEATH	002
MICHEL	002
PINCES POSER	
BRUNON HEGENBART	002
MICHEL	002
AIGUILLES	
PARACENTESE	004
POLITZER	004
SUTURES CHAS MOBILE	
REVERDIN	004-005
SUTURES PASSE FILS	
BRUNNER	010
DEMEL	011
DESCHAMPS	011
DESCHAMPS SHAUTA	010
DOYEN	011
EMMET	011
SUTURE PASSE FILS MAXILLAIRES	
OBWEGESER	012
SANDERS BROWN	012
ALENE	
ALENE DE REDON	012
ALEXANDER	
CISEAUX A OS - BURINS	067
CISEAUX A OS - GOUGES	073
ALLAINES	
CISEAUX DISSECTEURS	039
ALLIS	
PINCES PREHENSION MULTIGRIFFES	389
ALM	
ECARTEURS AUTOSTATIQUES	219
AMNIOSCOPE AVEC MANDRIN	013
AMNIOTOME	
VOIR PERCE MEMBRANE	335
AMPLIGREFFE	013
AMYGDALOTOME	
SLUDER BALLENGER	015
ANGLE DROIT	
VOIR PASSE FILS	266 - 272
ANNEAUX ENDARTERIECTOMIE	
VOLLMAR	017

ANSES AURICULAIRES

BILLAU	017
SNELLEN	017

ANUSCOPES

BENSAUDE (ADULTE/ENFANT)	017
FANSLER	018
SIMS AJOURE	018

ARRUGA

PORTE AIGUILLES	400
-----------------	-----

AUBERT

CANULES ASPIRATION	026
--------------------	-----

AUFRICTH

ECARTEUR SUR MANCHE	180
RAPES	414

B

BABCOCK

PINCES PREHENSION AJOUREES	383
----------------------------	-----

BACKAUS

PINCES CHAMPS	284
---------------	-----

BACON

PINCE GOUGES SIMPLE ARTICULATION	331
----------------------------------	-----

BAHNSON (DEBAKEY)

CLAMPS VASCULAIRES ILIAQUE	111
----------------------------	-----

BAILEY

RAPPROCHEURS COSTAUX	416
----------------------	-----

BAINBRIDGE

CLAMPS DIGESTIFS	091
CLAMPS VASCULAIRES PERIPHERIQUES	115

BAGUES

VOIR PINCES COUPANTES	292
-----------------------	-----

BAKES

DILATATEURS VOIES BILIAIRES	169
-----------------------------	-----

BALFOUR

ECARTEURS ABDOMINAUX	203
----------------------	-----

BALLENGER

CISEAUX A OS - GOUGES	073
COUTEAUX O.R.L. (RHINOPLASTIE)	136

BANCAL

CISEAUX ONGLES	057
CISEAUX PANSEMENTS - PLATRE	059

BARRAYA

PINCES DISSEQUER (VISCERALE)	296
------------------------------	-----

BARSKY

CROCHETS (A TISSUS)	139
---------------------	-----

BARTON

FORCEPS OBSTETRIQUES	250
----------------------	-----

BAUMGARTNER

PORTE AIGUILLES	397
-----------------	-----

BEACHAM

PERCE MEMBRANE	335
----------------	-----

BECK

CLAMPS VASCULAIRES ANASTOMOSE	098
-------------------------------	-----

BECKMANN

COUTEAUX O.R.L. (AMYGD.,VEGETATION)	136
ECARTEURS AUTOSTATIQUES	219

BECKMANN CONE

ECARTEURS AUTOSTATIQUES	220
-------------------------	-----

BECKMANN EATON

ECARTEURS AUTOSTATIQUES	220
-------------------------	-----



B Suite

	PAGES		
BECKMANN STILLE			
ECARTEURS AUTOSTATIQUES	220		
BEEBE			
CISEAUX FILS ACIER - LIGATURES	042		
BENGOLEA			
PINCES HEMOSTATIQUES	342 - 343		
BENNET			
ECARTEURS SUR MANCHE	180		
BENSAUDE			
ANUSCOPIES	017		
BERGER			
PINCES BIOPSIE GYNECOLOGIE	275		
BERGERET			
ECARTEURS ABDOMINAUX	204		
BERGMANN			
CROCHETS (A TRACHEE)	139		
BERRY			
PINCES FILS D'ACIER PREHENSION	323		
BESNIER			
CURETTES DERMATOLOGIE	148		
BETHUNE			
COSTOTOMES	130		
BEYER			
PINCES GOUGE DOUBLE ARTICULATION	325		
PINCES GOUGE SIMPLE ARTICULATION	331		
RONGEURS O.R.L.	427		
BILLAU			
ANSES AURICULAIRES	017		
BIRSCHER			
COUTEAUX MENISQUES	134		
PINCES MENISQUES	365		
BISTOURIS			
BRISE-LAMES	020		
MANCHE INOX	020		
SIMS	020		
BLACKE			
PINCES CALCULS	281		
BLONDIAU			
CURETTES O.R.L.	152		
BLOUNT			
ECARTEURS SUR MANCHE	180		
BLUMENTHAL			
PINCES GOUGES SIMPLE ARTICULATION	331		
BOETTCHER			
CISEAUX O.R.L. - PLASTIE	052		
BOLHER			
PINCES GOUGES DOUBLE ARTICULATION	325		
BOMMELAER			
CANULES HYSTEROGRAPHIE	028		
BONNEY			
PINCES DISSEQUER	297		
BOSE			
CROCHETS (A TRACHEE)	139		
BOUGIES DILATATEURS			
BOITES BOUGIES COMPLETES	021		
HEGAR	021		
BOSE			
CROCHETS (A TRACHEE)	139		
BOUGIES DILATATEURS			
BOITES BOUGIES COMPLETES	021		
HEGAR	021		
BOYD			
CISEAUX DISSECTEURS	039		
BOYLE DAVIS			
OUVRE-BOUCHES	260		
BOYNTON			
PORTE AIGUILLES	401		
BOZEMANN			
PINCES PANSEMENTS	376		
BRAUN STADLER			
CISEAUX GYNECO	046		
BREISKY			
VALVES GYNECO	471		
BRISE LAMES			
	020		
BROCK			
CURETTES DERMATO (GRATTOIR)	148		
BROPHY			
CISEAUX O.R.L. - PLASTIE	052		
BROSSE A ONGLES			
BROSSES	024		
DISTRIBUTEURS 20 BROSSES A ONGLES	024		
BROWN RESANO			
PINCES DISSEQUER	297		
BRUNINGS			
PINCES O.R.L. RHINOLOGIE	371		
SERRE NOEUDS	448		
BRUNNER			
AIGUILLES SUTURES PASSE FILS	010		
CLAMPS DIGESTIFS	091		
COSTOTOMES	130		
BRUNON HEGENBART			
PINCES A POSER	002		
BRUNS			
CISEAUX PANSEMENTS - PLATRE	061		
CURETTES OSSEUSES	156 - 157		
BUCK			
CURETTES O.R.L.	152		
BUGATTI (LERICHE)			
VALVES	475		
BULLDOG			
VOIR CLAMPS	086 - 089		
BUNNEL			
PERFORATEUR	274		
BURINS			
VOIR CISEAUX A OS	067 - 071		
BUSCH			
CISEAUX GYNECOLOGIE	046		

C

CADRE PORTE INSTRUMENTS			
EPINGLE PORTE PINCES	026		
LORTAT	026		
MEDLANE	026		
CADRES LAPAROTOMIE			
VOIR ECARTEURS ABDOMINAUX	203 - 217		



C Suite

	PAGES		
CANULES		CHEVRET	
ASPIRATION	026 - 027	LAMES MALLEABLES	256
ADSON	026	CHOMPRET	
AUBERT	026	CURETTES O.R.L.	152
FRAZIER	026 - 027	RUGINES (SYNDESMOTOMES)	430
POOLE	027	CHRISTOPHE	
SANTY	027	PINCES HEMOSTATIQUES	344
WERTHEIMER	027	CIRCERON	
YANKAUER	027	PINCES STERILET	335
BIOPSIE ENDO UTERINE		CISAILLES	
NOVAK	028	A PLATRE	
RANDALL	028	MODELE PUISSANT	030
HEPARINE		SEUTIN	030
BOMMELAER	028	STILLE	030
RADIOMANOMETRIE		PANSEMENTS - VETEMENTS	030
CHAMPEAU	028	CISEAUX	
LIEBOVICI	028	COURANTS	
CARMALT (ROCHESTER)		COOPER	033
PINCES HEMOSTATIQUES	359	DEMONTABLE	032
CARPENTER		ENUCLEATION	034
DISSECTEUR SUR MANCHE	171	IRIDECTOMIE	034
CASPAR		MAYO	035 - 037
RONGEUR A DISQUE INTERVETEBRAL	418	MOUSSE-MOUSSE (MEDECIN)	032
CASTANEDA		MOUSSE-POINTU (DAUPHIN)	032
CLAMPS VASCULAIRES PEDIATRIQUES	118	POINTU-POINTU	032
CASTROVIEJO		STRABISME	037
PORTE AIGUILLE MICRO	406 - 407	DISSECTEURS	
CAUCHOIX		ALLAINES	039
CISEAUX A OS - GOUGES	073	BOYD	039
CISEAUX A OS - OSTEOTOME	080	DEMARTEL	039
CHADWICK		DUBOST	040
CISEAUX O.R.L. - PLASTIE	0052	LEXER BABY	040
CHAMPEAU		METZENBAUM NELSON	041 - 042
CANULES RADIOMANOMETRIE	028	FILS ACIER - LIGATURES	
CHAPUT		BEEBE	042
PINCES PREHENSION MULTIGRIFFES	390	SPENCER	043
CHARNLEY		UNIVERSEL	043
ECARTEURS AUTOSTATIQUES	221	GYNECO	046 - 047
CHARNLEY LE PETIT		MICRO	
PINCES DISSEQUER	297	CORPS PLAT	049
CHARRIER		CORPS ROND	049
VALVES	471	O.R.L. - PLASTIE	052 - 055
CHASSE GREFFONS		ONGLES	
CYLINDRIQUES	029	BANCAL	057
TRILLAT	029	ENVIES	057
CHATELLIER		INCARNES	057
CURETTES O.R.L.	152	PERCY	057
CHAUSSE VEINE		PANSEMENTS - PLATRE	
KIENNY	029	BANCAL	059
CHERON		BRUNS	061
PINCES GYNECO	337 - 338	COUTURIERE	059
CHEVALIER JACKSON		GAZE	059
PINCES O.R.L. LARYNGOLOGIE	368 - 369	LINGERE	059
CHEVASSU		LISTER	060
CURETTES CALCULS RENAUX	147	ROUANNAIS	060
		TAILLEUR	060
		TAILLEUR PARIS	060
		UNIVERSEL	061
		VASCULAIRES	063 - 065



C Suite

	PAGES		
CISEAUX A OS			
BURINS	067 - 071		
GOUGES	073 - 077		
OSTEOTOMES	080 - 082		
CISEAUX DAUPHIN			
VOIR CISEAUX COURANTS	032		
CISEAUX MEDECIN			
VOIR CISEAUX COURANTS	032		
CLAMPS			
BULLDOG			
DEBAKEY	087		
GLOVER	088 - 089		
MICRO	086		
MODELE FIN	086		
MODELE FORT	086		
PINCE A POSER	089		
CLAMPS (SUITE)			
DIGESTIF	091 - 096		
VASCULAIRES ANASTOMOSE	098		
VASCULAIRES AORTIQUES	099 - 102		
VASCULAIRES AURICULAIRES	103		
VASCULAIRES BRONCHES	103 - 104		
VASCULAIRES BULLDOG	104 - 105		
VASCULAIRES CAROTIDES	105 - 106		
VASCULAIRES COARCTATION	106 - 110		
VASCULAIRES ILIAQUE	111		
VASCULAIRES LIGATURES-DISSECTIONS	111-112		
VASCULAIRES MULTIPOSE	112 -114		
VASCULAIRES OCCLUSION TANGENTIELLE	114		
VASCULAIRES PEDIATRIQUES	118 - 121		
VASCULAIRES PERIPHERIQUES	115 - 118		
VASCULAIRES RENALE - VEINE CAVE	121		
CLEVELAND			
PINCES GOUGE SIMPLE ARTICULATION	332		
CLIPS			
ANEVRISMES			
YASARGIL CLIPS	124 - 125		
YASARGIL PINCE A POSER CLIPS	125		
VAISSEAUX			
CUSHING CLIPS	126		
CUSHING MAGASIN DE 25 CLIPS	126		
CUSHING PINCE A POSER	126		
CLOVIS VINCENT			
CURETTES OSSEUSES	157		
DISSECTEURS SUR MANCHE	171		
PINCES COAGULER MONOPOLAIRES	288		
PINCES DISSEQUER	297		
PINCES GOUGES SIMPLE ARTICULATION	332		
SPATULES (CEREBRALES)	453		
CLOWARD			
CURETTES OSSEUSES	158		
ECARTEURS AUTOSTATIQUES	221		
ECARTEURS AUTOSTATIQUES RACHIS	230 - 233		
ECARTEURS SUR MANCHE	180 - 181		
RONGEURS A DISQUE INTERVERTEBRAL	418		
RONGEURS A LAMES VERTEBRALES	423		
COBB			
CISEAUX A OS - GOUGES	073		
RUGINES (POUR LE RACHIS)	430		
COEUR			
PINCES PREHENSION AJOUREES	384		
COLLIN			
COSTOTOMES	130		
PINCES BIOPSIE GYNECOLOGIE	275		
PINCES GYNECO (HYSTEROLABES)	335		
RUGINES	435		
SPECULUMS GYNECO	455		
CONDUCTEUR POUR SCIES EN FIL			
VOIR SCIES	443 -445		
CONE			
ECARTEURS AUTOSTATIQUES	220		
COOLEY			
CLAMPS VASCULAIRES ANASTOMOSE	098		
CLAMPS VASCULAIRES CAROTIDES	105 - 106		
CLAMPS VASCULAIRES COARCTATION	106 - 107		
CLAMPS VASCULAIRES PEDIATRIQUES	119		
CLAMPS VASCULAIRES PERIPHERIQUES	115		
CLAMPS VASCULAIRES RENALE	121		
CLAMPS VASCULAIRES VEINE CAVE	121		
ECARTEURS SUR MANCHE	181		
COOPER			
CISEAUX COURANTS	033		
COPE			
ECARTEURS DOUBLES	175		
CORYLLOS			
COSTOTOMES	130		
ECARTEURS SUR MANCHE	181		
COSTOTOMES			
BETHUNE	130 - 132		
BRUNNER	130		
COLLIN ESLANDER	130		
CORYLLOS BETHUNE	130		
GLUCK	131		
MAURER COLLIN	131		
ROOS	131		
SAUERBRUCH	131		
SAUERBRUCH FREY	132		
STILLE	132		
STILLE GIERTZ	132		
COTTE			
ECARTEURS ABDOMINAUX	205		
PINCES GYNECO (A LAMBEAUX)	335		
COTTLE			
CISEAUX O.R.L. - PLASTIE	052		
DISSECTEUR SUR MANCHE	171		
PINCES COUPANTES SIMPLE ARTICULATION	292		
RAPES	414		
COUTEAUX			
MENISQUES	134		
O.R.L.			
BALLENGER (RHINOPLASTIE)	136		
BECKMANN (AMYGDALES, VEGETATIONS)	136		
MOURE (VEGETATIONS)	137		
ST CLAIR THOMPSON (VEGETATIONS)	137		
CRABE			
PINCES CHAMPS	284		
CRAFOORD			
CISEAUX VASCULAIRES	063		
PINCES HEMOSTATIQUES	345		
CREED			
DISSECTEUR	171		
CRILE			
CROCHETS (A NERFS/VAISSEAUX)	139		
ECARTEURS DOUBLES	175		
PINCES HEMOSTATIQUES	345		



C Suite

PAGES

CRILE WOOD	
PORTE AIGUILLES	397
CROCHETS	
BASKY (TISSUS)	139
BERGMANN (A TRACHEE)	139
BOSE (A TRACHEE)	139
CRILE (A NERFS/VAISSEAUX)	139
CUSHING	140
DURE MERE	140
NERFS-VAISSEAUX	140
DANDY (A NERFS/VAISSEAUX)	140
DINGMAN (MAXILLO)	140 - 141
FRAZIER (DURE MERE)	141
GILLIES (A TISSUS)	141
GRAEFE (A TISSUS)	141
GRAHAM (A NERFS)	141
JACKSON (A TISSUS/TRACHEE)	142
JOSEPH DOUBLE (A TISSUS)	142
KLEINERT KUTZ (A TISSUS)	142
KRAYENBUHL	142
LAMBOTTE (A OS)	143
LANGE (A FISTULE)	143
SMITHWICK (DISSECTEUR A NERF)	143
TONNIS (DURE MERE)	144
TRILLAT (A MENISQUES)	144
WAGNER (A NERF/ VAISSEAUX)	144
CRUTCHFIELD	
ETRIERS	247
CUILLER	
VOIR FORCEPS	250 - 253
CURETTES	
CALCULS BILIAIRES	146 - 147
CALCULS RENAUX	147
DERMATO	148
BESNIER (PLEINE/FENETREE)	148
BROCK GRATTOIR (MOUSSE)	148
VIDAL GRATTOIR (TRANCHANT)	148
GYNECO	148 - 150
O.R.L.	152 - 154
OSSEUSES	156 - 158
CUSCO	
SPECULUMS	456
CUSHING	
CLIPS POUR VAISSEAUX	126
CROCHETS	140
ECARTEURS SUR MANCHE	182
ELEVATEURS	245
PINCES COAGULER MONOPOLAIRES	288
PINCES DISSEQUER	298
RONGEURS A DISQUE INTERVERTEBRAL	418
TREPANS	468

D

DALE	
CLAMPS VASCULAIRES PERIPHERIQUES	115 - 116
DANDY	
CROCHETS (A NERFS/ VAISSEAUX)	140
PINCES HEMOSTATIQUES	345
DANIS	
ELEVATEURS	245
PASSE-FILS	266

DARTIGUES	
PINCES GYNECO (HYSTEROLABE)	336
DAVIERS A OS	
DINGMANN	162
FARABEUF	162
KERN LANE	162
LAMBOTTE	163
LANE	162 - 163
LOWMAN	164
OLLIER	164
REDUCTEUR	164
SEMB	165
SEQUESTRE (PINCE)	165
SETTER (REDUCTEUR)	165
VERBRUGGE	165 - 166
DAVIS	
DISSECTEUR	171
ECARTEURS AUTOSTATIQUES	222
LAMES MALLEABLES	256
DAVIS BOYLE	
OUVRE-BOUCHES	260
DE RIBEROLLES	
ECARTEURS A MITRALE	239
DEAVER	
VALVES	472
DEBAKEY	
CISEAUX VASCULAIRES	063
CLAMPS BULLDOG	087
CLAMPS VASCULAIRES ANASTOMOSE	098
CLAMPS VASCULAIRES ANEURISMES	102
CLAMPS VASCULAIRES AORTIQUES	099 - 102
CLAMPS VASCULAIRES BULLDOG	104 - 105
CLAMPS VASCULAIRES CAROTIDES	105 - 106
CLAMPS VASCULAIRES COARCTATION	107 - 109
CLAMPS VASCULAIRES DISSECTION	111 - 112
CLAMPS VASCULAIRES ILIAQUE	111
CLAMPS VASCULAIRES LIGATURES	111 - 112
CLAMPS VASCULAIRES MULTIPOSE	112 - 114
CLAMPS VASCULAIRES OCCLUSION	114
CLAMPS VASCULAIRES PERIPHERIQUES	115 - 118
CLAMPS VASCULAIRES RENALE	121
CLAMPS VASCULAIRES VEINE CAVE	121
DILATATEURS VASCULAIRES	168
PINCES DISSEQUER (ATRAUMATIQUES)	299 - 300
PINCES HEMOSTATIQUES	346
PORTE AIGUILLES	397
DELABARRE	
OUVRE-BOUCHES	261
DELESTRE	
CISEAUX GYNECOLOGIE	046
DELORE	
PINCES HEMOSTATIQUES	346
DEMARTEL	
CISEAUX DISSECTEURS	039
CONDUCTEUR POUR SCIE EN FIL	443
ECRASEURS INTESTINAUX	244
PINCES COAGULER MONOPOLAIRES	288
PINCES DISSEQUER	301
PINCES HEMOSTATIQUES CUIR CHEVELU	346
DEMEL	
AIGUILLES SUTURES PASSE FILS	011
DEMELIN SUZOR	
FORCEPS OBSTETRICAUX	250
DENIS BROWN	
ECARTEURS ABDOMINAUX	207 - 208



D Suite

	PAGES		
DEPRESSEUR A VESSIE		DOUAY COLLIN	
VOIR VALVES	471 - 477	PINCES BIOPSIE GYNECOLOGIE	275
DERF		DOUGHTY	
PORTE AGUILLES	398	OUVRE BOUCHES	261
DERRA		DOUGLAS	
CLAMPS VASCULAIRES ANASTOMOSE	098	PINCES PANSEMENTS	376
DESCHAMPS		DOYEN	
AIGUILLES SUTURES PASSE FILS	011	AIGUILLES SUTURES PASSE FILS	011
DESCHAMPS SHAUTA		CISEAUX GYNECOLOGIE	046
AIGUILLES SUTURES PASSE FILS	010	CLAMPS DIGESTIFS	091 - 092
DESENCLAVEUR		OUVRE BOUCHES	261
VOIR TIRE FIBROME	464	PINCE CHAMPS (ERIGNE)	284
DESGOUTTES		RUGINES (COSTALES ADULTE/ENFANT)	431
PINCES DISSEQUER	301	TIRE FIBROME	464
DESJARDINS		TREPAN	467
CURETTES CALCULS BILIAIRES	146	VALVES (VAGINALES)	472
PINCES CALCULS	281	DRAGUES BILIAIRES	
PINCES HEMOSTATIQUES CANAL CYSTIQUE	347	VOIR CURETTES	146
DESMARRES		DUBOIS	
ECARTEURS SUR MANCHE	183	CISEAUX GYNECOLOGIE	047
DIETRICH		DUBOST	
CISEAUX VASCULAIRES	064	CISEAUX DISSECTEURS	040
CLAMPS VASCULAIRES AORTIQUES	100	ECARTEURS THORACIQUES	240
DILATATEURS		DUMONT	
TRACHEAUX	168	PINCES DISSEQUER (MICRO)	314
VASCULAIRES	168 - 169	DUPLAY	
VOIES BILIAIRES	169	SPECULUMS O.R.L. RHINOLOGIE	460
DILATATEUR DE HEGAR		DURAND	
VOIR BOUGIES	021	PINCES DISSEQUER PATTES DE VELOURS	301
DINGMAN		DUVAL	
CROCHETS (MAXILLO)	140 - 141	PINCES DISSEQUER	302
DAVIER A OS	162	PINCES PREHENSION AJOUREES	385 - 387
OUVRE-BOUCHES	260		
DISSECTEURS			
VOIR ELEVATEURS	245 - 246		
DISSECTEURS PASSE FILS			
VOIR PASSE FILS	266 - 272		
DISSECTEURS SUR MANCHE			
CARPENTER (AMYGDALES)	171		
CLOVIS VINCENT (DURE MERE)	171		
COTTLE (CLOISON)	171		
DISSECTEURS SUR MANCHE (SUITE)			
CREED (VASCULAIRE)	171		
DAVIS (DURE MERE)	171		
FRAZIER (DURE MERE)	171		
FREER (CLOISON)	172		
HOEN (DURE MERE)	172		
HURD (AMYGDALES)	172		
KILLIAN (CLOISON)	172		
LERICHE (UNIVERSEL)	173		
ROBB (VASCULAIRE)	173		
SACHS (DURE MERE)	173		
TONNIS (DURE MERE)	173		
DISTRIBUTEUR			
BROSSE A ONGLES	024		
DISTRIBUTEURS 20 BROSSES A ONGLES	024		
DOUAY			
PINCES BIOPSIE GYNECOLOGIE	275		

E

EASTMAN		EATON	
ECARTEURS DOUBLE	177	ECARTEURS AUTOSTATIQUES	220
ECARTEURS		ECARTEURS	
ABDOMINAUX		BALFOUR	203
BERGERET	204	BERGERET	204
COTTE (CESARIENNE)	205	COTTE (CESARIENNE)	205
DENIS BROWN	207 - 208	DENIS BROWN	207 - 208
GOSSET	209	GOSSET	209
HAUTEFEUILLE	210	HAUTEFEUILLE	210
HRYNTSCHAK (PROSTATECTOMIE)	211	HRYNTSCHAK (PROSTATECTOMIE)	211
JUDD-MASSON (PROSTATECTOMIE)	211	JUDD-MASSON (PROSTATECTOMIE)	211
KIRSCHNER	212	KIRSCHNER	212
LEGUEU (VESICAL)	213	LEGUEU (VESICAL)	213
MILLIN (PROSTATECTOMIE)	213	MILLIN (PROSTATECTOMIE)	213
RADIOTRANSARENTS	214	RADIOTRANSARENTS	214
RICARD	215	RICARD	215
ROCHARD	216	ROCHARD	216
TOUPET	217	TOUPET	217
AUTOSTATIQUES		AUTOSTATIQUES	
ADSON	218	ADSON	218
ADSON-BECKMANN	218	ADSON-BECKMANN	218
ALM	219	ALM	219
BECKMANN CONE	220	BECKMANN CONE	220
BECKMANN EATON	220	BECKMANN EATON	220
BECKMANN STILLE	220	BECKMANN STILLE	220
CHARNLEY (HANCHE/CADRE COMPLET)	221	CHARNLEY (HANCHE/CADRE COMPLET)	221



E Suite

	PAGES		
ECARTEURS (SUITE)			
AUTOSTATIQUES (SUITE)			
CLOWARD (A TISSUS)	221		
CLOWARD (RACHIS)	230 - 233		
DAVIS	222		
DOS D'ANE	222		
FINSEN (A GRAISSE)	222		
GELPI	223		
GELPI SELETZ	223		
HEISS	223		
HENLEY (VASCULAIRE)	224		
INGE (RACHIS)	234		
INGE MEARY (RACHIS)	234		
JANSEN	225		
JOLL (A GOITRE)	225		
KNIGHTON (RACHIS)	235		
LILLOIS (RACHIS)	233		
MAC KEE (HANCHE)	225		
MARCKAM MEYERDING (RACHIS)	235		
MATHEY (RACHIS)	235		
MAURER (RACHIS)	236		
MEYERDING (RACHIS)	236		
MISKIMON	226		
MUNRO	226		
PARKS-ALAN (RECTUM)	226		
RICHTER (GOITRE)	227		
RIGBY	227		
SCOVILLE HAVERFIELD (RACHIS)	236 - 237		
VACHER (MASTOIDIEN)	227		
WEITLANER	228		
WEITLANER WULLSTEIN	228		
DOUBLES			
COPE	175		
CRILE	175		
FARABEUF	175		
HARTMANN	175		
JACKSON (TRACHEAL)	176		
LUCKENS	176		
LUER	176		
MATHIEU	176		
PARKER	177		
RAGNELL	177		
RICHARDSON EASTMANN	177		
ROSE	177		
ROUX	178		
SENN MILLER	178		
U.S. ARMY	178		
SUR MANCHE			
AUFRICTH (NASAL)	180		
BENNETT (A OS)	180		
BLOUNT (GENOUX)	180		
CLOWARD	180 - 181		
COOLEY (POUR POSE DE VALVES)	181		
CORYLLOS (A POUMONS)	181		
CUSHING	182		
DESMARRES (PAUPIERES/VAISSEAUX)	183		
FARABEUF (MAIN)	183		
FARABEUF TRILLAT	183		
GILVERNET (A SINUS RENAL)	184		
GUILLAUME (A RACINE)	184		
HOHMANN	185 - 187		
KLAPP (A TENDONS)	188		
LANGENBECK	188 - 189		
LOVE (PAUPIERES/NERFS/VAISSEAUX)	190		
		MERLE D'AUBIGNE (A OS)	191
		MIDDELDORPF (GENOUX)	191
		OBWEGESER (MAXILLO-FACIALE)	192 - 193
		OLLIER (A OS)	194
		PAUL (MAIN)	194
		RICHARDSON (VASCULAIRE)	194
		ROLLET (MAIN)	195
		SAUERBRUCH	195
		SCHONBORN (A VAISSEAUX)	195
		SCOVILLE (A RACINE)	196
		SENN GREEN (MAIN)	196
		SMILLIE TRILLAT (GENOUX)	197
		STRANDELL STILLE	197
		TAYLOR (RACHIS LOMBAIRE)	197
		VOLKMANN	198 - 199
		ZENKER	200
		THORACIQUES	239 - 242
		ECARTEURS CEREBRAUX	
		VOIR SPATULES	453
		ECHLIN	
		PINCES GOUGES DOUBLE ARTICULATION	325
		ECRASEURS INTESTINAUX	
		DE MARTEL	244
		PINCER DE SERRAGE A LEVIER	244
		PROTEGE MORS	244
		PAYRE	244
		EDWARDS	
		PINCES COUPANTES DOUBLE ARTICULATION	291
		ELEVATEURS	
		ADSON	245
		CUSHING	245
		DANIS	245
		KEY	245
		LAMBOTTE	246
		LANGENBECK	246
		EMMET	
		AIGUILLES SUTURES PASSE FILS	011
		ENVIES	
		CISEAUX ONGLES	057
		EPINGLES PORTE INSTRUMENTS	
		VOIR CADRE PORTE INSTRUMENTS	026
		EPPENDORF	
		PINCES BIOPSIE GYNECOLOGIE	275
		ERIGNE DOYEN	
		VOIR PINCE CHAMPS	284
		ESLANDER	
		COSTOTOMES	130
		ETRIERS	
		CRUTCHFIELD (ETRIER CRANIEN)	247
		KIRSCHNER	247
		EUPHRATE PASQUE	
		PORTE AIGUILLES	398
		EVANS	
		PINCES DISSEQUER	302
		EXPLORATEURS BILIAIRES	
		VOIR CURETTES	146



F

	PAGES		
FANSLER		GARDNER	
ANUSCOPES	018	PINCES COUPANTES SIMPLE ARTICULATION	292
FARABEUF		GARRET	
CISEAUX A OS - BURINS	067	DILATATEURS VASCULAIRES	169
CISEAUX A OS - OSTEOTOME	080	GEISSENDOERFER	
DAVIER A OS	175	PASSE-FILS	271
ECARTEURS DOUBLES	183	GELPI	
ECARTEURS SUR MANCHE	431	ECARTEURS AUTOSTATIQUES	223
RUGINES	443	GELPI SELETZ	
SCIES (COMPLETE AVEC 2 LAMES)	443	ECARTEURS AUTOSTATIQUES	223
FARKAS		GERALD	
PINCES DISSEQUER	303	PINCES DISSEQUER	303
FARREL		GIERTZ	
PORTE COTON	410	COSTOTOMES	132
FATIO (MOREL)		GIGLI	
PINCES DISSEQUER	305	POIGNEE SEULE	443
FEHLAND		SCIES (EN FIL)	443
CLAMPS DIGESTIFS	092	GILLIES	
FEILCHENFELD		CROCHETS (A TISSUS)	141
PINCES ECHARDES	319	PINCES DISSEQUER	303
FERRIS SMITH		PORTE AIGUILLES CISEAUX	398 - 399
RONGEURS A DISQUE INTERVERTEBRAL	419	GILVERNET	
FILS D'ACIER		ECARTEURS SUR MANCHE	184
VOIR SERRE NOEUD	448 - 449	GLOVER	
FINOCHIETTO		CLAMPS BULLDOG	088 - 089
ECARTEURS THORACIQUES	241	CLAMPS VASCULAIRES COARCTATION	109 - 110
PORTE AIGUILLES	398	GLUCK	
FINSEN		COSTOTOMES	131
ECARTEURS AUTOSTATIQUES	222	GOLDMAN FOX	
FOERSTER		CISEAUX O.R.L. - PLASTIE	053
PINCES PANSEMENTS	376	GORNEY	
FOMON		CISEAUX O.R.L. - PLASTIE	054
CISEAUX O.R.L. - PLASTIE	053	GOSSET	
RUGINES	432	ECARTEURS ABDOMINAUX	209
FORCEPS OBSTETRICAUX	250 - 253	GOUGES	
FOSS		VOIR CISEAUX A OS	073 - 077
CLAMPS DIGESTIFS	093	GOURDET	
FRAZIER		CURETTES GYNECO	148
CANULES ASPIRATION	026 - 027	GRAEFE	
CROCHETS (A DURE MERE)	141	CROCHETS (A TISSUS)	141
DISSECTEUR SUR MANCHE	171	PINCES DISSEQUER	304
FREER		PINCES DISSEQUER (ADSON)	296
CISEAUX A OS - BURINS	067	GRAHAM	
DISSECTEUR SUR MANCHE	172	CROCHETS (A NERFS)	141
FREY		GRAY	
COSTOTOMES	132	PINCES HEMOSTATIQUES (CANAL CYSTIQUE)	347
FRIEDMANN		GREEN	
PINCES GOUGE SIMPLE ARTICULATION	333	ECARTEURS SUR MANCHE	196
FRUCHAUD		GREGOIRE	
RUGINES (COSTALES)	432	PINCES DISSEQUER	304
FRYKHOLM		PINCES PREHENSION AJOUREES	387
PINCES GOUGE DOUBLE ARTICULATION	326	GREGORY	
G		CLAMPS VASCULAIRES PERIPHERIQUES	117
GALLAHER		GROSS	
RAPES	414	PINCES PANSEMENTS	377



G Suite

	PAGES
GRUNWALD	
PINCES DISSEQUER	304
PINCES O.R.L. RHINOLOGIE	371
RONGEURS A DISQUE INTERVERTEBRAL	419
GUILLAUME	
CISEAUX A OS - GOUGES	074
ECARTEURS SUR MANCHE	184
GUNNAR	
PINCES TRAIRES LES DRAINS	317
GUYON	
PINCES HEMOSTATIQUES	347 - 348

H

HAJEK	
RONGEURS O.R.L.	427
HALL	
SPECULUMS O.R.L. RHINOLOGIE	460 - 461
HALLMANN	
PINCES PREHENSION AJOUREES	387
HALSEY	
PORTE AIGUILLES	399
HALSTEAD	
PINCES HEMOSTATIQUES	349 - 350
HARKEN	
CLAMPS VASCULAIRE AURICULAIRES	103
HARRINGTON	
PASSE-FILS	266
VALVES	473
HARTMANN	
ECARTEURS DOUBLES	175
PINCES O.R.L. - AMYGDALES	367
PINCES O.R.L. - CORPS ETRANGERS	370
PINCES O.R.L. - OTOLOGIE	370
PINCES O.R.L. - RHINOLOGIE	371
PINCES PREHENSION AJOUREES	386
SPECULUMS O.R.L. - AURICULAIRES	459
SPECULUMS O.R.L. - RHINOLOGIE	460
HAUTANT	
CISEAUX A OS - BURINS	068
CISEAUX A OS - GOUGES	074
HAUTEFEUILLE	
ECARTEURS ABDOMINAUX	210
HAYES	
CLAMPS DIGESTIFS	094
HEATH	
PINCES A OTER	002
HEGAR	
BOITES BOUGIES COMPLETES	021
BOUGIES - DILATATEURS	021
PORTE AIGUILLES	401 - 402
HEGENBART (BRUNON)	
PINCES A POSER	002
HEISS	
ECARTEURS AUTOSTATIQUES	223

HEGAR	
BOITES BOUGIES COMPLETES	021
BOUGIES - DILATATEURS	021
PORTE AIGUILLES	401 - 402
HEGENBART (BRUNON)	
PINCES A POSER	002
HEISS	
ECARTEURS AUTOSTATIQUES	223
HENLEY	
ECARTEURS AUTOSTATIQUES	224
HENNING	
PINCES PLATRE	382
HEPP	
TIRE PAPILLE	464
HOEN	
DISSECTEURS SUR MANCHE	185
HOFFMANN	
PINCES PRESSE TUBES	392
HOHMANN	
ECARTEURS SUR MANCHE	185
HONTON	
CISEAUX A OS - GOUGES	074
HORSLEY	
PINCES COUPANTES DOUBLE ARTICULATION	290
HOUSE	
CURETTES O.R.L.	152
HOWARTH	
RUGINES (MAXILLO)	432
HRYNTSCHAK	
ECARTEURS ABDOMINAUX	211
HUDSON	
TREPAN	468
HURD	
DISSECTEURS SUR MANCHE	172
HYSTEROMETRES	255

I

INGE	
ECARTEURS AUTOSTATIQUES RACHIS	234
ISELIN	
POINTES CARREES	395

J

J.L. FAURE	
PINCES BIOPSIE GYNECOLOGIE	276
PINCES DISSEQUER	305
PINCES GYNECO (ARTERE UTERINE)	336



J Suite

	PAGES
JACKSON	
CROCHETS	142
ECARTEURS DOUBLES	176
PINCES O.R.L. LARYNGOLOGIE	368 - 369
JACOBSON	
CISEAUX MICRO	050
PORTE AIGUILLES MICRO	407
JANSEN	
ECARTEURS AUTOSTATIQUES	225
PINCES GOUGES DOUBLE ARTICULATION	330
PINCES GOUGES SIMPLE ARTICULATION	332
PINCES O.R.L. RHINOLOGIE	372
JAVID	
CLAMPS VASCULAIRES CAROTIDES	106
JAYLE	
PINCES CHAMPS	284
VALVES (A POIDS)	473
JENNINGS	
OUVRE-BOUCHES	261
JOLL	
ECARTEURS AUTOSTATIQUES	225
JONES	
CLAMPS VASCULAIRES PERIPHERIQUES	118
JOSEPH	
CROCHETS (A TISSUS)	142
RUGINES	433
SCIES	444
JUDD MASSON	
ECARTEURS ABDOMINAUX	211
JUDET	
CISEAUX A OS - BURINS	068

K

KASADJIAN	
PINCES COUPANTES SIMPLE ARTICULATION	292
KAY (LAMBERT)	
CLAMPS VASCULAIRES AORTIQUES	100
KELLY	
CISEAUX O.R.L. - PLASTIE	054
PINCES HEMOSTATIQUES	351 - 352
PINCES PANSEMENTS	377
KERN	
DAVIER A OS	162
KERRISON	
VOIR RONGEURS LAMINA PUNCH	423 - 424
RONGEURS O.R.L.	428
KERSTING	
CLAMPS DIGESTIFS	094
KEVORKIAN	
CURETTES GYNECO	148
PINCES BIOPSIE GYNECOLOGIE	276

KEY

ELEVATEURS	245
PINCES COUPANTES DOUBLE ARTICULATION	290

KIELAND

FORCEPS OBSTETRICAUX	250 - 251
----------------------	-----------

KIENY

CHAUSSE VEINE	029
---------------	-----

KILLIAN

CISEAUX A OS - GOUGES	074
DISSECTEURS SUR MANCHE	172
SPECULUMS O.R.L. RHINOLOGIE	460

KILLNER

CISEAUX O.R.L. - PLASTIE	054 - 055
OUVRE-BOUCHES	261

KIRSCHNER

ECARTEURS ABDOMINAUX	212
ETRIERS	247

KLAPP

ECARTEURS SUR MANCHE	188
----------------------	-----

KLEINERT KUTZ

CROCHETS (A TISSUS)	142
---------------------	-----

KNIGHTON

ECARTEURS AUTOSTATIQUES RACHIS	235
--------------------------------	-----

KOCHER

CLAMPS DIGESTIFS	095
PINCES HEMOSTATIQUES	353 - 355
VALVES (DEPRESSEUR POUR LA VESSIE)	474

KOFFLER

RONGEURS O.R.L.	428
-----------------	-----

KOGAN

SPECULUMS GYNECO ENDO-CERVICAL	457
--------------------------------	-----

KONIG

SONDES	451 - 452
--------	-----------

KORTE

CURETTES CALCULS BILIAIRES	146
----------------------------	-----

KRAUSE

SERRE NOEUDS	448
--------------	-----

KRAYENBUHL

CROCHETS	142
----------	-----

KRISTELLER

VALVES GYNECO	474
---------------	-----

L

LABORDE

DILATATEUR TRACHEAL	168
---------------------	-----

LAHEY

PINCES HEMOSTATIQUES VOIE BILIAIRE	355
------------------------------------	-----

LAMBERT KAY

CLAMPS VASCULAIRES AORTIQUES	100
------------------------------	-----

LAMBOTTE

CISEAUX A OS - OSTEOTOME	081
CROCHETS (A OS)	143
DAVIER A OS	163
ELEVATEURS (LEVIERS)	246
RUGINES	433



L Suite

	PAGES		
LAMES MALLEABLES		LEXER	
CHEVRET	256	CISEAUX A OS - GOUGES	075
DAVIS	256	CISEAUX A OS - OSTEOTOME	081
LARDENNOIS	256	CISEAUX COURANTS	036
POIRIER	256	CISEAUX DISSECTEURS	040
LAMES OSTEOTOMES		LIEBOVICI	
VOIR CISEAUX A OS	067 - 082	CANULES RADIOMANOMETRIE	028
LANE		LILLOIS	
CLAMPS DIGESTIFS	096	ECARTEUR RACHIDIEN	233
DAVIER A OS	162 - 163	LIMA	
LANGE		CURETTES O.R.L.	153
CROCHETS (A FISTULE)	143	LINGERE	
LANGENBECK		CISEAUX PANSEMENTS - PLATRE	059
ECARTEURS SUR MANCHE	188 - 189	LISTON	
ELEVATEURS	246	PINCES COUPANTES DOUBLE ARTICULATION	290
SCIES	445	PINCES COUPANTES SIMPLE ARTICULATION	293
LARDENNOIS		LITTAUER	
LAMES MALLEABLES	256	PINCES COUPANTES SIMPLE ARTICULATION	293
LAWRENCE		LORNA	
PASSE-FILS	266	PINCES CHAMPS	285
LE MEE		LORTAT JACOB	
SPECULUMS O.R.L. AURICULAIRES	459	CADRE PORTE INSTRUMENTS	026
LEBSCHE		LOUTE	
CISEAUX A STERNUM	068	SERRE FILS	447
LEES		LOVE	
CLAMPS VASCULAIRES BRONCHES	103	ECARTEURS SUR MANCHE	190
LEGUEU		LOVE GRUNWALD	
ECARTEURS ABDOMINAUX	213	RONGEURS A DISQUE INTERVERTEBRAL	419
VALVES (DEPRESSEURS POUR LA VESSIE)	475	LOWMAN	
LEKSELL		DAVIER A OS	164
PINCES GOUGES DOUBLES ARTICULATION	326	LUC	
LELAND JONES		CURETTES O.R.L.	153
CLAMPS VASCULAIRES PERIPHERIQUES	118	LUCAE	
LEMMON		PINCES O.R.L. OTOLOGIE PANSEMENTS	370
RAPPROCHEURS COSTAUX	416	LUCAS CHAMPONNIERE	
LEMPERT		CISEAUX A OS - BURINS	069
CURETTES O.R.L.	153	LUCKENS	
PINCES GOUGES SIMPLE ARTICULATION	333	ECARTEURS DOUBLES	176
RUGINES	434	LUER	
LEPETIT (CHARNLEY)		CURETTES CALCULS BILIAIRES	146
PINCES DISSEQUER	297	ECARTEURS DOUBLES	176
LERICHE		PINCES GOUGES SIMPLE ARTICULATION	333
DISSECTEURS SUR MANCHE	173	LUER FRIEDMANN	
PINCES HEMOSTATIQUES	355 - 357	PINCES GOUGES SIMPLE ARTICULATION	333
RUGINES	434	LUER STILLE	
VALVES	475	PINCES GOUGES DOUBLE ARTICULATION	327
LETOURNEL		LUIKART	
CISEAUX A OS - BURINS	068	FORCEPS OBSTETRICAUX	251
CISEAUX A OS - GOUGES	075		
LEVIER A OS			
VOIR ELEVATEURS	245 - 246		
LEWIS			
RAPES	415		



M

	PAGES		
MAC EVEN		MATHIEU BOYNTON	
CISEAUX A OS - BURINS	069	PORTE AIGUILLES	400 - 401
MAILLETS	258	MATHIEU OLSEN	
MAC INDOE		PORTE AIGUILLES CISEAUX	400 - 401
PINCES COUPANTES DOUBLE ARTICULATION	291	MAURER	
PINCES DISSEQUER	305	COSTOTOMES	131
MAC KEE		ECARTEURS AUTOSTATIQUES RACHIS	236
ECARTEURS AUTOSTATIQUES	225	RUGINES (COSTALES)	434 - 435
MAGENDIE		MAYO	
PINCES GYNECO (HYSTEROLABE)	340	CISEAUX COURANTS	035 - 037
MAGILL		CURETTES CALCULS BILIAIRES	147
PINCES INTUBATION	317	MAYO HEGAR	
MAIER		PORTE AIGUILLES	401 - 402
PINCES PANSEMENTS	377	MAYO LEXER	
MAILLETS - MASSES		CISEAUX COURANTS	036
MAC EVEN	258	MAYO STILLE	
OMBREDANNE	258	CISEAUX COURANTS	037
MAINS DE PLOMB	258	MEARY	
MALTZ		ECARTEURS AUTOSTATIQUES RACHIS	234
RAPES	415	MEEKER	
MANDRIN (POIGNEE EN T)	258	PASSE-FILS	266
MANET		MERLE D'AUBIGNE	
CISEAUX A OS - BURINS	069	ECARTEURS SUR MANCHE	191
MANGIAGALLI		RUGINES	435
VALVES (HYSTERECTOMIE)	476	METZENBAUM	
MARCKAM MEYERDING		CISEAUX DISSECTEURS	041 - 042
ECARTEURS AUTOSTATIQUES RACHIS	236	MEYERDING	
MARQUARDT		ECARTEURS AUTOSTATIQUES RACHIS	235 - 236
PINCES GOUGES DOUBLE ARTICULATION	327	MEYHOFER	
MARTEL (POTTS)		CURETTES O.R.L.	153
CISEAUX VASCULAIRES	064 - 065	MICHEL	
MARTIN		AGRAFES	001
PINCES MENISQUES	365	MAGASIN	001
MASSES VOIR MAILLETS	258	PINCES A AFFRONTER	001
MASSON		PINCES A OTER	002
ECARTEURS ABDOMINAUX	211	PINCES A POSER	002
PORTE AIGUILLES	399	MICHON	
MATHEY		PINCES PROSTATIQUES	393
ECARTEURS AUTOSTATIQUES RACHIS	235	MIDDELDORPF	
MATHIEU		ECARTEURS SUR MANCHE	191
ECARTEURS DOUBLES	176	MIDDLETON JANSEN	
PORTE AIGUILLES	400 - 401	PINCES O.R.L. RHINOLOGIE	372
MATHIEU ARRUGA		MILLIN	
PORTE AIGUILLES	400 - 401	ECARTEURS ABDOMINAUX	213
		PINCES PROSTATIQUES	393
		PORTE AIGUILLES	404
		MIRIZZI	
		PINCES CALCULS	282
		MISKIMON	
		ECARTEURS AUTOSTATIQUES	226
		MIXTER	
		PASSE-FILS	266
		MOHORP	
		PINCES O.R.L. LARYNGOLOGIE	369



M Suite

	PAGES
MOLT	
OUVRE-BOUCHES	262
MOREL FATIO	
PINCES DISSEQUER	305
RUGINES	435
MORGAN	
PINCES BIOPSIE GYNECOLOGIE	278
MORRIS	
CLAMPS VASCULAIRES AORTIQUES	100
MORSE	
ECARTEURS THORACIQUES	242
RAPPROCHEURS COSTAUX	416
MOURE	
COUTEAUX O.R.L. (VEGETATIONS)	137
CURETTES O.R.L.	154
MOYNIHAN	
CURETTES CALCULS BILIAIRES	147
PINCES HEMOSTATIQUES	358
MUNRO	
ECARTEURS AUTOSTATIQUES	226
MURPHY	
PINCES PRESSE TUBES	392
MUSEUX	
PINCES GYNECO (TRACTION UTERINE)	336
PINCES MENISQUES	365
MUSEUX PALMER	
PINCES GYNECO (TRACTION UTERINE)	337
MYLES	
PINCES O.R.L. RHINOLOGIE	371

N

NAEGLE	
FORCEPS OBSTETRICAUX	251
NAIOKAZ	
CURETTES CALCULS BILIAIRES	147
NEFF	
COUTEAUX MENISQUES	134
NEGUS	
PINCES HEMOSTATIQUES	358
NELSON	
CISEAUX DISSECTEURS	041 -042
PINCES DISSEQUER	308
NORWOOD	
SERRE NOEUDS	449
NOVAK	
CANULES BIOPSIE ENDO-UTERINE	028

O

O'SHAUGNESSY	
PASSE-FILS	267 - 270
OBWEGESER	
ECARTEURS SUR MANCHE MAX. FACIALE	192 -193
RUGINES	436 - 437
OCHSNER	
CLAMPS VASCULAIRES AORTIQUES	101
SONDE FLEXIBLE (VOIES BILIAIRES)	452
OLDBERG	
RONGEURS A DISQUE INTERVERTEBRAL	419
OLIVECRONA	
PINCES GOUGES SIMPLE ARTICULATION	333
SPATULES (CEREBRALES)	453
OLLIER	
DAVIERS A OS	164
ECARTEURS SUR MANCHE	194
RUGINES	438
OLSEN HEGAR	
PORTE AIGUILLES CISEAUX	402
OMBREDANNE	
CISEAUX A OS - BURINS	069
MASSES	258
PINCES PREHENSION MULTIGRIFFES	390
POINTES CARREES	395
OSTEOTOMES	
VOIR CISEAUX A OS	080 - 082
OUVRE-BOUCHES	260 - 263
OVERHOLT GEISSENDOERFER	
PASSE-FILS	271
P	
PAJOT	
FORCEPS OBSTETRICAUX	251
PALMER	
PINCES GYNECO (A POLYPES)	337
PARKER	
ECARTEURS DOUBLES	177
PARKS -ALAN	
ECARTEURS AUTOSTATIQUES RECTUM	251
PARTSCH	
CISEAUX A OS - BURINS	069
CISEAUX A OS - GOUGES	075
PASQUE (EUPHRATE)	
PORTE AIGUILLES	398



P Suite

	PAGES		
PASSE-FILS		PINCES	
DANIS	266	BIOPSIE	
HARRINGTON	266	GYNECOLOGIE	275 - 278
LAWRENCE	266	RECTALES YEOMAN	279
MEEKER	266	CALCULS	281 - 282
MIXTER	266	CHAMPS	284 -285
O'SHAUGNESSY	267 - 270	COAGULER	
OVERHOLT GEISSENDOERFER	271	BIPOLAIRES	287
RUMEL	272	MONOPOLAIRES CLOVIS VINCENT	288
SEMB	272	MONOPOLAIRES CUSHING	288
		MONOPOLAIRES DEMARTEL	288
PASSE-LACS		COUPANTES	
VOIR TOURNIQUETS	465	DOUBLE ARTICULATION	290 - 291
		SIMPLE ARTICULATION	292 - 293
PAUCHET		DISSEQUER	
AGRAFES - PINCES A AFFRONTER	001	MICRO	313 - 314
PINCES CHAMPS	285	OPHTALMO	305 - 306
SEMELLE	447	STANDARD DELICATE	309
		STANDARD NORMALE	309 - 310
PAUL		DIVERSES	
ECARTEURS SUR MANCHE	194	DECAPSULER	317
		GUNNAR (POUR VIDER LES DRAINS)	317
PAUWELS		MAGILL (INTUBATION)	317
CISEAUX A OS - BURINS	070	ECHARDES	319
		ENVIES	319
PAYRE		EPILER	319
ECRASEURS INTESTINAUX	244	FILS ACIER	
		COUPE-FILS ET BROCHES	321
PEAN		EXTRACTION	322
PINCES PANSEMENTS	379	PREHENSION	323
		GOUGES DOUBLE ARTICULATION	325 - 330
PEERS		GOUGES SIMPLE ARTICULATION	331 - 333
PINCES CHAMPS	285	GYNECO	
		BEACHAM (PERCE MEMBRANE)	335
PELKMANN		CIRCERON (PREHENSION DU STERILET)	335
PINCES PANSEMENTS	380	COLLIN (HYSTEROLABE)	335
		COTTE (PINCE A LAMBEAUX)	335
PERCE MEMBRANE		DARTIGUES (HYSTEROLABES)	336
VOIR PINCES GYNECOLOGIE	335	J.L. FAURE (ARTERE UTERINE)	336
		MUSEUX (TRACTION UTERINE)	336
PERCY		MUSEUX PALMER	337
CISEAUX ONGLES	057	PALMER (PINCES A POLYPES)	337
SCIES (RETRACTEUR A AMPUTATION)	445	PHANEUF (ARTERE UTERINE)	337
		POZZI (TRACT. UTERINE/DEMONTABLE)	338
PERFORATEURS		POZZI PALMER (TRACTION UTERINE)	338
BUNNEL	274	ROCHARD (ARTERE UTERINE)	339
MAIN : VOIR TREPANS	467	ROGERS (ATRAUMA. ARTERE UTERINE)	339
RALK	274	SCHROEDER (TRACTION UTERINE)	339
UNIVERSEL	274	SHIRODKA MAGENDIE (HYSTEROLABE)	340
		SKENE (TRACTION UTERINE)	340
PERRY		WERTHEIM (ARTERE UTERINE)	340
PINCES DISSEQUER	306	HEMOSTATIQUES	342 - 362
		MENISQUES	365
PERTUISET		O.R.L.	
RONGEURS A DISQUE INTERVERTEBRAL	420	AMYGDALES	367
		LARYNGOLOGIE	368 - 369
PETERSEN		OTOLOGIE	370
CISEAUX A OS - GOUGES	077	RHINOLOGIE	371 - 373
PINCES GOUGES DOUBLE ARTICULATION	329	ONGLES	366
		PANSEMENTS	376 - 380
PHANEUF		LONGUETTE OU UTERINS	378 - 379
PINCES GYNECO (ARTERE UTERINE)	337	PLATRE	382
		PREHENSION	
PINCES A TRAIRES		AJOUREES	383 - 387
VOIR PINCES DIVERSES	317	MULTIGRIFFES	389 - 390
		PRESSE TUBES	
		HOFFMANN	392
		MURPHY	392
		POUR GROS TUBES	392
		WEISS	392
		PROSTATIQUES	393



P Suite

	PAGES
PINCES AGRAFES VOIR AGRAFES	001 - 002
PINCES CLAMPS VOIR CLAMPS	086 - 121
PINCES COUPE FILS D'ACIER VOIR PINCES FILS D'ACIER	321 - 323
PINCES DECAPSULER VOIR PINCES DIVERSES	317
PINCES DISQUES VOIR RONGEURS	418 - 428
PINCES INTUBATION VOIR PINCES DIVERSES	317
PINCES LONGUETTES VOIR PINCES PANSEMENTS	376 - 380
PINCES PANSEMENTS D'OREILLES VOIR PINCES O.R.L.	367 - 373
PINCES PANSEMENTS UTERINS VOIR PINCES PANSEMENTS LONGUETTE	378 - 379
PINCES TIRE BROCHES VOIR PINCES FILS D'ACIER	321 - 323
POIGNEES EN "T" VOIR MANDRIN	258
POINTES CARREES	395
POIRIER CISEAUX A OS - BURINS CISEAUX A OS - GOUGES LAMES MALLEABLES	070 076 256
POLITZER AIGUILLES PARACENTESE PINCES O.R.L. OTOLOGIE PANSEMENTS	004 370
POLOSSON VALVES (AJOUREES/PLEINES)	476
POOLE CANULES ASPIRATION	027
PORTE AIGUILLES	397 - 408
PORTE AIGUILLES CISEAUX	398 - 402
PORTE COTON FARRELL	410
PORTE INSTRUMENTS VOIR CADRE PORTE INSTRUMENTS	026
PORTMANN CISEAUX A OS - BURINS	070

POSTEL CISEAUX A OS - GOUGES SCIES	076 445
POTTS MARTEL CISEAUX VASCULAIRES	064
POTTS SMITH PINCES DISSEQUER	307
POZZI PINCES GYNECO	338
POZZI PALMER PINCES GYNECO	338
PRATT SMITH PINCES HEMOSTATIQUES	359
PRECELLE PINCES DISSEQUER	307
PRESSE-TUBES VOIR PINCES PRESSE-TUBES	392
PRICE THOMAS CLAMPS VASCULAIRES BRONCHES	104
PROPHIL STYLETS	462
PROTEZA MORSE ECARTEURS THORACIQUES	242
PROVIDENCE HOSPITAL PINCES HEMOSTATIQUES	359
PUTTI CISEAUX A OS - GOUGES RAPES	076 415
Q	
QUENU PINCES DISSEQUER	308
R	
RAGNELL CISEAUX O.R.L. - PLASTIE ECARTEURS DOUBLES	054 177
RALK PERFORATEUR	274
RANDALL CANULES BIOPSIE ENDO-UTERINE	028
RANKIN PINCES HEMOSTATIQUES	352
RAPES	414 - 415
RAPPROCHEURS COSTAUX	416



S

	PAGES		
SACHS			
DISSECTEUR SUR MANCHE	173		
SAINT CLAIR (THOMPSON)			
COUTEAUX O.R.L. (VEGETATIONS)	137		
SAINT MARKS			
VALVES (POUR RECTUM)	477		
SANDERS BROWN			
SUTURES PASSE FILS MAXILLAIRES	012		
SANTY			
CANULES ASPIRATION	027		
PINCES HEMOSTATIQUES	360 - 361		
SAROT			
CLAMPS VASCULAIRES BRONCHES	104		
PINCES HEMOSTATIQUES	361		
PORTE AIGUILLES	403		
SATINSKY			
CISEAUX VASCULAIRES	065		
CLAMPS VASCULAIRES OCCLUSION	114		
SAUERBRUCH			
COSTOTOMES	131 - 132		
PINCES GOUGES DOUBLE ARTICULATION	328		
SCHLESINGER			
RONGEURS A DISQUE INTERVERTEBRAL	420		
SCHMEDEN			
PINCES O.R.L. AMYGDALES	367		
SCHONBORN			
ECARTEURS SUR MANCHE	195		
SCHROEDER			
CURETTES GYNECO	149		
PINCES GYNECO (TRACTION UTERINE)	339		
SCHUMACHER			
CISEAUX GYNECOLOGIE	047		
PINCES BIOPSIE GYNECOLOGIE	277		
SCIES			
DEMARTEL (CONDUCTEUR SCIE EN FIL)	443		
DOS MOBILE	443		
FARABEUF (COMPLETE AVEC 2 LAMES)	443		
GIGLI (EN FIL/POIGNEE SEULE)	443		
JOSEPH	444		
LANGENBECK	445		
POSTEL	445		
SCOVILLE			
ECARTEURS SUR MANCHE	196		
SCOVILLE HAVERFIELD			
ECARTEURS AUTOSTATIQUES RACHIS	236 - 237		
SCUDER			
CLAMPS DIGESTIFS	096		
SEBILEAU			
CURETTES O.R.L.	154		
RUGINES	438		
SEEMANN SEIFERT			
OUVRE-BOUCHES	262		
SELETZ			
ECARTEURS AUTOSTATIQUES	223		
SELLHEIM			
FORCEPS OBSTETRICAUX	252		
SELLORS			
RAPPROCHEURS COSTAUX	418		
SELVERSTONE			
RONGEURS A DISQUE INTERVERTEBRAL	421		
SEMB			
CLAMPS VASC. LIGATURES-DISSECTIONS	112		
DAVIER A OS	165		
PASSE-FILS	272		
RUGINES (COSTALES)	439		
SEMELLE			
	447		
SEMKIN			
PINCES DISSEQUER	308		
SENN GREEN			
ECARTEURS SUR MANCHE	196		
SENN MILLER			
ECARTEURS DOUBLES	178		
SEQUESTRE			
DAVIER A OS	165		
SERRE FILS			
	447		
SERRE NOEUDS			
	448 - 449		
SETTER			
DAVIER A OS	165		
SEUTIN			
CISAILLES A PLATRES	030		
SHIRODKA MAGENDIE			
PINCES GYNECO (HYSTEROLABES)	340		
SIEGLE			
SPECULUMS O.R.L. AURICULAIRE	459		
SIMON			
CURETTES GYNECO	150		
SIMPSON			
FORCEPS OBSTETRICAUX	252		
SIMS			
ANUSCOPES	018		
BISTOURIS	020		
CISEAUX GYNECOLOGIE	047		
CURETTES GYNECO	150		
HYSTEROMETRES	255		
SKENE			
PINCES GYNECO (TRACTION UTERINE)	340		



S Suite

	PAGES		
SLUDER BALLENGER			
AMYGDALOTOMES	015		
SMILLIE			
COUTEAUX MENISQUES	134		
ECARTEURS SUR MANCHE	197		
VISEUR SMILLIE TRILLAT	479		
SMITH			
CISEAUX A OS GOUGES	077		
PINCES DISSEQUER	307		
PINCES GOUGES DOUBLE ARTICULATION	329		
PINCES HEMOSTATIQUES	359		
RONGEURS A DISQUE INTERVERTEBRAL	419		
SPECULUMS O.R.L. RHINOLOGIE	461		
SMITHWICK			
CROCHETS (DISSECTEURS)	143		
SNELLEN			
ANSES AURICULAIRES	017		
SONDES			
BOUTONNEE	451		
CANNELEE	451		
CANNELEE BOUTONNEE	451		
KONIG	451 - 452		
OCHSNER (FLEXIBLES VOIES BILIAIRES)	452		
SPATULES			
CLOVIS VINCENT (CEREBRALES)	453		
OLIVECRONA (CEREBRALES)	453		
SPECULUMS			
GYNECO	455 - 457		
O.R.L. AURICULAIRES	459 - 460		
O.R.L. RHINOLOGIE	460 - 461		
SPENCER			
CISEAUX LIGATURES	044		
SPENCER WELLS			
PINCES HEMOSTATIQUES	361		
SPURLING			
RONGEURS A DISQUE INTERVERTEBRAL	421		
ST CLAIR (THOMPSON)			
COUTEAUX O.R.L. (VEGETATIONS)	137		
ST MARKS			
VALVES (POUR RECTUM)	477		
STAGNARA			
CISEAUX A OS - GOUGES	077		
STEVENS			
CISEAUX O.R.L. - PLASTIE	055		
STIEGLITZ			
PINCES ECHARDES	319		
STILLE			
CISAILLES A PLATRES	030		
CISEAUX A OS - BURINS	071		
CISEAUX A OS - GOUGES	077		
CISEAUX A OS - OSTEOTOME	082		
CISEAUX COURANTS	037		
		STILLE (suite)	
		COSTOTOMES	132
		ECARTEURS AUTOSTATIQUES	220
		ECARTEURS SUR MANCHE	197
		PINCES GOUGES DOUBLE ARTICULATION	327 - 330
		PINCES HEMOSTATIQUES	362
		TREPAN	469
		STRANDELL STILLE	
		ECARTEURS SUR MANCHE	197
		STRASBOURG	
		PINCES DISSEQUER	310
		STRATTE	
		PORTE AIGUILLES	404
		STRIPPER	
		VOIR ANNEAUX	017
		STRUYKEN	
		PINCES O.R.L. RHINOLOGIE	371 - 373
		STYLETS	462
		SUBRAMANIAN	
		CLAMPS VASCULAIRES AORTIQUES	101
		SUZOR	
		FORCEPS OBSTETRIKAUX	250
		SYNDESMOTOMES	
		VOIR RUGINES	
		T	
		TAKAHASHI	
		PINCES O.R.L. RHINOLOGIE	373
		TARNIER	
		FORCEPS OBSTETRIKAUX	252
		TAYLOR	
		ECARTEURS SUR MANCHE	197
		TEISSIER	
		FORCEPS OBSTETRIKAUX	253
		TENDEUR	
		VOIR SERRE FILS	447
		TERRIER	
		OUVRE-BOUCHES	263
		PINCES HEMOSTATIQUES	362
		THIEC HALL	
		SPECULUMS O.R.L. RHINOLOGIE	461
		THIERRY	
		FORCEPS OBSTETRIKAUX	253
		THOMPSON (ST CLAIR)	
		COUTEAUX O.R.L. (VEGETATIONS)	
		THOREK	
		CISEAUX VASCULAIRES	065
		TICKNER	
		PINCES DISSEQUER	310
		TIRE COMEDON	464



T Suite

PAGES

TIRE FIBROME	
DOYEN	464
TIRE PAPILLE	
HEPP	464
TISCHLER	
PINCES BIOPSIE GYNECOLOGIE	277 - 278
TISSERAND	
PINCES CHAMPS	285
TONNIS	
CROCHETS (A DURE MERE)	144
DISSECTEUR SUR MANCHE	173
TOUPET	
ECARTEURS ABDOMINAUX	217
TOURNIQUETS VASCULAIRES	
RUMEL	465
TOYNBEE	
SPECULUMS O.R.L. AURICULAIRES	459
TRACTEUR DE DOYEN	
VOIR TIRE FIBROME	464
TREPANS	
ADSON (GUIDE MECHE)	469
CHIRURGIE DE LA MAIN	467
DOYEN	467
HUDSON	468
STILLE	469
TRICOISE	
VOIR PINCES COUPANTES	293
TRILLAT	
CHASSE GREFFONS	029
CISEAUX A OS - GOUGES	076
COUTEAUX MENISQUES	134
CROCHETS (A MENISQUES)	144
ECARTEURS SUR MANCHE	183
POINTES CARREES	395
RUGINES	440
TROUSSEAU	
DILATATEURS TRACHEAL	168
TUDOR EDWARDS	
PINCES COUPANTES DOUBLE ARTICULATION	291
TUFFIER	
ECARTEURS THORACIQUES	242
PINCES PREHENSION MULTIGRIFFES	390
TUTTLE	
PINCES DISSEQUER	311
ULRICH	
PINCES PANSEMENTS	380
UNNA	
TIRE COMEDON	464

V

VACHER

ECARTEURS AUTOSTATIQUES	227
SERRE NOEUDS	449
SPECULUMS O.R.L. RHINOLOGIE	461

VALLEIX

HYSTEROMETRES	255
---------------	-----

VALVES

BREISKY	471
CHARRIER	471
DEAVER	472
DOYEN (VAGINALES)	472
HARRINGTON	473
JAYLE (A POIDS)	473
KOCHER (DEPRESSEUR A VESSIE)	474
KRISTELLER	474
LEGUEU (DEPRESSEUR VESSIE)	475
LERICHE BUGATTI	475
MANGIAGALLI (HYSTERECTOMIE)	476
POLOSSON	476
SAINT MARKS (POUR RECTUM)	477

VALVES DE RICARD

VOIR ECARTEURS ABDOMINAUX	215
---------------------------	-----

VALVES DE ROCHARD

VOIR ECARTEURS ABDOMINAUX	216
---------------------------	-----

VELPEAU

PINCES COUPANTES SIMPLE ARTICULATION	293
--------------------------------------	-----

VERBRUGGE

DAVIER A OS	165 - 166
-------------	-----------

VIDAL

CURETTES DERMATO (GRATTOIR)	148
-----------------------------	-----

VIENNOIS

SPECULUMS O.R.L. RHINOLOGIE	461
-----------------------------	-----

VINCENT

CURETTES OSSEUSES	157
DISSECTEUR SUR MANCHE	171
PINCES COAGULER MONOPOLAIRES	288
PINCES DISSEQUER	297
PINCES GOUGES SIMPLE ARTICULATION	332
SPATULES (CEREBRALES)	453

VOLKMANN

CURETTES OSSEUSES	158
ECARTEURS SUR MANCHE	198 - 199

VOLLMAR

ANNEAUX ENDARTERIECTOMIE	017
--------------------------	-----

VOSS

SERRE NOEUDS	448
--------------	-----

U



W

WAGNER	
CROCHETS (A NERF/VAISSEaux)	144
WALLICH	
CURETTES GYNeco	150
WALTER	
PINces ECHARDES	319
PINces PREHENSION AJOUReES	387
WANGENSTEEN	
PINces DISSEQUER	311
WEBER	
CLAMPS VASCUlAIRES AORTIQUES	101
WEBSTER	
PORTE AIGUILLES	404
WEISS	
PINces PRESSE TUBES	392
WEITLANER	
ECARTEURS AUTOSTATIQUES	228
WELLS	
PINces HEMOSTATIQUES	361
WERTHEIM	
PINces GYNeco (ARTERE UTERINE)	340
WERTHEIMER	
CANULES ASPIRATION	027
WHITEHEAD	
OUVRE-BOUCHES	263
WILDE	
PINces O.R.L. RHINOLOGIE	373
WILLIAMS	
PINces PREHENSION AJOUReES	387
WILLIGER	
CURETTES OSSEUSES	158
RUGINES	440
WOLF	
PINces PLATRE	382
WOOD	
PORTE AIGUILLES	397
WULLSTEIN (WEITLANER)	
ECARTEURS AUTOSTATIQUES	228

PAGES

Y

YANKAUER	
CANULES ASPIRATION	027
YASARGIL	
CISEAUX MICRO	050
CLIPS	124 - 125
PINCE A POSER CLIPS	125
PINces DISSEQUER MICRO	315
PORTE AIGUILLES MICRO	408
RUGINES	440
YEOMAN	
PINces BIOPSIE RECTALES	279
YOUNG MILLIN	
PORTE AIGUILLES PROSTATECTOMIE	404

Z

ZAUFAL JANSEN	
PINces GOUGES DOUBLE ARTICULATION	330
ZENKER	
ECARTEURS SUR MANCHE	200
ZIELKE	
CISEAUX A OS - GOUGES	077

