



confidence in

**nopa**<sup>®</sup> instruments

more than

**30**  
**YEARS**

thank you for choosing

**nopa**<sup>®</sup> instruments

...you obviously have good taste



Dies ist unser Hauptkatalog, er bleibt unser ausschließliches Eigentum. Es gelten unsere allgemeinen Lieferbedingungen. Sie finden diese auf unserer Internetseite: [www.nopa-instruments.com](http://www.nopa-instruments.com).

This is our General Catalogue. It remains our exclusive property. Please find our "General Terms of Sale" on our corporate website: [www.nopa-instruments.com](http://www.nopa-instruments.com).

Esto es nuestro catálogo y queda nuestra propiedad. Nuestros condiciones generales de venta se encuentran en nuestra página web: [www.nopa-instruments.com](http://www.nopa-instruments.com).

Voilà notre catalogue et il demeure notre propriété. Veuillez consulter nos conditions générales de vente sur notre page Internet : [www.nopa-instruments.com](http://www.nopa-instruments.com).

Questo è nostro catalogo e rimane nostra proprietà. Trovano applicazione le nostre condizioni generali di fornitura, che sono disponibili sul nostro sito: [www.nopa-instruments.com](http://www.nopa-instruments.com).

Modelländerungen vorbehalten. Nachdruck, auch auszugsweise, verboten.  
Change of design and pattern reserved. Re-printing, even in extracts, not permitted.  
Nos reservamos el derecho de modificaciones sin aviso previo. Reimpresión, también parcialmente, está prohibido.  
Tous droits réservés aux changements de modèle. Réimprimer, également partiellement, est interdit.  
Noi riserviamo il diritto di effettuare delle modificazioni. Ristampa di divieto anche parziale.

Printed in Germany 131207



Bitte fordern Sie unsere  
entsprechenden Kataloge an.

Please request for our  
appropriate catalogues.

Por favor pidan por nuestros  
catálogos apropiados.

Veillez demander nos  
catalogues appropriés.

Chieda prego i nostri  
cataloghi adatti.

**>> Unser Lieferprogramm**

Allgemeinchirurgie und Gynäkologie  
Plastische Chirurgie und HNO  
Cardiovascular  
Neurochirurgie  
Ophthalmologie  
Endoskopie  
Behältnisse zur Instrumentensterilisation  
Dental und Oral

**>> Our product range**

General Surgery and Gynecology  
Plastic Surgery and ENT  
Cardiovascular  
Neurosurgery  
Ophthalmology  
Endoscopy  
Sterilizing Containers  
Dental and Oral

**>> Nuestro gama  
de productos**

Cirugía generales y Ginecología  
Cirugía plástica y ORL  
Cardiovasculares  
Neurocirugía  
Oftalmología  
Endoscópico  
Cajas para esterilización  
Odontología y Oral

**>> Notre gamme**

Chirurgie générale et Gynecologie  
Chirurgie plastique et ORL  
Cardiovasculaires  
Neurochirurgie  
Ophtalmologie  
Endoscopie  
Des boîtes à instruments et pour la stérilisation  
Dental et Oral

**>> Nostro programma  
di produzione**

Chirurgia generale e Ginecologia  
Chirurgia plastica ed ORL  
Cardiovasculari  
Neurochirurgia  
Oftalmologia  
Endoscopia  
Astucci per la sterilizzazione  
Odontoiatria e Orale

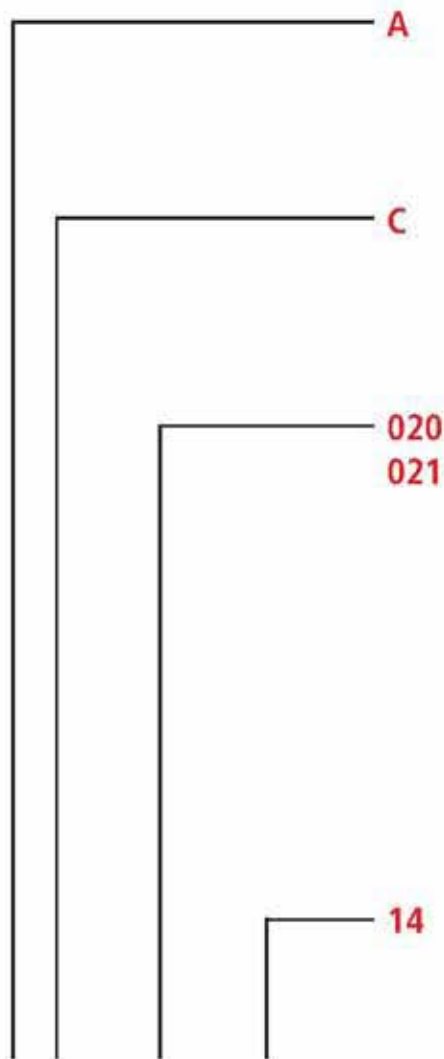

Artikelcode **AC 020/14**

**Allgemeines Instrumentarium**

General Instruments  
Instrumental Général  
Instruments Générales  
Strumenti generali

**Scheren**

Scissors  
Tijeras  
Ciseaux  
Forbici

**Fortlaufende Nummern**

Gerade Ziffer = gerades Instrument  
Ungerade Ziffer = gebogenes Instrument

**Continuous number**

Even number = straight instrument  
Odd number = curved instrument

**Número de orden**

números pares = instrumento derecho  
números impares = instrumento curvado

**Numéros d'ordre**

numéro pair = instrument droit  
numéro impair = instrument courbe

**Numeri progressivamente**

numero pari = strumento retto  
numero dispari = strumento curvo

**Länge oder Figur**

Length or Figure  
Longitud o figura  
Longueur ou figure  
Lunghezza o figura

INDEX

>> Klemmen • Hemostats • Pinzas hemostáticas • Pincas hémostatiques • Pinze emostatiche	7–54	AA
>> Pinzetten • Forceps • Pinzas • Pincas • Pinze	55–98	AB
>> Scheren • Scissors • Tijeras • Ciseaux • Forbici	99–162	AC
>> Skalpelle • Scalpels • Bisturies • Bistouris • Bisturi	163–178	AD
>> Naht • Suture • Sutura • Suture • Sutura	179–226	AE
>> Tupferzangen • Sponge Forceps >> Pinzas para pólipos • Pincas à pansements • Pinze per polipi	227–240	AF
>> Wundhaken • Retractors • Separadores • Ecarteurs • Divaricatori	241–308	AK
>> Sonden • Probes • Sondas • Sondes • Sonde	309–316	AL
>> Verband • Dressing • Vendajes • Pansements • Bendaggi	317–324	AM
>> Punktion/Kanülen • Puncture/Special Needles Punción/Agujas especiales • Ponction/Aiguilles spéciales • Puntura/Aghi speciali	325–350	AO
>> Narkose • Anaesthesia • Anestesia • Anesthésie • Anestesia	351–364	AP
>> Diagnostik • Diagnostics • Diagnóstico • Diagnostic • Diagnostica	365–382	AR
>> Orthopädie • Orthopaedic • Ortopedia • Orthopédie • Ortopedia	383–514	KA
>> Darm/Magen/Mastdarm • Intestines/Stomach/Rectum • Intestinos/Estómago/Recto Intestins/Estomac/Rectum • Intestini/Stomaco/Retto	515–554	KD
>> Verschiedenes • Various items • Diversos Articulos Articles divers • Articoli diversi		
>> Fußpflege • Podiatry • Pedicura • Soins des Pieds • Pedicure	555–580	KU
>> Reinigungsbürsten • Cleaning brushes • Cepillos de limpieza Brosses pour nettoyer • Spazzoli per pulire	581–592	KY



---

KLEMMEN  
HEMOSTATS  
PINZAS HEMOSTATICAS  
PINCES HEMOSTATIQUES  
PINZE EMOSTATICHE

AA

nopa<sup>®</sup> instruments



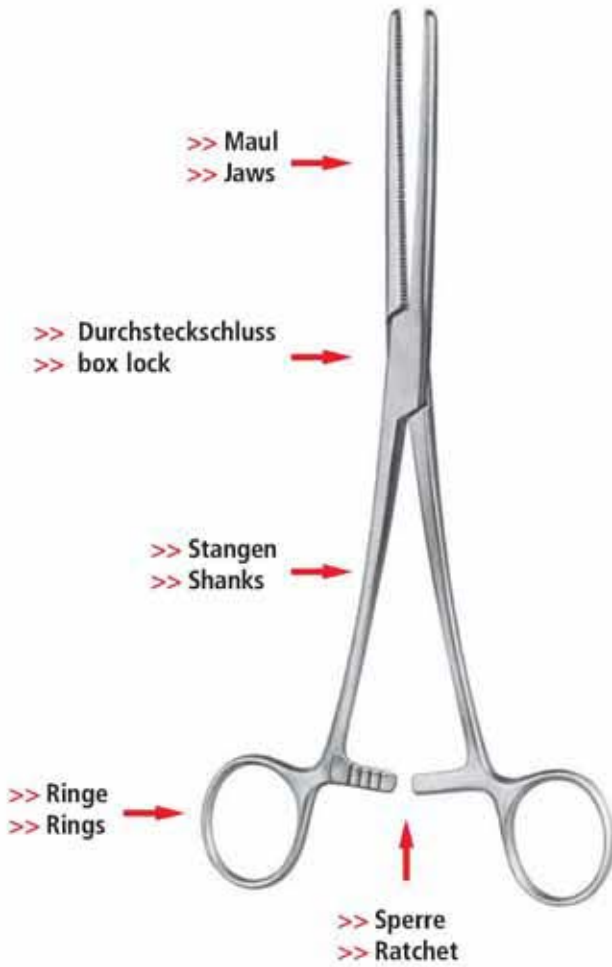

>> Maulbiegung  
>> jaw curvature

>> Riefung  
>> serrations



>> gerade  
>> straight

>> gebogen  
>> curved

>> quer  
>> horizontal

>> längs  
>> longitudinal

>> kreuz  
>> cross



KLEMMEN HEMOSTATS PINZAS HEMOSTATICAS PINCES HEMOSTATIQUES PINZE EMOSTATICHE

Gewebefasszangen, Darmfasszangen  
 Tissue Seizing Forceps  
 Pinzas para coger tejidos e intestinos  
 Pincers pour saisir le tissu et l'intestin  
 Pinze per afferrare tessuti e l'intestino

AA  
 AB  
 AC  
 AD  
 AE  
 AF  
 AK  
 AL  
 AM  
 AO  
 AP  
 AR  
 KA  
 KD  
 KU  
 KY



**ALLIS 4:5**  
 KD 054/15  
 15,0 cm/6"



**ALLIS 5:6**  
 15,0 cm/6"      KD 055/15  
 19,0 cm/7 1/2"      KD 055/19  
 25,0 cm/10"      KD 055/25



**BABCOCK**



KD 111/16  
 16,0 cm/6 1/4"



KD 111/18  
 18,0 cm/7"



KD 111/20  
 20,0 cm/8"



KD 111/24  
 24,0 cm/9 1/2"

**AA** KLEMMEN HEMOSTATS PINZAS HEMOSTATICAS PINCES HEMOSTATIQUES PINZE EMOSTATICHE

Bulldogklemmen  
Bulldog Clamps  
Clamps Bulldog  
Clamps Bulldog  
Pinze Bulldog



AA 050/01	AA 050/02	AA 050/03	AA 051/01	AA 051/02	AA 051/03
L <sub>1</sub> 50 mm	50 mm	60 mm	50 mm	50 mm	60 mm
L <sub>2</sub> 8 mm	12 mm	20 mm	8 mm	12 mm	20 mm

3 gr. 50 gr.  
Gewicht Druck  
Weight Pressure  
Peso Presión  
Poids Pression  
Peso Pressione

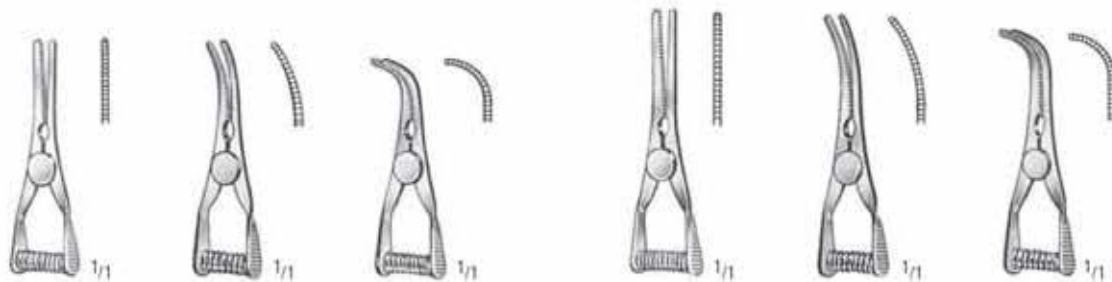

<b>VENA ARTERIA</b>	AA 052/01	<b>TITAN 30 mm</b>			AA 054/01	<b>TITAN 35 mm</b>	
	AA 053/01	AA 052/02	AA 052/03	AA 055/01	AA 054/02	AA 055/02	AA 054/03
		AA 053/02	AA 053/03		AA 055/03		

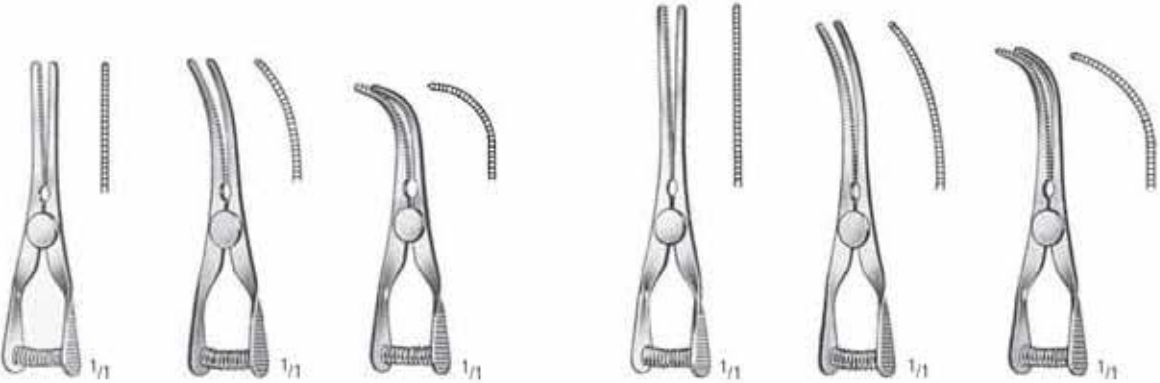

<b>VENA ARTERIA</b>	AA 056/01	<b>TITAN 40 mm</b>			AA 058/01	<b>TITAN 50 mm</b>	
	AA 057/01	AA 056/02	AA 056/03	AA 059/01	AA 058/02	AA 059/02	AA 058/03
		AA 057/02	AA 057/03		AA 059/03		

Bulldogklemmen, Anlegezange  
 Bulldog Clamps, Setting Forceps  
 Clamps Bulldog, Pinza para poner  
 Clamps Bulldog, Pince à poser  
 Pinze Bulldog, Pinza per posizionare



**DIEFFENBACH**

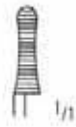

AA 060/03  
3,5 cm/1 1/2"

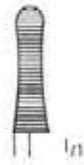

AA 060/05  
5,0 cm/2"

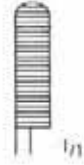

AA 060/06  
6,0 cm/2 1/2"



AA 061/03  
3,5 cm/1 1/2"



AA 061/05  
5,0 cm/2"

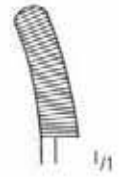

AA 061/06  
6,0 cm/2 1/2"



**JOHNS-HOPKINS**  
 AA 069/24  
 24,5 cm/9 3/4"



**JOHNS-HOPKINS**



AA 070/04  
4,0 cm/1 1/2"



AA 070/05  
5,0 cm/2"

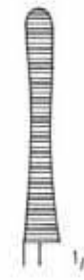

AA 070/06  
6,5 cm/2 1/2"

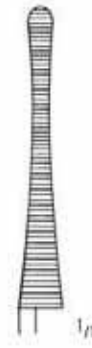

AA 070/07  
7,5 cm/3"

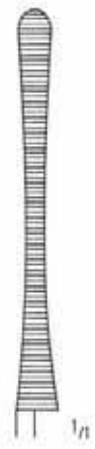

AA 070/09  
9,0 cm/3 1/2"

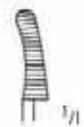

AA 071/04  
4,0 cm/1 1/2"



AA 071/05  
5,0 cm/2"

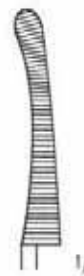

AA 071/06  
6,5 cm/2 1/2"



AA 071/07  
7,5 cm/3"

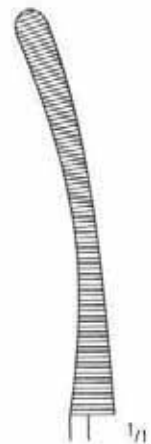

AA 071/09  
9,0 cm/3 1/2"

AA  
 AB  
 AC  
 AD  
 AE  
 AF  
 AG  
 AH  
 AI  
 AJ  
 AK  
 AL  
 AM  
 AN  
 AO  
 AP  
 AQ  
 AR  
 AS  
 AT  
 AU  
 AV  
 AW  
 AX  
 AY  
 AZ  
 BA  
 BB  
 BC  
 BD  
 BE  
 BF  
 BG  
 BH  
 BI  
 BJ  
 BK  
 BL  
 BM  
 BN  
 BO  
 BP  
 BQ  
 BR  
 BS  
 BT  
 BU  
 BV  
 BW  
 BX  
 BY  
 BZ  
 CA  
 CB  
 CC  
 CD  
 CE  
 CF  
 CG  
 CH  
 CI  
 CJ  
 CK  
 CL  
 CM  
 CN  
 CO  
 CP  
 CQ  
 CR  
 CS  
 CT  
 CU  
 CV  
 CW  
 CX  
 CY  
 CZ  
 DA  
 DB  
 DC  
 DD  
 DE  
 DF  
 DG  
 DH  
 DI  
 DJ  
 DK  
 DL  
 DM  
 DN  
 DO  
 DP  
 DQ  
 DR  
 DS  
 DT  
 DU  
 DV  
 DW  
 DX  
 DY  
 DZ  
 EA  
 EB  
 EC  
 ED  
 EE  
 EF  
 EG  
 EH  
 EI  
 EJ  
 EK  
 EL  
 EM  
 EN  
 EO  
 EP  
 EQ  
 ER  
 ES  
 ET  
 EU  
 EV  
 EW  
 EX  
 EY  
 EZ  
 FA  
 FB  
 FC  
 FD  
 FE  
 FF  
 FG  
 FH  
 FI  
 FJ  
 FK  
 FL  
 FM  
 FN  
 FO  
 FP  
 FQ  
 FR  
 FS  
 FT  
 FU  
 FV  
 FW  
 FX  
 FY  
 FZ  
 GA  
 GB  
 GC  
 GD  
 GE  
 GF  
 GG  
 GH  
 GI  
 GJ  
 GK  
 GL  
 GM  
 GN  
 GO  
 GP  
 GQ  
 GR  
 GS  
 GT  
 GU  
 GV  
 GW  
 GX  
 GY  
 GZ  
 HA  
 HB  
 HC  
 HD  
 HE  
 HF  
 HG  
 HH  
 HI  
 HJ  
 HK  
 HL  
 HM  
 HN  
 HO  
 HP  
 HQ  
 HR  
 HS  
 HT  
 HU  
 HV  
 HW  
 HX  
 HY  
 HZ  
 IA  
 IB  
 IC  
 ID  
 IE  
 IF  
 IG  
 IH  
 II  
 IJ  
 IK  
 IL  
 IM  
 IN  
 IO  
 IP  
 IQ  
 IR  
 IS  
 IT  
 IU  
 IV  
 IW  
 IX  
 IY  
 IZ  
 JA  
 JB  
 JC  
 JD  
 JE  
 JF  
 JG  
 JH  
 JI  
 JJ  
 JK  
 JL  
 JM  
 JN  
 JO  
 JP  
 JQ  
 JR  
 JS  
 JT  
 JU  
 JV  
 JW  
 JX  
 JY  
 JZ  
 KA  
 KB  
 KC  
 KD  
 KE  
 KF  
 KG  
 KH  
 KI  
 KJ  
 KK  
 KL  
 KM  
 KN  
 KO  
 KP  
 KQ  
 KR  
 KS  
 KT  
 KU  
 KV  
 KW  
 KX  
 KY  
 KZ  
 LA  
 LB  
 LC  
 LD  
 LE  
 LF  
 LG  
 LH  
 LI  
 LJ  
 LK  
 LL  
 LM  
 LN  
 LO  
 LP  
 LQ  
 LR  
 LS  
 LT  
 LU  
 LV  
 LW  
 LX  
 LY  
 LZ  
 MA  
 MB  
 MC  
 MD  
 ME  
 MF  
 MG  
 MH  
 MI  
 MJ  
 MK  
 ML  
 MM  
 MN  
 MO  
 MP  
 MQ  
 MR  
 MS  
 MT  
 MU  
 MV  
 MW  
 MX  
 MY  
 MZ  
 NA  
 NB  
 NC  
 ND  
 NE  
 NF  
 NG  
 NH  
 NI  
 NJ  
 NK  
 NL  
 NM  
 NN  
 NO  
 NP  
 NQ  
 NR  
 NS  
 NT  
 NU  
 NV  
 NW  
 NX  
 NY  
 NZ  
 OA  
 OB  
 OC  
 OD  
 OE  
 OF  
 OG  
 OH  
 OI  
 OJ  
 OK  
 OL  
 OM  
 ON  
 OO  
 OP  
 OQ  
 OR  
 OS  
 OT  
 OU  
 OV  
 OW  
 OX  
 OY  
 OZ  
 PA  
 PB  
 PC  
 PD  
 PE  
 PF  
 PG  
 PH  
 PI  
 PJ  
 PK  
 PL  
 PM  
 PN  
 PO  
 PP  
 PQ  
 PR  
 PS  
 PT  
 PU  
 PV  
 PW  
 PX  
 PY  
 PZ  
 QA  
 QB  
 QC  
 QD  
 QE  
 QF  
 QG  
 QH  
 QI  
 QJ  
 QK  
 QL  
 QM  
 QN  
 QO  
 QP  
 QQ  
 QR  
 QS  
 QT  
 QU  
 QV  
 QW  
 QX  
 QY  
 QZ  
 RA  
 RB  
 RC  
 RD  
 RE  
 RF  
 RG  
 RH  
 RI  
 RJ  
 RK  
 RL  
 RM  
 RN  
 RO  
 RP  
 RQ  
 RR  
 RS  
 RT  
 RU  
 RV  
 RW  
 RX  
 RY  
 RZ  
 SA  
 SB  
 SC  
 SD  
 SE  
 SF  
 SG  
 SH  
 SI  
 SJ  
 SK  
 SL  
 SM  
 SN  
 SO  
 SP  
 SQ  
 SR  
 SS  
 ST  
 SU  
 SV  
 SW  
 SX  
 SY  
 SZ  
 TA  
 TB  
 TC  
 TD  
 TE  
 TF  
 TG  
 TH  
 TI  
 TJ  
 TK  
 TL  
 TM  
 TN  
 TO  
 TP  
 TQ  
 TR  
 TS  
 TT  
 TU  
 TV  
 TW  
 TX  
 TY  
 TZ  
 UA  
 UB  
 UC  
 UD  
 UE  
 UF  
 UG  
 UH  
 UI  
 UJ  
 UK  
 UL  
 UM  
 UN  
 UO  
 UP  
 UQ  
 UR  
 US  
 UT  
 UY  
 UZ  
 VA  
 VB  
 VC  
 VD  
 VE  
 VF  
 VG  
 VH  
 VI  
 VJ  
 VK  
 VL  
 VM  
 VN  
 VO  
 VP  
 VQ  
 VR  
 VS  
 VT  
 VU  
 VV  
 VW  
 VX  
 VY  
 VZ  
 WA  
 WB  
 WC  
 WD  
 WE  
 WF  
 WG  
 WH  
 WI  
 WJ  
 WK  
 WL  
 WM  
 WN  
 WO  
 WP  
 WQ  
 WR  
 WS  
 WT  
 WU  
 WV  
 WW  
 WX  
 WY  
 WZ  
 XA  
 XB  
 XC  
 XD  
 XE  
 XF  
 XG  
 XH  
 XI  
 XJ  
 XK  
 XL  
 XM  
 XN  
 XO  
 XP  
 XQ  
 XR  
 XS  
 XT  
 XU  
 XV  
 XW  
 XX  
 XY  
 XZ  
 YA  
 YB  
 YC  
 YD  
 YE  
 YF  
 YG  
 YH  
 YI  
 YJ  
 YK  
 YL  
 YM  
 YN  
 YO  
 YP  
 YQ  
 YR  
 YS  
 YT  
 YU  
 YV  
 YW  
 YX  
 YY  
 YZ  
 ZA  
 ZB  
 ZC  
 ZD  
 ZE  
 ZF  
 ZG  
 ZH  
 ZI  
 ZJ  
 ZK  
 ZL  
 ZM  
 ZN  
 ZO  
 ZP  
 ZQ  
 ZR  
 ZS  
 ZT  
 ZU  
 ZV  
 ZW  
 ZX  
 ZY  
 ZZ

**AA** KLEMMEN HEMOSTATS PINZAS HEMOSTATICAS PINCES HEMOSTATIQUES PINZE EMOSTATICHE

Fasszangen, Gefäßklemme, Kopfhautklemmen  
 Seizing Forceps, Blood Vessel Clamps, Scalp Flap Forceps  
 Pinzas para coger, Clamps para vasos, Pinzas hemostáticas para pericráneo  
 Pincers à saisir, Pincers vasculaire, Pincers hémostatiques pour le cuir chevelu  
 Pinze per afferrare, Pinza per vasi, Pinze emostatiche per il cuoio capelluto



**CHAPUT**  
 AA 072/02  
 13,0 cm/5"



**TUFFIER**  
 AA 072/04  
 13,0 cm/5"

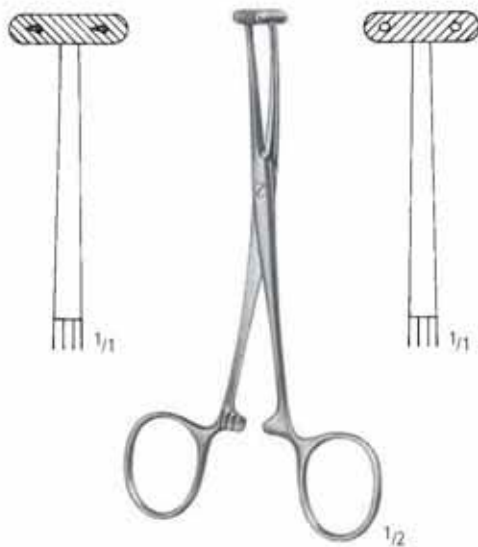

**MARTEL**  
 AA 078/14  
 14,0 cm/5½"

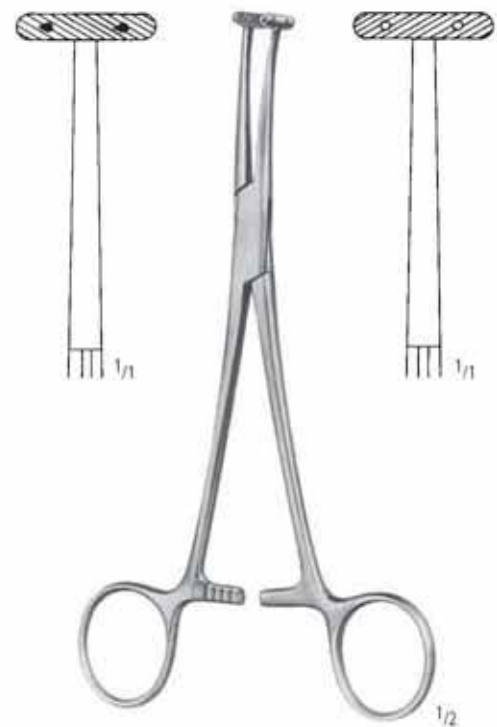

**WILLET-MARTEL**  
 AA 078/19  
 19,0 cm/7½"

Arterienklemmen, Faszangen  
 Artery Forceps, Seizing Forceps  
 Pinzas hemostáticas, Pinzas para coger  
 Pincés hémostatiques, Pincés à saisir  
 Pinze emostatiche, Pinze per afferrare

AA  
 AB  
 AC  
 AD  
 AE  
 AF  
 AK  
 AL  
 AM  
 AO  
 AP  
 AR  
 KA  
 KD  
 KU  
 KY



AA 080/14



AA 080/16

**PEAN**  
 14,0 cm/5½"  
 16,0 cm/6¼"



**KROENLEIN**  
 AA 082/13  
 13,0 cm/5"



AA 084/15

**PENNINGTON**  
 15,5 cm/6"  
 20,0 cm/8"

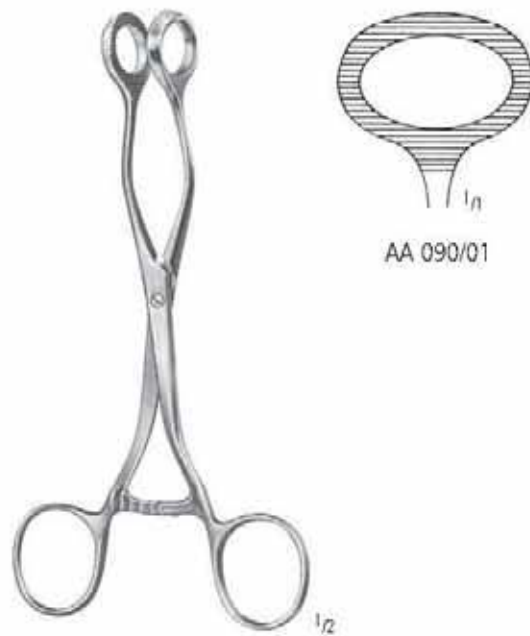

AA 090/01

**COLLIN**  
 16,0 cm/6¼"



**AA** KLEMMEN HEMOSTATS PINZAS HEMOSTATICAS PINCES HEMOSTATIQUES PINZE EMOSTATICHE

Arterienklemmen  
 Artery Forceps  
 Pinzas hemostáticas  
 Pincres hémostatiques  
 Pinze emostatiche



**SPENCER-WELLS**

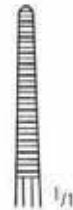

AA 110/13  
 13,0 cm/5"

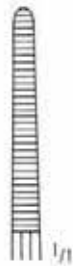

AA 110/14  
 14,0 cm/5½"

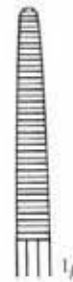

AA 110/15  
 15,5 cm/6"

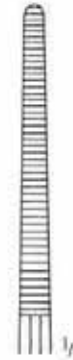

AA 110/18  
 18,0 cm/7"

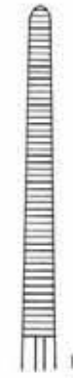

AA 110/20  
 20,0 cm/8"

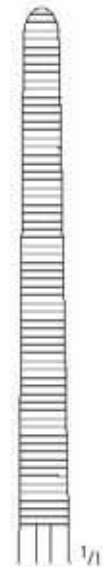

AA 110/36  
 36,0 cm/14"



AA 111/13  
 13,0 cm/5"



AA 111/14  
 14,0 cm/5½"



AA 111/15  
 15,5 cm/6"

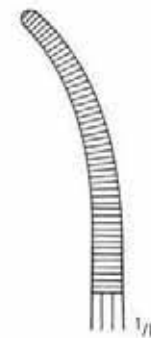

AA 111/18  
 18,0 cm/7"

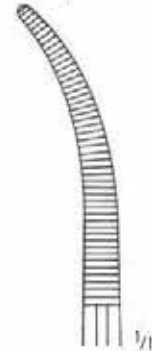

AA 111/20  
 20,0 cm/8"



**HARTMANN**  
 AA 114/10  
 10,0 cm/4"



**HARTMANN**  
 AA 115/10  
 10,0 cm/4"



**CARREL**  
 AA 116/08  
 8,5 cm/3½"



**TERRIER 1:2**  
 AA 118/08  
 8,5 cm/3½"



Feine Arterienklemmen  
 Fine Artery Forceps  
 Pinzas hemostáticas finas  
 Pincas hémostatiques fines  
 Pinze emostatiche fine

AA

AB

AC

AD

AE

AF

AK

AL

AM

AO

AP

AR

KA

KD

KU

KY

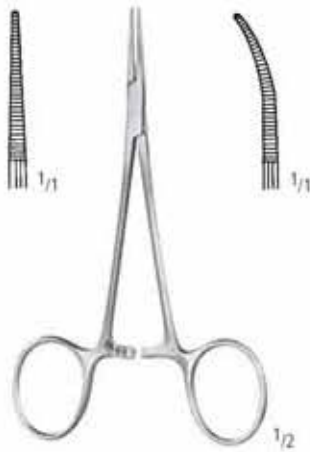

**MICRO-MOSQUITO**

AA 130/10      AA 131/10  
 AA 130/12      AA 131/12

10,0 cm/4"  
 12,0 cm/4<sup>3</sup>/<sub>4</sub>"



**MICRO-MOSQUITO 1:2**

AA 132/10      AA 133/10  
 AA 132/12      AA 133/12

**WILLIAM STEWART HALSTED**

was professor of surgery in the Johns Hopkins University. In 1890 he had bronze casts made of his own hands. On these casts the first surgical rubber gloves were moulded.

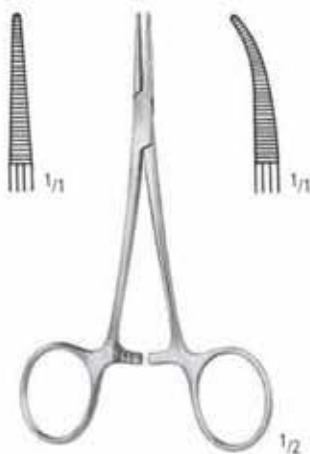

**HALSTED-MOSQUITO**

AA 150/12      AA 151/12  
 AA 150/14      AA 151/14

12,5 cm/5"  
 14,0 cm/5<sup>1</sup>/<sub>2</sub>"

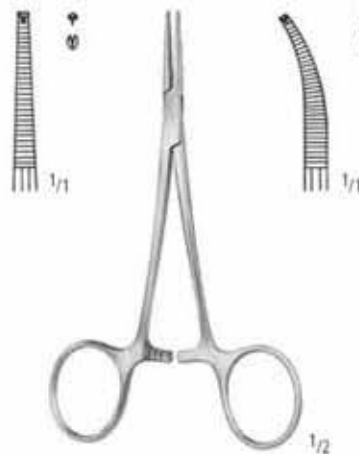

**HALSTED-MOSQUITO 1:2**

AA 152/12      AA 153/12  
 AA 152/14      AA 153/14

**AA** KLEMMEN HEMOSTATS PINZAS HEMOSTATICAS PINCES HEMOSTATIQUES PINZE EMOSTATICHE

Arterienklemmen  
 Artery Forceps  
 Pinzas hemostáticas  
 Pincres hémostatiques  
 Pinze emostatiche

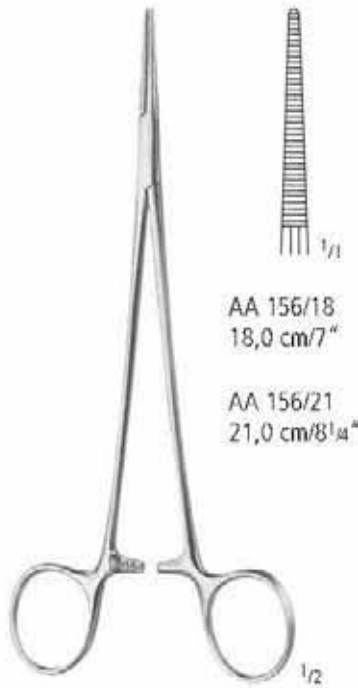

AA 156/18  
 18,0 cm/7"  
 AA 156/21  
 21,0 cm/8<sup>1</sup>/<sub>4</sub>"

**HALSTED**



AA 157/18  
 18,0 cm/7"  
 AA 157/21  
 21,0 cm/8<sup>1</sup>/<sub>4</sub>"

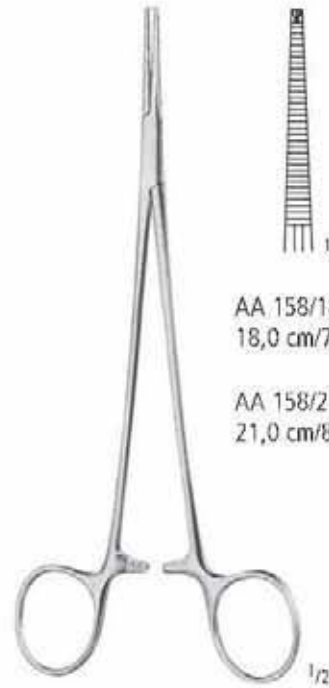

AA 158/18  
 18,0 cm/7"  
 AA 158/21  
 21,0 cm/8<sup>1</sup>/<sub>4</sub>"

**HALSTED 1:2**

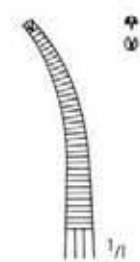

AA 159/18  
 18,0 cm/7"  
 AA 159/21  
 21,0 cm/8<sup>1</sup>/<sub>4</sub>"

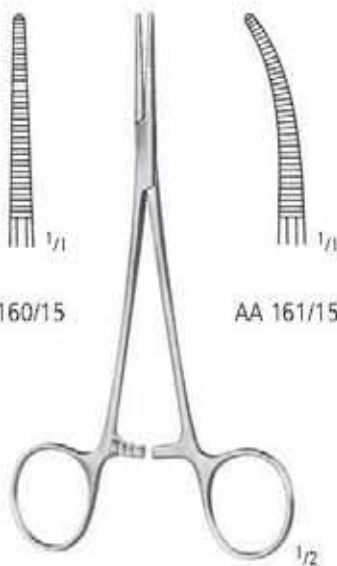

AA 160/15 AA 161/15

**LERICHE**  
 15,0 cm/6"

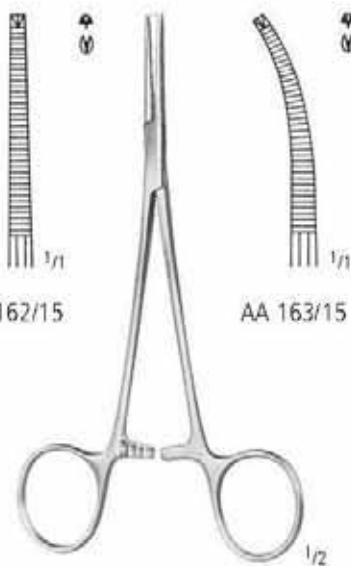

AA 162/15 AA 163/15

**LERICHE 1:2**  
 15,0 cm/6"

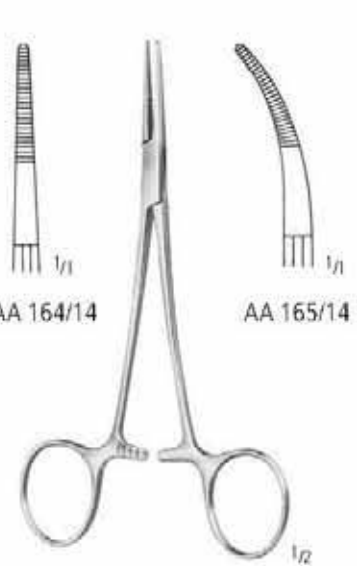

AA 164/14 AA 165/14

**PROVIDENCE-HOSPITAL**  
 14,0 cm/5<sup>1</sup>/<sub>2</sub>"

Arterienklemmen  
 Artery Forceps  
 Pinzas hemostáticas  
 Pincas hémostatiques  
 Pinze emostatiche

AA  
 AB  
 AC  
 AD  
 AE  
 AF  
 AG  
 AH  
 AI  
 AJ  
 AK  
 AL  
 AM  
 AN  
 AO  
 AP  
 AQ  
 AR  
 AS  
 AT  
 AU  
 AV  
 AW  
 AX  
 AY  
 AZ

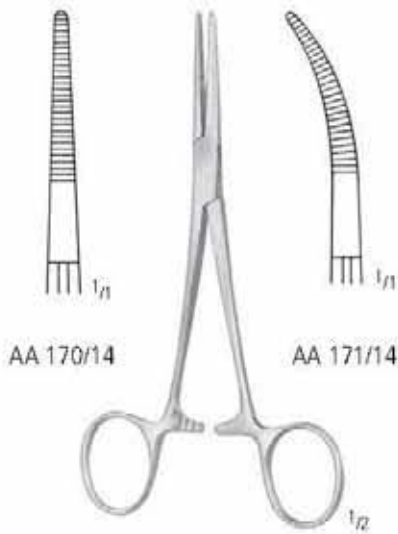

**KELLY**  
 14,0 cm/5 1/2"

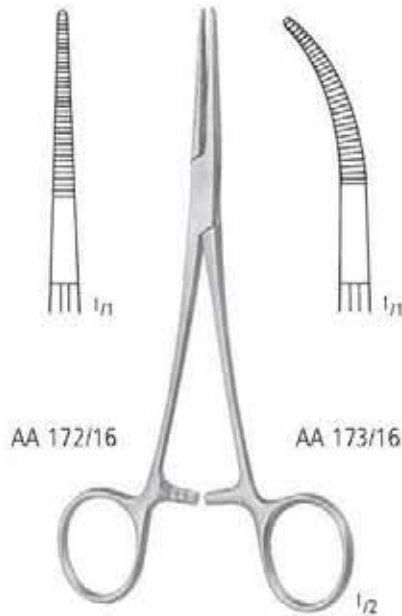

**KELLY-RANKIN**  
 16,0 cm/6 1/4"

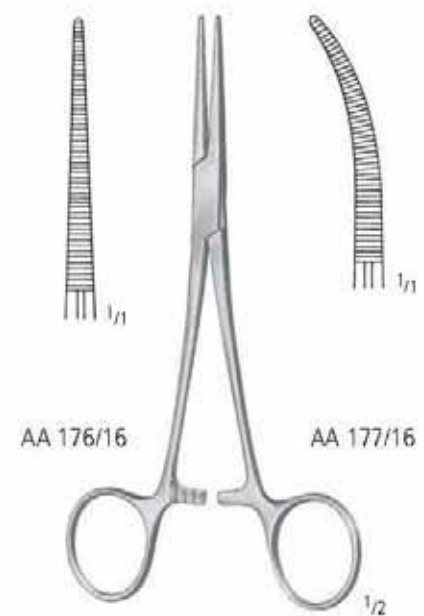

**COLLER**  
 AA 176/14 14,0 cm/5 1/2" AA 177/14  
 AA 176/16 16,0 cm/6 1/4" AA 177/16

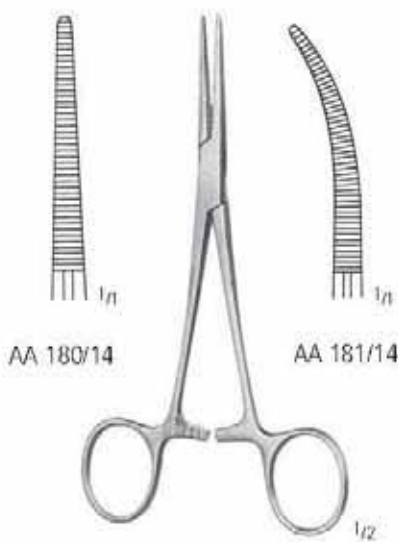

**CRILE**  
 14,0 cm/5 1/2"

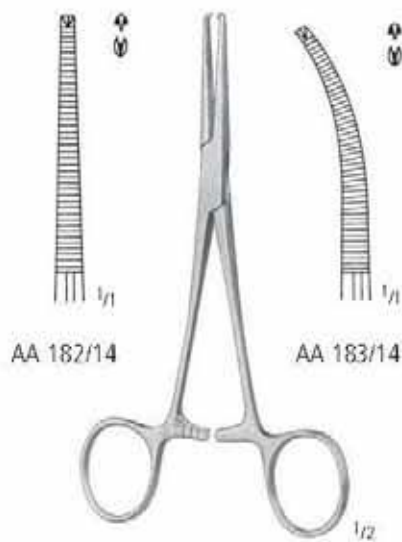

**CRILE 1:2**  
 14,0 cm/5 1/2"

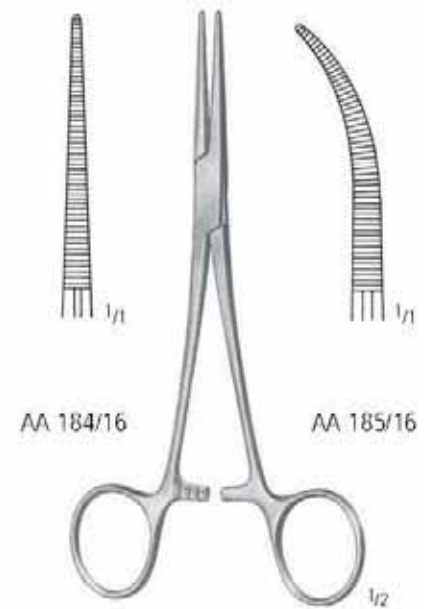

**CRILE-RANKIN**  
 16,0 cm/6 1/4"

Arterienklemmen  
 Artery Forceps  
 Pinzas hemostáticas  
 Pincres hémostatiques  
 Pinze emostatiche



**ROCHESTER-PEAN**



AA 200/14  
 14,0 cm/5 1/2"

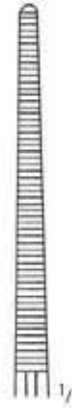

AA 200/16  
 16,0 cm/6 1/4"

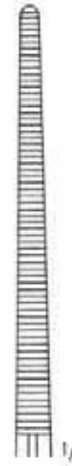

AA 200/18  
 18,0 cm/7"

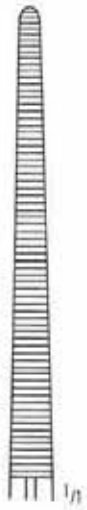

AA 200/20  
 20,0 cm/8"

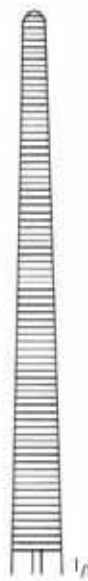

AA 200/22  
 22,0 cm/8 3/4"

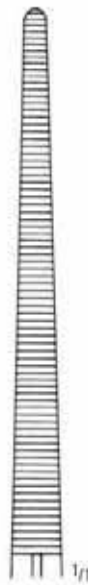

AA 200/24  
 24,0 cm/9 1/2"

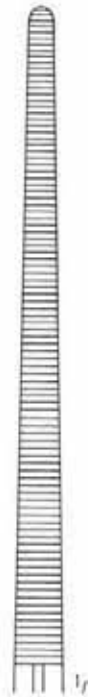

AA 200/26  
 26,0 cm/10 1/2"

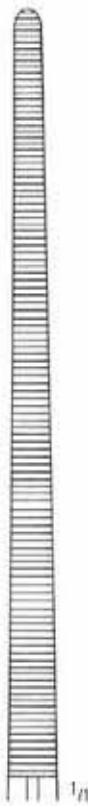

AA 200/30  
 30,0 cm/12"



AA 200/36  
 36,0 cm/14"

Arterienklemmen  
 Artery Forceps  
 Pinzas hemostáticas  
 Pincas hémostatiques  
 Pinze emostatiche



ROCHESTER-PEAN

1/2

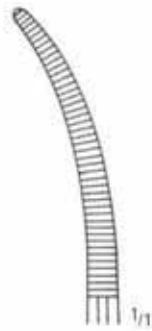

AA 201/14  
 14,0 cm/5 1/2"

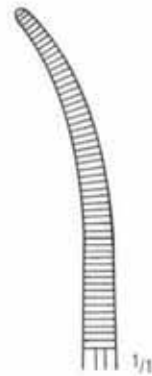

AA 201/16  
 16,0 cm/6 1/4"

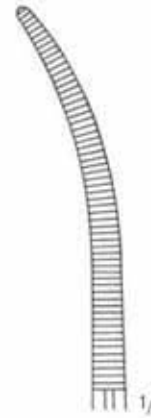

AA 201/18  
 18,0 cm/7"

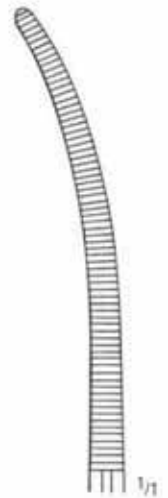

AA 201/20  
 20,0 cm/8"

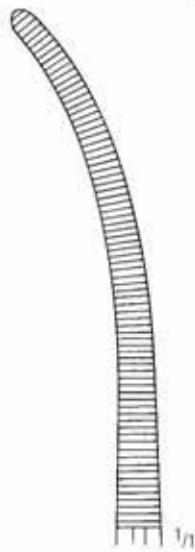

AA 201/22  
 22,0 cm/8 3/4"

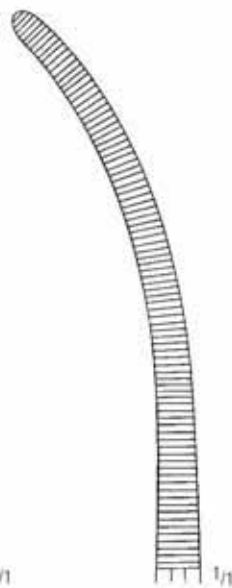

AA 201/24  
 24,0 cm/9 1/2"

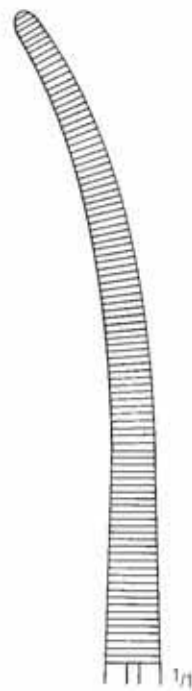

AA 201/26  
 26,0 cm/10 1/2"

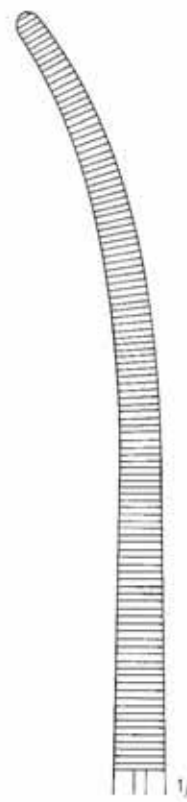

AA 201/30  
 30,0 cm/12"

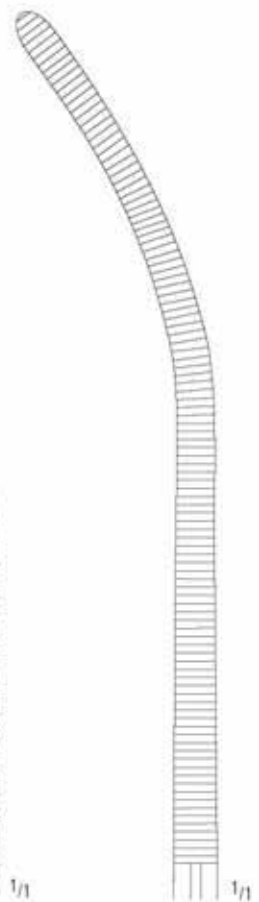

AA 201/36  
 36,0 cm/14"

AA

AB

AC

AD

AE

AF

AK

AL

AM

AO

AP

AR

KA

KD

KU

KY



Arterienklemmen  
 Artery Forceps  
 Pinzas hemostáticas  
 Pincres hémostatiques  
 Pinze emostatiche



OCHSNER-KOCHER 1:2

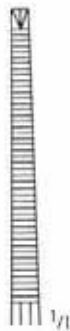

AA 210/14  
 14,0 cm/5 1/2"

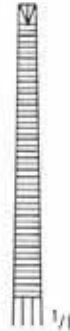

AA 210/16  
 16,0 cm/6 1/4"

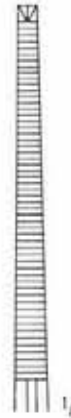

AA 210/18  
 18,0 cm/7"

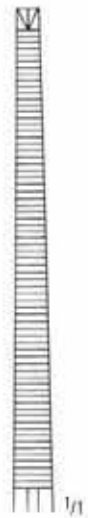

AA 210/20  
 20,0 cm/8"



AA 210/22  
 22,0 cm/8 3/4"

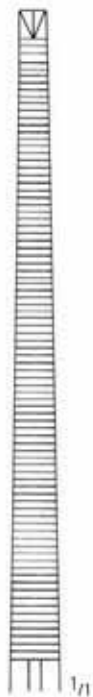

AA 210/24  
 24,0 cm/9 1/2"



AA 210/26  
 26,0 cm/10 1/2"

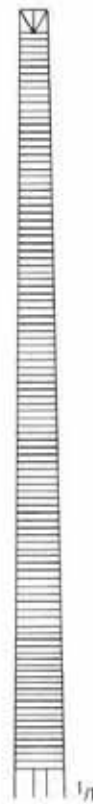

AA 210/30  
 30,0 cm/12"

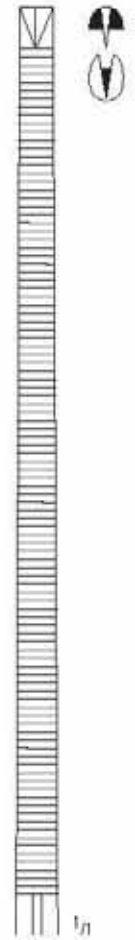

AA 210/36  
 36,0 cm/14"



KLEMMEN HEMOSTATS PINZAS HEMOSTATICAS PINCES HEMOSTATIQUES PINZE EMOSTATICHE

Arterienklemmen  
 Artery Forceps  
 Pinzas hemostáticas  
 Pincas hémostatiques  
 Pinze emostatiche

AA

AB

AC

AD

AE

AF

AK

AL

AM

AO

AP

AR

KA

KD

KU

KY



OCHSNER-KOCHER 1:2



AA 211/14  
 14,0 cm/5 1/2"

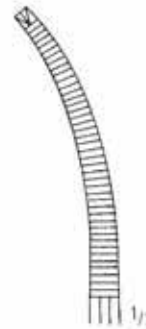

AA 211/16  
 16,0 cm/6 1/4"

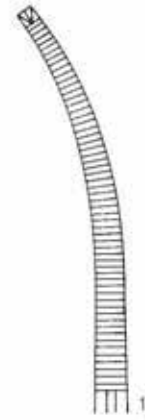

AA 211/18  
 18,0 cm/7"



AA 211/20  
 20,0 cm/8"

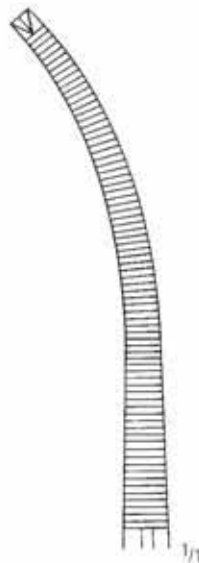

AA 211/22  
 22,0 cm/8 3/4"

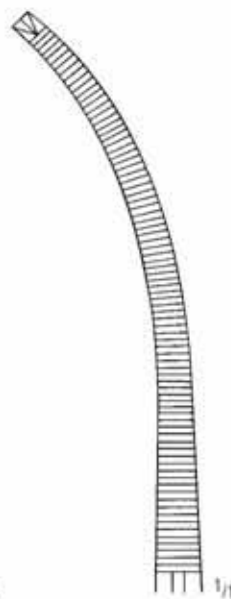

AA 211/24  
 24,0 cm/9 1/2"

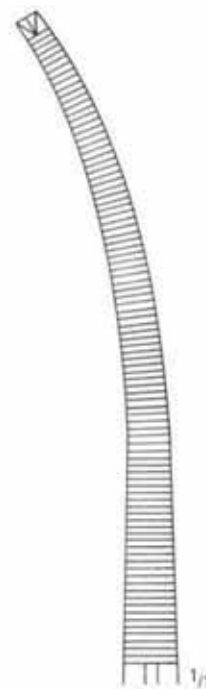

AA 211/26  
 26,0 cm/10 1/2"

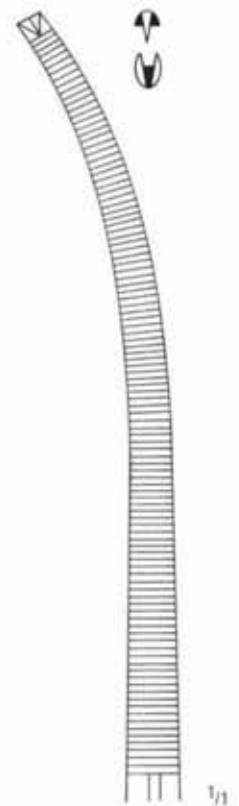

AA 211/30  
 30,0 cm/12"

Grazile Arterienklemmen  
 Delicate Artery Forceps  
 Pinzas hemostáticas delgadas  
 Pincres hémostatiques graciles  
 Pinze emostatiche delicate

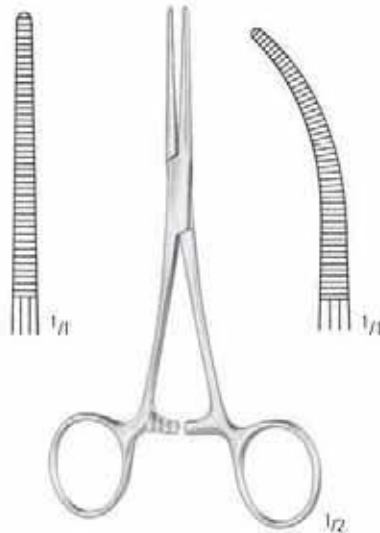

**PEAN - DELICATE**

AA 214/13	AA 215/13
AA 214/14	AA 215/14
AA 214/16	AA 215/16

13,0 cm/5"  
 14,0 cm/5 1/2"  
 16,0 cm/6 1/4"

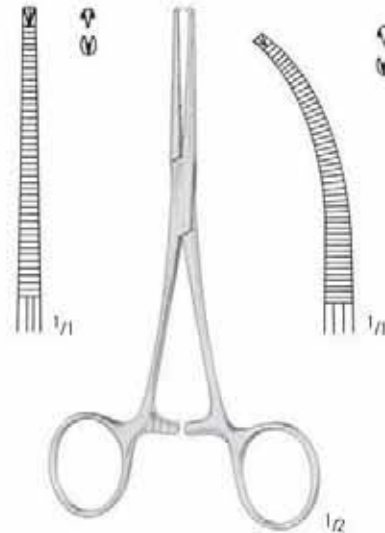

**KOCHER 1:2 - DELICATE**

AA 216/13	AA 217/13
AA 216/14	AA 217/14
AA 216/16	AA 217/16

**JULES PEAN**, born 1830, died 1898, was the most important French gynecological surgeon of his time. He studied at Paris 1860. 1864 Pean was the first surgeon in Paris to perform an ovariectomy. By the use of Pean pins he introduced forceps pressure for control of hemorrhage, thus he invented the most used surgical instrument, next to the scalpel.

**ALBERT J. OCHSNER**, born 1858, died 1925. He devoted much time to attending and participating in medical discussions and was member of all leading societies in his fields.

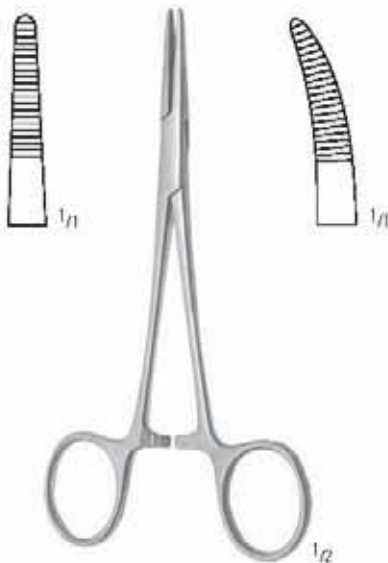

**CAIRNS**

AA 218/15	15,0 cm/6"	AA 219/15
-----------	------------	-----------



**DUNHILL**

AA 220/13  
 13,0 cm/5"

KLEMMEN HEMOSTATS PINZAS HEMOSTATICAS PINCES HEMOSTATIQUES PINZE EMOSTATICHE

Arterienklemmen, Präparier- und Ligaturklemmen  
 Artery Forceps, Dissecting and Ligature Forceps  
 Pinzas hemostáticas, Pinzas para preparaciones y ligaduras  
 Pincas hémostatiques, Pincas à disséquer et à ligatures  
 Pinze emostatiche, Pinze per preparazioni e legature

AA  
 AB  
 AC  
 AD  
 AE  
 AF  
 AK  
 AL  
 AM  
 AO  
 AP  
 AR  
 KA  
 KD  
 KU  
 KY



**OVERHOLT-GEISSENDOERFER**

21,0 cm/8<sup>1</sup>/<sub>4</sub>"  
 27,0 cm/10<sup>3</sup>/<sub>4</sub>"

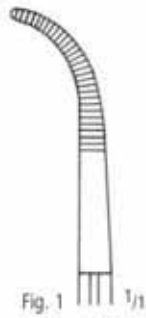

Fig. 1 1/1

AA 221/01  
 AA 223/01

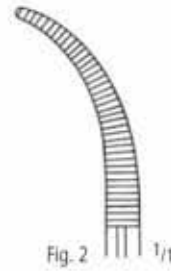

Fig. 2 1/1

AA 221/02  
 AA 223/02

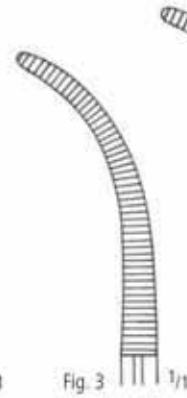

Fig. 3 1/1

AA 221/03  
 AA 223/03

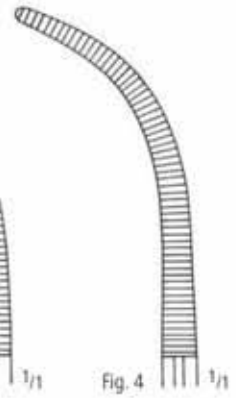

Fig. 4 1/1

AA 221/04  
 AA 223/04

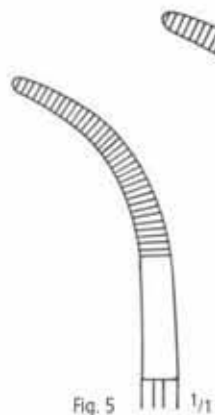

Fig. 5 1/1

AA 221/05  
 AA 223/05

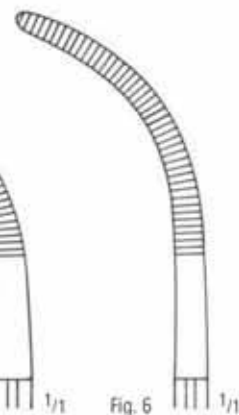

Fig. 6 1/1

AA 221/06  
 AA 223/06

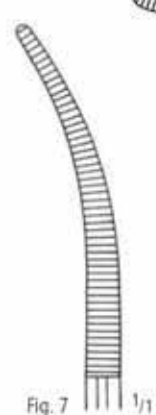

Fig. 7 1/1

AA 221/07  
 AA 223/07

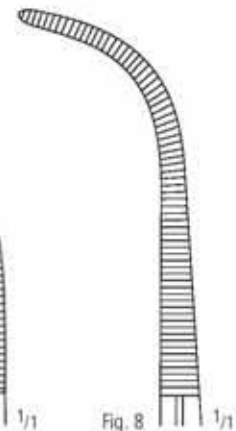

Fig. 8 1/1

AA 224/08



**BABY-OVERHOLT**

AA 225/13  
 13,5 cm/5<sup>1</sup>/<sub>4</sub>"

Präparier- und Ligaturklemmen  
 Dissecting and Ligature Forceps  
 Pinzas para preparaciones y ligaduras  
 Pinces à disséquer et à ligatures  
 Pinze per preparazioni e legature



**OVERHOLT**  
 AA 229/01  
 18,5 cm/7 1/3"



**OVERHOLT**  
 AA 229/02  
 20,5 cm/8"

S-förmig gebogen  
 S-shaped  
 curvas en S  
 courbes en S  
 curve in S



**OVERHOLT**  
 AA 229/03  
 21,0 cm/8 1/4"



**OVERHOLT**  
 AA 229/04  
 21,5 cm/8 1/2"

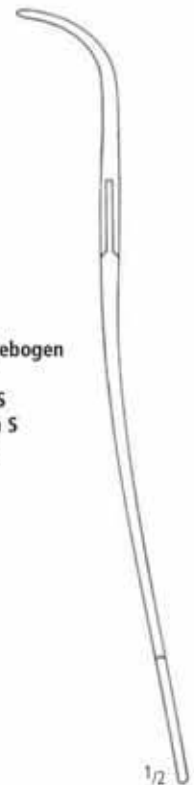

KLEMMEN HEMOSTATS PINZAS HEMOSTATICAS PINCES HEMOSTATIQUES PINZE EMOSTATICHE

Arterienklemmen, Präparier- und Ligaturklemmen  
 Artery Forceps, Dissecting and Ligature Forceps  
 Pinzas hemostáticas, Pinzas para preparaciones y ligaduras  
 Pincas hémostatiques, Pincas à disséquer et à ligatures  
 Pinze emostatiche, Pinze per preparazioni e legature

AA

AB

AC

AD

AE

AF

AK

AL

AM

AO

AP

AR

KA

KD

KU

KY



**BABY-ADSON**  
 AA 235/14  
 14,0 cm/5 1/2"



**BABY-ADSON**  
 AA 237/18  
 18,0 cm/7"



AA 238/18

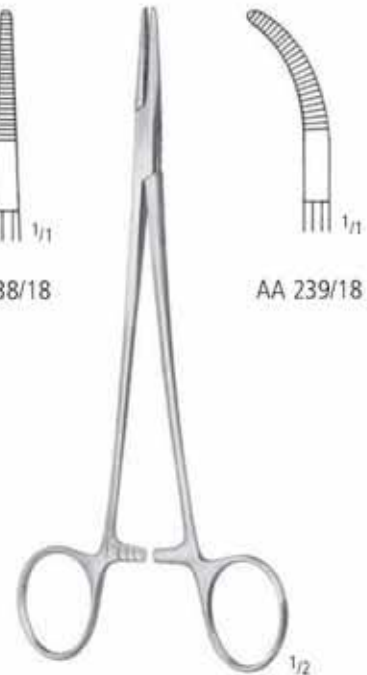

AA 239/18

**ADSON**  
 18,5 cm/7 1/3"

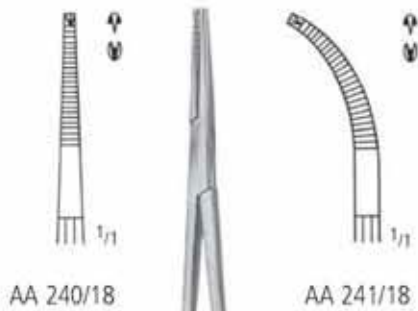

AA 240/18

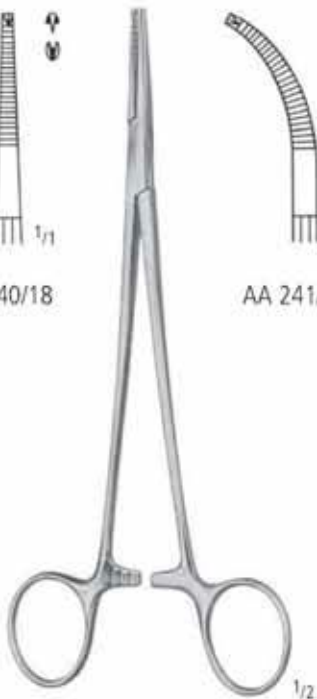

AA 241/18

**ADSON 1:2**  
 18,5 cm/7 1/3"



AA 251/18  
 18,0 cm/7"



**MEEKER**

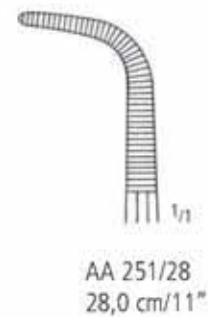

AA 251/28  
 28,0 cm/11"

**AA** KLEMMEN HEMOSTATS PINZAS HEMOSTATICAS PINCES HEMOSTATIQUES PINZE EMOSTATICHE

Arterienklemmen, Kopfhautklemmen  
 Artery Forceps, Scalp Flap Forceps  
 Pinzas hemostáticas, Pinzas hemostáticas para pericráneo  
 Pincés hémostatiques, Pincés hémostatiques pour le cuir chevelu  
 Pinze emostatiche, Pinze emostatiche per il cuoio capelluto



**DIXON-LOVELACE**  
 AA 286/15  
 15,5 cm/6"



**DIXON-LOVELACE 1:2**  
 AA 288/15  
 15,5 cm/6"

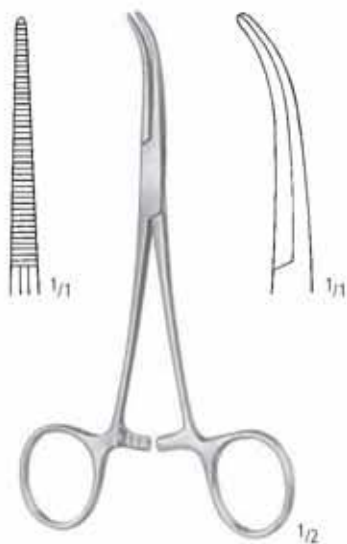

**DANDY**  
 AA 291/14  
 14,0 cm/5 1/2"

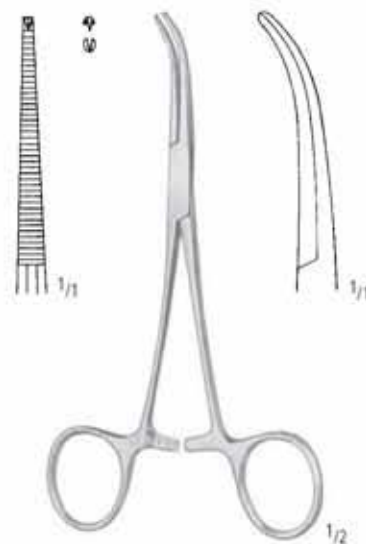

**DANDY 1:2**  
 AA 293/14  
 14,0 cm/5 1/2"



Tonsillenklappen, Arterienklappen  
 Tonsil Hemostatic Forceps, Artery Forceps  
 Pinzas hemostáticas para amígdalas, Pinzas hemostáticas  
 Pincers hémostatiques pour amygdales, Pincers hémostatiques  
 Pinze emostatiche per tonsille, Pinze emostatiche

AA

AB

AC

AD

AE

AF

AK

AL

AM

AO

AP

AR

KA

KD

KU

KY

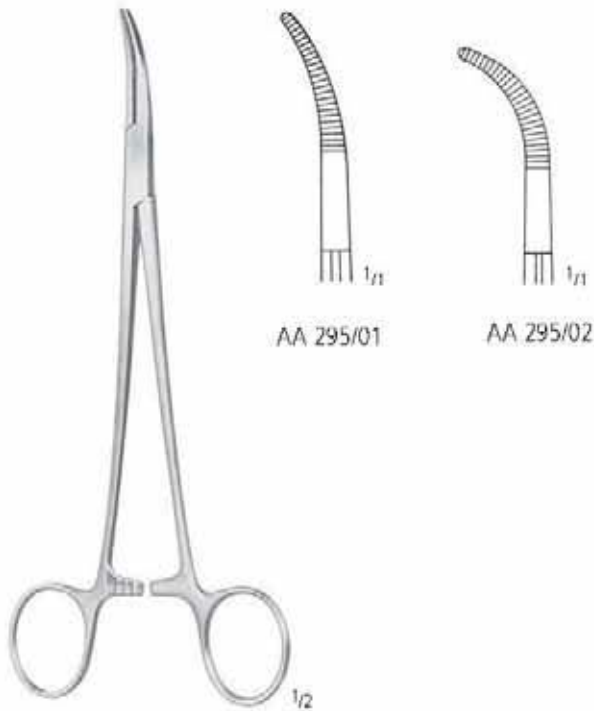

AA 295/01

AA 295/02

**SCHNIDT-SAWTELL**  
 19,0 cm/7 1/2"

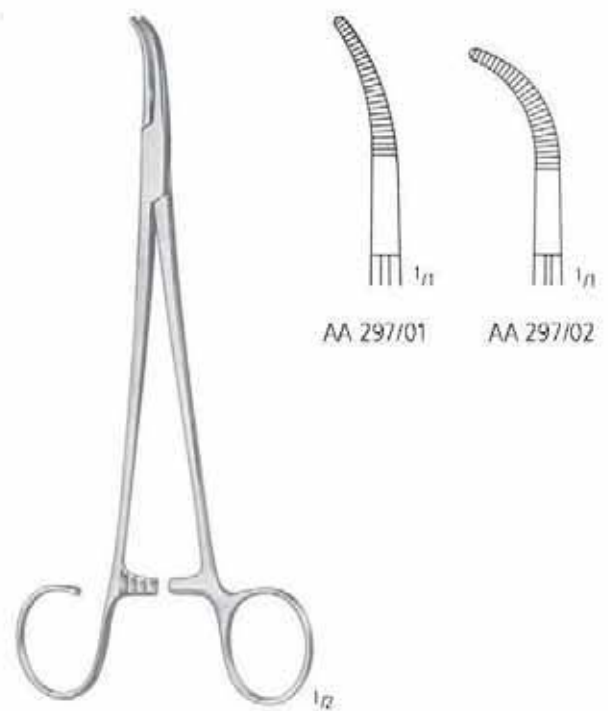

AA 297/01

AA 297/02

**SCHNIDT-SAWTELL**  
 19,0 cm/7 1/2"

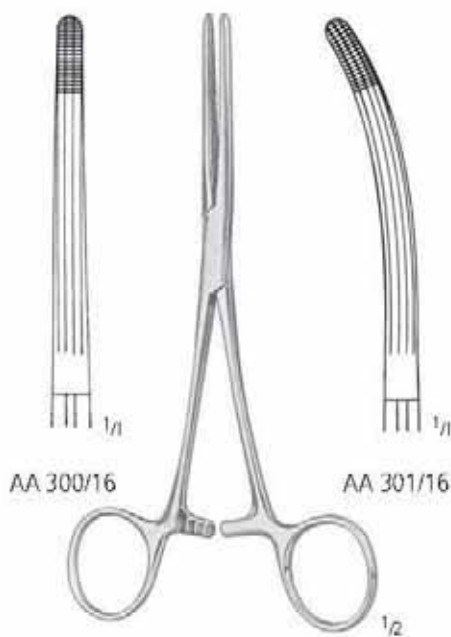

AA 300/16

AA 301/16

**ROCHESTER-CARMALT**

AA 300/16  
 AA 300/20

16,0 cm/6 1/4"  
 20,0 cm/8"

AA 301/16  
 AA 301/20

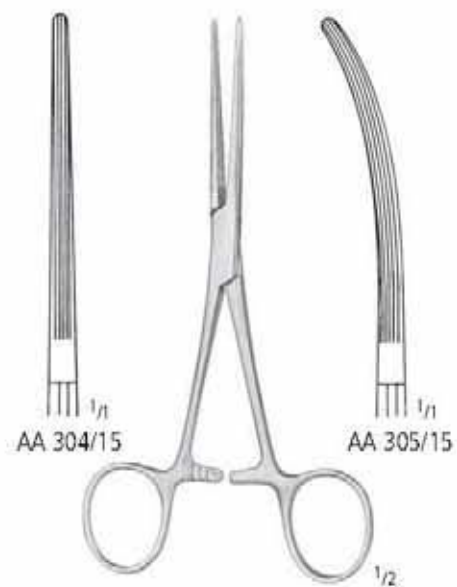

AA 304/15

AA 305/15

**BAINBRIDGE**

AA 304/15  
 AA 304/18

15,0 cm/6"  
 18,5 cm/7 1/3"

AA 305/15  
 AA 305/18

Arterienklemmen  
 Artery Forceps  
 Pinzas hemostáticas  
 Pincres hémostatiques  
 Pinze emostatiche

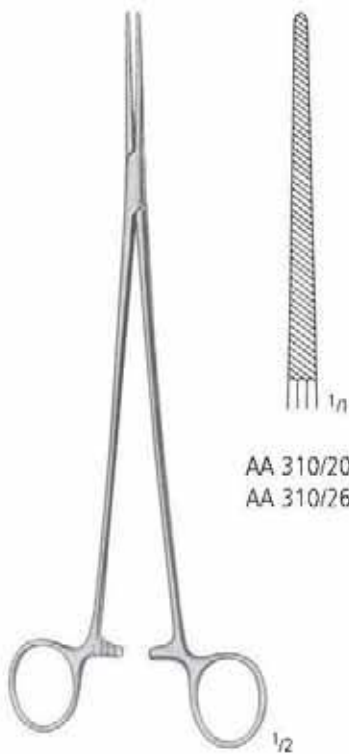

AA 310/20  
 AA 310/26

20,0 cm/8"  
 26,0 cm/10 1/2"

**BENGOLEA**



AA 311/20  
 AA 311/26

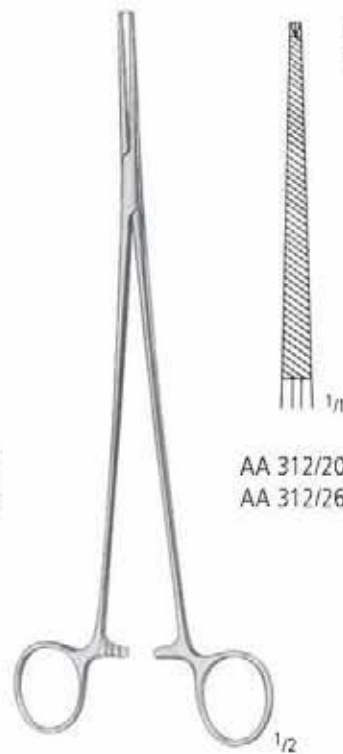

AA 312/20  
 AA 312/26

20,0 cm/8"  
 26,0 cm/10 1/2"

**BENGOLEA 1:2**

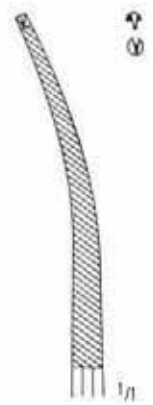

AA 313/20  
 AA 313/26

Aurikelklemmen, Präparier- und Ligaturklemmen  
 Auricle Forceps, Dissecting and Ligature Forceps  
 Pinzas para aurícula, Pinzas para preparaciones y ligaduras  
 Pincés auriculaires, Pincés à disséquer et à ligatures  
 Pinza auricolari, Pinze per preparazioni e legature

AA

AB

AC

AD

AE

AF

AK

AL

AM

AO

AP

AR

KA

KD

KU

KY

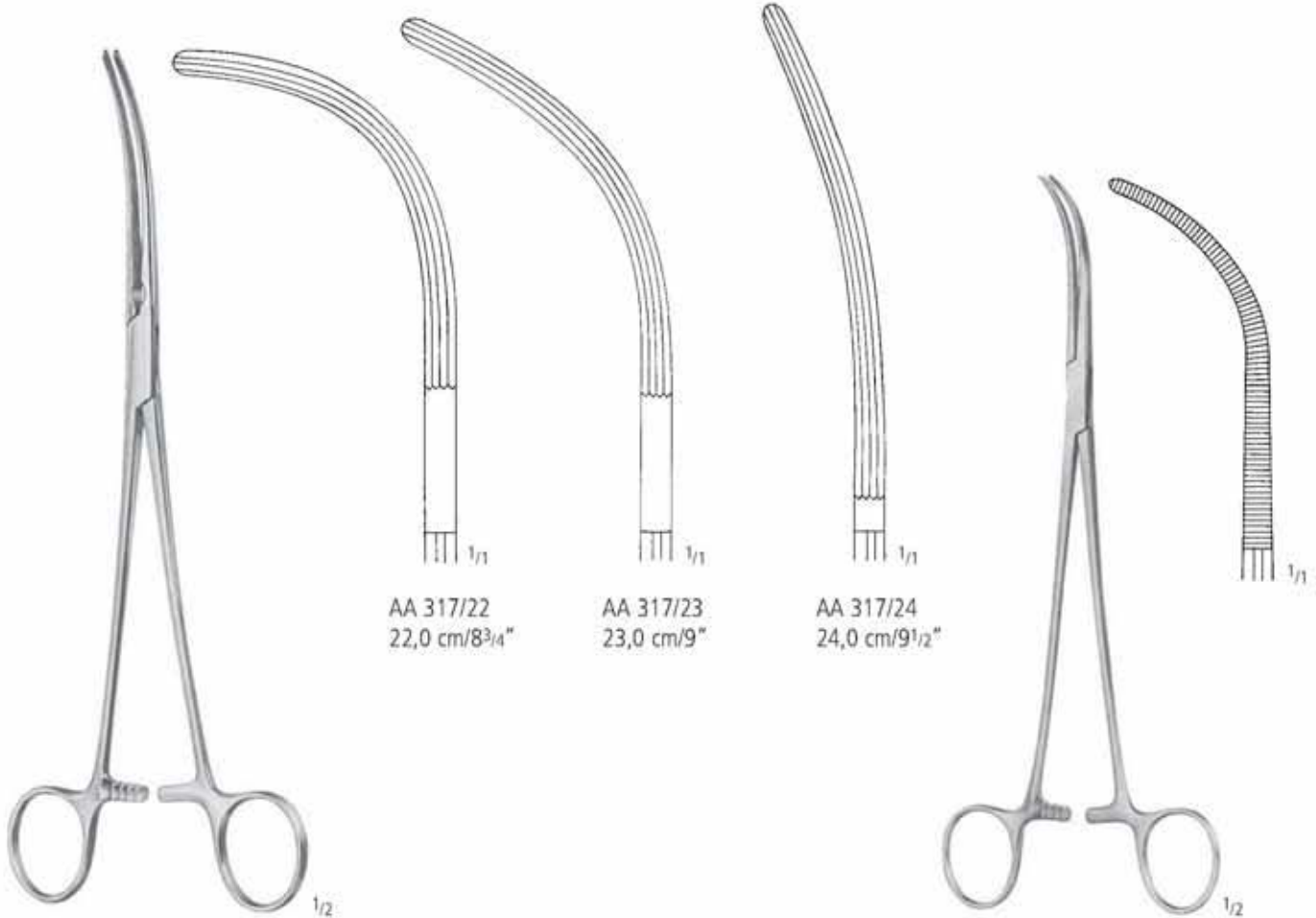

**CRAFOORD-SELLORS**

AA 317/22  
22,0 cm/8<sup>3</sup>/<sub>4</sub>"

AA 317/23  
23,0 cm/9"

AA 317/24  
24,0 cm/9<sup>1</sup>/<sub>2</sub>"

**OVERHOLT-MIXTER**

AA 319/21  
21,0 cm/8<sup>1</sup>/<sub>4</sub>"

**AA** KLEMMEN HEMOSTATS PINZAS HEMOSTATICAS PINCES HEMOSTATIQUES PINZE EMOSTATICHE

Arterienklemmen, Bronchusklemmen  
 Artery Forceps, Bronchus Forceps  
 Pinzas hemostáticas, Pinzas-clamps bronquiales  
 Pincés hémostatiques, Pincés-clamps à bronches  
 Pinze emostatiche, Pinze per bronchi

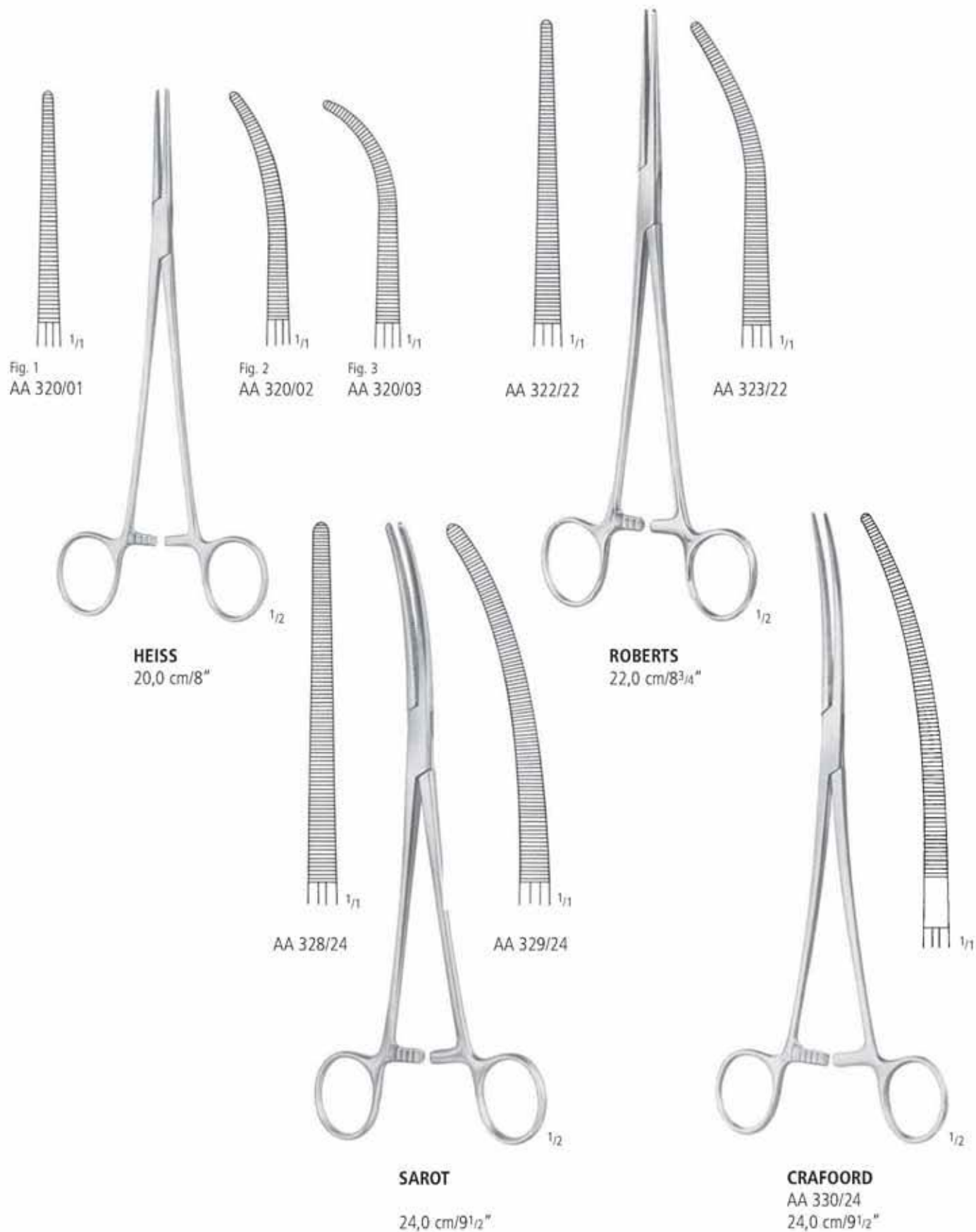

Präparier- und Ligaturklemmen  
 Dissecting and Ligature Forceps  
 Pinzas para preparaciones y ligaduras  
 Pincas à disséquer et à ligatures  
 Pinze per preparazioni e legature

AA

AB

AC

AD

AE

AF

AK

AL

AM

AO

AP

AR

KA

KD

KU

KY



**RUMEL**  
 23,0 cm/9"

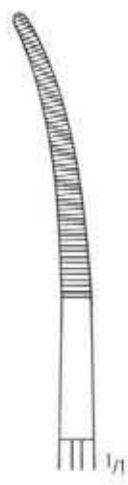

AA 335/01

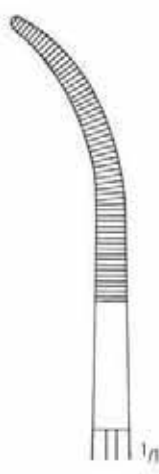

AA 335/02

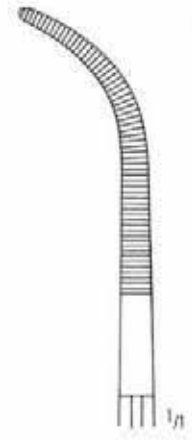

AA 335/03

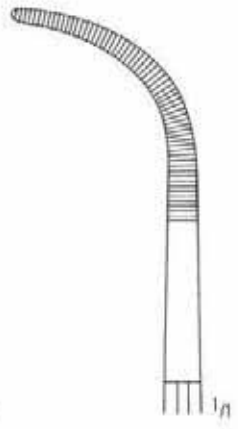

AA 335/04

Präparier- und Ligaturklemmen  
 Dissecting and Ligature Forceps  
 Pinzas para preparaciones y ligaduras  
 Pincès à disséquer et à ligatures  
 Pinze per preparazioni e legature



**JOHNS HOPKINS**  
 AA 338/20  
 20,0 cm/8"

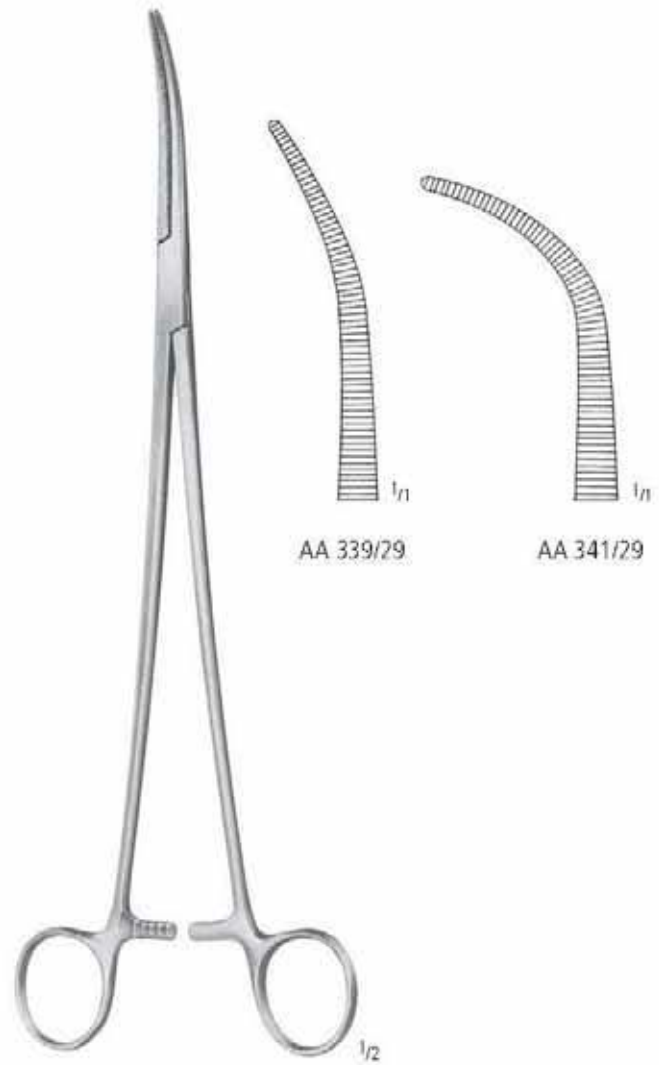

**ZENKER**  
 29,5 cm/11 1/2"



KLEMMEN HEMOSTATS PINZAS HEMOSTATICAS PINCES HEMOSTATIQUES PINZE EMOSTATICHE

Präparier- und Ligaturklemmen  
 Dissecting and Ligature Forceps  
 Pinzas para preparaciones y ligaduras  
 Pincès à disséquer et à ligatures  
 Pinze per preparazioni e legature



**MIXTER**  
 15,5 cm/6"  
 19,0 cm/7½"

AA 345/15  
 AA 345/19



**MIXTER-O'SHAUGNESSY**  
 15,5 cm/6"  
 19,0 cm/7½"

AA 347/15  
 AA 347/19

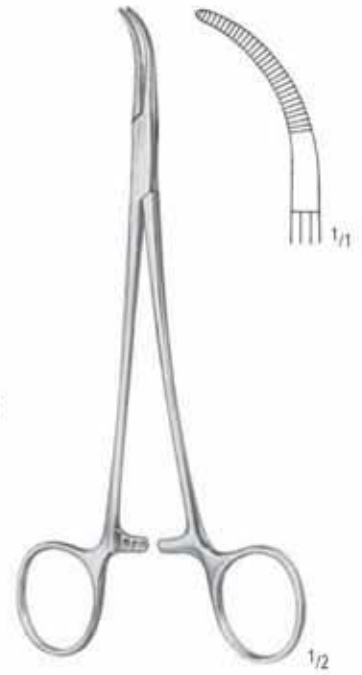

**BABY-MIXTER**  
 18,0 cm/7"

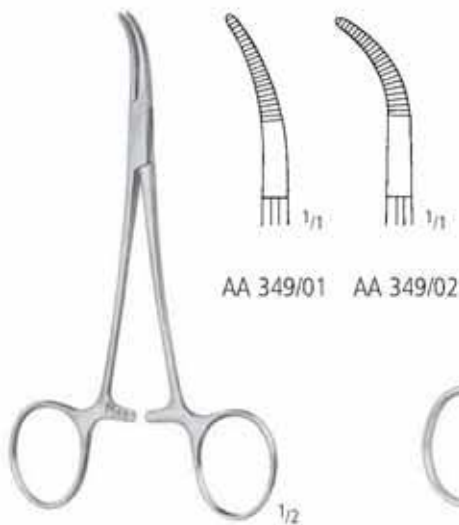

**BABY-MIXTER**  
 14,0 cm/5½"

AA 349/01 AA 349/02



**MIXTER**



Fig. 1  
 AA 353/22  
 22,0 cm/8¾"



Fig. 2  
 AA 353/25  
 25,0 cm/10"

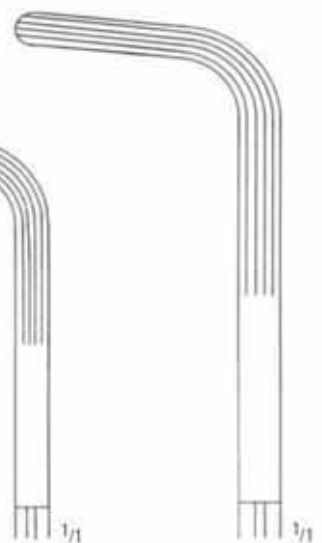
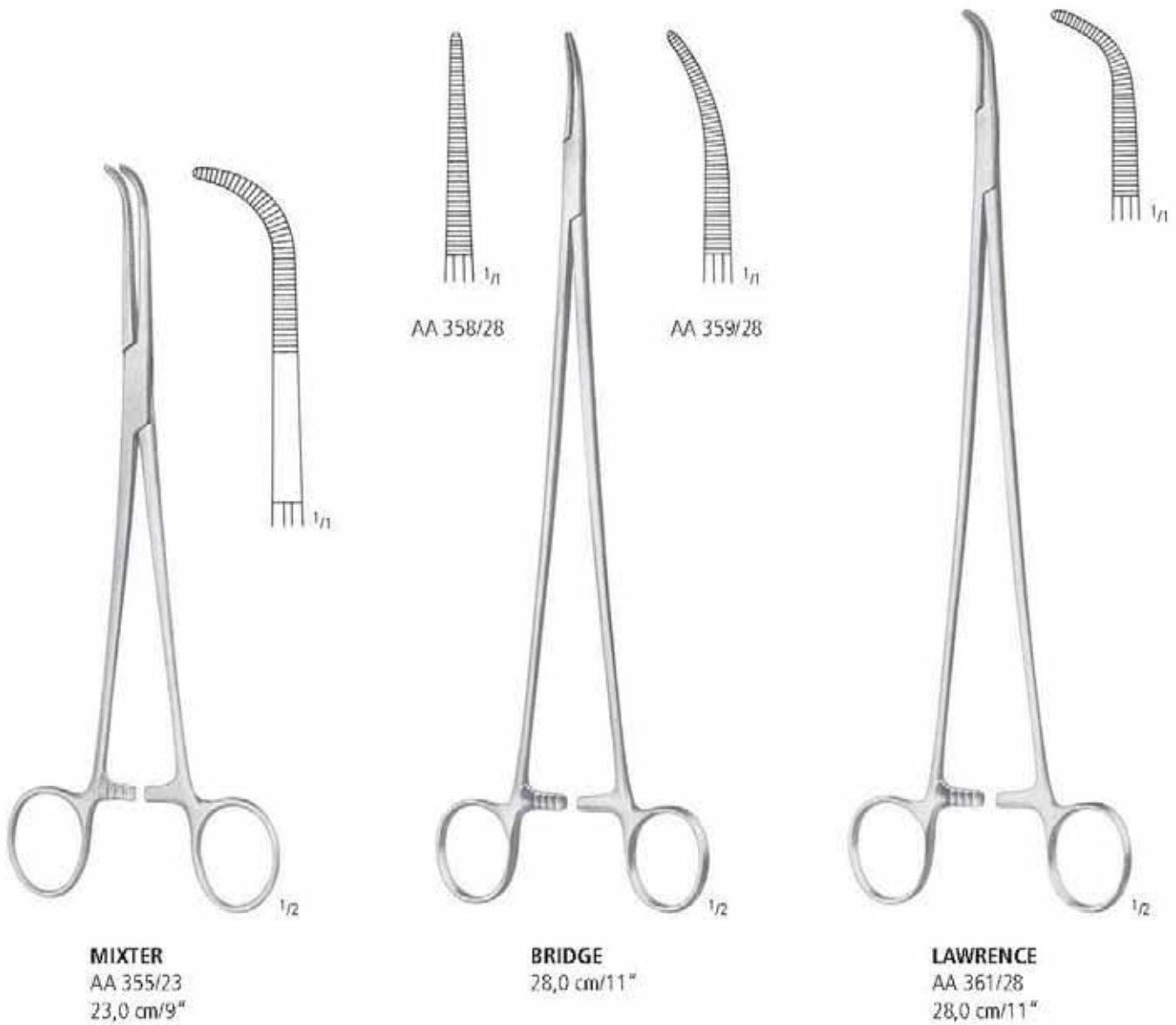

Fig. 3  
 AA 353/28  
 28,0 cm/11"

AA  
 AB  
 AC  
 AD  
 AE  
 AF  
 AK  
 AL  
 AM  
 AO  
 AP  
 AR  
 KA  
 KD  
 KU  
 KY

Präparier- und Ligaturklemmen  
 Dissecting and Ligature Forceps  
 Pinzas para preparaciones y ligaduras  
 Pinces à disséquer et à ligatures  
 Pinze per preparazioni e legature



KLEMMEN HEMOSTATS PINZAS HEMOSTATICAS PINCES HEMOSTATIQUES PINZE EMOSTATICHE

Präparier- und Ligaturklemmen  
 Dissecting and Ligature Forceps  
 Pinzas para preparaciones y ligaduras  
 Pincès à disséquer et à ligatures  
 Pinze per preparazioni e legature

AA  
 AB  
 AC  
 AD  
 AE  
 AF  
 AK  
 AL  
 AM  
 AO  
 AP  
 AR  
 KA  
 KD  
 KU  
 KY



KANTROWITZ

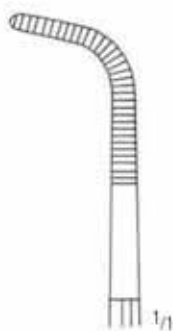

AA 363/20  
20,0 cm/8"

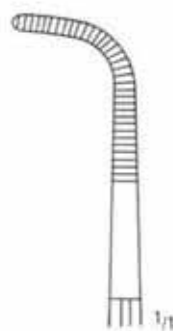

AA 363/24  
24,0 cm/9 1/2"

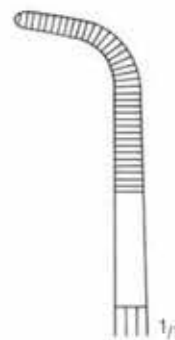

AA 363/28  
28,0 cm/11"



GEMINI

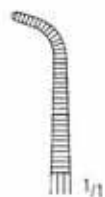

AA 365/14  
14,0 cm/5 1/2"



AA 365/18  
18,0 cm/7"

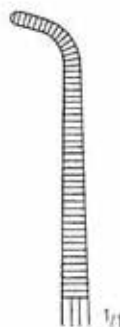

AA 365/22  
22,0 cm/8 3/4"

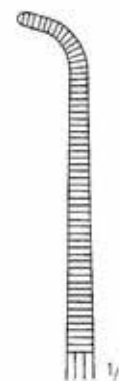

AA 365/25  
25,0 cm/10"



AA 365/28  
28,0 cm/11"

Präparier- und Ligaturklemmen  
 Dissecting and Ligature Forceps  
 Pinzas para preparaciones y ligaduras  
 Pinces à disséquer et à ligatures  
 Pinze per preparazioni e legature

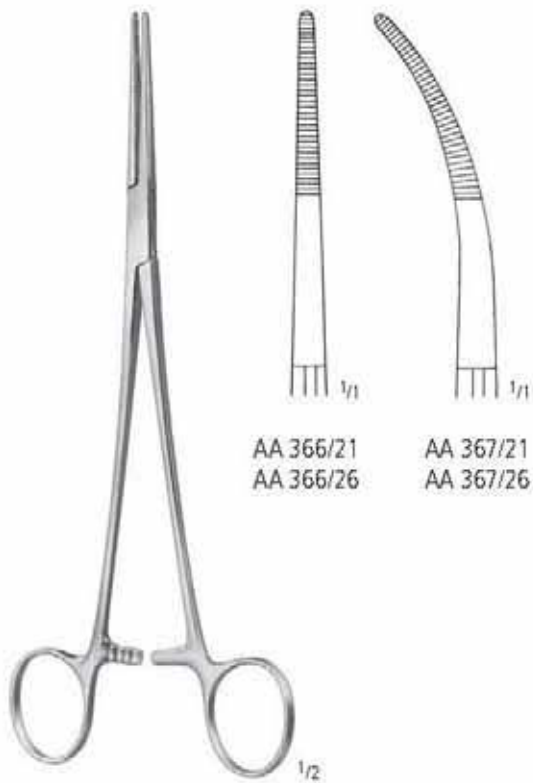

AA 366/21  
 AA 366/26

AA 367/21  
 AA 367/26

**TOENNIS**  
 21,0 cm/8<sup>1</sup>/<sub>4</sub>"  
 26,0 cm/10<sup>1</sup>/<sub>2</sub>"

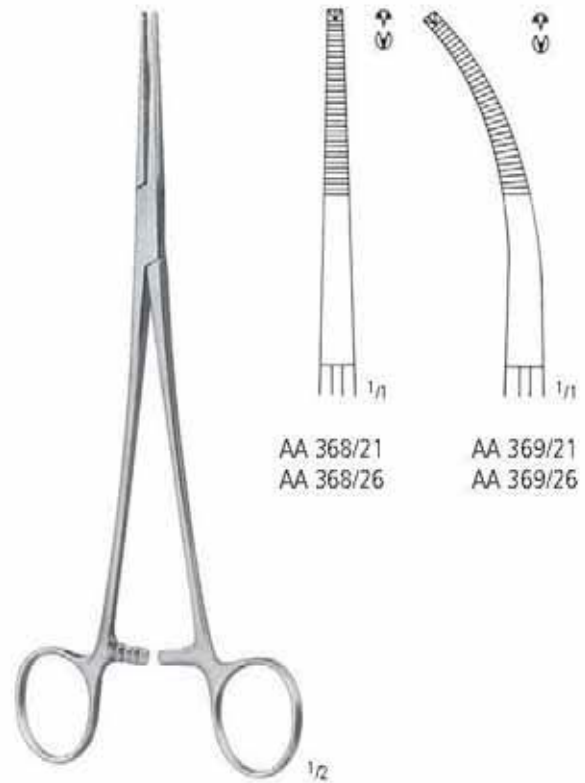

AA 368/21  
 AA 368/26

AA 369/21  
 AA 369/26

**TOENNIS 1:2**  
 21,0 cm/8<sup>1</sup>/<sub>4</sub>"  
 26,0 cm/10<sup>1</sup>/<sub>2</sub>"

Gallenkanal- und Nierenstielklemmen  
 Gall Duct and Kidney Pedicle Clamp Forceps  
 Pinzas-clamps para conducto biliar y pedúnculos renales  
 Pincas-clamps pour voies biliaires et pédicules rénaux  
 Pinze per vie biliari e peduncoli renali

AA

AB

AC

AD

AE

AF

AK

AL

AM

AO

AP

AR

KA

KD

KU

KY



**LAHEY**  
 AA 401/19  
 19,0 cm/7 1/2"

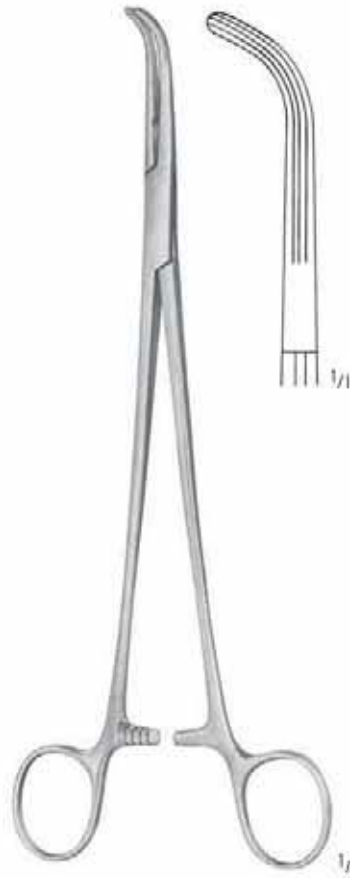

**LAHEY**  
 AA 401/23  
 23,0 cm/9"



**LOWER**  
 AA 403/18  
 18,0 cm/7"

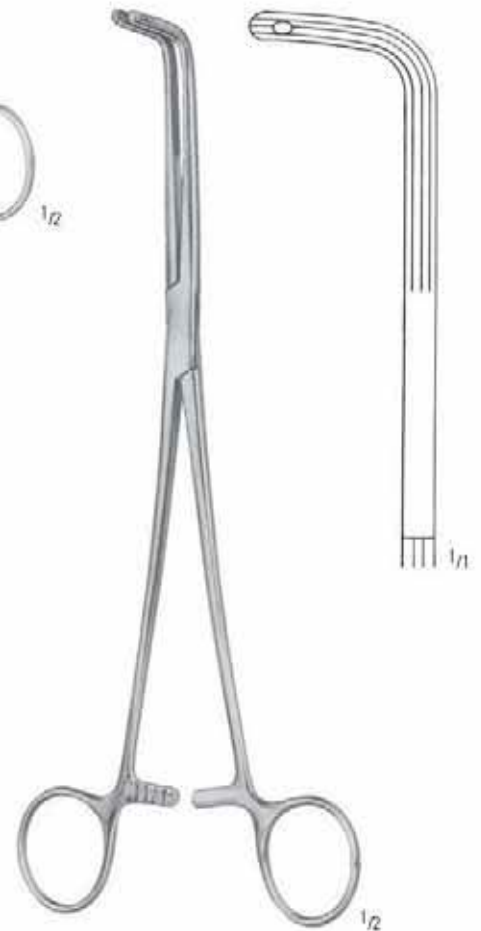

**FINOCCHIETTO**  
 AA 405/24  
 24,0 cm/9 1/2"

Nierenstielklemmen  
 Kidney Pedicle Clamp Forceps  
 Pinzas-clamps para pedúnculos renales  
 Pincas-clamps pour pédicules rénaux  
 Pinze per peduncoli renali

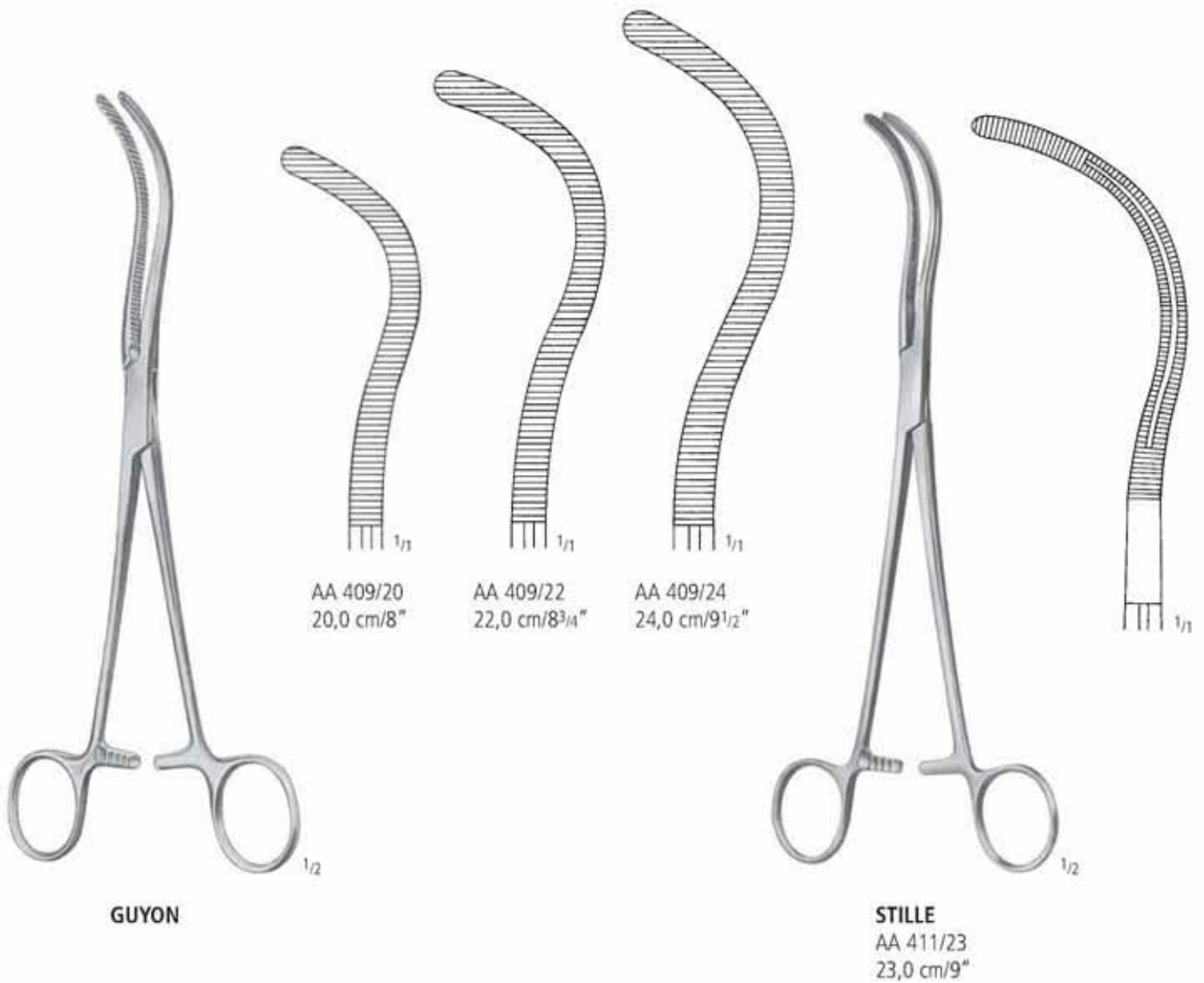



Nierenstielklemmen  
 Kidney Pedicle Clamp Forceps  
 Pinzas-clamps para pedúnculos renales  
 Pincas-clamps pour pédicules rénaux  
 Pinze per peduncoli renali

AA  
 AB  
 AC  
 AD  
 AE  
 AF  
 AG  
 AH  
 AI  
 AJ  
 AK  
 AL  
 AM  
 AN  
 AO  
 AP  
 AQ  
 AR  
 AS  
 AT  
 AU  
 AV  
 AW  
 AX  
 AY  
 AZ  
 BA  
 BB  
 BC  
 BD  
 BE  
 BF  
 BG  
 BH  
 BI  
 BJ  
 BK  
 BL  
 BM  
 BN  
 BO  
 BP  
 BQ  
 BR  
 BS  
 BT  
 BU  
 BV  
 BW  
 BX  
 BY  
 BZ  
 CA  
 CB  
 CC  
 CD  
 CE  
 CF  
 CG  
 CH  
 CI  
 CJ  
 CK  
 CL  
 CM  
 CN  
 CO  
 CP  
 CQ  
 CR  
 CS  
 CT  
 CU  
 CV  
 CW  
 CX  
 CY  
 CZ  
 DA  
 DB  
 DC  
 DD  
 DE  
 DF  
 DG  
 DH  
 DI  
 DJ  
 DK  
 DL  
 DM  
 DN  
 DO  
 DP  
 DQ  
 DR  
 DS  
 DT  
 DU  
 DV  
 DW  
 DX  
 DY  
 DZ  
 EA  
 EB  
 EC  
 ED  
 EE  
 EF  
 EG  
 EH  
 EI  
 EJ  
 EK  
 EL  
 EM  
 EN  
 EO  
 EP  
 EQ  
 ER  
 ES  
 ET  
 EU  
 EV  
 EW  
 EX  
 EY  
 EZ  
 FA  
 FB  
 FC  
 FD  
 FE  
 FF  
 FG  
 FH  
 FI  
 FJ  
 FK  
 FL  
 FM  
 FN  
 FO  
 FP  
 FQ  
 FR  
 FS  
 FT  
 FU  
 FV  
 FW  
 FX  
 FY  
 FZ  
 GA  
 GB  
 GC  
 GD  
 GE  
 GF  
 GG  
 GH  
 GI  
 GJ  
 GK  
 GL  
 GM  
 GN  
 GO  
 GP  
 GQ  
 GR  
 GS  
 GT  
 GU  
 GV  
 GW  
 GX  
 GY  
 GZ  
 HA  
 HB  
 HC  
 HD  
 HE  
 HF  
 HG  
 HH  
 HI  
 HJ  
 HK  
 HL  
 HM  
 HN  
 HO  
 HP  
 HQ  
 HR  
 HS  
 HT  
 HU  
 HV  
 HW  
 HX  
 HY  
 HZ  
 IA  
 IB  
 IC  
 ID  
 IE  
 IF  
 IG  
 IH  
 II  
 IJ  
 IK  
 IL  
 IM  
 IN  
 IO  
 IP  
 IQ  
 IR  
 IS  
 IT  
 IU  
 IV  
 IW  
 IX  
 IY  
 IZ  
 JA  
 JB  
 JC  
 JD  
 JE  
 JF  
 JG  
 JH  
 JI  
 JJ  
 JK  
 JL  
 JM  
 JN  
 JO  
 JP  
 JQ  
 JR  
 JS  
 JT  
 JU  
 JV  
 JW  
 JX  
 JY  
 JZ  
 KA  
 KB  
 KC  
 KD  
 KE  
 KF  
 KG  
 KH  
 KI  
 KJ  
 KK  
 KL  
 KM  
 KN  
 KO  
 KP  
 KQ  
 KR  
 KS  
 KT  
 KU  
 KV  
 KW  
 KX  
 KY  
 KZ  
 LA  
 LB  
 LC  
 LD  
 LE  
 LF  
 LG  
 LH  
 LI  
 LJ  
 LK  
 LL  
 LM  
 LN  
 LO  
 LP  
 LQ  
 LR  
 LS  
 LT  
 LU  
 LV  
 LW  
 LX  
 LY  
 LZ  
 MA  
 MB  
 MC  
 MD  
 ME  
 MF  
 MG  
 MH  
 MI  
 MJ  
 MK  
 ML  
 MM  
 MN  
 MO  
 MP  
 MQ  
 MR  
 MS  
 MT  
 MU  
 MV  
 MW  
 MX  
 MY  
 MZ  
 NA  
 NB  
 NC  
 ND  
 NE  
 NF  
 NG  
 NH  
 NI  
 NJ  
 NK  
 NL  
 NM  
 NN  
 NO  
 NP  
 NQ  
 NR  
 NS  
 NT  
 NU  
 NV  
 NW  
 NX  
 NY  
 NZ  
 OA  
 OB  
 OC  
 OD  
 OE  
 OF  
 OG  
 OH  
 OI  
 OJ  
 OK  
 OL  
 OM  
 ON  
 OO  
 OP  
 OQ  
 OR  
 OS  
 OT  
 OU  
 OV  
 OW  
 OX  
 OY  
 OZ  
 PA  
 PB  
 PC  
 PD  
 PE  
 PF  
 PG  
 PH  
 PI  
 PJ  
 PK  
 PL  
 PM  
 PN  
 PO  
 PP  
 PQ  
 PR  
 PS  
 PT  
 PU  
 PV  
 PW  
 PX  
 PY  
 PZ  
 QA  
 QB  
 QC  
 QD  
 QE  
 QF  
 QG  
 QH  
 QI  
 QJ  
 QK  
 QL  
 QM  
 QN  
 QO  
 QP  
 QQ  
 QR  
 QS  
 QT  
 QU  
 QV  
 QW  
 QX  
 QY  
 QZ  
 RA  
 RB  
 RC  
 RD  
 RE  
 RF  
 RG  
 RH  
 RI  
 RJ  
 RK  
 RL  
 RM  
 RN  
 RO  
 RP  
 RQ  
 RR  
 RS  
 RT  
 RU  
 RV  
 RW  
 RX  
 RY  
 RZ  
 SA  
 SB  
 SC  
 SD  
 SE  
 SF  
 SG  
 SH  
 SI  
 SJ  
 SK  
 SL  
 SM  
 SN  
 SO  
 SP  
 SQ  
 SR  
 SS  
 ST  
 SU  
 SV  
 SW  
 SX  
 SY  
 SZ  
 TA  
 TB  
 TC  
 TD  
 TE  
 TF  
 TG  
 TH  
 TI  
 TJ  
 TK  
 TL  
 TM  
 TN  
 TO  
 TP  
 TQ  
 TR  
 TS  
 TT  
 TU  
 TV  
 TW  
 TX  
 TY  
 TZ  
 UA  
 UB  
 UC  
 UD  
 UE  
 UF  
 UG  
 UH  
 UI  
 UJ  
 UK  
 UL  
 UM  
 UN  
 UO  
 UP  
 UQ  
 UR  
 US  
 UT  
 UY  
 UZ  
 VA  
 VB  
 VC  
 VD  
 VE  
 VF  
 VG  
 VH  
 VI  
 VJ  
 VK  
 VL  
 VM  
 VN  
 VO  
 VP  
 VQ  
 VR  
 VS  
 VT  
 VY  
 VZ  
 WA  
 WB  
 WC  
 WD  
 WE  
 WF  
 WG  
 WH  
 WI  
 WJ  
 WK  
 WL  
 WM  
 WN  
 WO  
 WP  
 WQ  
 WR  
 WS  
 WT  
 WY  
 WZ  
 XA  
 XB  
 XC  
 XD  
 XE  
 XF  
 XG  
 XH  
 XI  
 XJ  
 XK  
 XL  
 XM  
 XN  
 XO  
 XP  
 XQ  
 XR  
 XS  
 XT  
 XU  
 XV  
 XW  
 XX  
 XY  
 XZ  
 YA  
 YB  
 YC  
 YD  
 YE  
 YF  
 YG  
 YH  
 YI  
 YJ  
 YK  
 YL  
 YM  
 YN  
 YO  
 YP  
 YQ  
 YR  
 YS  
 YT  
 YZ  
 ZA  
 ZB  
 ZC  
 ZD  
 ZE  
 ZF  
 ZG  
 ZH  
 ZI  
 ZJ  
 ZK  
 ZL  
 ZM  
 ZN  
 ZO  
 ZP  
 ZQ  
 ZR  
 ZS  
 ZT  
 ZY  
 ZZ



**GUYON**  
 AA 413/23  
 23,0 cm/9"

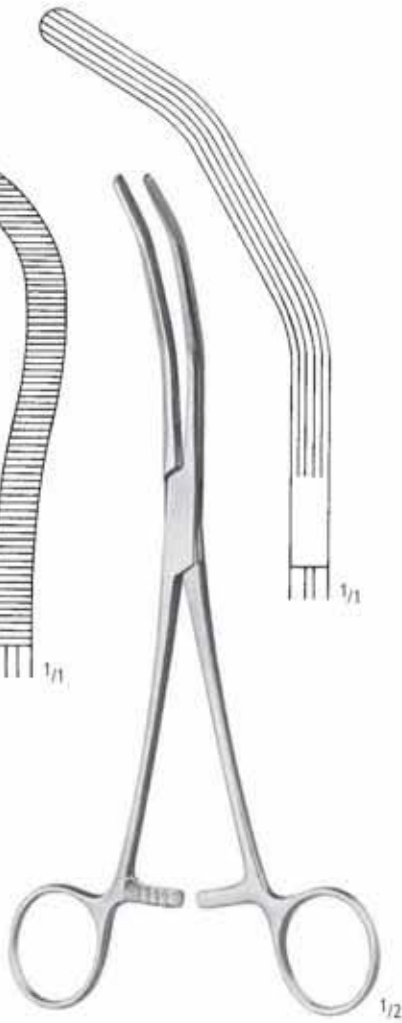

**HERRICK**  
 AA 417/23  
 23,0 cm/9"



**GUYON-ARTRAUMATIC**

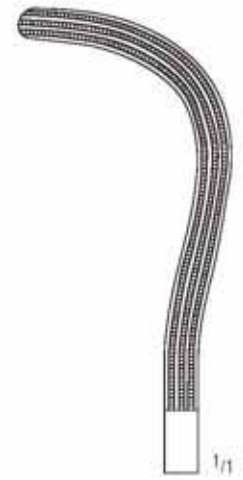

AA 419/23  
 23,0 cm/9"

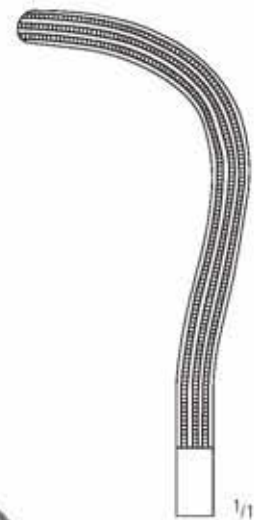

AA 419/24  
 24,0 cm/9 1/2"

Gallenkanalklemmen  
 Gall Duct Forceps  
 Pinzas-clamps para conducto biliar  
 Pincers-clamps pour voies biliaires  
 Pinze per vie biliari

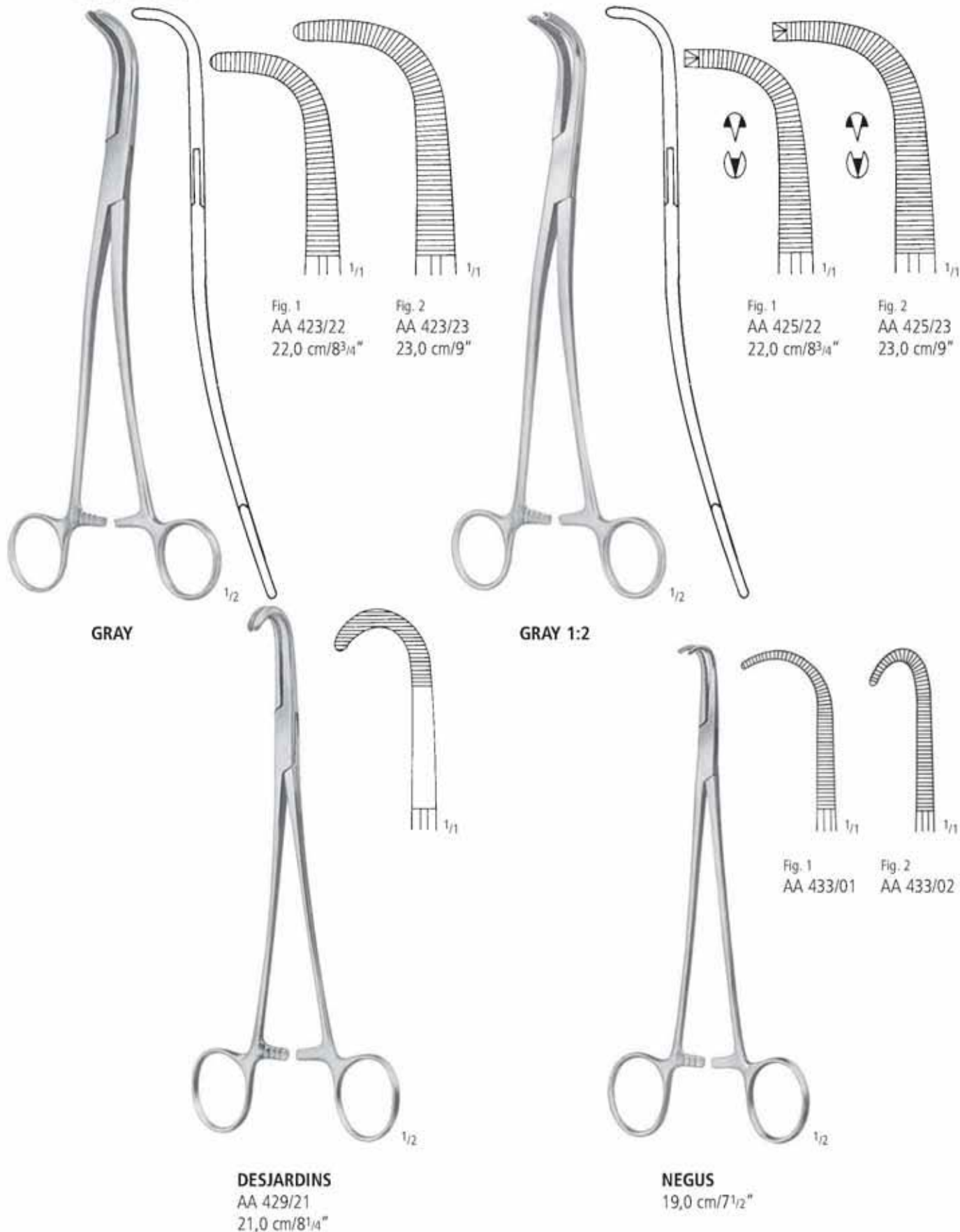

KLEMMEN HEMOSTATS PINZAS HEMOSTATICAS PINCES HEMOSTATIQUES PINZE EMOSTATICHE

Präparier- und Ligaturklemmen, Hysterektomieklappen  
 Dissecting and Ligature Forceps, Hysterectomy Forceps  
 Pinzas para preparaciones y ligaduras, Pinzas-clamps para histerectomía  
 Pincès à disséquer et à ligatures, Pincès à hystérectomie  
 Pinze per preparazioni e legature, Pinze per isterectomia

AA

AB

AC

AD

AE

AF

AK

AL

AM

AO

AP

AR

KA

KD

KU

KY

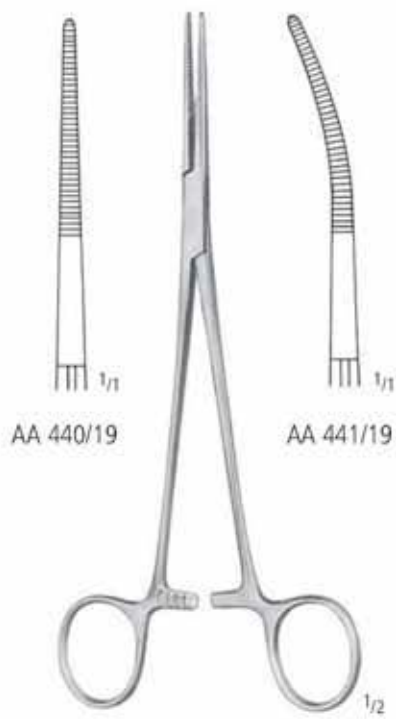

**BIRKETT**  
 19,0 cm/7 1/2"



**WIKSTROEM**  
 AA 443/19  
 19,0 cm/7 1/2"

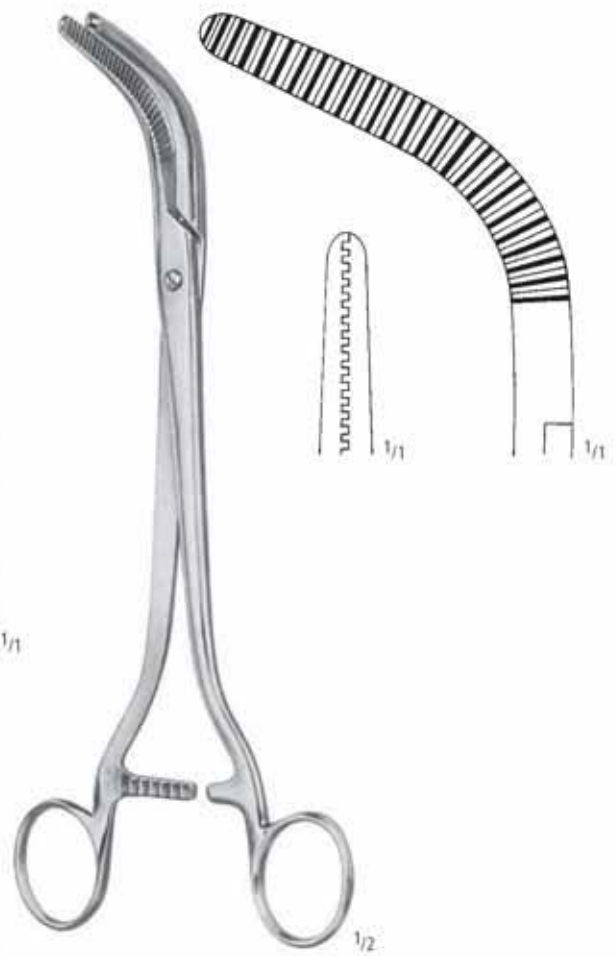

**WERTHEIM**  
 AA 500/27  
 27,0 cm/10 3/4"

Hysterektomieklemmen  
 Hysterectomy Forceps  
 Pinzas-damps para histerectomía  
 Pinces à hystérectomie  
 Pinze per isterectomia

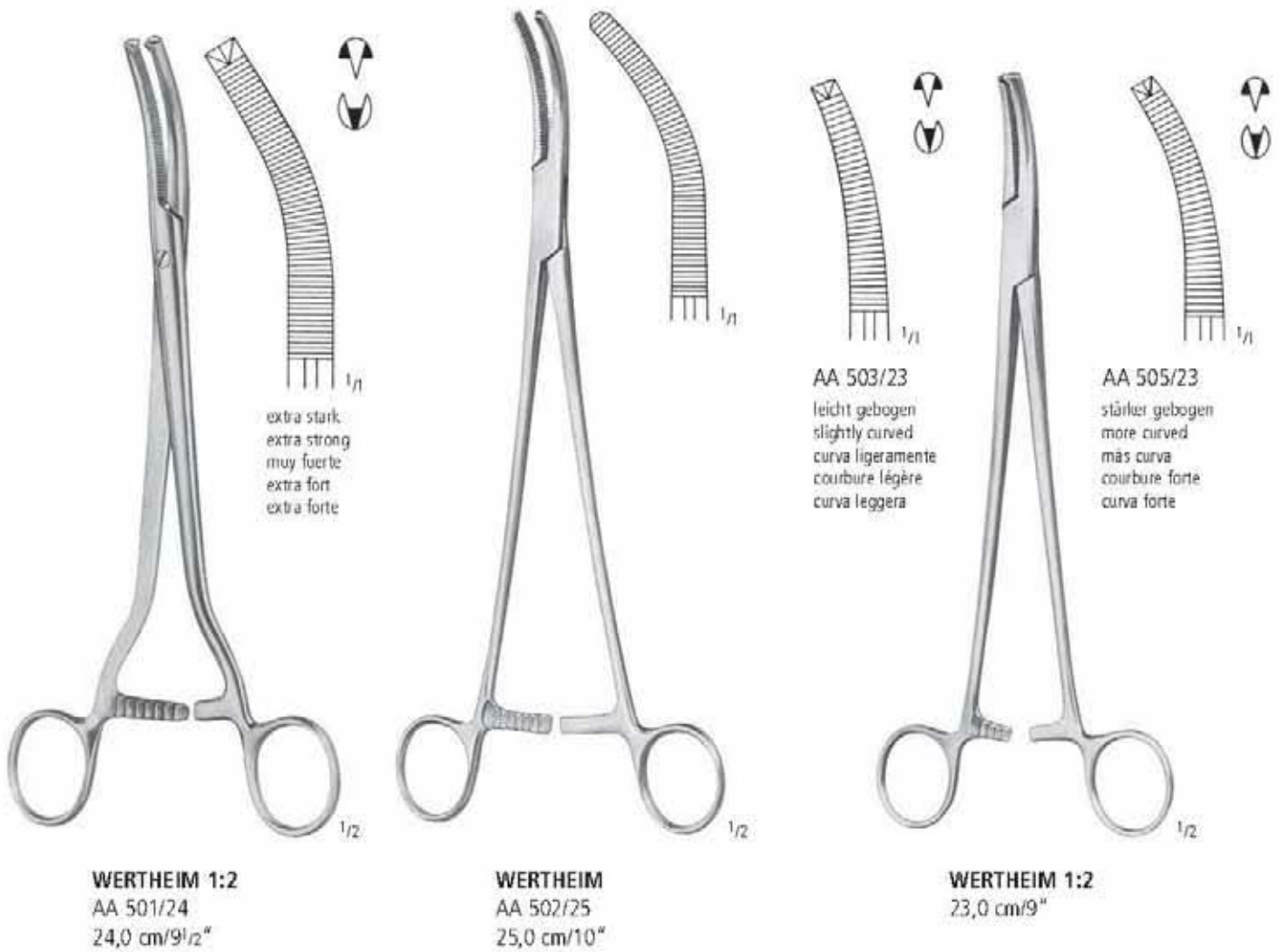

Hysterektomieklemmen  
Hysterectomy Forceps  
Pinzas-clamps para histerectomia  
Pincas à hystérectomie  
Pinze per isterectomia

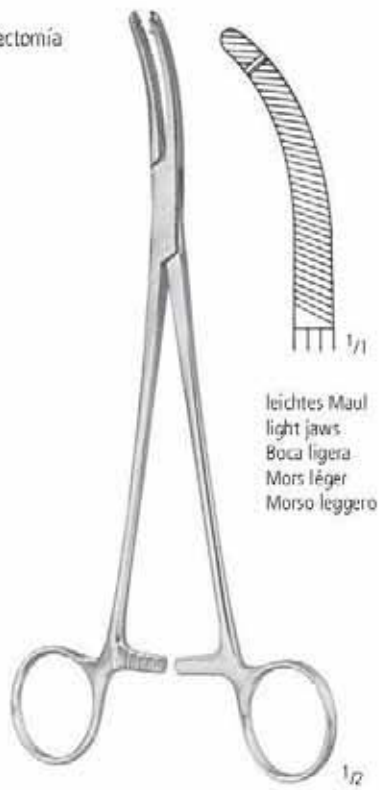

leichtes Maul  
light jaws  
Boca ligera  
Mors léger  
Morso leggero

**HEANEY**  
AA 507/21  
21,0 cm/8<sup>1</sup>/<sub>4</sub>"

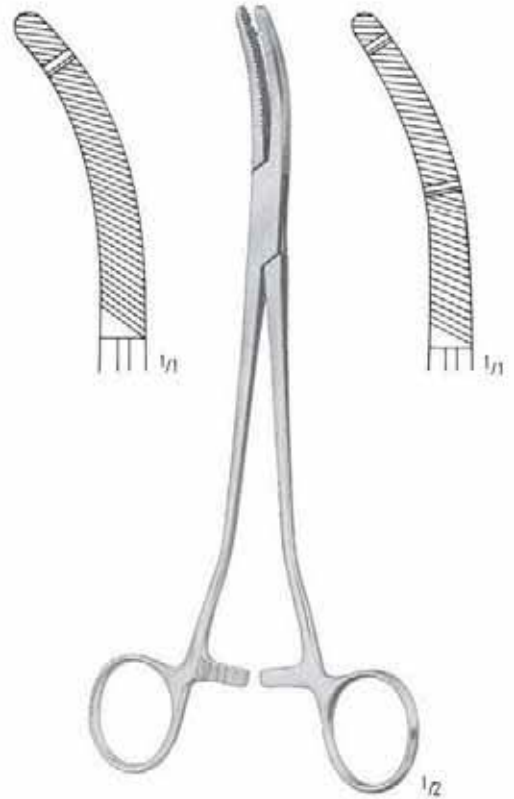

**HEANEY**  
AA 511/21 21,0 cm/8<sup>1</sup>/<sub>4</sub>" AA 513/21  
AA 511/23 23,0 cm/9" AA 513/23

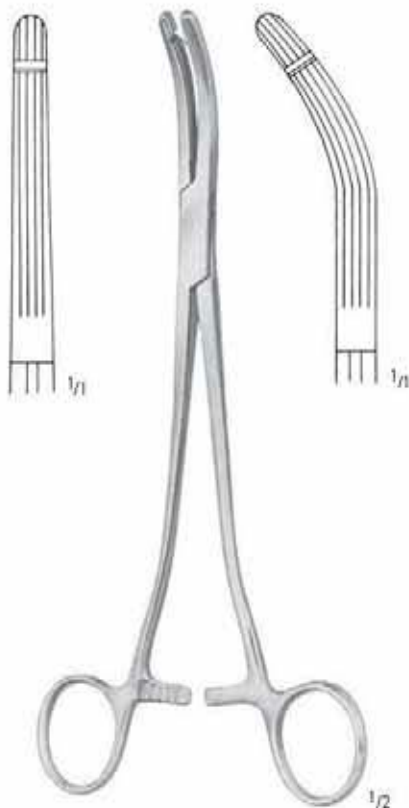

**HEANEY-BALLANTINE**  
AA 514/21 21,0 cm/8<sup>1</sup>/<sub>4</sub>" AA 515/21

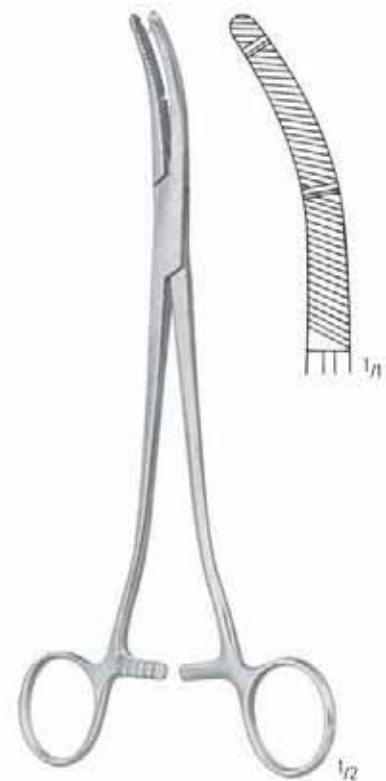

**HEANEY-KANTER**  
AA 517/21  
21,0 cm/8<sup>1</sup>/<sub>4</sub>"

AA  
AB  
AC  
AD  
AE  
AF  
AK  
AL  
AM  
AO  
AP  
AR  
KA  
KD  
KU  
KY



**AA** KLEMMEN HEMOSTATS PINZAS HEMOSTATICAS PINCES HEMOSTATIQUES PINZE EMOSTATICHE

Hysterektomieklemmen  
 Hysterectomy Forceps  
 Pinzas-clamps para histerectomía  
 Pincés à hystérectomie  
 Pinze per isterectomia



**HEANEY-REZAK**  
 AA 519/21  
 21,0 cm/8<sup>1</sup>/<sub>4</sub>"

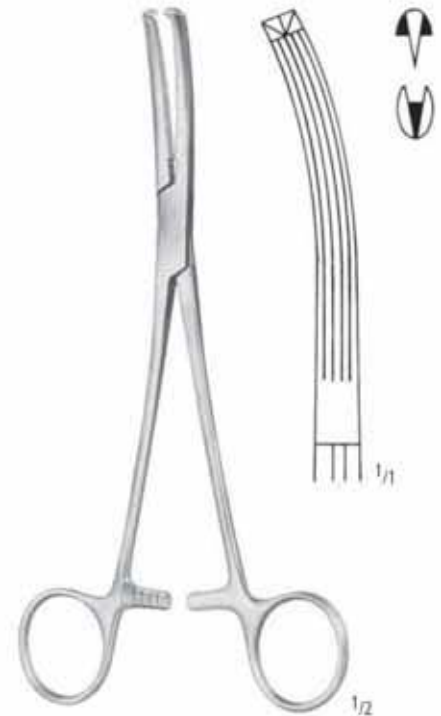

**LONG**  
 AA 521/19  
 19,0 cm/7<sup>1</sup>/<sub>2</sub>"



**MOYNIHAN**

AA 525/23  
 23,0 cm/9"

AA 527/24  
 24,0 cm/9<sup>1</sup>/<sub>2</sub>"



**WERTHEIM-CULLEN**  
 AA 529/21  
 21,5 cm/8<sup>1</sup>/<sub>2</sub>"



Hysterektomieklemmen  
 Hysterectomy Forceps  
 Pinzas-clamps para histerectomía  
 Pincés à hystérectomie  
 Pinze per isterectomia

AA

AB

AC

AD

AE

AF

AK

AL

AM

AO

AP

AR

KA

KD

KU

KY

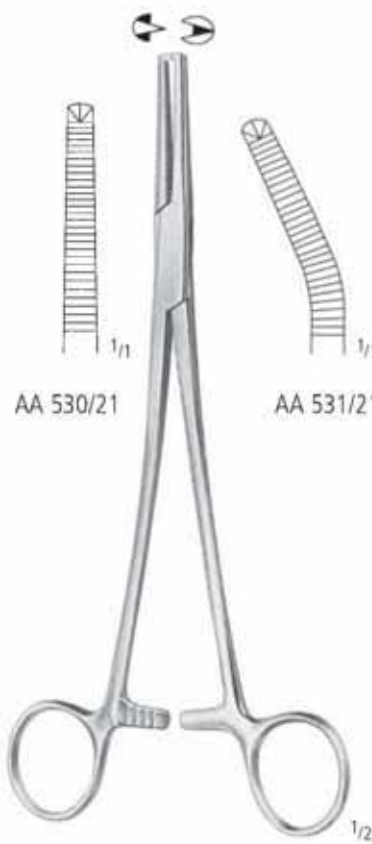

AA 530/21

AA 531/21

**PHANEUF 1:2**  
 21,5 cm/8 1/2"

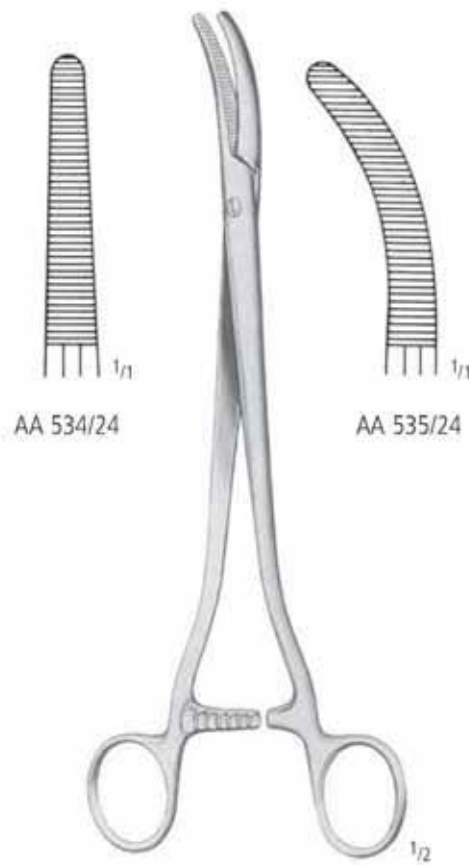

AA 534/24

AA 535/24

**SEGOND-LANDAU**  
 24,0 cm/9 1/2"

**SEGOND**  
 24,0 cm/9 1/2"

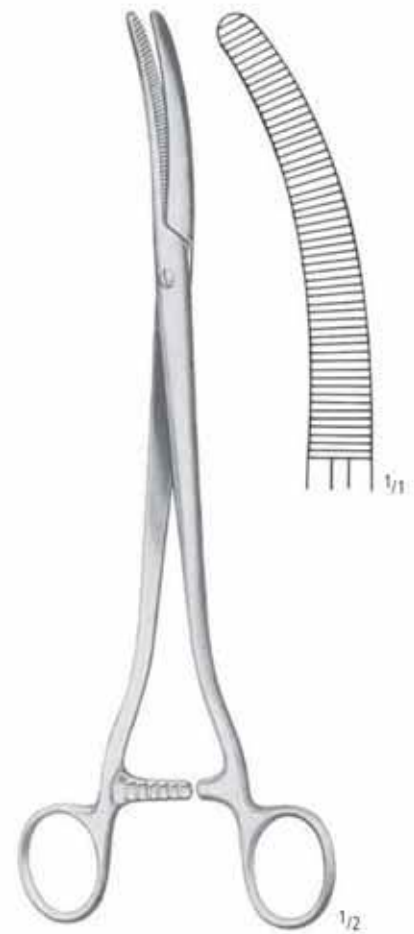

**FAURE**  
 AA 537/25  
 25,0 cm/10"

Parametriumklemmen  
 Parametrium Forceps  
 Pinzas-damps para parametrium  
 Pincas-clamps pour parametrium  
 Pinze per parametrium



**PARAMETRIUM**  
 21,0 cm/8<sup>1</sup>/<sub>4</sub>"

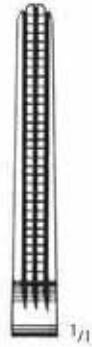

AA 540/00



AA 541/01



AA 541/02



AA 541/03

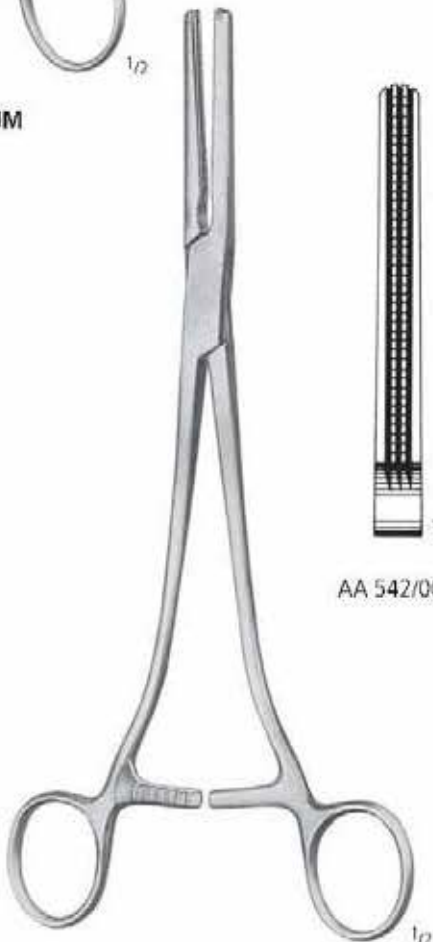

**PARAMETRIUM**  
 24,0 cm/9<sup>1</sup>/<sub>2</sub>"

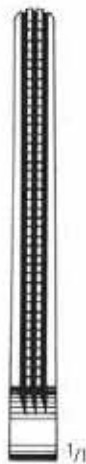

AA 542/00



AA 543/01

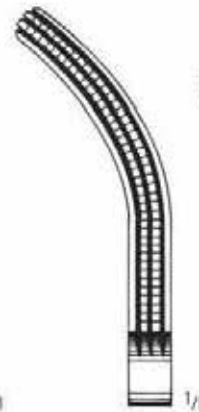

AA 543/02



AA 543/03

KLEMMEN HEMOSTATS PINZAS HEMOSTATICAS PINCES HEMOSTATIQUES PINZE EMOSTATICHE

Druckklemmen, Hämorrhoidenklemmen  
 Angiotribes, Haemorrhoidal Forceps  
 Pinzas-clamps de presión progresiva, Pinzas hemorroidales  
 Pince-clamps à pression progressive et à hémorroïdes  
 Pinze per pressione progressiva e per emorroidi

AA

AB

AC

AD

AE

AF

AK

AL

AM

AO

AP

AR

KA

KD

KU

KY



**FERGUSSON**

AA 550/16  
 AA 550/20

16,0 cm/6 1/4"  
 20,0 cm/8"

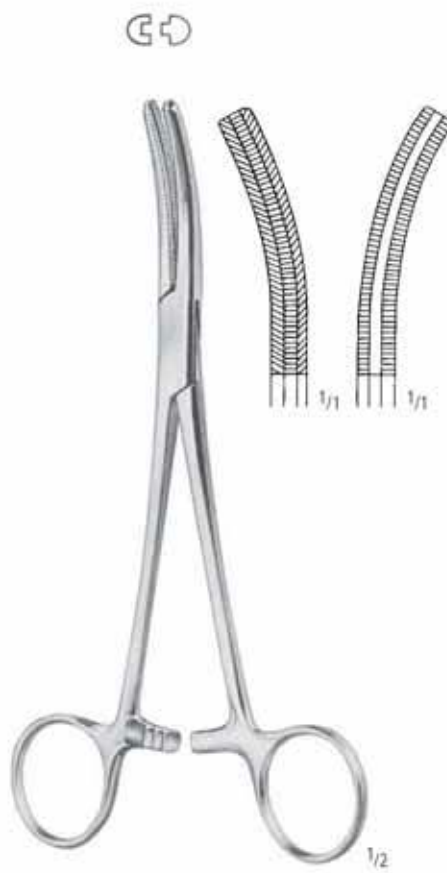

**FERGUSSON**

AA 551/16  
 AA 551/20



**PRATT**

AA 556/15  
 15,0 cm/6"

Druckklemmen, Hämorrhoidenklemmen  
 Angiotribes, Haemorrhoidal Forceps  
 Pinzas-clamps de presión progresiva, Pinzas hemorroidales  
 Pincers-clamps à pression progressive et à hémorroïdes  
 Pinze per pressione progressiva e per emorroidi

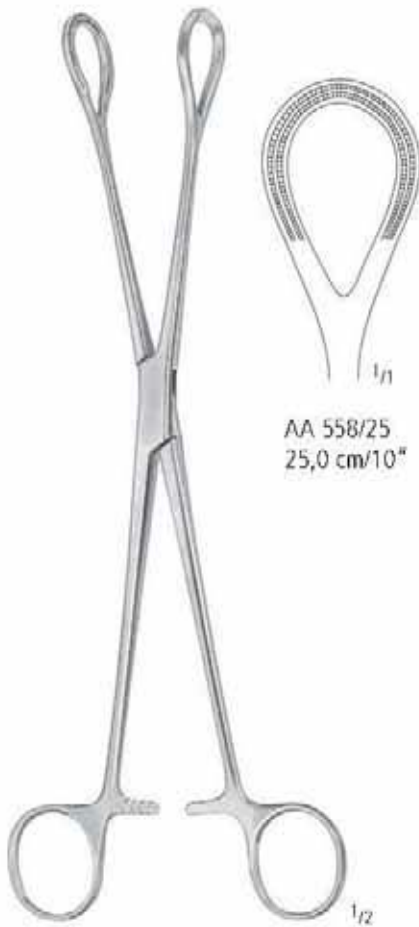

AA 558/25  
 25,0 cm/10"



AA 558/27  
 27,0 cm/10<sup>3</sup>/<sub>4</sub>"

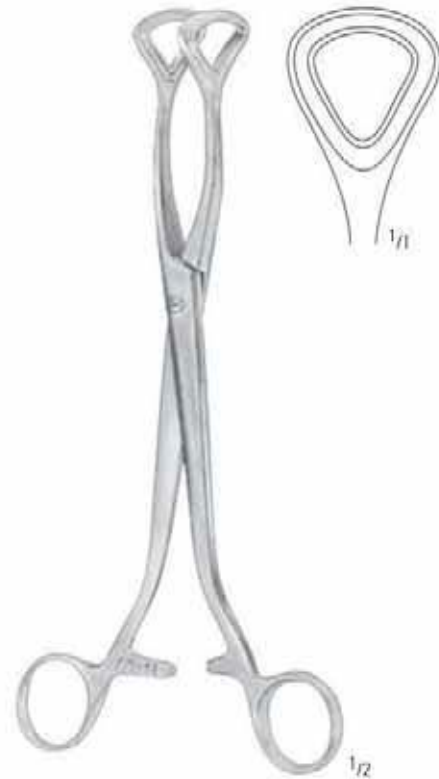

LUER  
 AA 560/24  
 24,0 cm/9<sup>1</sup>/<sub>2</sub>"

KLEMMEN HEMOSTATS PINZAS HEMOSTATICAS PINCES HEMOSTATIQUES PINZE EMOSTATICHE

Peritoneumklemmen  
 Peritoneal Clamp Forceps  
 Pinzas-clamps para peritoneo  
 Pincas-clamps pour le péritoine  
 Pinze per peritoneo

AA

AB

AC

AD

AE

AF

AK

AL

AM

AO

AP

AR

KA

KD

KU

KY

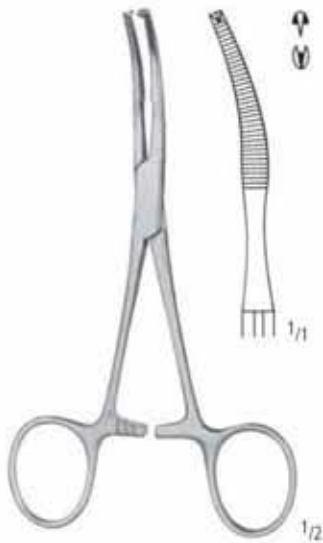

**BABY-MIKULICZ 1:2**  
 AA 601/14  
 14,0 cm/5 1/2"



**MIKULICZ 1:2**  
 AA 603/18  
 18,0 cm/7"



AA 605/20



AA 607/20

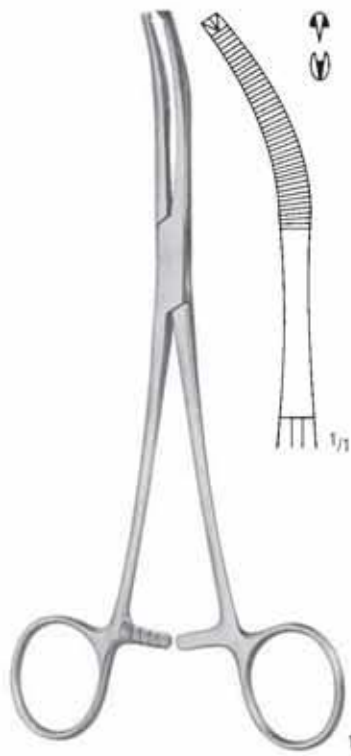

**MIKULICZ 1:2**  
 AA 609/20  
 20,0 cm/8"

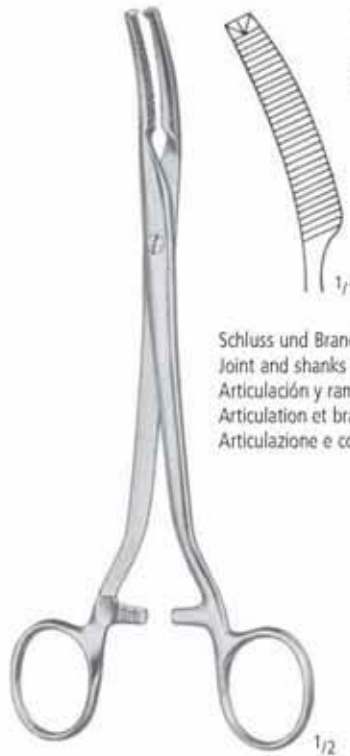

**MIKULICZ 1:2**  
 AA 611/20  
 20,5 cm/8"

Schluss und Branchen extra stark  
 Joint and shanks extra strong  
 Articulación y ramas muy fuerte  
 Articulation et branches très fortes  
 Articolazione e corpo molto robusto



**MIKULICZ 1:2**  
 AA 613/23  
 23,0 cm/9"

Peritoneumklemmen  
 Peritoneal Clamp Forceps  
 Pinzas-clamps para peritoneo  
 Pincres-clamps pour le péritoine  
 Pinze per peritoneo



AA 621/20  
 leicht gebogen  
 slightly curved  
 curva ligeramente  
 courbure légère  
 curva leggera

**FAURE 1:2**  
 20,0 cm/8"



AA 623/20  
 stärker gebogen  
 more curved  
 más curva  
 courbure forte  
 curva forte



**SCHINDLER 1:2**  
 AA 625/20  
 20,0 cm/8"



Tuchklemmen  
Towel Forceps  
Pinzas para compresas, Pinzas de campo  
Pincas à champs, Pincas à compresses  
Pinze per fissare le compresse (Fissatele)

AA

AB

AC

AD

AE

AF

AK

AL

AM

AO

AP

AR

KA

KD

KU

KY



**SCHAEDEL**  
AA 710/09  
9,0 cm/3 1/2"



**JONES**  
5,0 cm/2" AA 711/05  
9,0 cm/3 1/2" AA 711/09



**ENGL. MODELL**  
AA 717/09  
9,0 cm/3 1/2"



**DOYEN**  
AA 721/18  
18,0 cm/7"



**BERNHARD**  
AA 726/16  
16,5 cm/6 1/2"



**LANE**  
15,0 cm/6" AA 730/15  
18,0 cm/7" AA 730/18  
20,0 cm/8" AA 730/20

Tuchklemmen  
Towel Forceps  
Pinzas para compresas, Pinzas de campo  
Pincers à champs, Pincers à compresas  
Pinze per fissare le compresse (Fissatele)



**AA 749/11**

11,0 cm/4<sup>1</sup>/<sub>3</sub>"

- mit Schlauch- oder Kabelhalter
- with clip for tubing or cable
- con porta-tubo o porta-cable
- avec clamp porte-tube ou porte-coton d'alimentation
- con porta tubo o porta cavo



**BACKHAUS**

- |   |           |
|---|-----------|
| 8,0 cm/3"                               | AA 751/08 |
| 11,0 cm/4 <sup>1</sup> / <sub>3</sub> " | AA 751/11 |
| 13,0 cm/5"                              | AA 751/13 |
| 15,0 cm/6"                              | AA 751/15 |



**BALL & SOCKET**

- |   |           |
|---|-----------|
| 11,0 cm/4 <sup>1</sup> / <sub>3</sub> " | AA 753/11 |
| 13,0 cm/5"                              | AA 753/13 |

für Papiertücher  
for paper tissues  
para servilletas de papel  
pour serviettes en papier  
per tessuti di carta



**ROEDER**

- |            |           |
|------------|-----------|
| 13,0 cm/5" | AA 761/13 |
| 15,0 cm/6" | AA 761/15 |



**LORNA**

- |            |           |
|------------|-----------|
| 10,0 cm/4" | AA 763/10 |
| 13,0 cm/5" | AA 763/13 |



**TOHOKU-JAPAN**

- |            |           |
|------------|-----------|
| 10,0 cm/4" | AA 764/10 |
| 13,0 cm/5" | AA 764/13 |



**PEERS**

- |   |
|---|
| AA 765/14                               |
| 14,5 cm/5 <sup>3</sup> / <sub>4</sub> " |

Schlauchklemmen  
Tubing Clamps  
Pinzas para tubos  
Presses-tube  
Pinze serratubi

AA

AB

AC

AD

AE

AF

AK

AL

AM

AO

AP

AR

KA

KD

KU

KY

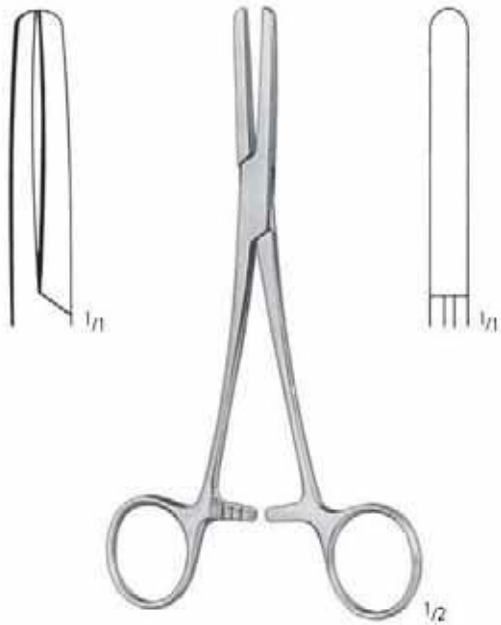

**PRESBYTERIAN**

16,5 cm/6 1/2" AA 790/16  
18,0 cm/7" AA 790/18



**KLINIKUM BERLIN**

AA 792/14  
14,5 cm/5 3/4"  
mit langer Sperre  
with long ratchet  
con cremallera larga  
à crémaillère extra longue  
con cremagliera extra lunga



AA 794/15  
AA 794/18  
AA 794/20

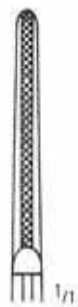

AA 794/15

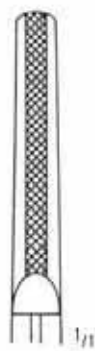

AA 794/18



AA 794/20

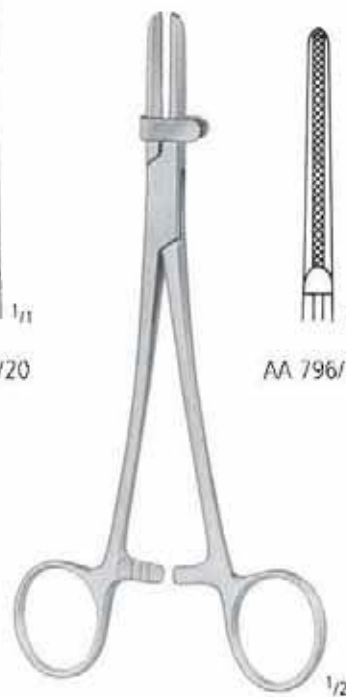

AA 796/15  
AA 796/18  
AA 796/20

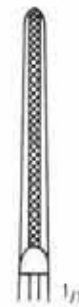

AA 796/15

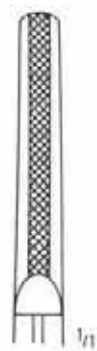

AA 796/18



AA 796/20



---

PINZETTEN  
FORCEPS  
PINZAS  
PINCES  
PINZE

**AB**

**nopa**<sup>®</sup> instruments















PINZETTEN FORCEPS PINZAS PINCES PINZE

Anatomische Pinzetten, Chirurgische Pinzetten  
 Dressing forceps, Tissue Forceps  
 Pinzas de disección, Pinzas de disección con dientes  
 Pincers à dissection, Pincers à griffes  
 Pinze anatomiche per dissezione, Pinze chirurgiche a denti di topo



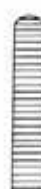

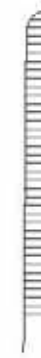







**STANDARD**

				
AB 050/10 10,5 cm/4 <sup>1</sup> / <sub>4</sub> "	AB 050/11 11,5 cm/4 <sup>1</sup> / <sub>2</sub> "	AB 050/13 13,0 cm/5"	AB 050/14 14,5 cm/5 <sup>3</sup> / <sub>4</sub> "	AB 050/16 16,0 cm/6 <sup>1</sup> / <sub>4</sub> "
				
AB 050/18 18,0 cm/7"	AB 050/20 20,0 cm/8"	AB 050/25 25,0 cm/10"	AB 050/30 30,0 cm/12"	AB 050/36 36,0 cm/14"



**STANDARD 1:2**

				
AB 060/10 10,5 cm/4 <sup>1</sup> / <sub>4</sub> "	AB 060/11 11,5 cm/4 <sup>1</sup> / <sub>2</sub> "	AB 060/13 13,0 cm/5"	AB 060/14 14,5 cm/5 <sup>3</sup> / <sub>4</sub> "	AB 060/16 16,0 cm/6 <sup>1</sup> / <sub>4</sub> "
				
AB 060/18 18,0 cm/7"	AB 060/20 20,0 cm/8"	AB 060/25 25,0 cm/10"	AB 060/30 30,0 cm/12"	AB 060/36 36,0 cm/14"

AA  
AB  
AC  
AD  
AE  
AF  
AK  
AL  
AM  
AO  
AP  
AR  
KA  
KD  
KY

**AB** PINZETTEN FORCEPS PINZAS PINCES PINZE

Anatomische Pinzetten, Chirurgische Pinzetten  
 Dressing Forceps, Tissue Forceps  
 Pinzas de disección, Pinzas de disección con dientes  
 Pincas à dissection, Pincas à griffes  
 Pinze anatomiche per dissezione, Pinze chirurgiche a denti di topo



AB 062/14

2:3

- 13,0 cm/5"
- 14,5 cm/5<sup>3</sup>/<sub>4</sub>"
- 16,0 cm/6<sup>1</sup>/<sub>4</sub>"
- 18,0 cm/7"
- 20,0 cm/8"
- 25,0 cm/10"
- 30,0 cm/12"

- AB 062/13
- AB 062/14
- AB 062/16
- AB 062/18
- AB 062/20
- AB 062/25
- AB 062/30



AB 064/14

3:4

- AB 064/13
- AB 064/14
- AB 064/16



AB 066/14

4:5

- AB 066/13
- AB 066/14
- AB 066/16

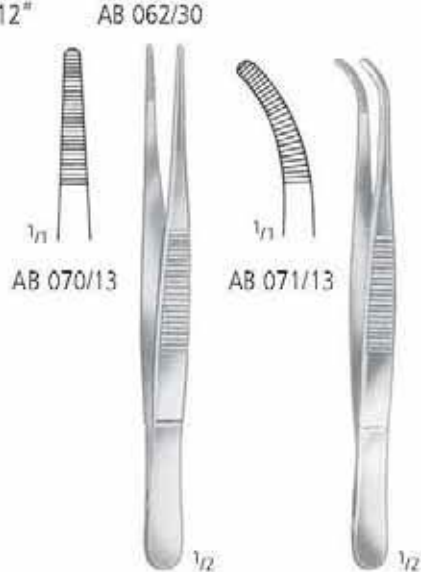

AB 070/13

AB 071/13

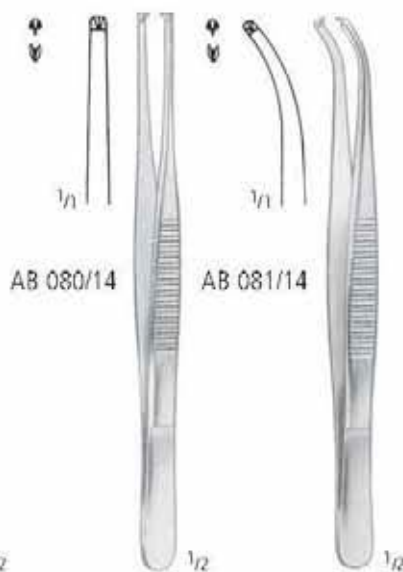

AB 080/14

AB 081/14

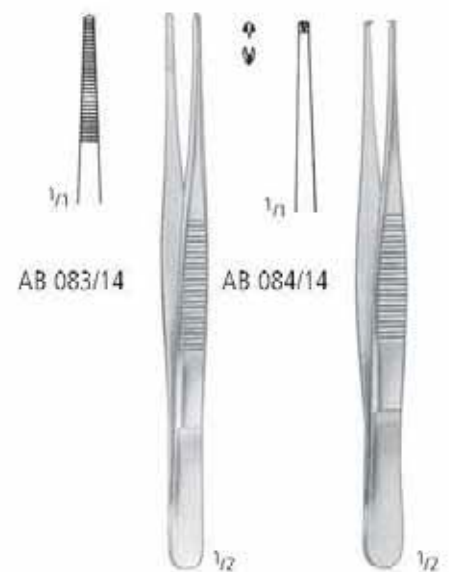

AB 083/14

AB 084/14

1:2

1:2

1:2

schmal - narrow - estrechas - étroites - strette

fein - delicate - finas - fines - fine

10,5 cm/4 <sup>1</sup> / <sub>4</sub> "	AB 070/10	AB 071/10	AB 080/10	AB 081/10
11,5 cm/4 <sup>1</sup> / <sub>2</sub> "	AB 070/11	AB 071/11	AB 080/11	AB 081/11
13,0 cm/5"	AB 070/13	AB 071/13	AB 080/13	AB 081/13
14,5 cm/5 <sup>3</sup> / <sub>4</sub> "	AB 070/14	AB 071/14	AB 080/14	AB 081/14
16,0 cm/6 <sup>1</sup> / <sub>4</sub> "	AB 070/16	AB 071/16	AB 080/16	AB 081/16
18,0 cm/7"	AB 070/18	AB 071/18	AB 080/18	AB 081/18
20,0 cm/8"	AB 070/20	AB 071/20	AB 080/20	AB 081/20
23,0 cm/9"	AB 070/23		AB 080/23	
25,0 cm/10"	AB 070/25	AB 071/25	AB 080/25	AB 081/25
30,0 cm/12"	AB 070/30	AB 071/30	AB 080/30	AB 081/30

AB 083/13	AB 084/13
AB 083/14	AB 084/14

PINZETTEN FORCEPS PINZAS PINCES PINZE

Anatomische Pinzetten, Chirurgische Pinzetten  
 Dressing forceps, Tissue Forceps  
 Pinzas de disección, Pinzas de disección con dientes  
 Pincès à dissection, Pincès à griffes  
 Pinze anatomiche per dissezione, Pinze chirurgiche a denti di topo

MODELL USA

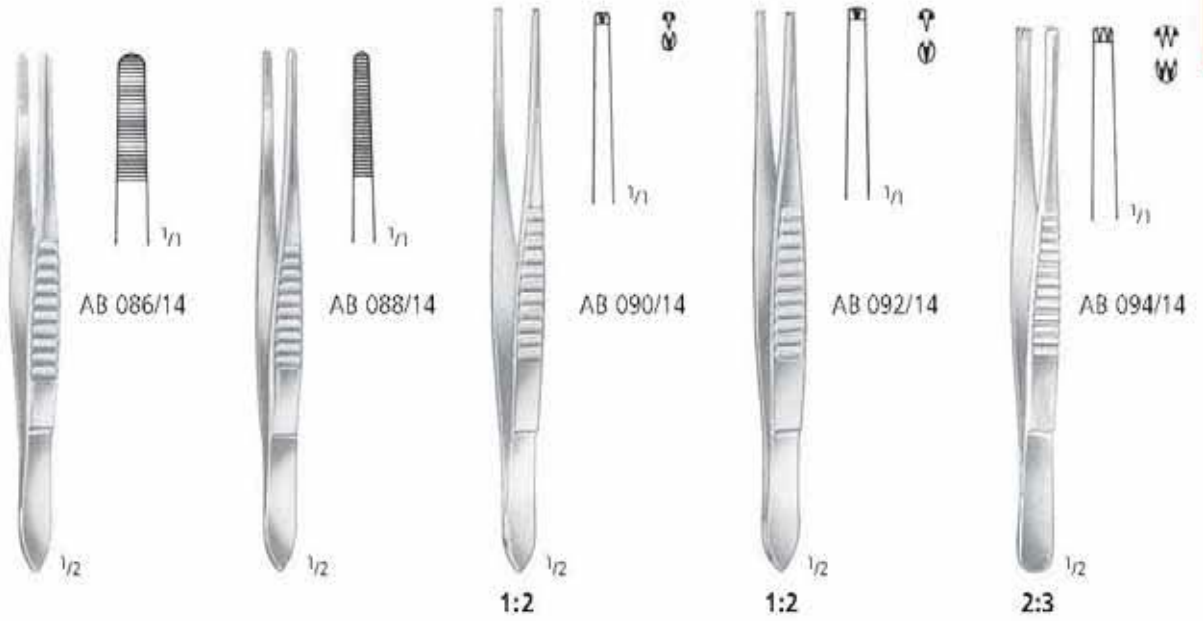

schmal - narrow - estrechas - étroites - strette

12,0 cm/4 <sup>3</sup> / <sub>4</sub> "	AB 086/12	AB 088/12		AB 092/12	AB 094/12
13,0 cm/5"	AB 086/13	AB 088/13	AB 090/13	AB 092/13	AB 094/13
14,5 cm/5 <sup>3</sup> / <sub>4</sub> "	AB 086/14	AB 088/14	AB 090/14	AB 092/14	AB 094/14
15,5 cm/6"	AB 086/15	AB 088/15	AB 090/15	AB 092/15	AB 094/15
18,0 cm/7"	AB 086/18			AB 092/18	AB 094/18
21,0 cm/8 <sup>1</sup> / <sub>4</sub> "	AB 086/21			AB 092/21	AB 094/21
25,0 cm/10"	AB 086/25			AB 092/25	AB 094/25
31,0 cm/12 <sup>1</sup> / <sub>4</sub> "	AB 086/31			AB 092/31	AB 094/31

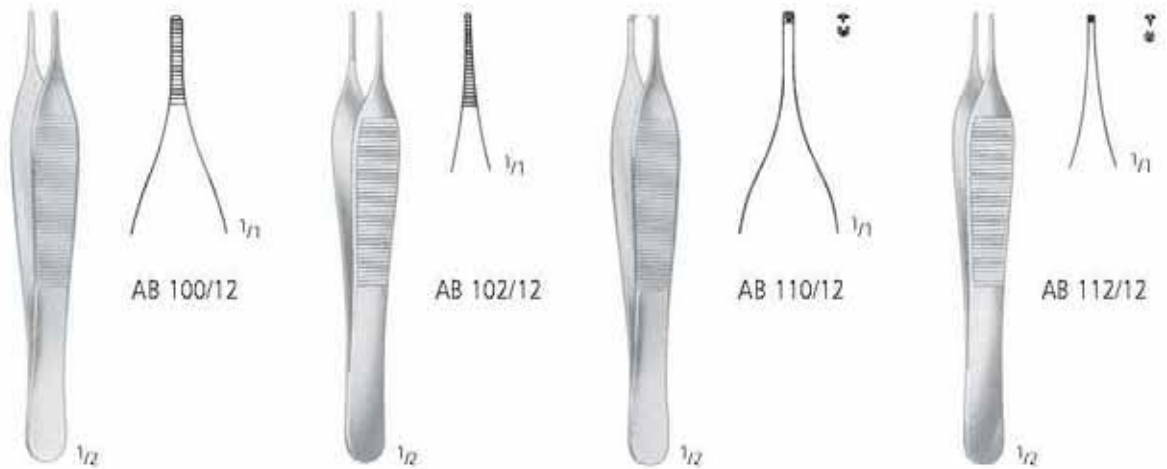

12,0 cm/4 <sup>3</sup> / <sub>4</sub> "	<b>ADSON</b> AB 100/12	<b>MICRO-ADSON</b> AB 102/12	<b>ADSON 1:2</b> AB 110/12	<b>MICRO-ADSON 1:2</b> AB 112/12
15,0 cm/6"	AB 100/15	AB 102/15	AB 110/15	AB 112/15

AA  
AB  
AC  
AD  
AE  
AF  
AK  
AL  
AM  
AO  
AP  
AR  
KA  
KD  
KU  
KY

**AB** PINZETTEN FORCEPS PINZAS PINCES PINZE

Anatomische Pinzetten, Chirurgische Pinzetten  
 Dressing Forceps, Tissue Forceps  
 Pinzas de disección, Pinzas de disección con dientes  
 Pincés à dissection, Pincés à griffes  
 Pinze anatomiche per dissezione, Pinze chirurgiche a denti di topo



**ADSON**  
 AB 114/12  
 12,0 cm/4<sup>3</sup>/<sub>4</sub>"



**ADSON 1:2**  
 AB 115/12  
 12,0 cm/4<sup>3</sup>/<sub>4</sub>"



**ADSON-BROWN**  
 12,0 cm/4<sup>3</sup>/<sub>4</sub>"



**ADSON-BROWN**  
 AB 117/09  
 12,0 cm/4<sup>3</sup>/<sub>4</sub>"

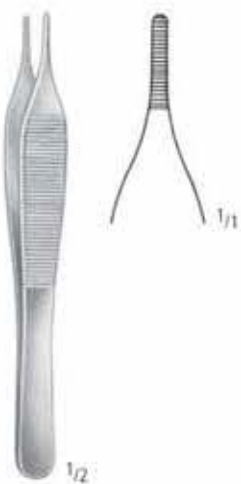

**EWALD**  
 AB 118/01  
 12,0 cm/4<sup>3</sup>/<sub>4</sub>"



**EWALD 1:2**  
 AB 118/02  
 12,0 cm/4<sup>3</sup>/<sub>4</sub>"



**McINDOE**  
 AB 119/15  
 15,0 cm/6"

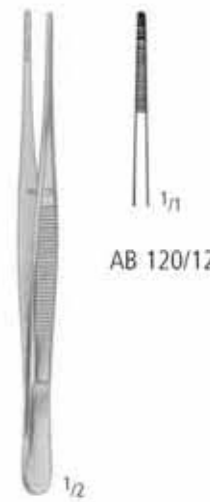

**SEMKEN**  
 AB 120/12  
 AB 120/15



**SEMKEN**  
 12,5 cm/5"  
 15,5 cm/6"  
 AB 121/12  
 AB 121/15



PINZETTEN FORCEPS PINZAS PINCES PINZE

Anatomische Pinzetten, Chirurgische Pinzetten  
 Dressing forceps, Tissue forceps  
 Pinzas de disección, Pinzas de disección con dientes  
 Pinces à dissection, Pinces à griffes  
 Pinze anatomiche per dissezione, Pinze chirurgiche a denti di topo

AA

AB

AC

AD

AE

AF

AK

AL

AM

AO

AP

AR

KA

KD

KU

KY

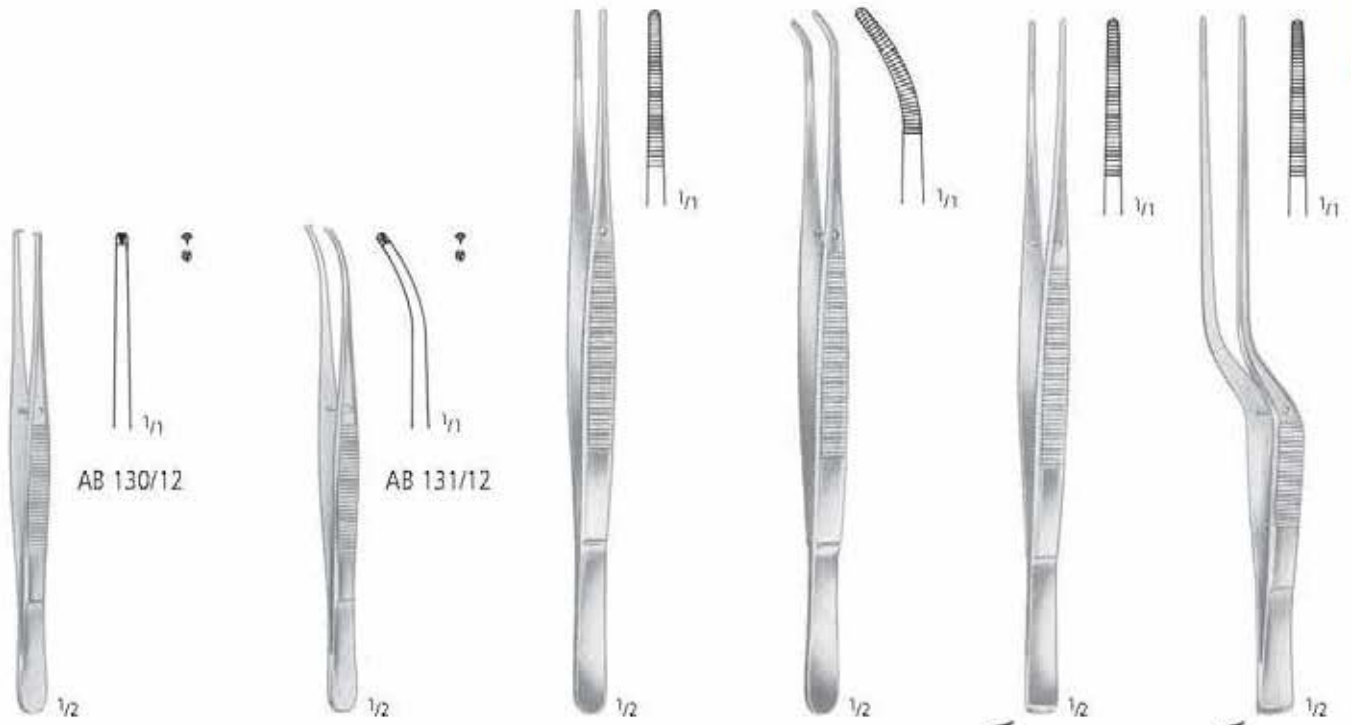

<b>SEMKEN 1:2</b>		<b>TAYLOR</b>	<b>TAYLOR</b>	<b>TAYLOR</b>	<b>TAYLOR</b>
AB 130/12	12,5 cm/5"	AB 140/17	AB 141/17	AB 142/17	AB 143/17
AB 130/15	15,5 cm/6"	AB 131/12	17,5 cm/7"	17,5 cm/7"	17,5 cm/7"
		AB 131/15			

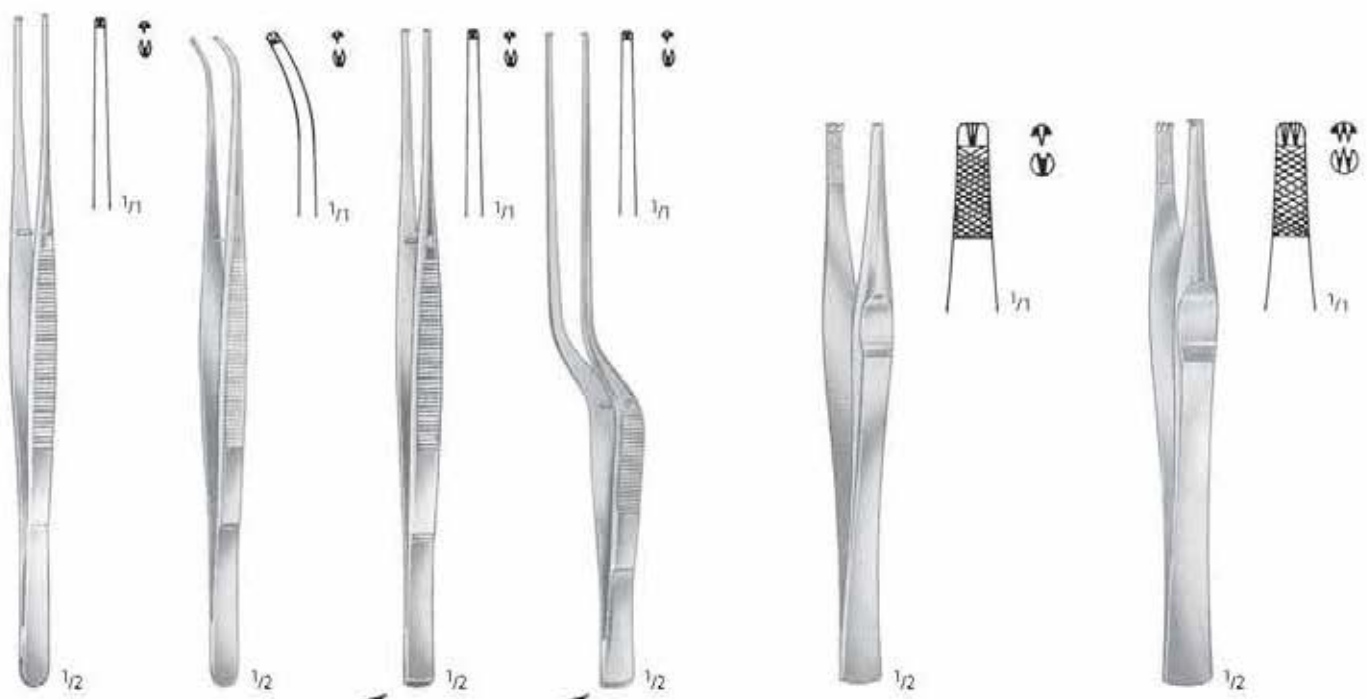

<b>TAYLOR</b>	<b>TAYLOR</b>	<b>TAYLOR</b>	<b>TAYLOR</b>	<b>LANE</b>	<b>LANE</b>
1:2	1:2	1:2	1:2	1:2	2:3
AB 150/17	AB 151/17	AB 152/17	AB 153/17	AB 156/14	AB 158/14
17,5 cm/7"	17,5 cm/7"	17,5 cm/7"	17,5 cm/7"	14,5 cm/5 <sup>3</sup> / <sub>4</sub> "	AB 158/20
				AB 156/20	20,0 cm/8"

**AB** PINZETTEN FORCEPS PINZAS PINCES PINZE

Anatomische Pinzetten, Chirurgische Pinzetten  
 Dressing Forceps, Tissue Forceps  
 Pinzas de disección, Pinzas de disección con dientes  
 Pincés à dissection, Pincés à griffes  
 Pinze anatomiche per dissezione, Pinze chirurgiche a denti di topo



**GERALD**  
 AB 160/18

18,0 cm/7"



**GERALD**  
 AB 161/18



**GERALD 1:2**  
 AB 170/18

18,0 cm/7"



**GERALD 1:2**  
 AB 171/18



**CUSHING**  
 AB 180/17

17,5 cm/7"



**CUSHING**  
 AB 181/17



**CUSHING 1:2**  
 AB 190/17

17,5 cm/7"



**CUSHING 1:2**  
 AB 191/17



PINZETTEN FORCEPS PINZAS PINCES PINZE

Anatomische Pinzetten, Chirurgische Pinzetten  
 Dressing Forceps, Tissue Forceps  
 Pinzas de disección, Pinzas de disección con dientes  
 Pincés à dissection, Pincés à griffes  
 Pinze anatomiche per dissezione, Pinze chirurgiche a denti di topo



AB 200/18

**POTTS-SMITH**

1/2



AB 201/18



AB 210/18

**POTTS-SMITH  
1:2**

1/2



AB 211/18

1/2

18,0 cm/7"  
 21,0 cm/8 1/4"  
 25,0 cm/10"

AB 200/18  
 AB 200/21  
 AB 200/25

AB 201/18  
 AB 201/21  
 AB 201/25

AB 210/18  
 AB 210/21  
 AB 210/25

AB 211/18  
 AB 211/21  
 AB 211/25



**BROPHY**

1/2



AB 251/20



**BROPHY  
1:2**

1/2



AB 261/20

20,0 cm/8"

AB 250/20

AB 260/20

**AB** PINZETTEN FORCEPS PINZAS PINCES PINZE

Anatomische Pinzetten, Chirurgische Pinzetten  
 Dressing Forceps, Tissue forceps  
 Pinzas de disección, Pinzas de disección con dientes  
 Pincers à dissection, Pincers à griffes  
 Pinze anatomiche per dissezione, Pinze chirurgiche a denti di topo

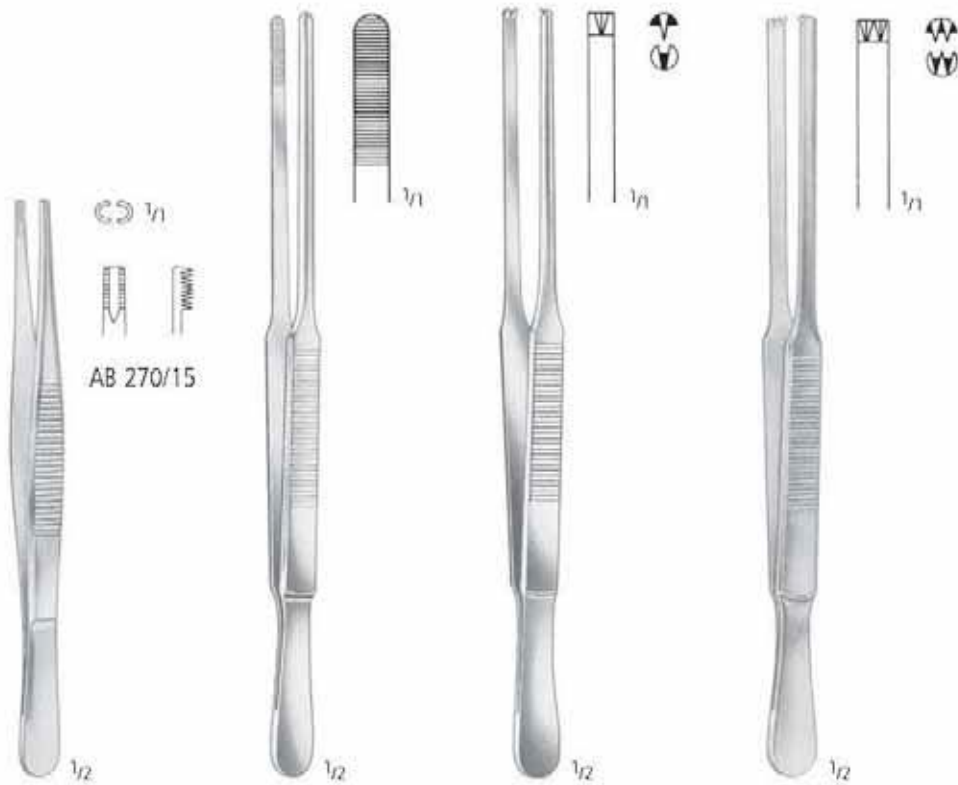

AB 270/15

**BROWN**  
 15,0 cm/6"  
 20,0 cm/8"  
 25,0 cm/10"  
 AB 270/15  
 AB 270/20  
 AB 270/25

**DUEHRSSSEN**  
 AB 290/20

**DUEHRSSSEN 1:2**  
 AB 292/20

**DUEHRSSSEN 2:3**  
 AB 294/20

PINZETTEN FORCEPS PINZAS PINCES PINZE

Anatomische Pinzetten, Chirurgische Pinzetten  
 Dressing Forceps, Tissue Forceps  
 Pinzas de disección, Pinzas de disección con dientes  
 Pincés à dissection, Pincés à griffes  
 Pinze anatomiche per dissezione, Pinze chirurgiche a denti di topo



**WANGENSTEIN**  
 AB 306/23  
 23,0 cm/9"



**STILLE-BARRAYA 3:4**  
 18,0 cm/7" AB 316/18  
 20,0 cm/8" AB 316/20  
 25,0 cm/10" AB 316/25



**FERRIS-SMITH 2:3**  
 AB 320/18  
 18,0 cm/7"



**STILLE**  
 AB 370/11  
 AB 370/13  
 AB 370/15



**STILLE 1:2**  
 AB 380/15  
 15,0 cm/6"



**STILLE 2:3**  
 AB 382/15  
 15,0 cm/6"

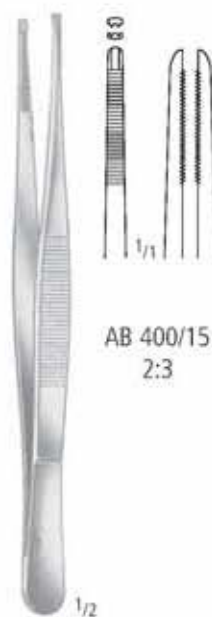

**ADLERKREUTZ**  
 15,0 cm/6" AB 400/15  
 20,0 cm/8" AB 400/20  
 25,0 cm/10"

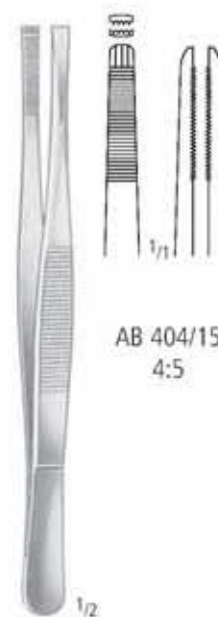

**STILLE 4:5**  
 AB 404/15  
 AB 404/20  
 AB 404/25

AA  
 AB  
 AC  
 AD  
 AE  
 AF  
 AG  
 AH  
 AI  
 AJ  
 AK  
 AL  
 AM  
 AN  
 AO  
 AP  
 AR  
 AS  
 AT  
 AU  
 AV  
 AW  
 AX  
 AY  
 AZ

**AB** PINZETTEN FORCEPS PINZAS PINCES PINZE

Fasspinzetten  
 Grasping forceps  
 Pinzas para coger  
 Pincas pour saisir les tissus  
 Pinze per afferrare tessuti

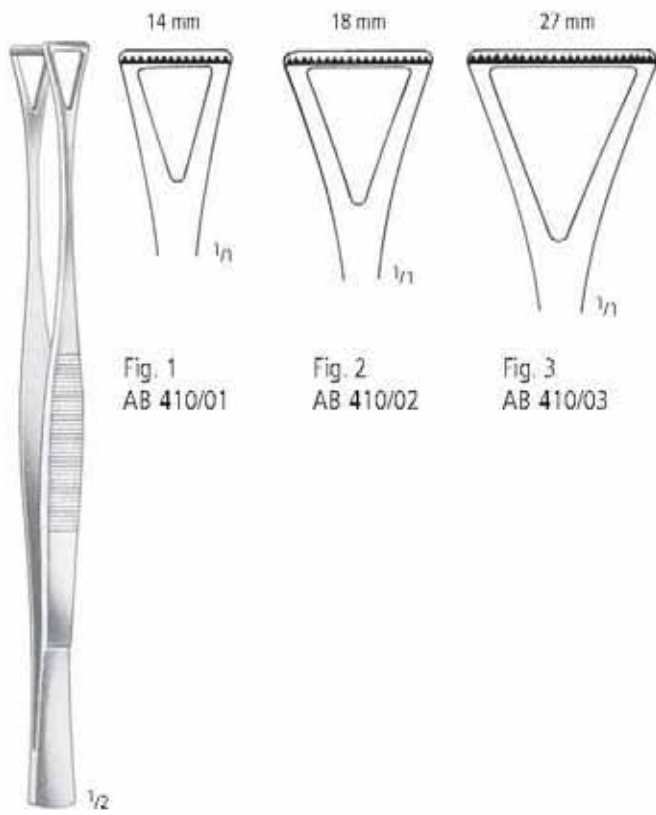
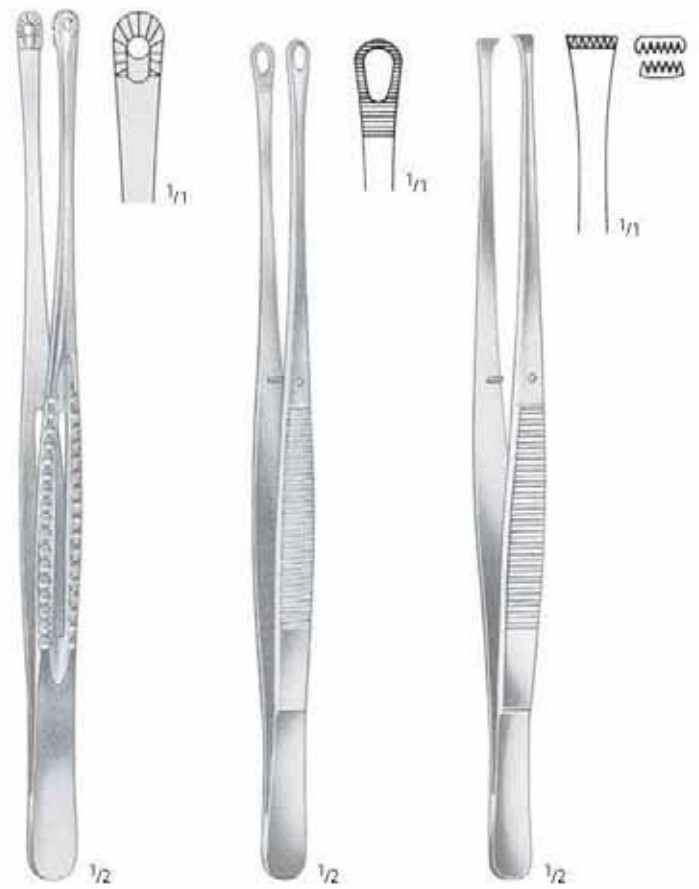

Fig. 1  
 AB 410/01

Fig. 2  
 AB 410/02

Fig. 3  
 AB 410/03

**COLLIN-DUVAL**  
 20,0 cm/8"



**MAYO-RUSS.**  
 AB 414/23  
 23,0 cm/9"

**SINGLEY-TUTTLE**  
 AB 416/23  
 23,0 cm/9"

**NELSON**  
 AB 418/23  
 23,0 cm/9"

PINZETTEN FORCEPS PINZAS PINCES PINZE

Chirurgische Pinzetten, Fasspinzetten  
 Tissue forceps, Grasping forceps  
 Pinzas de disección con dientes, Pinzas para coger  
 Pinces à griffes, Pincers pour saisir les tissus  
 Pinze chirurgiche a denti di topo, Pinze per afferrare tessuti



**GILLIES 1:2**  
 AB 430/15  
 15,0 cm/6"



**WAUGH 1:2**  
 AB 434/20  
 20,5 cm/8"



AB 440/10  
 10,5 cm/4 1/4"

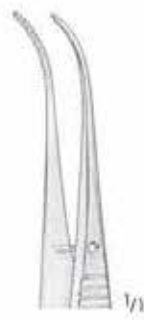

AB 441/10



AB 443/10



**1:2**  
 AB 444/10  
 10,5 cm/4 1/4"



AB 445/10

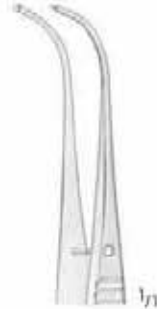

AB 447/10

AA

AB

AC

AD

AE

AF

AK

AL

AM

AO

AP

AR

KA

KD

KU

KY

**AB** PINZETTEN FORCEPS PINZAS PINCES PINZE

Chirurgische Pinzetten, Fasspinzetten  
 Tissue Forceps, Grasping forceps  
 Pinzas de disección con dientes, Pinzas para coger  
 Pincas à griffes, Pincas pour saisir les tissus  
 Pinze chirurgiche a denti di topo, Pinze per afferrare tessuti



AB 480/15



AB 484/16

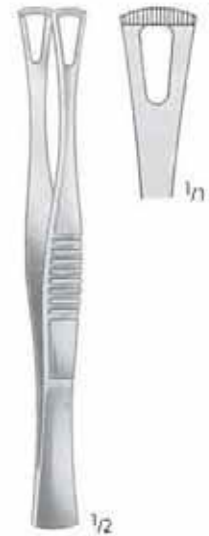

**DUVAL**  
 AB 486/14  
 14,5 cm/5<sup>3</sup>/<sub>4</sub>"

**RUSS. MODELL**  
 15,0 cm/6"  
 20,0 cm/8"  
 25,0 cm/10"  
 AB 480/15  
 AB 480/20  
 AB 480/25

**DURANTE**  
 14,5 cm/5<sup>3</sup>/<sub>4</sub>"  
 16,0 cm/6<sup>1</sup>/<sub>4</sub>"  
 20,0 cm/8"  
 AB 484/14  
 AB 484/16  
 AB 484/20



**BONNEY 1:2**  
 AB 490/18  
 18,0 cm/7"











**BONNEY 2:3**  
 AB 492/18  
 18,0 cm/7"



PINZETTEN FORCEPS PINZAS PINCES PINZE

Uhrmacherpinzetten  
 Jeweler's Forceps  
 Pinzas de relojero  
 Pincas d'horloger  
 Pinze da orologiaio

	1n	No. 1	AB 501/01 12,0 cm/4 <sup>3</sup> / <sub>4</sub> "	AA AB AC AD AE AF AK AL AM AO AP AR KA KD KY
	1n	No. 2	AB 501/02 12,0 cm/4 <sup>3</sup> / <sub>4</sub> "	
	1n	No. 3	AB 501/03 12,0 cm/4 <sup>3</sup> / <sub>4</sub> "	
	1n	No. 4	AB 501/04 11,0 cm/4 <sup>1</sup> / <sub>2</sub> "	
	1n	No. 5	AB 501/05 11,0 cm/4 <sup>1</sup> / <sub>2</sub> "	
	1n	No. 5a	AB 501/15 11,0 cm/4 <sup>1</sup> / <sub>2</sub> "	
	1n	No. 5/45°	AB 501/45 10,5 cm/4 <sup>1</sup> / <sub>4</sub> "	
	1n	No. 5/90°	AB 501/90 10,5 cm/4 <sup>1</sup> / <sub>4</sub> "	
	1n	No. 7	AB 502/07 11,5 cm/4 <sup>1</sup> / <sub>2</sub> "	

**AB** PINZETTEN FORCEPS PINZAS PINCES PINZE

Fasspinzetten  
Grasping Forceps  
Pinzas para coger  
Pincers pour saisir les tissus  
Pinze per afferrare tessuti



AB 506/01  
Ø 3,0 mm

AB 506/02  
Ø 3,0 mm

**SAMII**  
24,0 cm/9<sup>1</sup>/<sub>2</sub>"



AB 507/01  
Ø 3,0 mm

AB 507/02  
Ø 5,0 mm

Löffel  
Spoon

AB 508/01  
Ø 3,0 mm

AB 508/02  
Ø 5,0 mm

flach  
flat

22,0 cm/8<sup>3</sup>/<sub>4</sub>"



AB 509/01  
Ø 3,0 mm

AB 509/02  
Ø 5,0 mm

Kürette  
Curette

**HEIFETZ**  
22,0 cm/8<sup>3</sup>/<sub>4</sub>"



**HUNT**  
AB 510/20  
1/2 20,0 cm/8"



16,0 cm/6 <sup>1</sup> / <sub>4</sub> "	AB 515/16	AB 516/16	AB 517/16
18,0 cm/7"	AB 515/18	AB 516/18	AB 517/18
20,0 cm/8"	AB 515/20	AB 516/20	AB 517/20
22,0 cm/8 <sup>3</sup> / <sub>4</sub> "	AB 515/22	AB 516/22	
24,0 cm/9 <sup>1</sup> / <sub>2</sub> "	AB 515/24	AB 516/24	

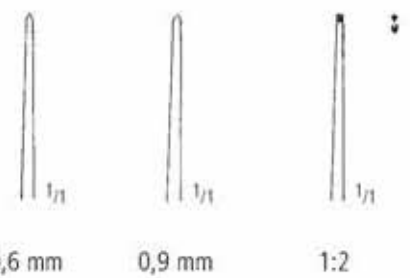

0,6 mm      0,9 mm      1:2

PINZETTEN FORCEPS PINZAS PINCES PINZE

Mikro-Pinzetten, Knüpfpinzetten mit Plateau  
 Micro Forceps, Suture Tying Forceps with platform  
 Micro-Pinzas, Pinzas de ligadura con plataforma  
 Micro-Pinces, Pinces à ligature avec plate-forme  
 Micro-Pinze, Pinze per ligature con piattaforma

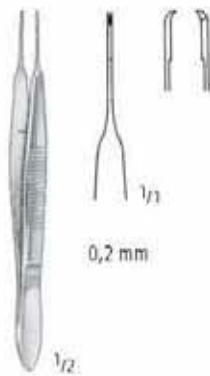

**1:2**  
 AB 530/09  
 9,5 cm/3<sup>3</sup>/<sub>4</sub>"



**AUSTIN**  
 AB 532/14  
 14,0 cm/5<sup>1</sup>/<sub>2</sub>"



**AUSTIN**  
 AB 532/18  
 18,0 cm/7"



AB 534/12  
 12,0 cm/4<sup>3</sup>/<sub>4</sub>"



**VISE**  
 AB 534/13  
 13,5 cm/5<sup>1</sup>/<sub>4</sub>"



**VISE**  
 AB 535/13  
 13,5 cm/5<sup>1</sup>/<sub>4</sub>"

AA  
**AB**  
 AC  
 AD  
 AE  
 AF  
 AG  
 AH  
 AI  
 AJ  
 AK  
 AL  
 AM  
 AN  
 AO  
 AP  
 AQ  
 AR  
 AS  
 AT  
 AU  
 AV  
 AW  
 AX  
 AY  
 AZ  
 BA  
 BB  
 BC  
 BD  
 BE  
 BF  
 BG  
 BH  
 BI  
 BJ  
 BK  
 BL  
 BM  
 BN  
 BO  
 BP  
 BQ  
 BR  
 BS  
 BT  
 BU  
 BV  
 BW  
 BX  
 BY  
 BZ  
 CA  
 CB  
 CC  
 CD  
 CE  
 CF  
 CG  
 CH  
 CI  
 CJ  
 CK  
 CL  
 CM  
 CN  
 CO  
 CP  
 CQ  
 CR  
 CS  
 CT  
 CU  
 CV  
 CW  
 CX  
 CY  
 CZ  
 DA  
 DB  
 DC  
 DD  
 DE  
 DF  
 DG  
 DH  
 DI  
 DJ  
 DK  
 DL  
 DM  
 DN  
 DO  
 DP  
 DQ  
 DR  
 DS  
 DT  
 DU  
 DV  
 DW  
 DX  
 DY  
 DZ  
 EA  
 EB  
 EC  
 ED  
 EE  
 EF  
 EG  
 EH  
 EI  
 EJ  
 EK  
 EL  
 EM  
 EN  
 EO  
 EP  
 EQ  
 ER  
 ES  
 ET  
 EU  
 EV  
 EW  
 EX  
 EY  
 EZ  
 FA  
 FB  
 FC  
 FD  
 FE  
 FF  
 FG  
 FH  
 FI  
 FJ  
 FK  
 FL  
 FM  
 FN  
 FO  
 FP  
 FQ  
 FR  
 FS  
 FT  
 FU  
 FV  
 FW  
 FX  
 FY  
 FZ  
 GA  
 GB  
 GC  
 GD  
 GE  
 GF  
 GG  
 GH  
 GI  
 GJ  
 GK  
 GL  
 GM  
 GN  
 GO  
 GP  
 GQ  
 GR  
 GS  
 GT  
 GU  
 GV  
 GW  
 GX  
 GY  
 GZ  
 HA  
 HB  
 HC  
 HD  
 HE  
 HF  
 HG  
 HH  
 HI  
 HJ  
 HK  
 HL  
 HM  
 HN  
 HO  
 HP  
 HQ  
 HR  
 HS  
 HT  
 HU  
 HV  
 HW  
 HX  
 HY  
 HZ  
 IA  
 IB  
 IC  
 ID  
 IE  
 IF  
 IG  
 IH  
 II  
 IJ  
 IK  
 IL  
 IM  
 IN  
 IO  
 IP  
 IQ  
 IR  
 IS  
 IT  
 IU  
 IV  
 IW  
 IX  
 IY  
 IZ  
 JA  
 JB  
 JC  
 JD  
 JE  
 JF  
 JG  
 JH  
 JI  
 JJ  
 JK  
 JL  
 JM  
 JN  
 JO  
 JP  
 JQ  
 JR  
 JS  
 JT  
 JU  
 JV  
 JW  
 JX  
 JY  
 JZ  
 KA  
 KB  
 KC  
 KD  
 KE  
 KF  
 KG  
 KH  
 KI  
 KJ  
 KK  
 KL  
 KM  
 KN  
 KO  
 KP  
 KQ  
 KR  
 KS  
 KT  
 KU  
 KV  
 KW  
 KX  
 KY  
 KZ  
 LA  
 LB  
 LC  
 LD  
 LE  
 LF  
 LG  
 LH  
 LI  
 LJ  
 LK  
 LL  
 LM  
 LN  
 LO  
 LP  
 LQ  
 LR  
 LS  
 LT  
 LU  
 LV  
 LW  
 LX  
 LY  
 LZ  
 MA  
 MB  
 MC  
 MD  
 ME  
 MF  
 MG  
 MH  
 MI  
 MJ  
 MK  
 ML  
 MM  
 MN  
 MO  
 MP  
 MQ  
 MR  
 MS  
 MT  
 MU  
 MV  
 MW  
 MX  
 MY  
 MZ  
 NA  
 NB  
 NC  
 ND  
 NE  
 NF  
 NG  
 NH  
 NI  
 NJ  
 NK  
 NL  
 NM  
 NN  
 NO  
 NP  
 NQ  
 NR  
 NS  
 NT  
 NU  
 NV  
 NW  
 NX  
 NY  
 NZ  
 OA  
 OB  
 OC  
 OD  
 OE  
 OF  
 OG  
 OH  
 OI  
 OJ  
 OK  
 OL  
 OM  
 ON  
 OO  
 OP  
 OQ  
 OR  
 OS  
 OT  
 OU  
 OV  
 OW  
 OX  
 OY  
 OZ  
 PA  
 PB  
 PC  
 PD  
 PE  
 PF  
 PG  
 PH  
 PI  
 PJ  
 PK  
 PL  
 PM  
 PN  
 PO  
 PP  
 PQ  
 PR  
 PS  
 PT  
 PU  
 PV  
 PW  
 PX  
 PY  
 PZ  
 QA  
 QB  
 QC  
 QD  
 QE  
 QF  
 QG  
 QH  
 QI  
 QJ  
 QK  
 QL  
 QM  
 QN  
 QO  
 QP  
 QQ  
 QR  
 QS  
 QT  
 QU  
 QV  
 QW  
 QX  
 QY  
 QZ  
 RA  
 RB  
 RC  
 RD  
 RE  
 RF  
 RG  
 RH  
 RI  
 RJ  
 RK  
 RL  
 RM  
 RN  
 RO  
 RP  
 RQ  
 RR  
 RS  
 RT  
 RU  
 RV  
 RW  
 RX  
 RY  
 RZ  
 SA  
 SB  
 SC  
 SD  
 SE  
 SF  
 SG  
 SH  
 SI  
 SJ  
 SK  
 SL  
 SM  
 SN  
 SO  
 SP  
 SQ  
 SR  
 SS  
 ST  
 SU  
 SV  
 SW  
 SX  
 SY  
 SZ  
 TA  
 TB  
 TC  
 TD  
 TE  
 TF  
 TG  
 TH  
 TI  
 TJ  
 TK  
 TL  
 TM  
 TN  
 TO  
 TP  
 TQ  
 TR  
 TS  
 TU  
 TV  
 TW  
 TX  
 TY  
 TZ  
 UA  
 UB  
 UC  
 UD  
 UE  
 UF  
 UG  
 UH  
 UI  
 UJ  
 UK  
 UL  
 UM  
 UN  
 UO  
 UP  
 UQ  
 UR  
 US  
 UT  
 UY  
 UZ  
 VA  
 VB  
 VC  
 VD  
 VE  
 VF  
 VG  
 VH  
 VI  
 VJ  
 VK  
 VL  
 VM  
 VN  
 VO  
 VP  
 VQ  
 VR  
 VS  
 VT  
 VU  
 VV  
 VW  
 VX  
 VY  
 VZ  
 WA  
 WB  
 WC  
 WD  
 WE  
 WF  
 WG  
 WH  
 WI  
 WJ  
 WK  
 WL  
 WM  
 WN  
 WO  
 WP  
 WQ  
 WR  
 WS  
 WT  
 WU  
 WV  
 WW  
 WX  
 WY  
 WZ  
 XA  
 XB  
 XC  
 XD  
 XE  
 XF  
 XG  
 XH  
 XI  
 XJ  
 XK  
 XL  
 XM  
 XN  
 XO  
 XP  
 XQ  
 XR  
 XS  
 XT  
 XU  
 XV  
 XW  
 XX  
 XY  
 XZ  
 YA  
 YB  
 YC  
 YD  
 YE  
 YF  
 YG  
 YH  
 YI  
 YJ  
 YK  
 YL  
 YM  
 YN  
 YO  
 YP  
 YQ  
 YR  
 YS  
 YT  
 YU  
 YV  
 YW  
 YX  
 YZ  
 ZA  
 ZB  
 ZC  
 ZD  
 ZE  
 ZF  
 ZG  
 ZH  
 ZI  
 ZJ  
 ZK  
 ZL  
 ZM  
 ZN  
 ZO  
 ZP  
 ZQ  
 ZR  
 ZS  
 ZT  
 ZU  
 ZV  
 ZW  
 ZX  
 ZY  
 ZZ

**AB** PINZETTEN FORCEPS PINZAS PINCES PINZE

Mikro-Pinzetten, Knüpfpinzetten mit Plateau, Gefäßdilator  
 Micro Forceps, Suture Tying Forceps with platform, Vessel Dilator  
 Micro-Pinzas, Pinzas de ligadura con plataforma, Dilatador para vasos  
 Micro-Pinces, Pinces à ligature avec plate-forme, Dilatateur pour vaisseaux  
 Micro-Pinze, Pinze per ligature con piattaforma, Dilatatore per vasi



AB 536/14  
 14,0 cm/5 1/2"



AB 538/14 1:2  
 14,0 cm/5 1/2"



AB 540/14 1:2  
 14,0 cm/5 1/2"

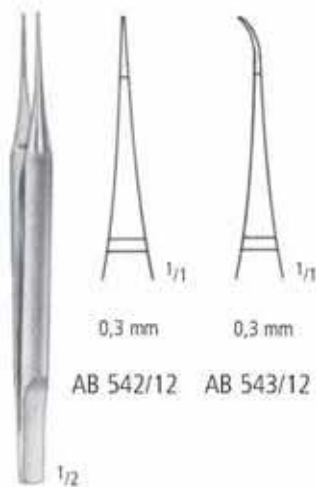

12,0 cm/4 3/4" AB 542/12 AB 543/12  
 15,0 cm/6" AB 542/15 AB 543/15

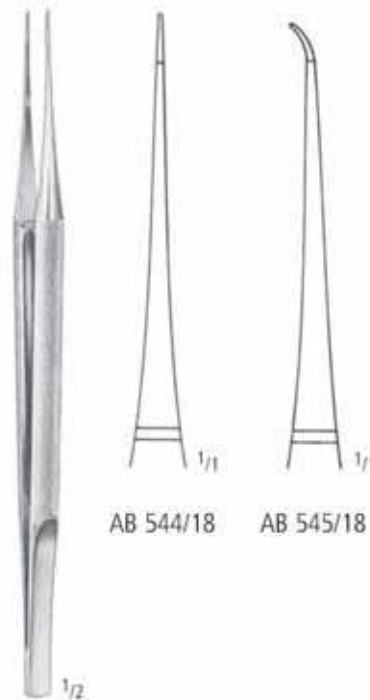

18,0 cm/7"



AB 546/11  
 11,0 cm/4 1/3"

PINZETTEN FORCEPS PINZAS PINCES PINZE

Splinter-Pinzetten  
 Splinter Forceps  
 Pinzas para espinas  
 Pincès à échardes  
 Pinze per schegge



AB 550/11

**FEILCHENFELD**

- 7,5 cm/3" AB 550/07
- 9,0 cm/3 1/2" AB 550/09
- 11,5 cm/4 1/2" AB 550/11

ohne Führungsstift  
 without guide pin  
 sin espiga de guía  
 sans repères  
 senza perno da guida

- 8,0 cm/3"
- 9,0 cm/3 1/2"
- 10,5 cm/4 1/4"
- 11,5 cm/4 1/2"
- 12,5 cm/5"
- 14,5 cm/5 3/4"



**HUNTER**  
 AB 552/10  
 10,5 cm/4 1/4"



**HUNTER**  
 AB 553/10  
 10,5 cm/4 1/4"



**WALTER-CARMALT**  
 AB 556/10  
 10,5 cm/4 1/4"



**WALTER-CARMALT**  
 AB 557/10  
 10,5 cm/4 1/4"



AB 560/10



AB 561/10



AB 562/10



AB 563/10



- AB 560/08
- AB 560/09
- AB 560/10
- AB 560/11
- AB 560/12
- AB 560/14

- AB 561/08
- AB 561/09
- AB 561/10
- AB 561/11
- AB 561/12
- AB 561/14

- AB 562/08
- AB 562/09
- AB 562/10
- AB 562/11
- AB 562/12
- AB 562/14

- AB 563/08
- AB 563/09
- AB 563/10
- AB 563/11
- AB 563/12
- AB 563/14

AA  
 AB  
 AC  
 AD  
 AE  
 AF  
 AK  
 AL  
 AM  
 AO  
 AP  
 AR  
 KA  
 KD  
 KU  
 KY

**AB** PINZETTEN FORCEPS PINZAS PINCES PINZE

Splitter-Pinzetten  
 Splinter Forceps  
 Pinzas para espinas  
 Pincas à échardes  
 Pinze per schegge

mit Führungsstift  
 with guide pin  
 con espiga de guía  
 avec repères  
 con pemo da guida



AB 564/10



AB 565/10



AB 566/10



AB 567/10



- 8,0 cm/3" AB 564/08
- 9,0 cm/3 1/2" AB 564/09
- 10,5 cm/4 1/4" AB 564/10
- 11,5 cm/4 1/2" AB 564/11
- 12,5 cm/5" AB 564/12
- 14,5 cm/5 3/4" AB 564/14

- AB 565/08
- AB 565/09
- AB 565/10
- AB 565/11
- AB 565/12
- AB 565/14

- AB 566/08
- AB 566/09
- AB 566/10
- AB 566/11
- AB 566/12
- AB 566/14

- AB 567/08
- AB 567/09
- AB 567/10
- AB 567/11
- AB 567/12
- AB 567/14



PINZETTEN FORCEPS PINZAS PINCES PINZE

Splitter-Pinzetten  
 Splinter Forceps  
 Pinzas para espinas  
 Pincas à échardes  
 Pinze per schegge

AA

AB

AC

AD

AE

AF

AK

AL

AM

AO

AP

AR

KA

KD

KU

KY

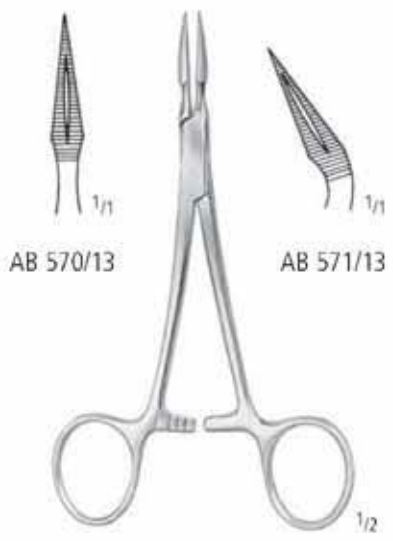

AB 570/13

AB 571/13

**STIEGLITZ**  
 13,5 cm/5 1/4"



**STIEGLITZ**  
 AB 571/90  
 13,5 cm/5 1/4"

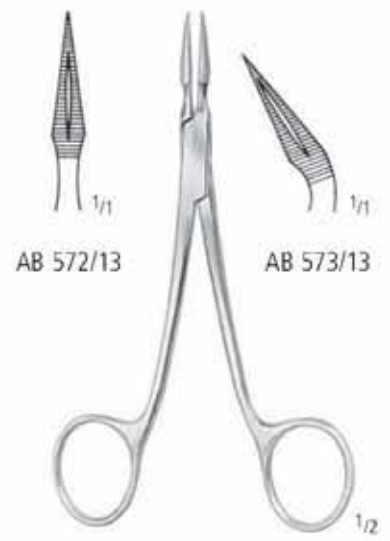

AB 572/13

AB 573/13

**STIEGLITZ**  
 13,5 cm/5 1/4"



**PEET**  
 AB 580/11  
 11,5 cm/4 1/2"

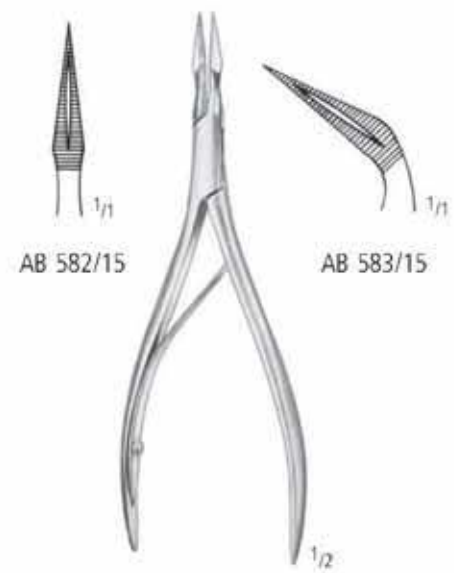

AB 582/15

AB 583/15

**RALK**  
 15,0 cm/6"

**AB** PINZETTEN FORCEPS PINZAS PINCES PINZE

Cilienpinzetten  
Cilia forceps  
Pinzas depilatorias  
Pincas à épiler les cils  
Pinze depilatorie



**LITTAUER**  
AB 620/08  
8,5 cm/3 1/3"



AB 621/09  
9,0 cm/3 1/2"



**DOUGLAS**  
AB 624/09  
9,0 cm/3 1/2"



**BEER**  
AB 626/09  
9,0 cm/3 1/2"



**ZIEGLER**  
AB 628/09  
9,0 cm/3 1/2"



**BARRAQUER**  
AB 633/10  
10,5 cm/4 1/4"



**GRADLE**  
AB 635/09  
9,5 cm/3 3/4"

PINZETTEN FORCEPS PINZAS PINCES PINZE

Ohr- und Nasenpinzetten  
 Ear and Nose Dressing Forceps  
 Pinzas auriculares y nasales  
 Pincas auriculaires et nasales  
 Pinze auricolare e nasale



**TROELTSCH (WILDE)**

AB 650/11  
 AB 650/12  
 AB 650/15  
 AB 650/18

11,0 cm/4<sup>1</sup>/<sub>3</sub>"  
 12,0 cm/4<sup>3</sup>/<sub>4</sub>"  
 15,0 cm/6"  
 18,0 cm/7"



**TROELTSCH (WILDE) 1:2**

AB 652/12  
 AB 652/15  
 AB 652/18



**TROELTSCH (WILDE)**

Mod. Jalasvirta

AB 654/11                      AB 654/13  
 11,0 cm/4<sup>1</sup>/<sub>3</sub>"                      13,0 cm/5"



**LUCAE**

AB 656/14  
 14,0 cm/5<sup>1</sup>/<sub>2</sub>"



**LUCAE 1:2**

AB 658/14  
 14,0 cm/5<sup>1</sup>/<sub>2</sub>"



**JANSEN**

16,0 cm/6<sup>1</sup>/<sub>4</sub>"                      AB 660/16  
 18,0 cm/7"                          AB 660/18  
 20,0 cm/8"                          AB 660/20



**COTTLE**

AB 665/14  
 14,0 cm/5<sup>1</sup>/<sub>2</sub>"

AA  
**AB**  
 AC  
 AD  
 AE  
 AF  
 AG  
 AH  
 AI  
 AJ  
 AK  
 AL  
 AM  
 AN  
 AO  
 AP  
 AQ  
 AR  
 AS  
 AT  
 AU  
 AV  
 AW  
 AX  
 AY  
 AZ

**AB** PINZETTEN FORCEPS PINZAS PINCES PINZE

Tampon-, Nasen- und Deckglaspinzetten  
 Dressing-, Tampon-, Nasal- and Cover Glass Forceps  
 Pinzas para compresas, tamponamientos, nasales y pinzas porta-laminillas  
 Pincés à pansements, nasales et pincés porte-lamelles  
 Pinze per tamponi e medicazione, nasali e pinze porta-lamelle



**GRUENWALD (JANSEN)**  
 AB 690/20  
 20,0 cm/8"



**GRUENWALD 1:2**  
 AB 692/20  
 20,0 cm/8"



**JACKSON**  
 22,0 cm/8<sup>3</sup>/<sub>4</sub>"



**KUEHNE**  
 AB 698/10  
 10,5 cm/4<sup>1</sup>/<sub>4</sub>"



**KUEHNE**  
 AB 699/10  
 10,5 cm/4<sup>1</sup>/<sub>4</sub>"

PINZETTEN FORCEPS PINZAS PINCES PINZE

Irispinzetten  
Iris Forceps  
Pinzas para iris  
Pincès à iris  
Pinze per inde



AB 700/07



AB 701/07



AB 702/07



AB 703/07

**GRAEFE**

7,0 cm/2<sup>3</sup>/<sub>4</sub>"

- 0,5 mm AB 700/05
- 0,7 mm AB 700/07
- 1,0 mm AB 700/10

**GRAEFE**

7,0 cm/2<sup>3</sup>/<sub>4</sub>"

- AB 701/05
- AB 701/07
- AB 701/10

**GRAEFE 1:2**

7,0 cm/2<sup>3</sup>/<sub>4</sub>"

- AB 702/05
- AB 702/07
- AB 702/10

**GRAEFE 1:2**

7,0 cm/2<sup>3</sup>/<sub>4</sub>"

- AB 703/05
- AB 703/07
- AB 703/10



**GRAEFE**



AB 710/07  
AB 710/10

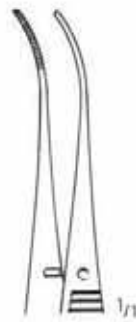

AB 711/07  
AB 711/10

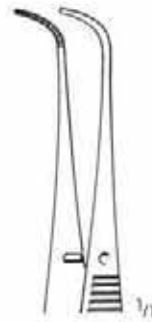

AB 713/07  
AB 713/10



AB 714/07  
AB 714/10



AB 715/07  
AB 715/10

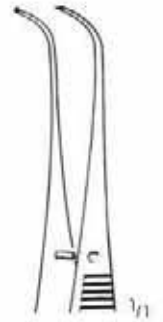

AB 717/07  
AB 717/10

7,0 cm/2<sup>3</sup>/<sub>4</sub>"  
10,0 cm/4"

AA  
AB  
AC  
AD  
AE  
AF  
AG  
AH  
AI  
AJ  
AK  
AL  
AM  
AN  
AO  
AP  
AQ  
AR  
AS  
AT  
AU  
AV  
AW  
AX  
AY  
AZ  
BA  
BB  
BC  
BD  
BE  
BF  
BG  
BH  
BI  
BJ  
BK  
BL  
BM  
BN  
BO  
BP  
BQ  
BR  
BS  
BT  
BU  
BV  
BW  
BX  
BY  
BZ  
CA  
CB  
CC  
CD  
CE  
CF  
CG  
CH  
CI  
CJ  
CK  
CL  
CM  
CN  
CO  
CP  
CQ  
CR  
CS  
CT  
CU  
CV  
CW  
CX  
CY  
CZ  
DA  
DB  
DC  
DD  
DE  
DF  
DG  
DH  
DI  
DJ  
DK  
DL  
DM  
DN  
DO  
DP  
DQ  
DR  
DS  
DT  
DU  
DV  
DW  
DX  
DY  
DZ  
EA  
EB  
EC  
ED  
EE  
EF  
EG  
EH  
EI  
EJ  
EK  
EL  
EM  
EN  
EO  
EP  
EQ  
ER  
ES  
ET  
EU  
EV  
EW  
EX  
EY  
EZ  
FA  
FB  
FC  
FD  
FE  
FF  
FG  
FH  
FI  
FJ  
FK  
FL  
FM  
FN  
FO  
FP  
FQ  
FR  
FS  
FT  
FU  
FV  
FW  
FX  
FY  
FZ  
GA  
GB  
GC  
GD  
GE  
GF  
GG  
GH  
GI  
GJ  
GK  
GL  
GM  
GN  
GO  
GP  
GQ  
GR  
GS  
GT  
GU  
GV  
GW  
GX  
GY  
GZ  
HA  
HB  
HC  
HD  
HE  
HF  
HG  
HH  
HI  
HJ  
HK  
HL  
HM  
HN  
HO  
HP  
HQ  
HR  
HS  
HT  
HU  
HV  
HW  
HX  
HY  
HZ  
IA  
IB  
IC  
ID  
IE  
IF  
IG  
IH  
II  
IJ  
IK  
IL  
IM  
IN  
IO  
IP  
IQ  
IR  
IS  
IT  
IU  
IV  
IW  
IX  
IY  
IZ  
JA  
JB  
JC  
JD  
JE  
JF  
JG  
JH  
JI  
JJ  
JK  
JL  
JM  
JN  
JO  
JP  
JQ  
JR  
JS  
JT  
JU  
JV  
JW  
JX  
JY  
JZ  
KA  
KB  
KC  
KD  
KE  
KF  
KG  
KH  
KI  
KJ  
KK  
KL  
KM  
KN  
KO  
KP  
KQ  
KR  
KS  
KT  
KU  
KV  
KW  
KX  
KY  
KZ  
LA  
LB  
LC  
LD  
LE  
LF  
LG  
LH  
LI  
LJ  
LK  
LL  
LM  
LN  
LO  
LP  
LQ  
LR  
LS  
LT  
LU  
LV  
LW  
LX  
LY  
LZ  
MA  
MB  
MC  
MD  
ME  
MF  
MG  
MH  
MI  
MJ  
MK  
ML  
MM  
MN  
MO  
MP  
MQ  
MR  
MS  
MT  
MU  
MV  
MW  
MX  
MY  
MZ  
NA  
NB  
NC  
ND  
NE  
NF  
NG  
NH  
NI  
NJ  
NK  
NL  
NM  
NN  
NO  
NP  
NQ  
NR  
NS  
NT  
NU  
NV  
NW  
NX  
NY  
NZ  
OA  
OB  
OC  
OD  
OE  
OF  
OG  
OH  
OI  
OJ  
OK  
OL  
OM  
ON  
OO  
OP  
OQ  
OR  
OS  
OT  
OU  
OV  
OW  
OX  
OY  
OZ  
PA  
PB  
PC  
PD  
PE  
PF  
PG  
PH  
PI  
PJ  
PK  
PL  
PM  
PN  
PO  
PP  
PQ  
PR  
PS  
PT  
PU  
PV  
PW  
PX  
PY  
PZ  
QA  
QB  
QC  
QD  
QE  
QF  
QG  
QH  
QI  
QJ  
QK  
QL  
QM  
QN  
QO  
QP  
QQ  
QR  
QS  
QT  
QU  
QV  
QW  
QX  
QY  
QZ  
RA  
RB  
RC  
RD  
RE  
RF  
RG  
RH  
RI  
RJ  
RK  
RL  
RM  
RN  
RO  
RP  
RQ  
RR  
RS  
RT  
RU  
RV  
RW  
RX  
RY  
RZ  
SA  
SB  
SC  
SD  
SE  
SF  
SG  
SH  
SI  
SJ  
SK  
SL  
SM  
SN  
SO  
SP  
SQ  
SR  
SS  
ST  
SU  
SV  
SW  
SX  
SY  
SZ  
TA  
TB  
TC  
TD  
TE  
TF  
TG  
TH  
TI  
TJ  
TK  
TL  
TM  
TN  
TO  
TP  
TQ  
TR  
TS  
TT  
TU  
TV  
TW  
TX  
TY  
TZ  
UA  
UB  
UC  
UD  
UE  
UF  
UG  
UH  
UI  
UJ  
UK  
UL  
UM  
UN  
UO  
UP  
UQ  
UR  
US  
UT  
UU  
UV  
UW  
UX  
UY  
UZ  
VA  
VB  
VC  
VD  
VE  
VF  
VG  
VH  
VI  
VJ  
VK  
VL  
VM  
VN  
VO  
VP  
VQ  
VR  
VS  
VT  
VU  
VV  
VW  
VX  
VY  
VZ  
WA  
WB  
WC  
WD  
WE  
WF  
WG  
WH  
WI  
WJ  
WK  
WL  
WM  
WN  
WO  
WP  
WQ  
WR  
WS  
WT  
WU  
WV  
WW  
WX  
WY  
WZ  
XA  
XB  
XC  
XD  
XE  
XF  
XG  
XH  
XI  
XJ  
XK  
XL  
XM  
XN  
XO  
XP  
XQ  
XR  
XS  
XT  
XU  
XV  
XW  
XX  
XY  
XZ  
YA  
YB  
YC  
YD  
YE  
YF  
YG  
YH  
YI  
YJ  
YK  
YL  
YM  
YN  
YO  
YP  
YQ  
YR  
YS  
YT  
YU  
YV  
YW  
YX  
YY  
YZ  
ZA  
ZB  
ZC  
ZD  
ZE  
ZF  
ZG  
ZH  
ZI  
ZJ  
ZK  
ZL  
ZM  
ZN  
ZO  
ZP  
ZQ  
ZR  
ZS  
ZT  
ZU  
ZV  
ZW  
ZX  
ZY  
ZZ

Irispinzetten  
Iris forceps  
Pinzas para iris  
Pincas à iris  
Pinze per iride



**STEVENS 1:2**  
AB 718/01  
11,0 cm/4<sup>1</sup>/<sub>3</sub>"



**STEVENS 1:2**  
AB 718/02  
11,0 cm/4<sup>1</sup>/<sub>3</sub>"



**STEVENS**  
10,5 cm/4<sup>1</sup>/<sub>4</sub>"



AB 720/01



AB 720/02



AB 720/03



AB 721/01 1:2



AB 721/02 1:2



AB 721/03 1:2



**FISCHER-ARLT 1:2**  
AB 723/07  
7,0 cm/2<sup>3</sup>/<sub>4</sub>"



PINZETTEN FORCEPS PINZAS PINCES PINZE

Irispinzetten  
Iris Forceps  
Pinzas para iris  
Pinces à iris  
Pinze per iride



**FOERSTER**  
AB 726/08  
8,5 cm/3 1/3"



**FOERSTER**  
AB 727/08  
8,5 cm/3 1/3"



**FOERSTER 1:2**  
AB 728/08  
8,5 cm/3 1/3"



**FOERSTER 1:2**  
AB 729/08  
8,5 cm/3 1/3"



**HESS 1:2**  
AB 730/07  
7,0 cm/2 3/4"



**HESS 1:2**  
AB 731/09  
9,0 cm/3 1/2"



**MOD. BONN 1:2**  
AB 734/01  
7,0 cm/2 3/4"



**MOD. BONN 1:2**  
AB 734/02  
7,0 cm/2 3/4"



**MOD. BONN**  
AB 735/01 AB 735/02  
7,0 cm/2 3/4"

AA  
AB  
AC  
AD  
AE  
AF  
AK  
AL  
AM  
AO  
AP  
AR  
KA  
KD  
KU  
KY

**AB** PINZETTEN FORCEPS PINZAS PINCES PINZE

Irispinzette  
Iris Forceps  
Pinzas para iris  
Pinces à iris  
Pinze per iride



**BISHOP-HARMAN 1:2**

AB 736/08  
8,5 cm/3 1/8"

AB 738/08  
8,5 cm/3 1/8"

**BISHOP-HARMAN 1:2**

AB 740/08  
8,5 cm/3 1/8"

AB 742/08  
8,5 cm/3 1/8"

**KIRBY 1:2**

AB 748/09  
9,0 cm/3 1/2"



AB 756/07

Zähne seitwärts  
teeth on side  
dientes laterales  
dents latérales  
denti laterali



AB 757/07

Zähne unten  
teeth below  
dientes inferiores  
dents en bas  
denti in basso

**BARRAQUER-KATZIN 1:2**  
**(Colibri)**

AB 750/07  
7,0 cm/2 3/4"

**TROUTMAN 1:2**  
**(Corneal)**

AB 751/07  
7,5 cm/3"

**BARRAQUER-KATZIN 1:2**  
**(Colibri)**

AB 752/07  
7,0 cm/2 3/4"

**GILL-HESS 1:2**

7,5 cm/3"

PINZETTEN FORCEPS PINZAS PINCES PINZE

Kapselpinzetten  
Capsular Forceps  
Pinzas capsulares  
Pincas capsulaires  
Pinze capsulari



**GILL 1:2**  
AB 762/07  
7,5 cm/3"



**GILL-FUCHS**  
AB 763/07  
7,5 cm/3"



**TERSON**  
AB 765/09  
9,0 cm/3 1/2"



**CASTROVIEJO**  
AB 767/01  
10,0 cm/4"



**CASTROVIEJO**  
AB 767/02  
10,0 cm/4"



ungeeicht  
not calibrated  
non calibrada  
non calibrée  
non calibrata

AB 768/01



geeicht  
calibrated  
calibrada  
calibrée  
calibrata

AB 768/02

**ARRUGA**  
10,0 cm/4"



ungeeicht  
not calibrated  
non calibrada  
non calibrée  
non calibrata

AB 769/01

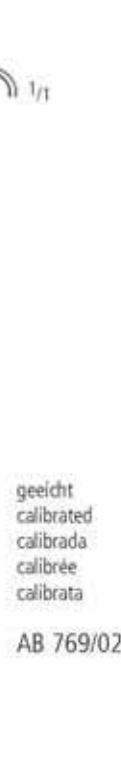

geeicht  
calibrated  
calibrada  
calibrée  
calibrata

AB 769/02

**ARRUGA**  
10,0 cm/4"



**BINKHORST**  
AB 770/07  
7,0 cm/2 3/4"

AA  
AB  
AC  
AD  
AE  
AF  
AK  
AL  
AM  
AO  
AP  
AR  
KA  
KD  
KU  
KY

**AB** PINZETTEN FORCEPS PINZAS PINCES PINZE

Fixierpinzetten  
Fixation Forceps  
Pinzas de fijación  
Pincas à fixer  
Pinze fissatrici

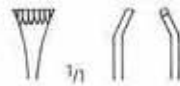

**AB 785/01**  
ohne Schloss  
without spring catch  
sin cierre de resorte  
sans arrêt à ressort  
senza arresto a molla

**AB 785/02**  
mit Schloss  
with spring catch  
con cierre de resorte  
avec arrêt à ressort  
con arresto a molla

**GRAEFE**  
11,0 cm/4 1/3"



**AB 786/01**  
5 mm

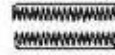

**AB 786/02**  
10 mm

**GREEN**  
10,0 cm/4"

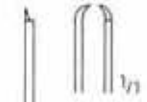

**AB 790/09**



**AB 791/09**

**CASTROVIEJO 1:1**  
9,0 cm/3 1/2"



**ELSCHNIG 1:2**  
AB 792/11  
11,0 cm/4 1/3"



**ELSCHNIG 2:3**  
AB 793/11  
11,0 cm/4 1/3"



**ELSCHNIG 3:4**  
AB 794/11  
11,0 cm/4 1/3"



**1:2**  
AB 796/02



**2:3**  
AB 796/03

**LESTER**  
9,0 cm/3 1/2"



**MOORFIELD**  
AB 798/10  
10,0 cm/4"



PINZETTEN FORCEPS PINZAS PINCES PINZE

Nahtpinzetten  
Suture Forceps  
Pinzas para sutura  
Pincas pour sutures  
Pinze per sutura

Vorderkammer-Pinzetten  
Anterior Chamber Forceps  
Pinzas para la cámara anterior  
Pincas pour la chambre antérieure  
Pinze per la camera anteriore

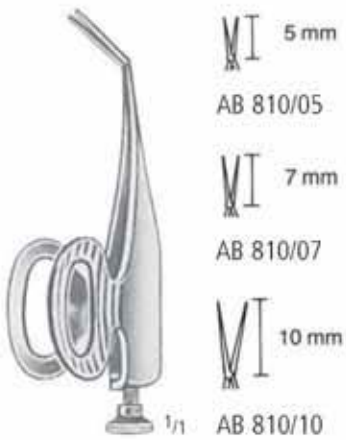

**BARRAQUER**  
5,5 cm/2<sup>1</sup>/<sub>4</sub>"



**ST. MARTIN 1:2**  
AB 812/07  
7,0 cm/2<sup>3</sup>/<sub>4</sub>"



**CASTROVIEJO 1:2**  
10,0 cm/4"



**CASTROVIEJO 1:2**  
10,0 cm/4"

- 0,12 mm AB 816/01
- 0,30 mm AB 816/03
- 0,50 mm AB 816/05
- 1,00 mm AB 816/10
- 1,50 mm AB 816/15



**McPHERSON**  
10,0 cm/4"



**KELMAN-McPHERSON 1:2**  
AB 820/10  
10,0 cm/4"



**BONACCOLTO**  
AB 824/01  
10,0 cm/4"



**BONACCOLTO**  
AB 824/02  
10,0 cm/4"

AA  
AB  
AC  
AD  
AE  
AF  
AK  
AL  
AM  
AO  
AP  
AR  
KA  
KD  
KY

**AB** PINZETTEN FORCEPS PINZAS PINCES PINZE

Nahtpinzetten  
Suture Forceps  
Pinzas para sutura  
Pinces pour sutures  
Pinze per sutura



10 x  
0,12 mm AB 825/01



**MOD. BONN**  
10,0 cm/4"



AB 825/02



**MOD. TÜBINGEN**  
AB 826/10  
10,0 cm/4"

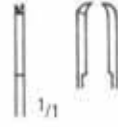

**PAUFIQUE 1:2**  
AB 828/10  
10,0 cm/4"

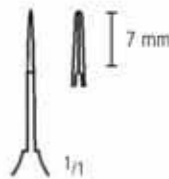

**HARMS**  
AB 829/01  
10,0 cm/4"

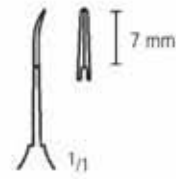

**HARMS**  
AB 829/02  
10,0 cm/4"



PINZETTEN FORCEPS PINZAS PINCES PINZE

Muskelpinzetten  
Muscular Forceps  
Pinzas musculares  
Pincas musculaires  
Pinze muscolare

AA

AB

AC

AD

AE

AF

AK

AL

AM

AO

AP

AR

KA

KD

KU

KY



**SATTLER**  
AB 830/01  
10,0 cm/4"



**SATTLER**  
AB 830/02  
10,0 cm/4"



**BLASCOVICS**  
AB 832/01  
9,0 cm/3 1/2"



**BLASCOVICS**  
AB 832/02  
9,0 cm/3 1/2"



**JAMESON**  
AB 833/01  
10,0 cm/4"



**JAMESON**  
AB 833/02  
10,0 cm/4"



**PRINCE**  
AB 834/01  
10,0 cm/4"



**PRINCE**  
AB 834/02  
10,0 cm/4"

**AB** PINZETTEN FORCEPS PINZAS PINCES PINZE

Muskel-, Entropium- und Chalazionpinzetten  
 Muscular, Entropium and Chalazion forceps  
 Pinzas musculares, Pinzas de entropion y de chalazión  
 Pincès musculaires, Pincès à entropion et à chalazion  
 Pinze muscolare, Pinze per palpebre (entropio) e per calazio



**BERENS**  
 AB 835/09  
 8,5 cm/3 1/3"



**ERHARDT**  
 AB 836/09  
 9,0 cm/3 1/2"



**SNELLEN**  
 AB 837/01  
 10,0 cm/4"



**SNELLEN**  
 AB 837/02  
 10,0 cm/4"



**AYER**  
 AB 838/01  
 9,0 cm/3 1/2"



**AYER**  
 AB 838/02  
 9,0 cm/3 1/2"



**DESMARRES**  
 9,0 cm/3 1/2"



AB 840/01



AB 840/02



AB 840/03

PINZETTEN FORCEPS PINZAS PINCES PINZE

Chalazionpinzetten  
Chalazion forceps  
Pinzas de chalazión  
Pincès à chalazion  
Pinze per calazio



**LAMPERT**  
AB 841/01  
9,0 cm/3 1/2"



**LAMPERT**  
AB 841/02  
9,0 cm/3 1/2"



**BERKE**  
AB 844/20  
11,0 cm/4 1/3"  
20 mm



**BERKE**  
AB 844/27  
11,0 cm/4 1/3"  
27 mm

AA  
AB  
AC  
AD  
AE  
AF  
AK  
AL  
AM  
AO  
AP  
AR  
KA  
KD  
KY

Linsenhalte- und Kapsulorhexispinzetten  
 Lens Holding and Capsulorhexis forceps  
 Pinzas para tener cristalino y capsulorhexis  
 Pincers à tenir de cristallins et capsulorhexis  
 Pinze per tenere il cristallino, Pinze capsulorhexis



**FAULKNER**  
 AB 848/11  
 11,0 cm/4<sup>1</sup>/<sub>3</sub>"



**McDONALD**  
 AB 852/01  
 10,0 cm/4"



**McDONALD**  
 AB 852/02  
 10,0 cm/4"

PINZETTEN FORCEPS PINZAS PINCES PINZE

Atraumatische Pinzetten  
 Non-traumatic Vascular Tissue Forceps  
 Pinzas Atrauma  
 Pincas Atrauma  
 Pinze Atrauma

AA

AB

AC

AD

AE

AF

AK

AL

AM

AO

AP

AR

KA

KD

KU

KY

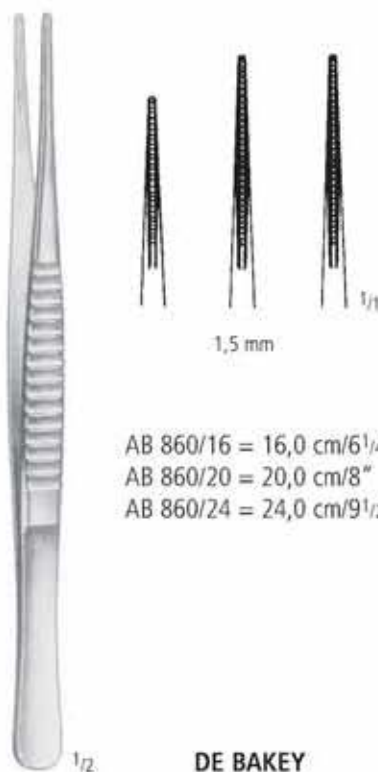

AB 860/16 = 16,0 cm/6<sup>1</sup>/<sub>4</sub>"  
 AB 860/20 = 20,0 cm/8"  
 AB 860/24 = 24,0 cm/9<sup>1</sup>/<sub>2</sub>"

DE BAKAY

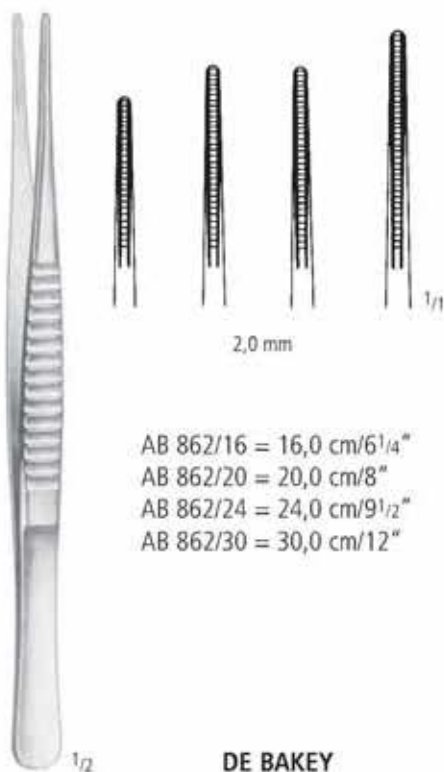

AB 862/16 = 16,0 cm/6<sup>1</sup>/<sub>4</sub>"  
 AB 862/20 = 20,0 cm/8"  
 AB 862/24 = 24,0 cm/9<sup>1</sup>/<sub>2</sub>"  
 AB 862/30 = 30,0 cm/12"

DE BAKAY

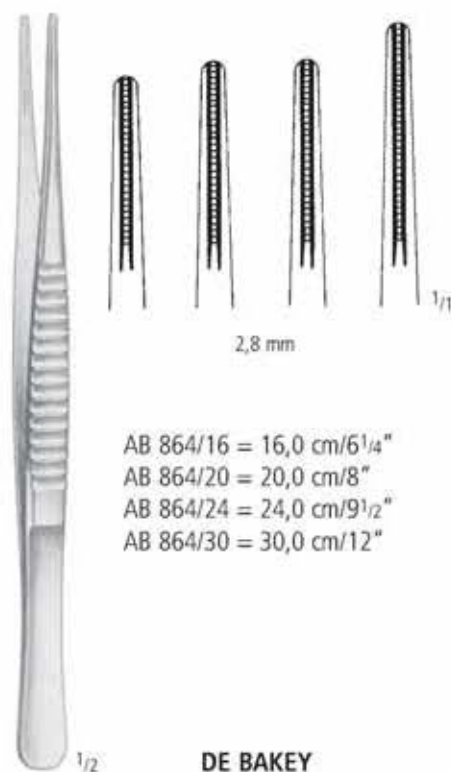

AB 864/16 = 16,0 cm/6<sup>1</sup>/<sub>4</sub>"  
 AB 864/20 = 20,0 cm/8"  
 AB 864/24 = 24,0 cm/9<sup>1</sup>/<sub>2</sub>"  
 AB 864/30 = 30,0 cm/12"

DE BAKAY

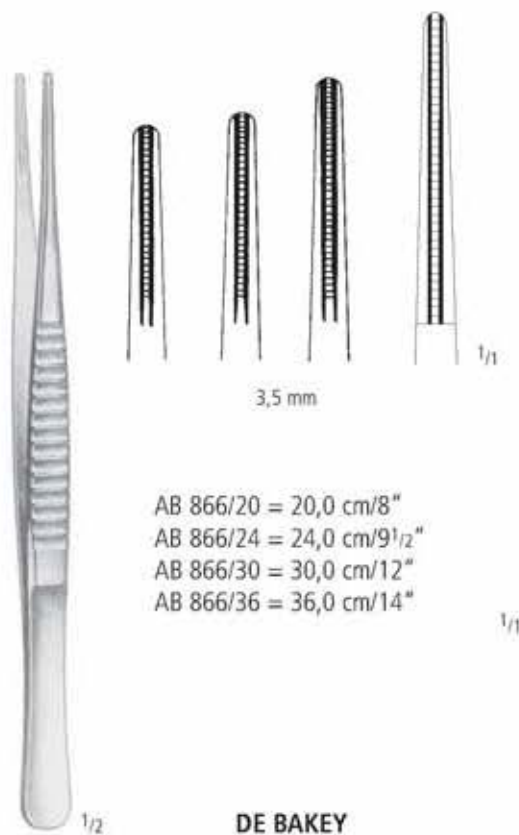

AB 866/20 = 20,0 cm/8"  
 AB 866/24 = 24,0 cm/9<sup>1</sup>/<sub>2</sub>"  
 AB 866/30 = 30,0 cm/12"  
 AB 866/36 = 36,0 cm/14"

DE BAKAY

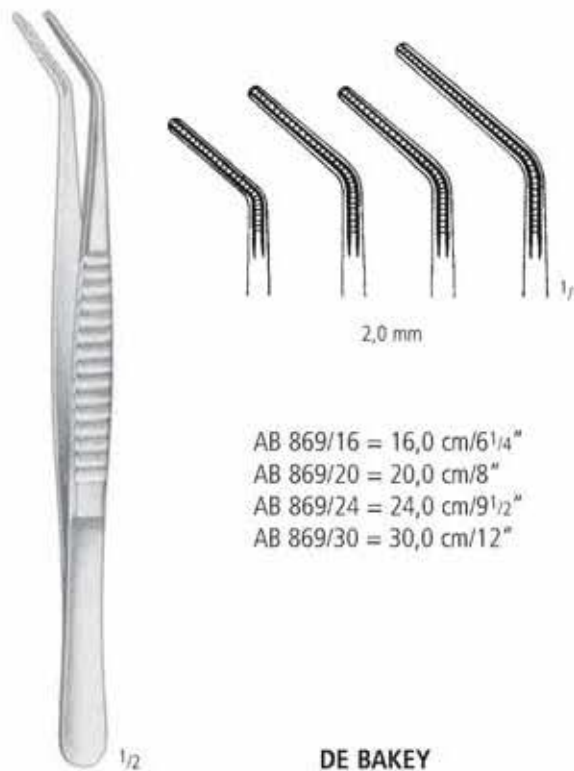

AB 869/16 = 16,0 cm/6<sup>1</sup>/<sub>4</sub>"  
 AB 869/20 = 20,0 cm/8"  
 AB 869/24 = 24,0 cm/9<sup>1</sup>/<sub>2</sub>"  
 AB 869/30 = 30,0 cm/12"

DE BAKAY

**AB** PINZETTEN FORCEPS PINZAS PINCES PINZE

Pinzetten mit Hartmetalleinsätzen  
 Dissecting Forceps with Tungsten Carbide Inserts  
 Pinzas de disección con bocas de carburo de tungsteno  
 Pincès à dissection avec mors en carbure de tungstène  
 Pinze per dissezione con punte di carburo di tungsteno

 <p>1/2</p> <p><b>POTTS-SMITH</b></p>	 <p>1/1</p> <p>AB 880/15 15,0 cm/6"</p>	 <p>1/1</p> <p>AB 880/18 18,0 cm/7"</p>	 <p>1/1</p> <p>AB 880/20 20,0 cm/8"</p>	 <p>1/2</p> <p><b>OEHLER 1:2</b></p>	 <p>1/1</p> <p>AB 882/14 14,0 cm/5 1/2"</p>	 <p>1/1</p> <p>AB 882/16 16,0 cm/6 1/4"</p>	 <p>1/1</p> <p>AB 882/18 18,0 cm/7"</p>
	 <p>1/1</p> <p>AB 880/23 23,0 cm/9"</p>	 <p>1/1</p> <p>AB 880/25 25,0 cm/10"</p>			 <p>1/1</p> <p>AB 882/20 20,0 cm/8"</p>	 <p>1/1</p> <p>AB 882/25 25,0 cm/10"</p>	 <p>1/1</p> <p>AB 882/30 30,0 cm/12"</p>



 <p>1/2</p> <p><b>SEMKEN</b></p> <p>AB 890/12 12,5 cm/5"          AB 890/15 15,5 cm/6"</p>	 <p>1/1</p> <p>AB 890/12</p>	 <p>1/2</p> <p><b>GILLIES 1:2</b></p> <p>AB 900/15 15,0 cm/6"</p>	 <p>1/1</p>	 <p>1/2</p> <p><b>JEWELER</b></p> <p>AB 902/15 15,0 cm/6"</p>	 <p>1/1</p>
---	---	--	--	--	--



PINZETTEN FORCEPS PINZAS PINCES PINZE

Pinzetten mit Hartmetalleinsätzen  
 Dissecting forceps with Tungsten Carbide Inserts  
 Pinzas de disección con bocas de carburo de tungsteno  
 Pincers à dissection avec mors en carbure de tungstène  
 Pinze per dissezione con punte di carburo di tungsteno

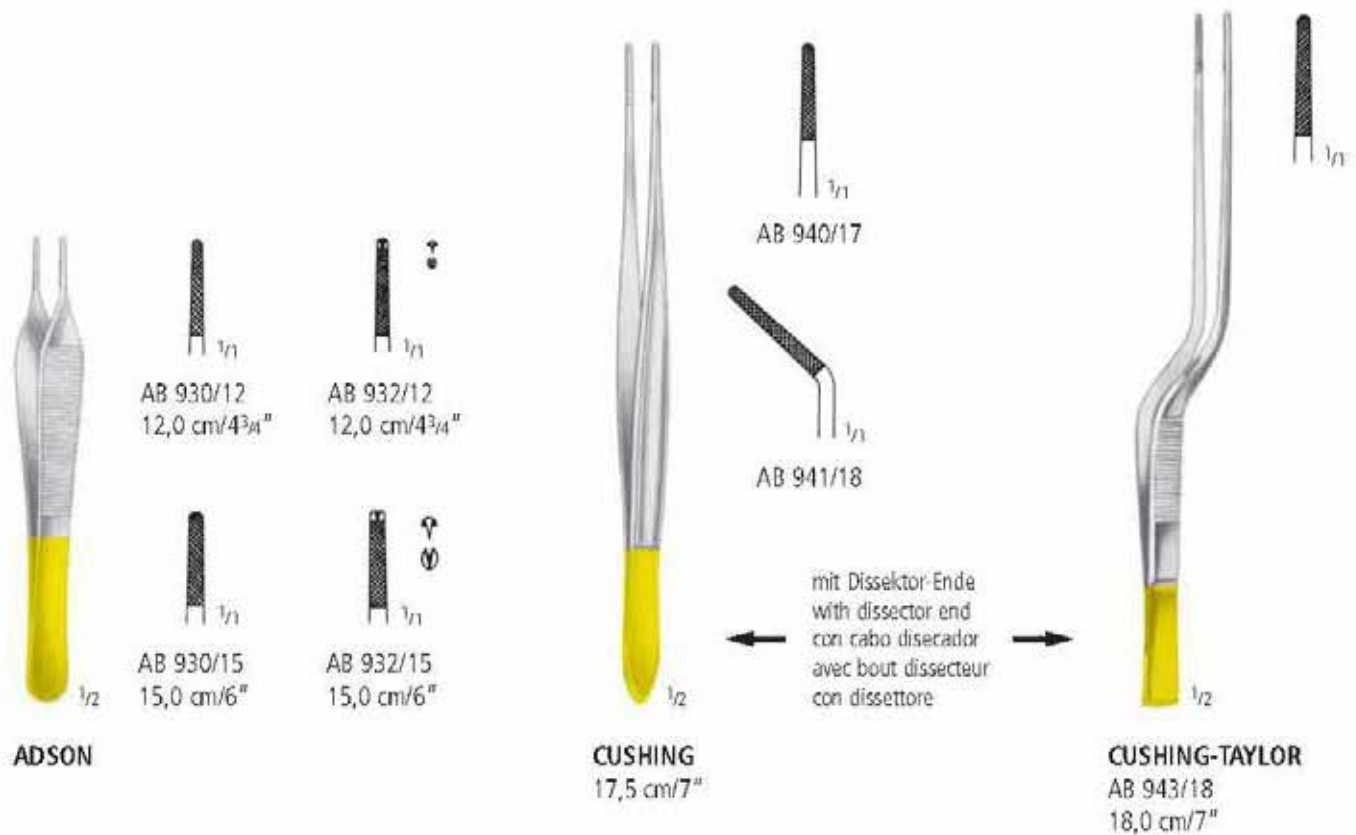

AA  
 AB  
 AC  
 AD  
 AE  
 AF  
 AG  
 AH  
 AI  
 AJ  
 AK  
 AL  
 AM  
 AN  
 AO  
 AP  
 AQ  
 AR  
 AS  
 AT  
 AU  
 AV  
 AW  
 AX  
 AY  
 AZ

**AB** PINZETTEN FORCEPS PINZAS PINCES PINZE

Pinzetten mit Hartmetalleinsätzen  
 Dissecting Forceps with Tungsten Carbide Inserts  
 Pinzas de disección con bocas de carburo de tungsteno  
 Pincès à dissection avec mors en carbure de tungstène  
 Pinze per dissezione con punte di carburo di tungsteno



**DE BAKHEY**  
 16,0 cm/6<sup>1</sup>/<sub>4</sub>"  
 20,0 cm/8"  
 24,0 cm/9<sup>1</sup>/<sub>2</sub>"

1,5 mm	2,0 mm
AB 944/16	AB 946/16
AB 944/20	AB 946/20
AB 944/24	AB 946/24



**BONNEY 1:2**  
 AB 948/18  
 18,0 cm/7"



**WANGENSTEEN**

PINZETTEN FORCEPS PINZAS PINCES PINZE

Zahnpinzetten  
 Cotton and Dressing Pliers  
 Pinzas para algodón y curaciones  
 Précelles (Brucelles) pour coton  
 Pinze per cotone



Fig. 1

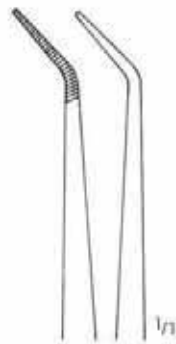

Fig. 3



Fig. 5

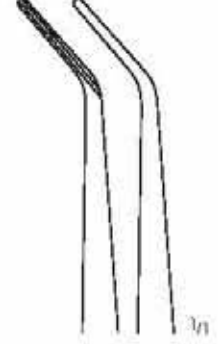

Fig. 8



**LONDON COLLEGE**  
 15,0 cm/6"  
 AB 970/01  
 AB 970/03  
 AB 970/05

Fig. 1  
 Fig. 3  
 Fig. 5  
 Fig. 8



**LONDON COLLEGE**  
 15,0 cm/6"  
 AB 971/01  
 AB 971/03  
 AB 971/05



**LONDON COLLEGE**  
 15,0 cm/6"  
 AB 973/01  
 AB 973/03  
 AB 973/05  
 AB 973/08

AA

AB

AC

AD

AE

AF

AK

AL

AM

AO

AP

AR

KA

KD

KU

KY

Zahnpinzetten  
 Cotton and Dressing Pliers  
 Pinzas para algodón y curaciones  
 Précelles (Brucelles) pour coton  
 Pinze per cotone



Fig. 1



Fig. 3

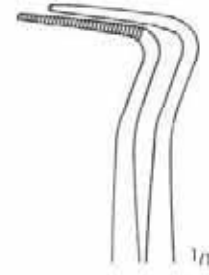

Fig. 5



**MERIAM**  
 16,0 cm/6 1/4"  
 AB 976/01  
 AB 976/03  
 AB 976/05



**MERIAM**  
 16,0 cm/6 1/4"  
 AB 977/01  
 AB 977/03  
 AB 977/05



**FLAGG**  
 16,0 cm/6 1/4"  
 AB 978/01  
 AB 978/03



**FLAGG**  
 16,0 cm/6 1/4"  
 AB 979/01  
 AB 979/03

Fig. 1  
 Fig. 3  
 Fig. 5

PINZETTEN FORCEPS PINZAS PINCES PINZE

Zahnpinzetten, Nahtpinzetten  
 Cotton and Dressing Pliers, Suture Tweezers  
 Pinzas para algodón y curaciones, Pinzas de sutura  
 Précelles (Brucelles) pour coton, Pincés de suture  
 Pinze per cotone, Pinze per sutura



2/3

**LANDGRAF**  
 15,0 cm/6"



Fig. 1  
 AB 981/01



Fig. 2  
 AB 981/02

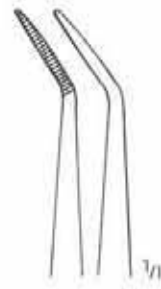

Fig. 3  
 AB 981/03

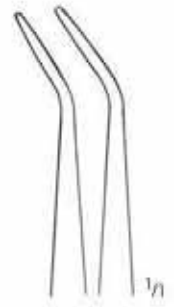

Fig. 4  
 AB 981/04



2/3

**PERRY**  
 12,5 cm/5"



Fig. 1  
 AB 983/01

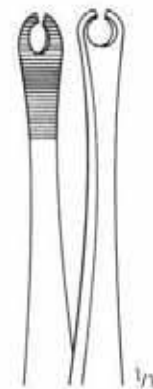

Fig. 2  
 AB 983/02



2/3

15,0 cm/6"



AB 988/01

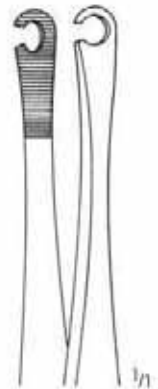

AB 988/02

AA  
 AB  
 AC  
 AD  
 AE  
 AF  
 AG  
 AH  
 AI  
 AJ  
 AK  
 AL  
 AM  
 AN  
 AO  
 AP  
 AQ  
 AR  
 AS  
 AT  
 AU  
 AV  
 AW  
 AX  
 AY  
 AZ

**AB** PINZETTEN FORCEPS PINZAS PINCES PINZE

Markierungspinzetten, Artikulationspapier-Pinzetten  
 Pocket Markers, Articulating Paper Forceps  
 Pinzas para bolsas, Pinzas para papel de articular  
 Pincés pour cul-de-sac, Pincés pour papier à articulation  
 Pinze per marcazione, Pinze per carta di articolazione

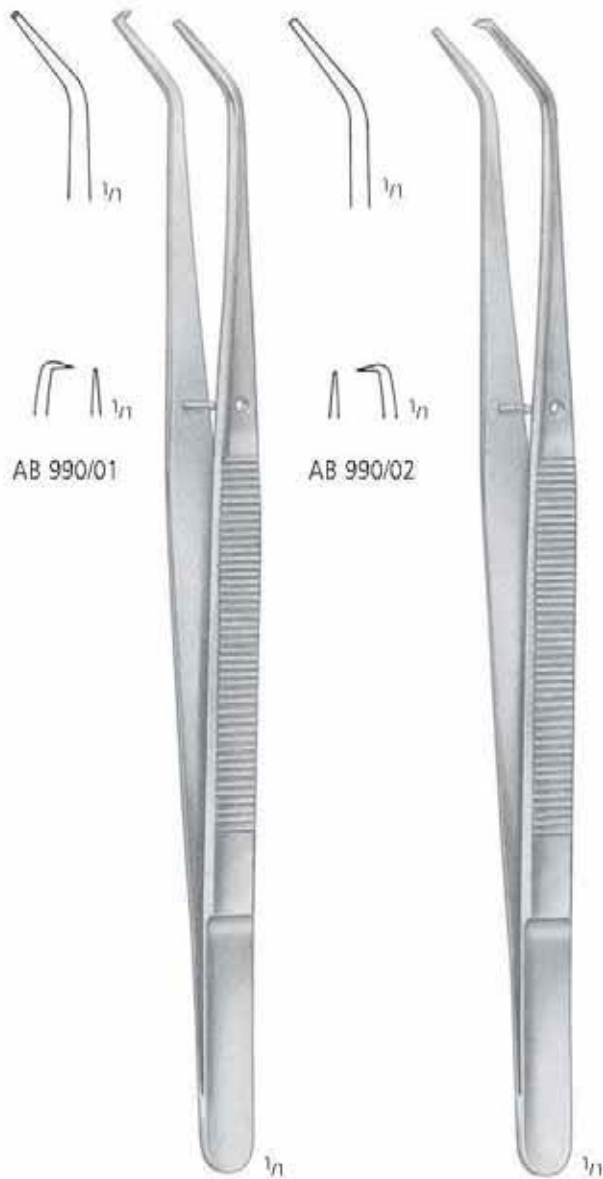

AB 990/01

AB 990/02

**CRANE-KAPLAN**

AB 990/01  
15,0 cm/6"

AB 990/02  
15,0 cm/6"

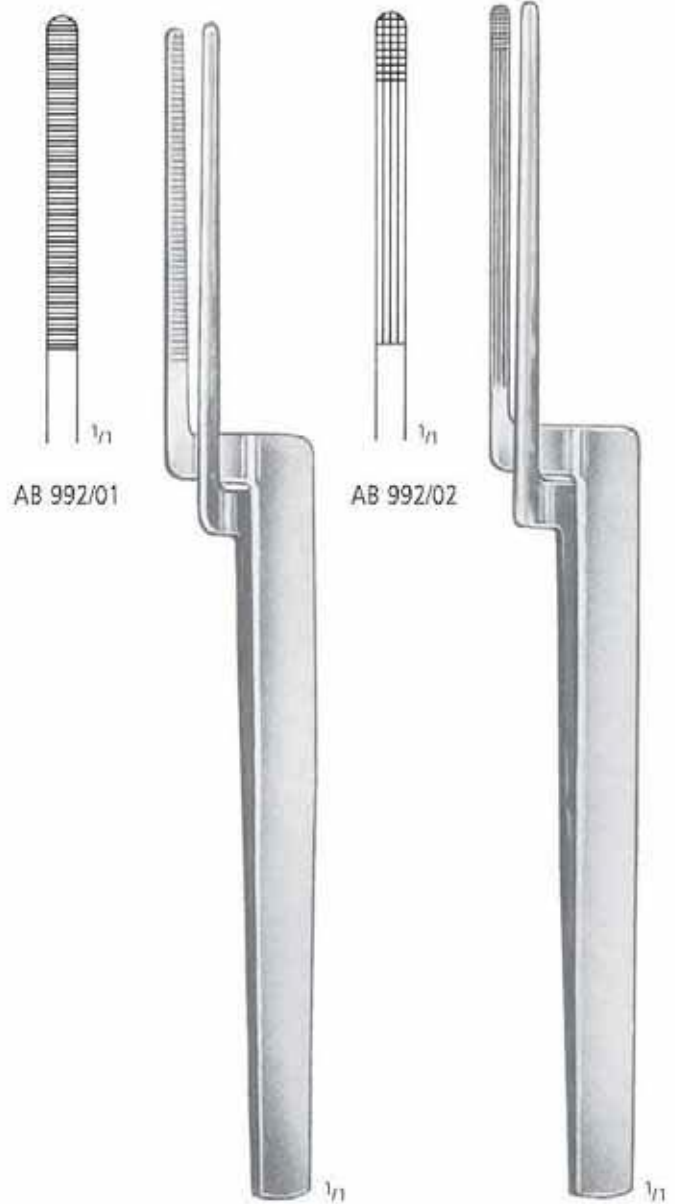

AB 992/01

AB 992/02

**MILLER**  
15,0 cm/6"



---

SCHEREN  
SCISSORS  
TIJERAS  
CISEAUX  
FORBICI

AC

nopa<sup>®</sup> instruments





nopa® SC  
**SUPER CUT**



**SUPER CUT**

#### Besonderheit:

**nopa Super Cut** Scheren haben eine rasierklingenscharfe Schneide, kombiniert mit einer mikrogezahnten Schneide.

>> Diese Scheren sind durch schwarze Ringe gekennzeichnet.

#### Features:

**nopa Super Cut** scissors have a razor-like edge combined with one micro serrated blade.

>> Black rings for easy identification.

#### Verfügbare Modelle / Available Patterns

Im Katalog durch \* markiert. / Marked in catalog with \*.

AC	020/13	SC	STANDARD OPER.SCS STR. SH/BL	13,0	CM	SC
AC	020/14	SC	STANDARD OPER.SCS STR. SH/BL	14,0	CM	SC
AC	021/13	SC	STANDARD OPER.SCS CVD. SH/BL	13,0	CM	SC
AC	021/14	SC	STANDARD OPER.SCS CVD. SH/BL	14,0	CM	SC
AC	070/14	SC	MAYO OPER. SCS STR. BL/BL	14,5	CM	SC
AC	070/17	SC	MAYO OPER. SCS STR. BL/BL	17,0	CM	SC
AC	070/23	SC	MAYO OPER. SCS STR. BL/BL	23,0	CM	SC
AC	071/14	SC	MAYO OPER. SCS CVD. BL/BL	14,5	CM	SC
AC	071/17	SC	MAYO OPER. SCS CVD. BL/BL	17,0	CM	SC
AC	071/23	SC	MAYO OPER. SCS CVD. BL/BL	23,0	CM	SC
AC	073/17	SC	MAYO-STILLE OPER. SCS CVD. BL/BL	17,0	CM	SC
AC	100/14	SC	METZENBAUM SCS STR. BL/BL	14,0	CM	SC
AC	101/14	SC	METZENBAUM SCS CVD. BL/BL	14,0	CM	SC
AC	110/18	SC	METZENBAUM-NELSON SCS STR. BL/BL	18,0	CM	SC
AC	110/20	SC	METZENBAUM-NELSON SCS STR. BL/BL	20,0	CM	SC
AC	110/23	SC	METZENBAUM-NELSON SCS STR. BL/BL	23,0	CM	SC
AC	111/18	SC	METZENBAUM-NELSON SCS CVD. BL/BL	18,0	CM	SC
AC	111/20	SC	METZENBAUM-NELSON SCS CVD. BL/BL	20,0	CM	SC
AC	111/23	SC	METZENBAUM-NELSON SCS CVD. BL/BL	23,0	CM	SC
AC	141/14	SC	METZENBAUM-DELICATE SCS BL/BL CVD.	14,5	CM	SC
AC	151/18	SC	METZENBAUM-DELICATE SCS BL/BL CVD.	18,0	CM	SC
AC	214/15	SC	REYNOLDS DISS. SCS STR. SH/SH	15,0	CM	SC
AC	214/18	SC	REYNOLDS DISS. SCS CVD. SH/SH	18,0	CM	SC
AC	450/11	SC	IRIS SCS STR. SH/SH	11,5	CM	SC
AC	451/11	SC	IRIS SCS CVD. SH/SH	11,5	CM	SC
AC	460/11	SC	STRABISMUS SCS STR. BL/BL	11,5	CM	SC
AC	461/11	SC	STRABISMUS SCS CVD. BL/BL	11,5	CM	SC
AC	476/11	SC	STEVENS TENOTOMY SCS STR. BL/BL	11,5	CM	SC
AC	477/11	SC	STEVENS TENOTOMY SCS CVD. BL/BL	11,5	CM	SC

Chirurgische Scheren  
Operating Scissors  
Tijeras para cirugía  
Ciseaux à chirurgie  
Forbici per chirurgia



**STANDARD**

Fig.1  
gerade  
straight  
rectas  
droits  
rette

- |           |   |
|-----------|---|
| AC 010/10 | 10,5 cm/4 <sup>1</sup> / <sub>4</sub> " |
| AC 010/11 | 11,5 cm/4 <sup>1</sup> / <sub>2</sub> " |
| AC 010/13 | 13,0 cm/5"                              |
| AC 010/14 | 14,5 cm/5 <sup>3</sup> / <sub>4</sub> " |
| AC 010/15 | 15,5 cm/6"                              |
| AC 010/16 | 16,5 cm/6 <sup>1</sup> / <sub>2</sub> " |
| AC 010/17 | 17,5 cm/7"                              |
| AC 010/18 | 18,5 cm/7 <sup>1</sup> / <sub>2</sub> " |
| AC 010/20 | 20,0 cm/8"                              |



**STANDARD**

Fig.1  
gebogen  
curved  
curvas  
courbes  
curve

- |           |   |
|-----------|---|
| AC 011/10 | 10,5 cm/4 <sup>1</sup> / <sub>4</sub> " |
| AC 011/11 | 11,5 cm/4 <sup>1</sup> / <sub>2</sub> " |
| AC 011/13 | 13,0 cm/5"                              |
| AC 011/14 | 14,5 cm/5 <sup>3</sup> / <sub>4</sub> " |
| AC 011/15 | 15,5 cm/6"                              |
| AC 011/16 | 16,5 cm/6 <sup>1</sup> / <sub>2</sub> " |
| AC 011/17 | 17,5 cm/7"                              |
| AC 011/18 | 18,5 cm/7 <sup>1</sup> / <sub>2</sub> " |
| AC 011/20 | 20,0 cm/8"                              |



**STANDARD**

Fig.2  
gerade  
straight  
rectas  
droits  
rette

- |            |   |
|------------|---|
| AC 020/10  | 10,5 cm/4 <sup>1</sup> / <sub>4</sub> " |
| AC 020/11  | 11,5 cm/4 <sup>1</sup> / <sub>2</sub> " |
| AC 020/13* | 13,0 cm/5"                              |
| AC 020/14* | 14,5 cm/5 <sup>3</sup> / <sub>4</sub> " |
| AC 020/15  | 15,5 cm/6"                              |
| AC 020/16  | 16,5 cm/6 <sup>1</sup> / <sub>2</sub> " |
| AC 020/17  | 17,5 cm/7"                              |
| AC 020/18  | 18,5 cm/7 <sup>1</sup> / <sub>2</sub> " |
| AC 020/20  | 20,0 cm/8"                              |



**STANDARD**

Fig.2  
gebogen  
curved  
curvas  
courbes  
curve

- |            |   |
|------------|---|
| AC 021/10  | 10,5 cm/4 <sup>1</sup> / <sub>4</sub> " |
| AC 021/11  | 11,5 cm/4 <sup>1</sup> / <sub>2</sub> " |
| AC 021/13* | 13,0 cm/5"                              |
| AC 021/14* | 14,5 cm/5 <sup>3</sup> / <sub>4</sub> " |
| AC 021/15  | 15,5 cm/6"                              |
| AC 021/16  | 16,5 cm/6 <sup>1</sup> / <sub>2</sub> " |
| AC 021/17  | 17,5 cm/7"                              |
| AC 021/18  | 18,5 cm/7 <sup>1</sup> / <sub>2</sub> " |
| AC 021/20  | 20,0 cm/8"                              |



**STANDARD**

Fig.3  
gerade  
straight  
rectas  
droits  
rette

- |           |   |
|-----------|---|
| AC 030/10 | 10,5 cm/4 <sup>1</sup> / <sub>4</sub> " |
| AC 030/11 | 11,5 cm/4 <sup>1</sup> / <sub>2</sub> " |
| AC 030/13 | 13,0 cm/5"                              |
| AC 030/14 | 14,5 cm/5 <sup>3</sup> / <sub>4</sub> " |
| AC 030/15 | 15,5 cm/6"                              |
| AC 030/16 | 16,5 cm/6 <sup>1</sup> / <sub>2</sub> " |
| AC 030/17 | 17,5 cm/7"                              |
| AC 030/18 | 18,5 cm/7 <sup>1</sup> / <sub>2</sub> " |
| AC 030/20 | 20,0 cm/8"                              |



**STANDARD**

Fig.3  
gebogen  
curved  
curvas  
courbes  
curve

- |           |   |
|-----------|---|
| AC 031/10 | 10,5 cm/4 <sup>1</sup> / <sub>4</sub> " |
| AC 031/11 | 11,5 cm/4 <sup>1</sup> / <sub>2</sub> " |
| AC 031/13 | 13,0 cm/5"                              |
| AC 031/14 | 14,5 cm/5 <sup>3</sup> / <sub>4</sub> " |
| AC 031/15 | 15,5 cm/6"                              |
| AC 031/16 | 16,5 cm/6 <sup>1</sup> / <sub>2</sub> " |
| AC 031/17 | 17,5 cm/7"                              |
| AC 031/18 | 18,5 cm/7 <sup>1</sup> / <sub>2</sub> " |
| AC 031/20 | 20,0 cm/8"                              |



SCHEREN SCISSORS TIJERAS CISEAUX FORBICI

Chirurgische Scheren  
Operating Scissors  
Tijeras para cirugía  
Ciseaux à chirurgie  
Forbici per chirurgia



Original 13,0 cm



**GRAZIL**

Fig.1  
gerade  
straight  
rectas  
droits  
rette

AC 040/13  
AC 040/14

13,0 cm/5"  
14,5 cm/5<sup>3</sup>/<sub>4</sub>"

Original 13,0 cm



**GRAZIL**

Fig.1  
gebogen  
curved  
curvas  
courbes  
curve

AC 041/13  
AC 041/14



Original 14,5 cm



**GRAZIL**

Fig.2  
gerade  
straight  
rectas  
droits  
rette

AC 042/13  
AC 042/14

13,0 cm/5"  
14,5 cm/5<sup>3</sup>/<sub>4</sub>"

Original 14,5 cm



**GRAZIL**

Fig.2  
gebogen  
curved  
curvas  
courbes  
curve

AC 043/13  
AC 043/14



Original 14,5 cm



**GRAZIL**

Fig.3  
gerade  
straight  
rectas  
droits  
rette

AC 046/13  
AC 046/14

13,0 cm/5"  
14,5 cm/5<sup>3</sup>/<sub>4</sub>"

Original 14,5 cm



**GRAZIL**

Fig.3  
gebogen  
curved  
curvas  
courbes  
curve

AC 047/13  
AC 047/14



AA  
AB  
AC  
AD  
AE  
AF  
AG  
AH  
AI  
AJ  
AK  
AL  
AM  
AN  
AO  
AP  
AQ  
AR  
AS  
AT  
AU  
AV  
AW  
AX  
AY  
AZ  
BA  
BB  
BC  
BD  
BE  
BF  
BG  
BH  
BI  
BJ  
BK  
BL  
BM  
BN  
BO  
BP  
BQ  
BR  
BS  
BT  
BU  
BV  
BW  
BX  
BY  
BZ  
CA  
CB  
CC  
CD  
CE  
CF  
CG  
CH  
CI  
CJ  
CK  
CL  
CM  
CN  
CO  
CP  
CQ  
CR  
CS  
CT  
CU  
CV  
CW  
CX  
CY  
CZ  
DA  
DB  
DC  
DD  
DE  
DF  
DG  
DH  
DI  
DJ  
DK  
DL  
DM  
DN  
DO  
DP  
DQ  
DR  
DS  
DT  
DU  
DV  
DW  
DX  
DY  
DZ  
EA  
EB  
EC  
ED  
EE  
EF  
EG  
EH  
EI  
EJ  
EK  
EL  
EM  
EN  
EO  
EP  
EQ  
ER  
ES  
ET  
EU  
EV  
EW  
EX  
EY  
EZ  
FA  
FB  
FC  
FD  
FE  
FF  
FG  
FH  
FI  
FJ  
FK  
FL  
FM  
FN  
FO  
FP  
FQ  
FR  
FS  
FT  
FU  
FV  
FW  
FX  
FY  
FZ  
GA  
GB  
GC  
GD  
GE  
GF  
GG  
GH  
GI  
GJ  
GK  
GL  
GM  
GN  
GO  
GP  
GQ  
GR  
GS  
GT  
GU  
GV  
GW  
GX  
GY  
GZ  
HA  
HB  
HC  
HD  
HE  
HF  
HG  
HH  
HI  
HJ  
HK  
HL  
HM  
HN  
HO  
HP  
HQ  
HR  
HS  
HT  
HU  
HV  
HW  
HX  
HY  
HZ  
IA  
IB  
IC  
ID  
IE  
IF  
IG  
IH  
II  
IJ  
IK  
IL  
IM  
IN  
IO  
IP  
IQ  
IR  
IS  
IT  
IU  
IV  
IW  
IX  
IY  
IZ  
JA  
JB  
JC  
JD  
JE  
JF  
JG  
JH  
JI  
JJ  
JK  
JL  
JM  
JN  
JO  
JP  
JQ  
JR  
JS  
JT  
JU  
JV  
JW  
JX  
JY  
JZ  
KA  
KB  
KC  
KD  
KE  
KF  
KG  
KH  
KI  
KJ  
KK  
KL  
KM  
KN  
KO  
KP  
KQ  
KR  
KS  
KT  
KU  
KV  
KW  
KX  
KY  
KZ  
LA  
LB  
LC  
LD  
LE  
LF  
LG  
LH  
LI  
LJ  
LK  
LL  
LM  
LN  
LO  
LP  
LQ  
LR  
LS  
LT  
LU  
LV  
LW  
LX  
LY  
LZ  
MA  
MB  
MC  
MD  
ME  
MF  
MG  
MH  
MI  
MJ  
MK  
ML  
MM  
MN  
MO  
MP  
MQ  
MR  
MS  
MT  
MU  
MV  
MW  
MX  
MY  
MZ  
NA  
NB  
NC  
ND  
NE  
NF  
NG  
NH  
NI  
NJ  
NK  
NL  
NM  
NN  
NO  
NP  
NQ  
NR  
NS  
NT  
NU  
NV  
NW  
NX  
NY  
NZ  
OA  
OB  
OC  
OD  
OE  
OF  
OG  
OH  
OI  
OJ  
OK  
OL  
OM  
ON  
OO  
OP  
OQ  
OR  
OS  
OT  
OU  
OV  
OW  
OX  
OY  
OZ  
PA  
PB  
PC  
PD  
PE  
PF  
PG  
PH  
PI  
PJ  
PK  
PL  
PM  
PN  
PO  
PP  
PQ  
PR  
PS  
PT  
PU  
PV  
PW  
PX  
PY  
PZ  
QA  
QB  
QC  
QD  
QE  
QF  
QG  
QH  
QI  
QJ  
QK  
QL  
QM  
QN  
QO  
QP  
QQ  
QR  
QS  
QT  
QU  
QV  
QW  
QX  
QY  
QZ  
RA  
RB  
RC  
RD  
RE  
RF  
RG  
RH  
RI  
RJ  
RK  
RL  
RM  
RN  
RO  
RP  
RQ  
RR  
RS  
RT  
RU  
RV  
RW  
RX  
RY  
RZ  
SA  
SB  
SC  
SD  
SE  
SF  
SG  
SH  
SI  
SJ  
SK  
SL  
SM  
SN  
SO  
SP  
SQ  
SR  
SS  
ST  
SU  
SV  
SW  
SX  
SY  
SZ  
TA  
TB  
TC  
TD  
TE  
TF  
TG  
TH  
TI  
TJ  
TK  
TL  
TM  
TN  
TO  
TP  
TQ  
TR  
TS  
TT  
TU  
TV  
TW  
TX  
TY  
TZ  
UA  
UB  
UC  
UD  
UE  
UF  
UG  
UH  
UI  
UJ  
UK  
UL  
UM  
UN  
UO  
UP  
UQ  
UR  
US  
UT  
UU  
UV  
UW  
UX  
UY  
UZ  
VA  
VB  
VC  
VD  
VE  
VF  
VG  
VH  
VI  
VJ  
VK  
VL  
VM  
VN  
VO  
VP  
VQ  
VR  
VS  
VT  
VU  
VV  
VW  
VX  
VY  
VZ  
WA  
WB  
WC  
WD  
WE  
WF  
WG  
WH  
WI  
WJ  
WK  
WL  
WM  
WN  
WO  
WP  
WQ  
WR  
WS  
WT  
WU  
WV  
WW  
WX  
WY  
WZ  
XA  
XB  
XC  
XD  
XE  
XF  
XG  
XH  
XI  
XJ  
XK  
XL  
XM  
XN  
XO  
XP  
XQ  
XR  
XS  
XT  
XU  
XV  
XW  
XX  
XY  
XZ  
YA  
YB  
YC  
YD  
YE  
YF  
YG  
YH  
YI  
YJ  
YK  
YL  
YM  
YN  
YO  
YP  
YQ  
YR  
YS  
YT  
YU  
YV  
YW  
YX  
YZ  
ZA  
ZB  
ZC  
ZD  
ZE  
ZF  
ZG  
ZH  
ZI  
ZJ  
ZK  
ZL  
ZM  
ZN  
ZO  
ZP  
ZQ  
ZR  
ZS  
ZT  
ZU  
ZV  
ZW  
ZX  
ZY  
ZZ

**AC** SCHEREN SCISSORS TIJERAS CISEAUX FORBICI

Chirurgische Scheren  
 Operating Scissors  
 Tijeras para cirugía  
 Ciseaux à chirurgie  
 Forbici per chirurgia



Inzisionsscheren  
 Incision Scissors  
 Tijeras para incision  
 Ciseaux à incision  
 Forbici per incisioni

AC 052/13 = 13,0 cm/5"  
 AC 052/14 = 14,5 cm/5<sup>3</sup>/<sub>4</sub>"



AC 054/15  
 15,5 cm/6"



**RICHTER**  
 AC 056/14  
 14,5 cm/5<sup>3</sup>/<sub>4</sub>"

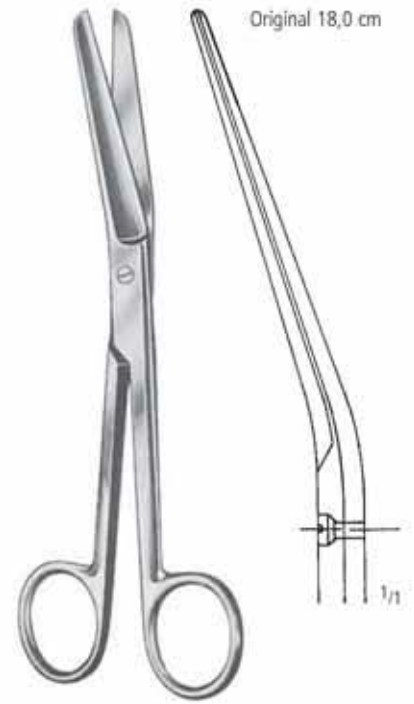

**FERGUSSON**  
 AC 058/16 = 16,5 cm/6<sup>1</sup>/<sub>2</sub>"  
 AC 058/18 = 18,0 cm/7"



**DEAVER**  
 AC 060/14  
 14,0 cm/5<sup>1</sup>/<sub>2</sub>"



AC 061/14



AC 062/15

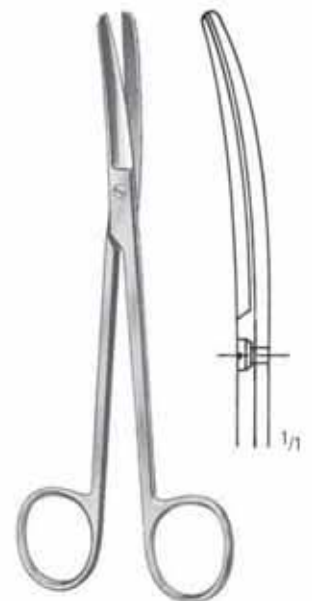

**MIXTER**  
 15,5 cm/6" AC 063/15



SCHEREN SCISSORS TIJERAS CISEAUX FORBICI

Chirurgische und Gynäkologische Scheren  
 Operating and Gynecological Scissors  
 Tijeras para cirugía y ginecología  
 Ciseaux à chirurgie et à gynécologie  
 Forbici per chirurgia e ginecologia

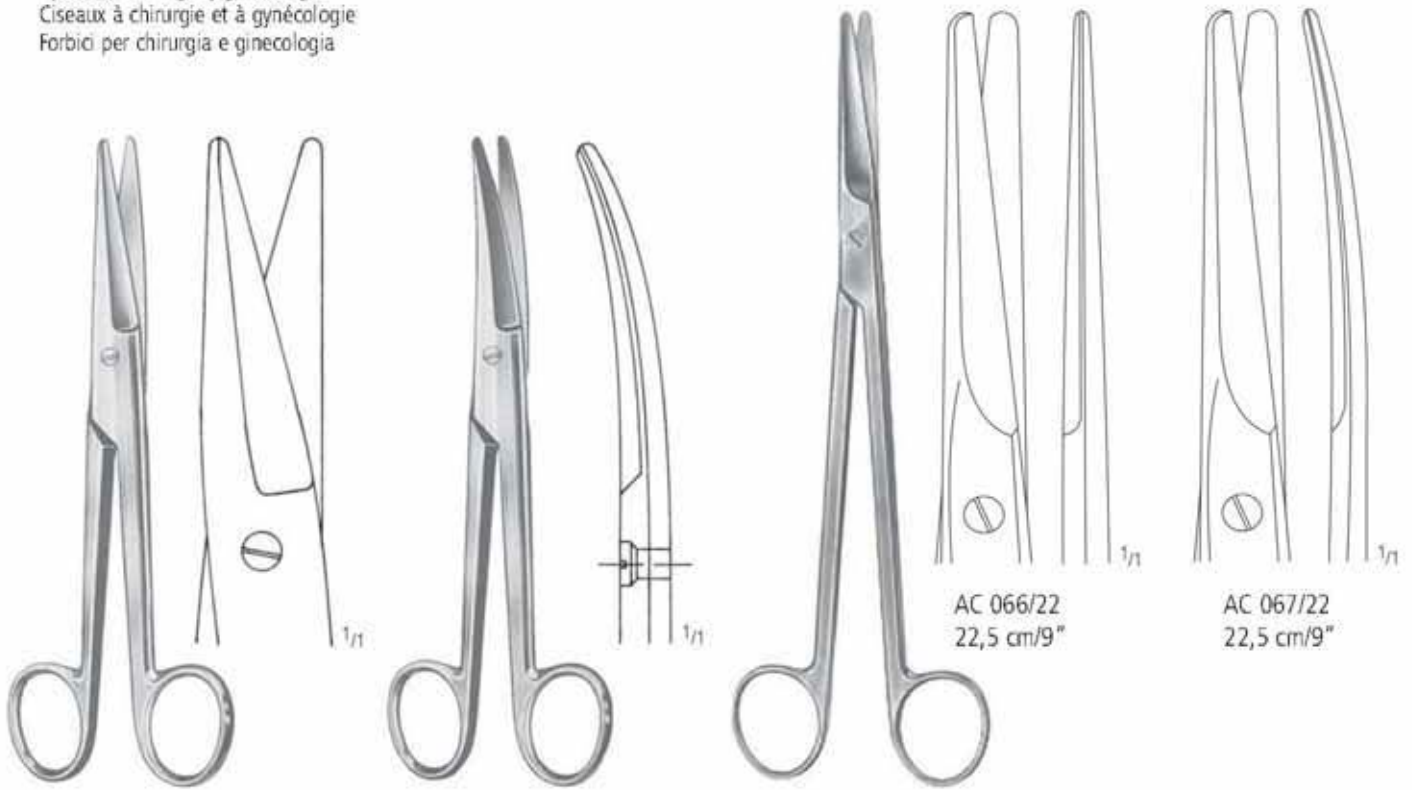

AC 064/17 **MAYO-NOBLE** 17,0 cm/6<sup>3</sup>/<sub>4</sub>" AC 065/17

**MAYO-HARRINGTON**

AC 066/22  
22,5 cm/9"

AC 067/22  
22,5 cm/9"



**MAYO**

**MAYO-STILLE**

14,5 cm/5 <sup>3</sup> / <sub>4</sub> "	AC 070/14*	AC 071/14*		
15,0 cm/6"			AC 072/15	AC 073/15
17,0 cm/6 <sup>3</sup> / <sub>4</sub> "	AC 070/17*	AC 071/17*	AC 072/17	AC 073/17*
19,5 cm/7 <sup>3</sup> / <sub>4</sub> "			AC 072/19	AC 073/19
21,0 cm/8 <sup>1</sup> / <sub>4</sub> "			AC 072/21	AC 073/21
23,0 cm/9"	AC 070/23*	AC 071/23*		
28,0 cm/11"	AC 070/28	AC 071/28		

AA  
AB  
AC  
AD  
AE  
AF  
AG  
AH  
AI  
AJ  
AK  
AL  
AM  
AN  
AO  
AP  
AQ  
AR  
AS  
AT  
AU  
AV  
AW  
AX  
AY  
AZ

**AC** SCHEREN SCISSORS TIJERAS CISEAUX FORBICI

Gynäkologische und Bauchdecken-Scheren  
 Gynecological and Abdominal Scissors  
 Tijeras para ginecología y Tijeras abdominales  
 Ciseaux à gynécologie et Ciseaux abdominaux  
 Forbici per ginecologia e Forbici addominali



**DOYEN**  
 AC 080/16  
 16,0 cm/6<sup>1</sup>/<sub>4</sub>"

**DOYEN**  
 AC 082/16  
 16,0 cm/6<sup>1</sup>/<sub>4</sub>"

**DOYEN**  
 AC 083/16  
 16,0 cm/6<sup>1</sup>/<sub>4</sub>"



**DOYEN**  
 AC 084/18  
 17,5 cm/7"

**DOYEN**  
 AC 085/18  
 17,5 cm/7"

Fistelscheren  
 Fistula Scissors  
 Tijeras para fistulas  
 Ciseaux pour fistules  
 Forbici per fistole



**KELLY**  
 AC 086/16  
 16,0 cm/6<sup>1</sup>/<sub>4</sub>"

**KELLY**  
 AC 086/18  
 18,0 cm/7"

AC 087/16  
 AC 087/18



**WERTHEIM**  
 14,5 cm/5<sup>3</sup>/<sub>4</sub>" AC 089/14  
 19,5 cm/7<sup>3</sup>/<sub>4</sub>" AC 089/19  
 22,5 cm/9" AC 089/22

SCHEREN SCISSORS TIJERAS CISEAUX FORBICI

Gynäkologische Scheren  
Gynecological Scissors  
Tijeras para ginecología  
Ciseaux à gynécologie  
Forbici per ginecologia



20,0 cm/8"  
23,0 cm/9" AC 090/20  
AC 090/23



AC 092/20  
AC 092/23



AC 094/20  
AC 094/23

**SIMS**

gerade  
straight  
rectas  
droits  
rette



AC 091/20  
AC 091/23



Original 20,0 cm



AC 093/20  
AC 093/23

**SIMS**

gebogen  
curved  
curvas  
courbes  
curve



AC 095/20  
AC 095/23



**DUBOIS**  
AC 096/27  
27,0 cm/10<sup>3</sup>/<sub>4</sub>"



**DUBOIS**  
AC 097/27  
27,0 cm/10<sup>3</sup>/<sub>4</sub>"

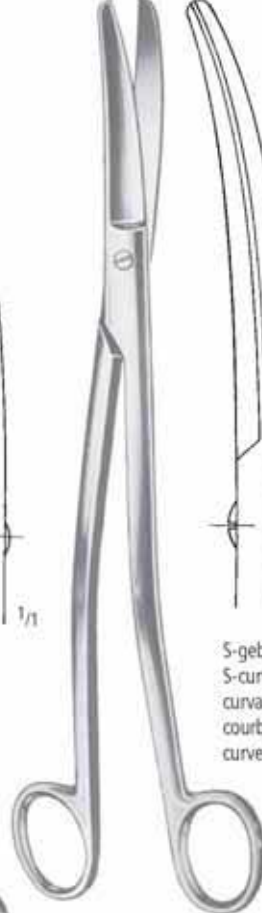
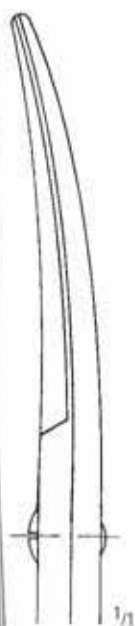

**SIEBOLD**  
AC 098/24  
24,0 cm/9<sup>1</sup>/<sub>2</sub>"



S-gebogen  
S-curved  
curva forma S  
courbes en S  
curve in S



**CARDINALE**  
AC 099/28  
28,0 cm/11"

AA  
AB  
AC  
AD  
AE  
AF  
AK  
AL  
AM  
AO  
AP  
AR  
KA  
KD  
KU  
KY

**AC** SCHEREN SCISSORS TIJERAS CISEAUX FORBICI

Präparierscheren  
Dissecting Scissors  
Tijeras para preparaciones  
Ciseaux à dissection  
Forbici per preparazioni

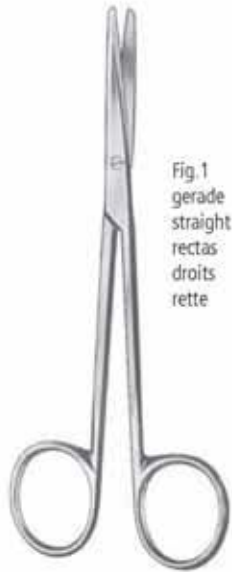

Fig. 1  
gerade  
straight  
rectas  
droits  
rette

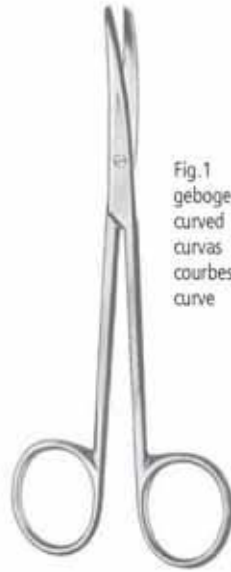

Fig. 1  
gebogen  
curved  
curvas  
courbes  
curve

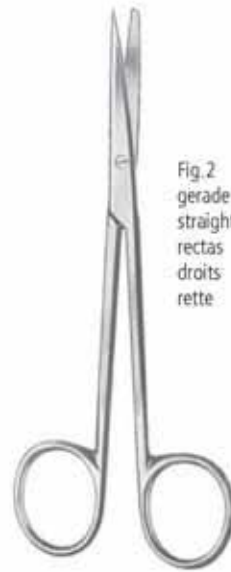

Fig. 2  
gerade  
straight  
rectas  
droits  
rette



Fig. 2  
gebogen  
curved  
curvas  
courbes  
curve



**METZENBAUM**

AC 100/14\*  
14,5 cm/5<sup>3</sup>/<sub>4</sub>"

AC 101/14\*  
14,5 cm/5<sup>3</sup>/<sub>4</sub>"

**METZENBAUM**

AC 102/14  
14,5 cm/5<sup>3</sup>/<sub>4</sub>"

AC 103/14  
14,5 cm/5<sup>3</sup>/<sub>4</sub>"

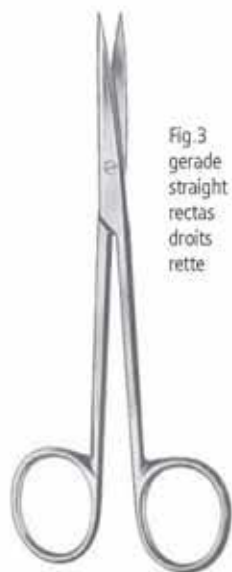

Fig. 3  
gerade  
straight  
rectas  
droits  
rette



Fig. 3  
gebogen  
curved  
curvas  
courbes  
curve



gerade  
straight  
rectas  
droits  
rette



gebogen  
curved  
curvas  
courbes  
curve



**METZENBAUM**

AC 104/14  
14,5 cm/5<sup>3</sup>/<sub>4</sub>"

AC 105/14  
14,5 cm/5<sup>3</sup>/<sub>4</sub>"

**METZENBAUM-BABY**

AC 108/11  
11,5 cm/4<sup>1</sup>/<sub>2</sub>"

AC 109/11



SCHEREN SCISSORS TIJERAS CISEAUX FORBICI

Präparierscheren  
Dissecting Scissors  
Tijeras para preparaciones  
Ciseaux à dissection  
Forbici per preparazioni

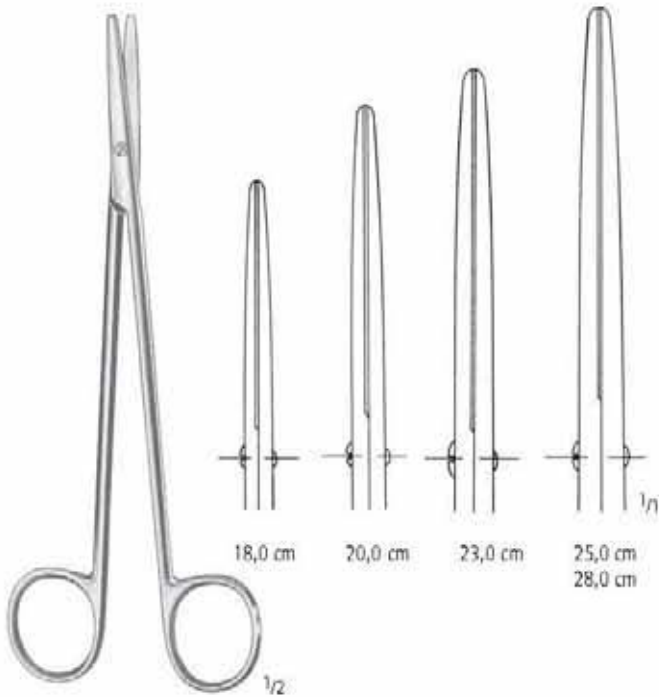

METZENBAUM-NELSON



METZENBAUM-NELSON



Fig. 1



Fig. 2



Fig. 3



18,0 cm/7"	AC 110/18*	AC 111/18*	AC 120/18	AC 121/18	AC 130/18	AC 131/18
20,0 cm/8"	AC 110/20*	AC 111/20*	AC 120/20	AC 121/20	AC 130/20	AC 131/20
23,0 cm/9"	AC 110/23*	AC 111/23*	AC 120/23	AC 121/23	AC 130/23	AC 131/23
25,0 cm/10"	AC 110/25	AC 111/25	AC 120/25	AC 121/25	AC 130/25	AC 131/25
28,0 cm/11"	AC 110/28	AC 111/28	AC 120/28	AC 121/28	AC 130/28	AC 131/28
30,0 cm/12"	AC 110/30	AC 111/30	AC 120/30	AC 121/30	AC 130/30	AC 131/30

AA  
AB  
AC  
AD  
AE  
AF  
AK  
AL  
AM  
AO  
AP  
AR  
KA  
KD  
KY

Präparierscheren, DELICATE  
 Dissecting Scissors, DELICATE  
 Tijeras para preparaciones, DELICATE  
 Ciseaux à dissection, DELICATE  
 Forbici per preparazioni, DELICATE

METZENBAUM-DELICATE

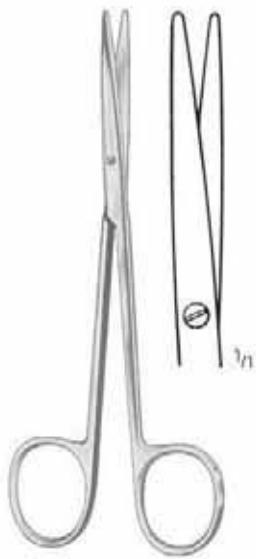

Fig. 1  
 AC 140/14  
 14,5 cm/5<sup>3</sup>/<sub>4</sub>"



Fig. 1  
 AC 141/14\*  
 14,5 cm/5<sup>3</sup>/<sub>4</sub>"



Fig. 3  
 AC 142/14  
 14,5 cm/5<sup>3</sup>/<sub>4</sub>"

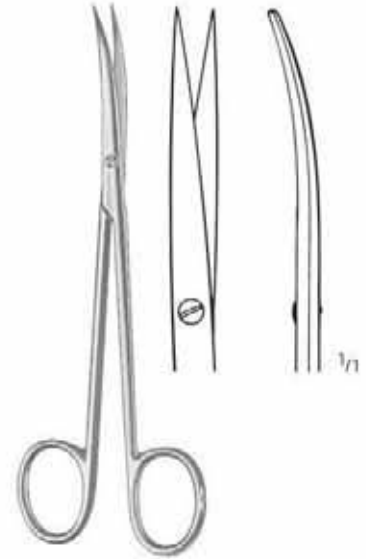

Fig. 3  
 AC 143/14  
 14,5 cm/5<sup>3</sup>/<sub>4</sub>"

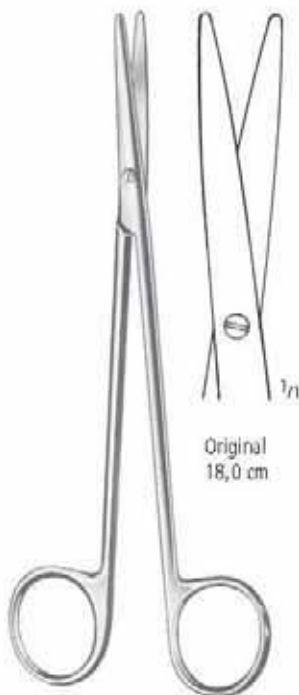

Fig. 1

Original  
 18,0 cm



Fig. 1

Original  
 18,0 cm

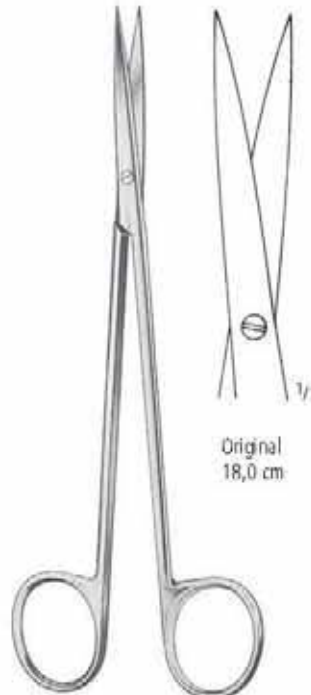

Fig. 3

Original  
 18,0 cm

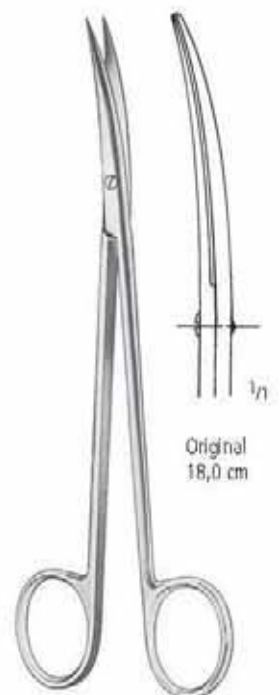

Fig. 3

Original  
 18,0 cm

18,0 cm/7"	AC 150/18	AC 151/18*	AC 152/18	AC 153/18
20,0 cm/8"	AC 150/20	AC 151/20	AC 152/20	AC 153/20
23,0 cm/9"	AC 150/23	AC 151/23	AC 152/23	AC 153/23
25,0 cm/10"			AC 152/25	AC 153/25
28,0 cm/11"			AC 152/28	AC 153/28
30,0 cm/12"			AC 152/30	AC 153/30



SCHEREN SCISSORS TIJERAS CISEAUX FORBICI

Präparierscheren  
Dissecting Scissors  
Tijeras para preparaciones  
Ciseaux à dissection  
Forbici per preparazioni

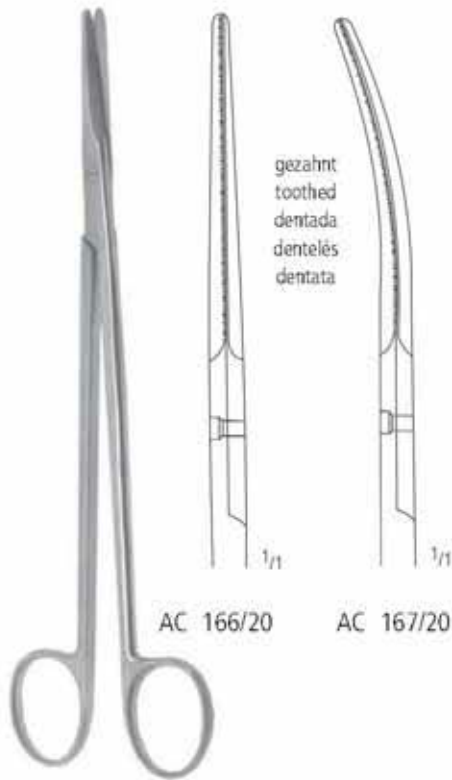

**GORNEY**  
19,5 cm/7<sup>3</sup>/<sub>4</sub>"

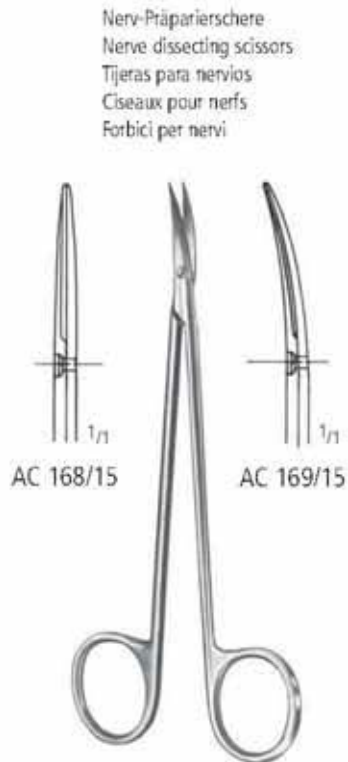

Nerv-Präparierschere  
Nerve dissecting scissors  
Tijeras para nervios  
Ciseaux pour nerfs  
Forbici per nervi

AC 168/15

AC 169/15

15,0 cm/6"



**LEXER**  
AC 170/16  
16,0 cm/6<sup>1</sup>/<sub>4</sub>"



**LEXER**  
AC 171/16  
16,0 cm/6<sup>1</sup>/<sub>4</sub>"



**FOMON**  
AC 173/13  
13,5 cm/5<sup>1</sup>/<sub>4</sub>"



**THOREK**  
AC 175/19  
19,0 cm/7<sup>1</sup>/<sub>2</sub>"



**LEXER-BABY**  
AC 176/10  
10,0 cm/4"

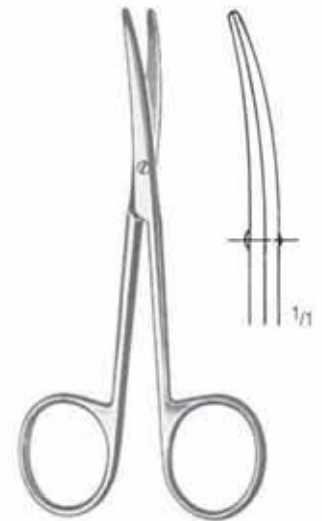

**LEXER-BABY**  
AC 177/10  
10,0 cm/4"

AA  
AB  
AC  
AD  
AE  
AF  
AG  
AH  
AI  
AJ  
AK  
AL  
AM  
AN  
AO  
AP  
AQ  
AR  
AS  
AT  
AU  
AV  
AW  
AX  
AY  
AZ  
BA  
BB  
BC  
BD  
BE  
BF  
BG  
BH  
BI  
BJ  
BK  
BL  
BM  
BN  
BO  
BP  
BQ  
BR  
BS  
BT  
BU  
BV  
BW  
BX  
BY  
CZ

Präparierscheren  
Dissecting Scissors  
Tijeras para preparaciones  
Ciseaux à dissection  
Forbici per preparazioni

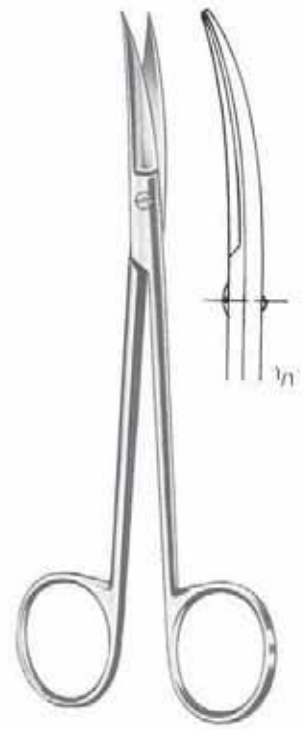
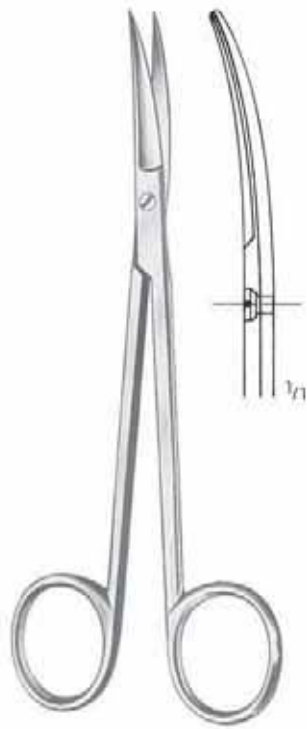

**SANVENERO**

AC 200/14  
14,0 cm/5 1/2"

AC 201/14  
14,0 cm/5 1/2"

**JOSEPH**

AC 204/14  
14,0 cm/5 1/2"

AC 205/14  
14,0 cm/5 1/2"

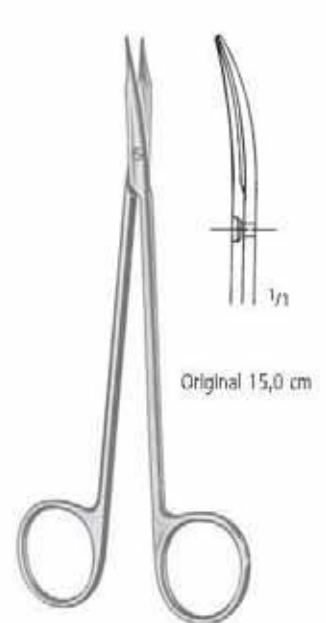
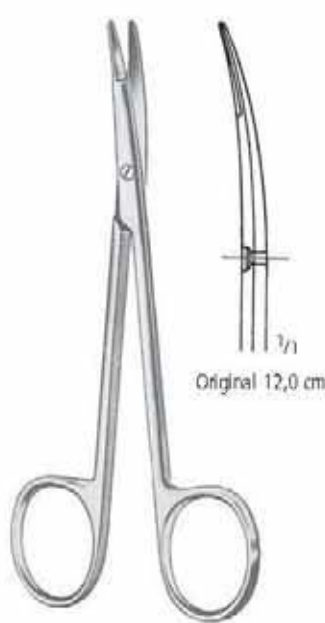

**KILNER (RAGNELL)**

AC 208/12	12,0 cm/4 3/4"	AC 210/12
AC 208/15	15,0 cm/6"	AC 210/15
AC 208/18	18,0 cm/7"	AC 210/18
AC 208/20	20,0 cm/8"	AC 210/20

**REYNOLDS**

AC 214/15*	15,0 cm/6"	AC 215/15
AC 214/18*	18,0 cm/7"	AC 215/18

SCHEREN SCISSORS TIJERAS CISEAUX FORBICI

Scheren für Gefäß-Chirurgie  
 Scissors for Vascular Surgery  
 Tijeras para cirugía vasculares  
 Ciseaux pour chirurgie vasculaire  
 Forbici per chirurgia vascolare

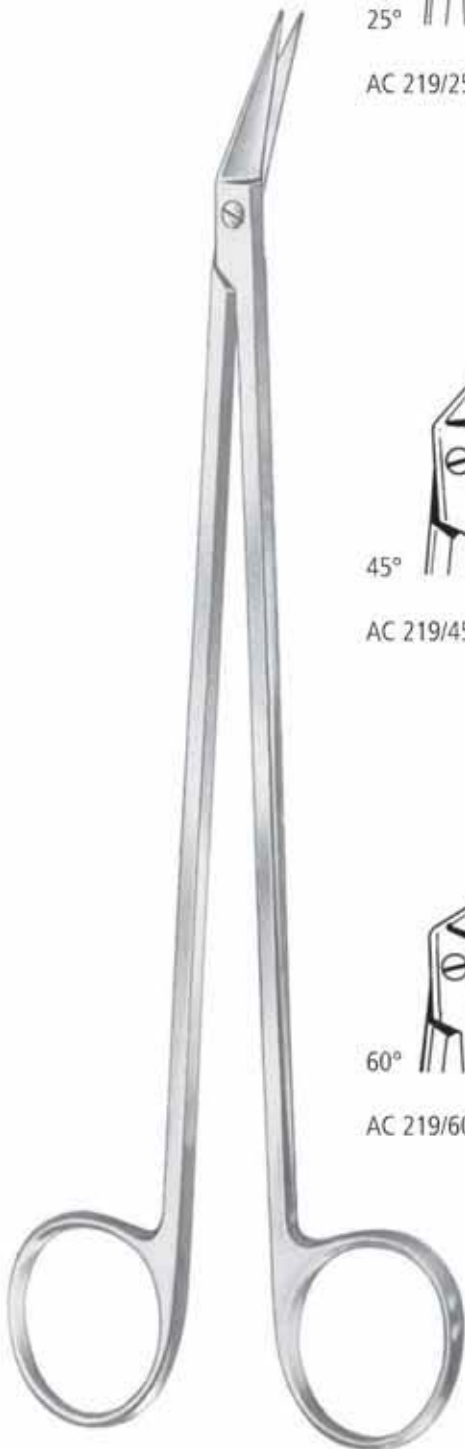

25°

AC 219/25



45°

AC 219/45



60°

AC 219/60

**POTTS-SMITH**  
 19,0 cm/7<sup>1</sup>/<sub>2</sub>"



25°

AC 220/16 17,0 cm/6<sup>3</sup>/<sub>4</sub>"  
 AC 220/19 19,0 cm/7<sup>1</sup>/<sub>2</sub>"  
 AC 220/23 23,0 cm/9"  
 AC 220/28 28,0 cm/11"



45°

AC 221/16 17,0 cm/6<sup>3</sup>/<sub>4</sub>"  
 AC 221/19 19,0 cm/7<sup>1</sup>/<sub>2</sub>"  
 AC 221/23 23,0 cm/9"  
 AC 221/28 28,0 cm/11"

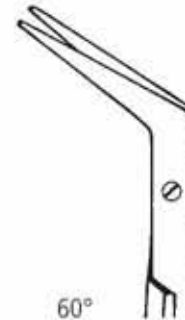

60°

AC 222/16 17,0 cm/6<sup>3</sup>/<sub>4</sub>"  
 AC 222/19 19,0 cm/7<sup>1</sup>/<sub>2</sub>"  
 AC 222/23 23,0 cm/9"  
 AC 222/28 28,0 cm/11"

**DE BAKEY**

AA  
 AB  
 AC  
 AD  
 AE  
 AF  
 AG  
 AH  
 AI  
 AJ  
 AK  
 AL  
 AM  
 AN  
 AO  
 AP  
 AQ  
 AR  
 AS  
 AT  
 AU  
 AV  
 AW  
 AX  
 AY  
 AZ



SCHEREN SCISSORS TIJERAS CISEAUX FORBICI

Scheren für Gefäß- und Neurochirurgie  
 Scissors for Vascular and Neuro Surgery  
 Tijeras para cirugía vasculares y neurocirugía  
 Ciseaux pour chirurgie vasculaire et neurochirurgie  
 Forbici vascolari, Forbici per neurochirurgia

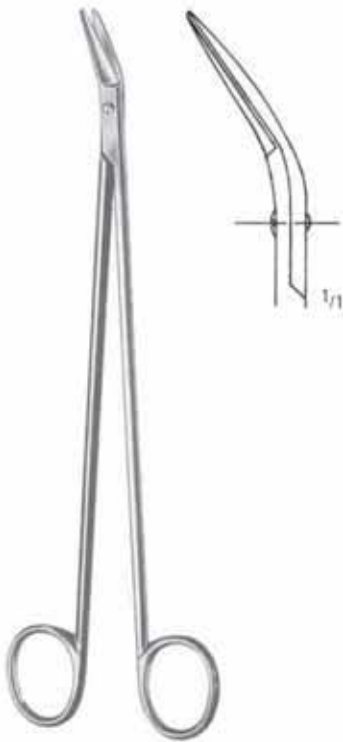

**POTTS-SMITH**  
 AC 227/19  
 19,5 cm/7<sup>3</sup>/<sub>4</sub>"

Coronar-Schere  
 Coronary-Scissors  
 Tijeras coronarias  
 Ciseaux coronaires  
 Forbici coronaria



AC 228/11  
 11,5 cm/4<sup>1</sup>/<sub>2</sub>"



AC 230/14  
 14,5 cm/5<sup>3</sup>/<sub>4</sub>"

geknöpft  
 probe pointed  
 con botón  
 boutonne  
 bottenuto



AC 231/22  
 22,0 cm/8<sup>3</sup>/<sub>4</sub>"

**STRULLY**



AC 232/22  
 22,0 cm/8<sup>3</sup>/<sub>4</sub>"



**DANDY**  
 AC 233/17  
 17,0 cm/6<sup>3</sup>/<sub>4</sub>"

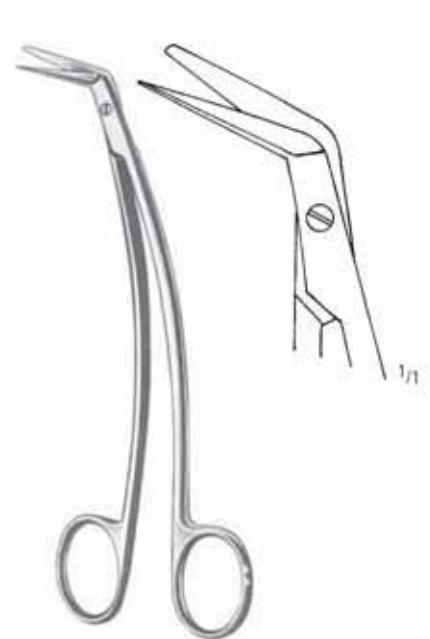

**FAVALORO**  
 AC 234/15  
 15,0 cm/6"

AA  
 AB  
 AC  
 AD  
 AE  
 AF  
 AG  
 AH  
 AI  
 AJ  
 AK  
 AL  
 AM  
 AN  
 AO  
 AP  
 AQ  
 AR  
 AS  
 AT  
 AU  
 AV  
 AW  
 AX  
 AY  
 AZ



**AC** SCHEREN SCISSORS TIJERAS CISEAUX FORBICI

Scheren für Gefäß- und Neurochirurgie  
 Scissors for Vascular and Neuro Surgery  
 Tijeras para cirugía vasculares y neurocirugía  
 Ciseaux pour chirurgie vasculaire et neurochirurgie  
 Forbici vascolari, Forbici per neurochirurgia

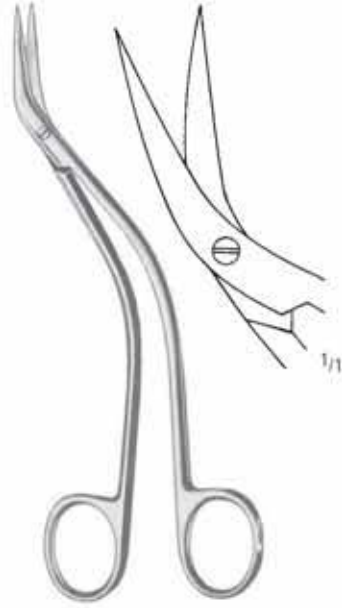
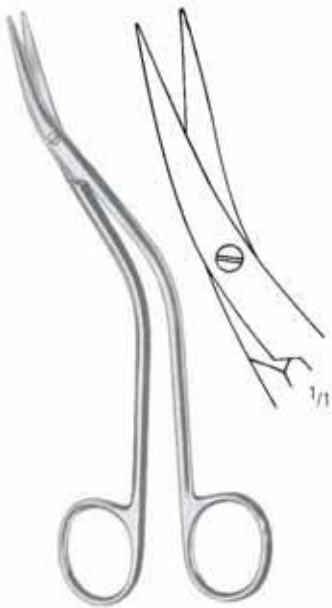

**DE BAKEY**

AC 235/15  
 15,5 cm/6"

AC 236/15  
 15,5 cm/6"



**POTTS-DE MARTEL**

AC 237/21  
 21,0 cm/8<sup>1</sup>/<sub>4</sub>"

**MILLS**

AC 238/21  
 21,0 cm/8<sup>1</sup>/<sub>4</sub>"

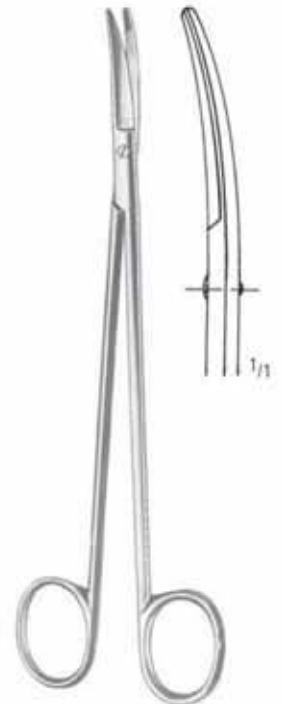
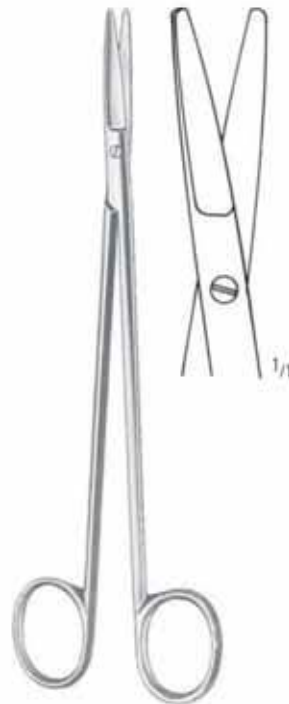

**SCHMIEDEN-TAYLOR**

14,5 cm/5<sup>1</sup>/<sub>2</sub>" AC 241/15  
 17,0 cm/6<sup>3</sup>/<sub>4</sub>" AC 241/17

**TOENNIS-ADSON**

AC 247/17  
 17,5 cm/7"

**TOENNIS**

AC 248/18 AC 249/18  
 18,0 cm/7" 18,0 cm/7"



SCHEREN SCISSORS TIJERAS CISEAUX FORBICI

Scheren für Gefäß- und Neurochirurgie  
 Scissors for Vascular and Neuro Surgery  
 Tijeras para cirugía vasculares y neurocirugía  
 Ciseaux pour chirurgie vasculaire et neurochirurgie  
 Forbici vascolari, Forbici per neurochirurgia

AA  
 AB  
 AC  
 AD  
 AE  
 AF  
 AG  
 AH  
 AI  
 AJ  
 AK  
 AL  
 AM  
 AN  
 AO  
 AP  
 AQ  
 AR  
 AS  
 AT  
 AU  
 AV  
 AW  
 AX  
 AY  
 AZ

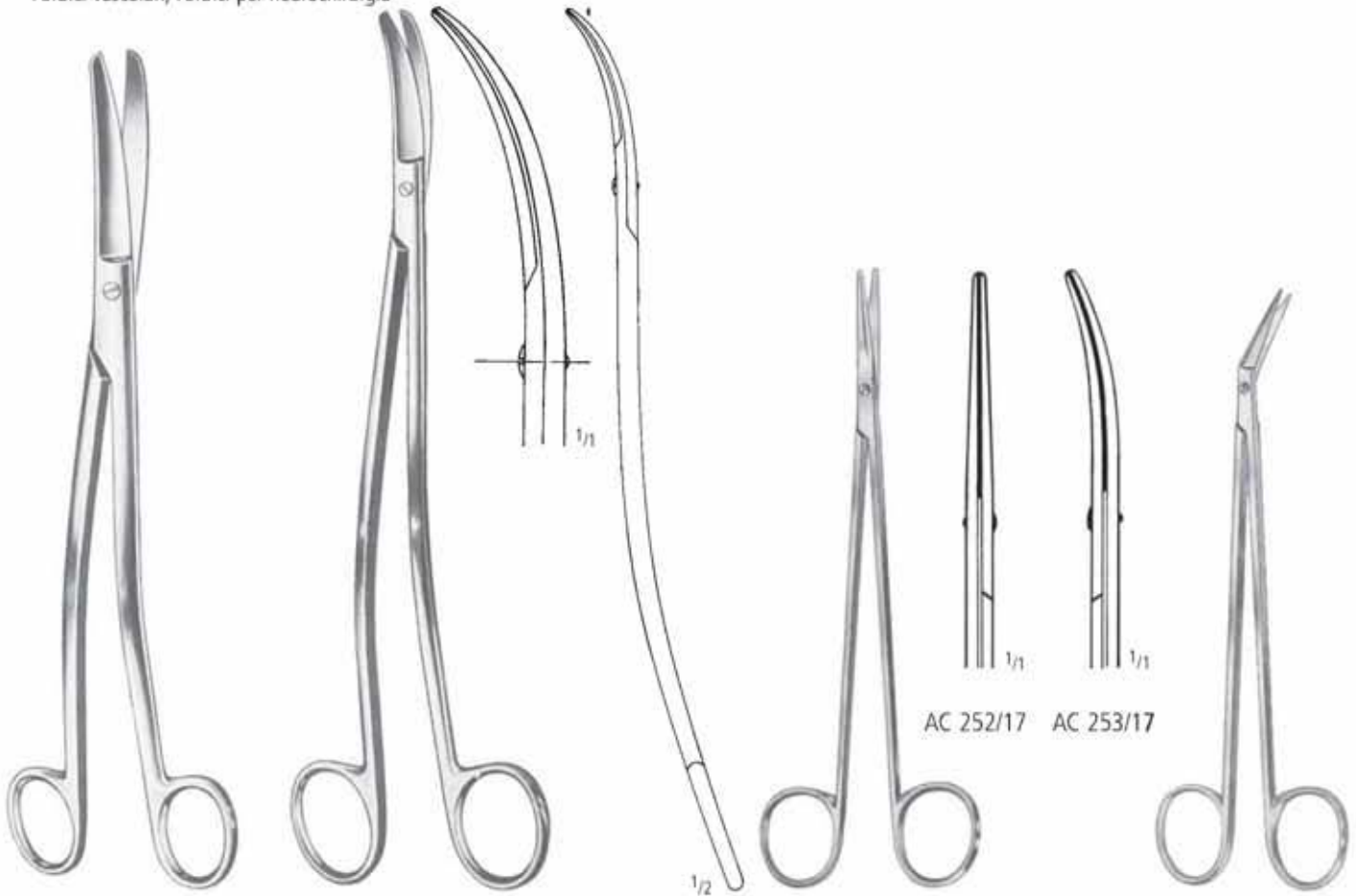

**KLINKENBERGH-LOTH**  
 AC 250/23  
 23,0 cm/9"

**SATINSKY**  
 AC 251/24  
 24,5 cm/9<sup>3</sup>/<sub>4</sub>"

**LINCOLN**  
 17,0 cm/6<sup>3</sup>/<sub>4</sub>"

**FULTON**  
 AC 255/17  
 17,0 cm/6<sup>3</sup>/<sub>4</sub>"

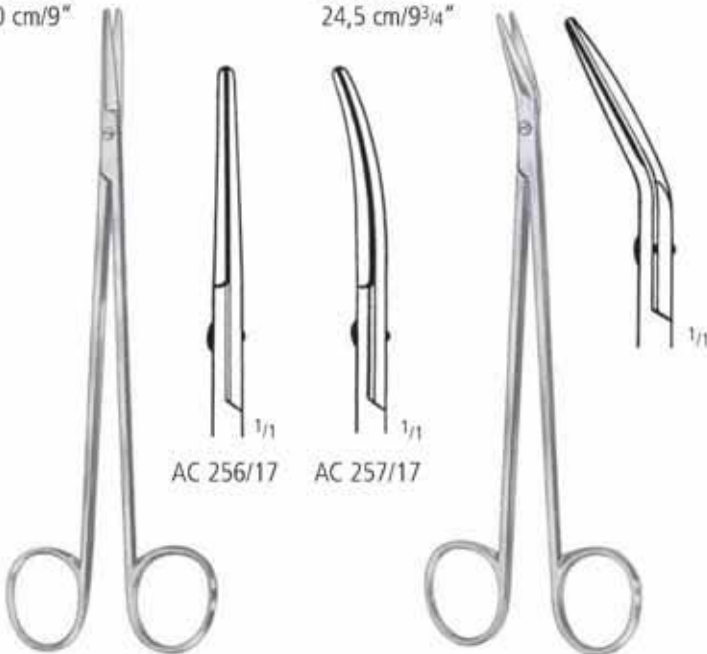

AC 256/17

AC 257/17



**CHURCH**  
 17,0 cm/6<sup>3</sup>/<sub>4</sub>"

**CLASSON**  
 AC 258/17  
 17,0 cm/6<sup>3</sup>/<sub>4</sub>"

**OLIVECRONA**  
 AC 259/23  
 23,0 cm/9"

**AC** SCHEREN SCISSORS TIJERAS CISEAUX FORBICI

Knorpel-, Lungenlappen-, Darm- und Anatomiescheren  
 Cartilage-, Lobectomy-, Enterotomy- and Dissecting Scissors  
 Tijeras para cartilago, lobectomia, enterótomos y disección  
 Ciseaux pour le cartilage, à lobectomie, à épisiotomie et à préparation  
 Forbici per cartilagini, lobectomia, episiotomia e anatomia

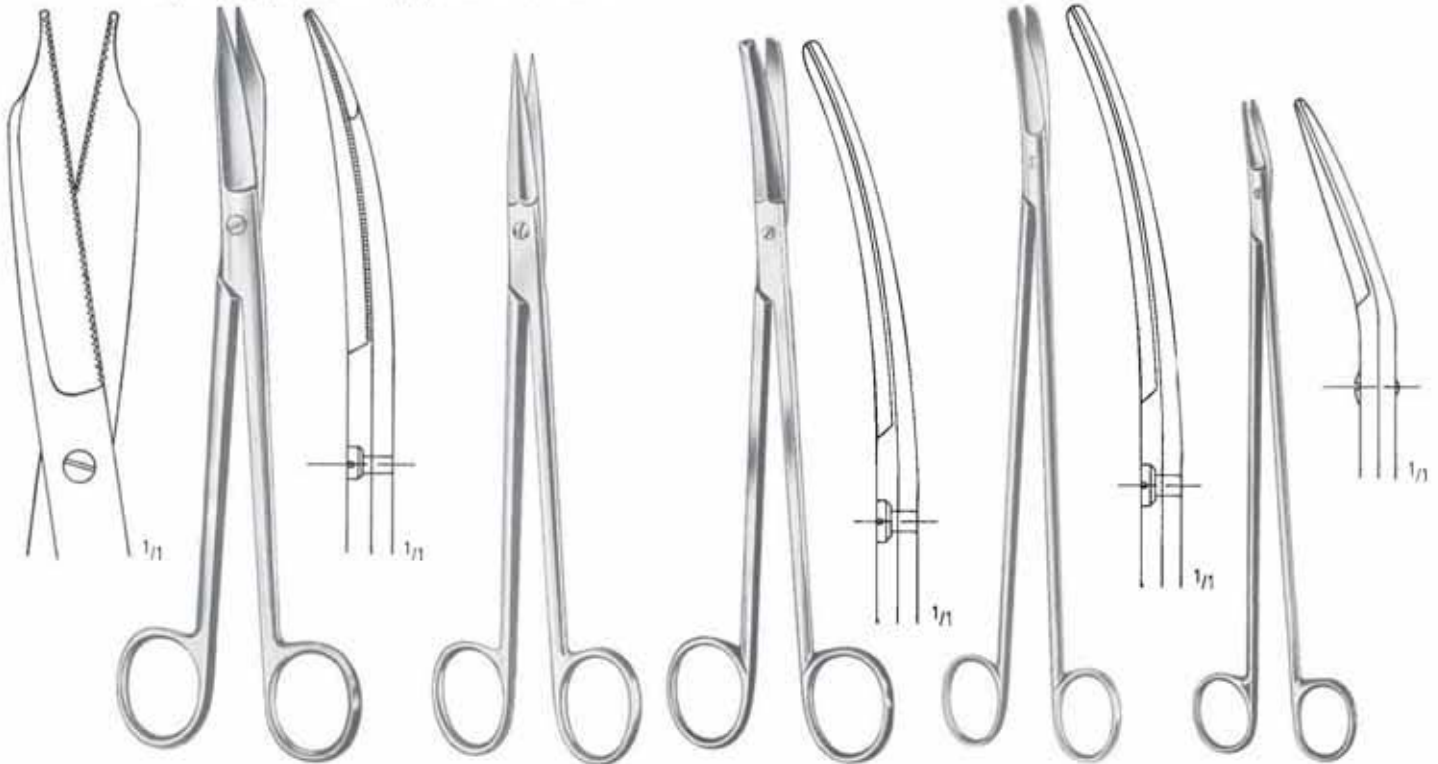

**MARTIN-CARTILAGE**  
 AC 275/20  
 20,0 cm/8"

**MC INDOE**  
 AC 276/19  
 19,0 cm/7½"

**POTTS-SMITH**  
 AC 277/19  
 19,0 cm/7½"

**CRAFOORD**  
 AC 280/30  
 30,0 cm/12"

**FINOCHIETTO**  
 AC 281/27  
 27,0 cm/10¾"



AC 285/21  
 21,0 cm/8¼"

AC 286/21  
 21,0 cm/8¼"

AC 287/21  
 21,0 cm/8¼"

AC 290/11 11,0 cm/4¼"  
 AC 290/13 13,0 cm/5"

AC 291/11  
 AC 291/13

SCHEREN SCISSORS TIJERAS CISEAUX FORBICI

Tonsillen- und Nasenscheren, Kropfschere  
 Tonsil and Nasal Scissors, Goitre Enucleation Scissors  
 Tijeras para amígdalas, Tijeras nasales, Tijeras para bocio  
 Ciseaux pour les amygdales, Ciseaux nasaux, Ciseaux à goitre  
 Forbici per tonsille, Forbici nasali, Forbici per gozzo



**PRINCE**  
 AC 301/17  
 17,5 cm/7"

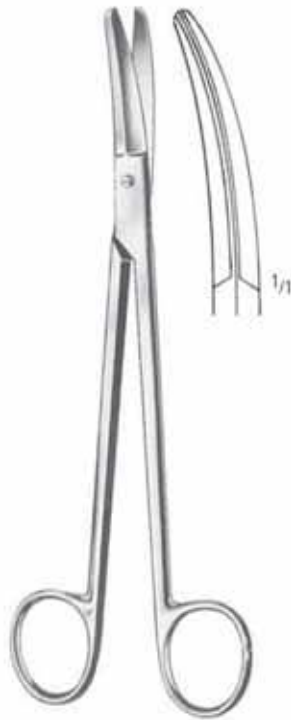

**BÖTTCHER**  
 AC 302/18  
 18,0 cm/7"



**GOOD**  
 AC 303/19  
 19,0 cm/7 1/2"



gezahnt  
 saw edge  
 dentadas  
 dentelés  
 dentata

**GOOD-SCHWECKENDICK**  
 AC 304/19  
 19,0 cm/7 1/2"



**SCHOEMAKER**  
 AC 305/15  
 15,0 cm/6"

AC 306/22  
 gerade  
 straight  
 rectas  
 droits  
 rette

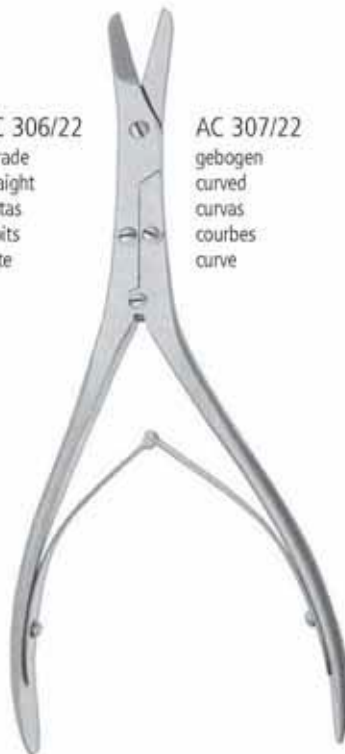

AC 307/22  
 gebogen  
 curved  
 curvas  
 courbes  
 curve

**CAPLAN**  
 22,0 cm/9"



**FOMON**  
 AC 309/13  
 13,5 cm/5 1/4"



**FOMON**  
 AC 310/13  
 13,5 cm/5 1/4"

AA  
 AB  
 AC  
 AD  
 AE  
 AF  
 AG  
 AH  
 AI  
 AJ  
 AK  
 AL  
 AM  
 AN  
 AO  
 AP  
 AQ  
 AR  
 AS  
 AT  
 AU  
 AV  
 AW  
 AX  
 AY  
 AZ

Nasenscheren  
Nasal Scissors  
Tijeras nasales  
Ciseaux nasaux  
Forbici nasale

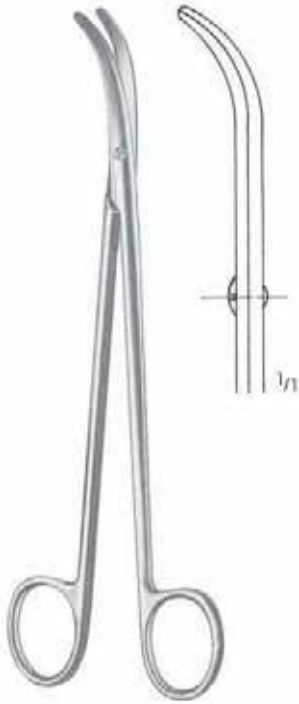

**HALLE**  
AC 313/19  
19,0 cm/7 1/2"

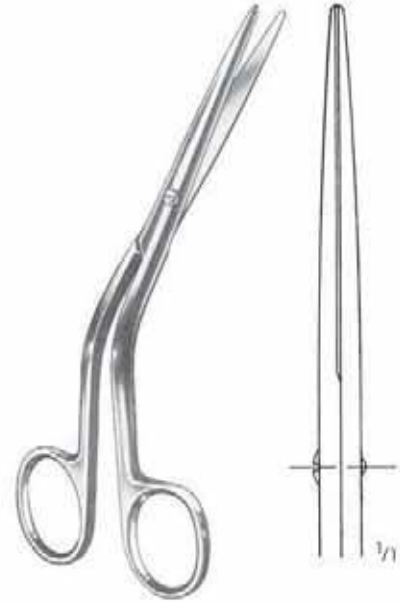

**COTTLE**  
AC 315/16  
16,0 cm/6 1/4"



**HEYMANN**  
AC 317/18  
18,0 cm/7"



**HEYMANN**  
AC 318/19  
19,5 cm/7 3/4"

SCHEREN SCISSORS TIJERAS CISEAUX FORBICI

Episiotomie- und Nabelschnurscheren  
 Episiotomy and Umbilical Scissors  
 Tijeras para episiotomia, Tijeras umbilicales  
 Ciseaux à épisiotomie et pour le cordon ombilical  
 Forbici per episiotomia, Forbici ombelicali



**BRAUN-STADLER**  
 AC 351/14  
 14,0 cm/5 1/2"



**BRAUN-STADLER**  
 20,0 cm/8" AC 351/20  
 22,0 cm/8 3/4" AC 351/22



**WALDMANN**  
 AC 353/18  
 18,0 cm/7"



AC 354/20  
 20,0 cm/8"



**MOD. USA**  
 AC 360/10  
 10,5 cm/4 1/4"



**SCHUMACHER**  
 AC 362/16  
 16,0 cm/6 1/4"



**BUSCH**  
 13,0 cm/5" AC 365/13  
 16,0 cm/6 1/4" AC 365/16

AA  
 AB  
 AC  
 AD  
 AE  
 AF  
 AG  
 AH  
 AI  
 AJ  
 AK  
 AL  
 AM  
 AN  
 AO  
 AP  
 AQ  
 AR  
 AS  
 AT  
 AU  
 AV  
 AW  
 AX  
 AY  
 AZ



Feine chirurgische Scheren  
 Fine Operating Scissors  
 Tijeras finas para cirugía  
 Ciseaux fins à chirurgie  
 Forbici fini per chirurgia



**WAGNER**  
 12,0 cm/4<sup>3</sup>/<sub>4</sub>"

gerade  
 straight  
 rectas  
 droits  
 rette



Fig. 1  
 AC 404/01



Fig. 2  
 AC 404/02



Fig. 3  
 AC 404/03

gebogen  
 curved  
 curvas  
 courbes  
 curve



Fig. 1  
 AC 405/01



Fig. 2  
 AC 405/02



Fig. 3  
 AC 405/03



AC 408/11  
 11,0 cm/4<sup>1</sup>/<sub>3</sub>"



AC 409/11  
 11,0 cm/4<sup>1</sup>/<sub>3</sub>"



SCHEREN SCISSORS TIJERAS CISEAUX FORBICI

Feine Scheren  
Fine Scissors  
Tijeras finas  
Ciseaux fins  
Forbici fini

AA  
AB  
AC  
AD  
AE  
AF  
AK  
AL  
AM  
AO  
AP  
AR  
KA  
KD  
KY

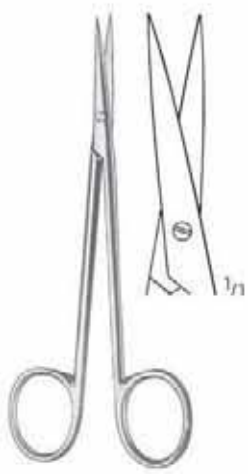

AC 410/11  
11,5 cm/4 1/2"



AC 411/11  
11,5 cm/4 1/2"

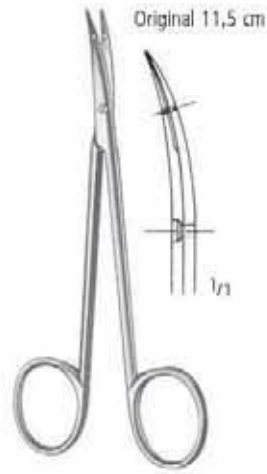

**LITTLER**  
AC 412/11 11,5 cm/4 1/2"  
AC 412/14 14,0 cm/5 1/2"

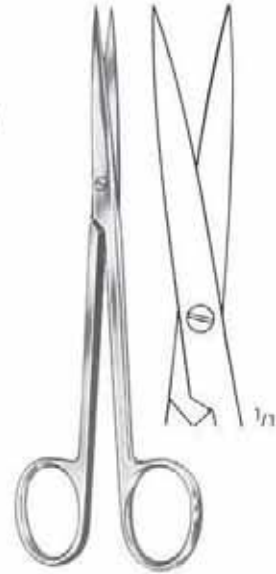

**BROPHY (SULLIVAN)**  
AC 414/14  
14,5 cm/5 3/4"

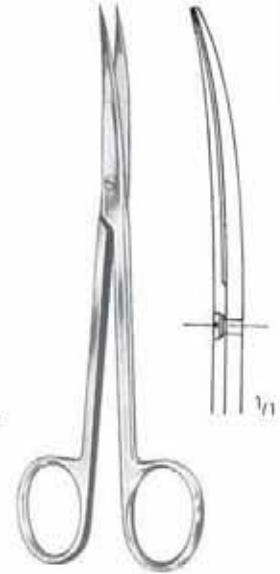

AC 415/14  
14,5 cm/5 3/4"

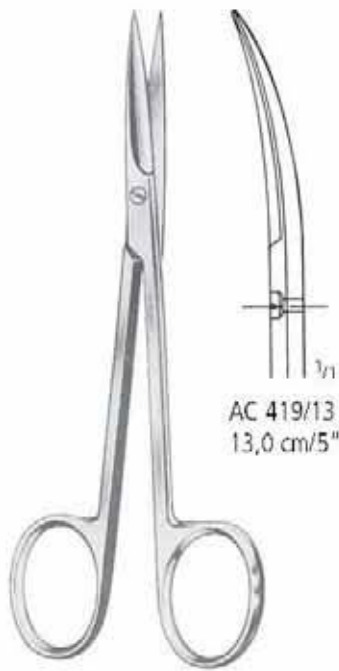

AC 418/13  
13,0 cm/5"

AC 419/13  
13,0 cm/5"



AC 422/10  
AC 422/11



10,5 cm/4 1/4"  
11,5 cm/4 1/2"

AC 423/10  
AC 423/11



AC 424/11  
11,5 cm/4 1/2"

**AC** SCHEREN SCISSORS TIJERAS CISEAUX FORBICI

Feine Scheren  
Fine Scissors  
Tijeras finas  
Ciseaux fins  
Forbici fini

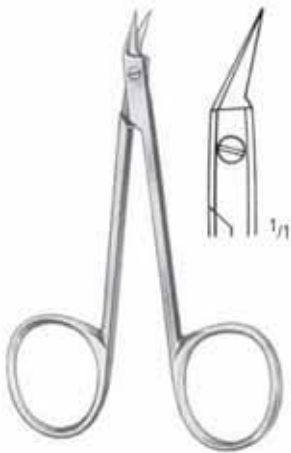

**O'BRIEN**  
AC 427/09  
9,0 cm/3 1/2"



**WALTON**  
AC 429/10  
10,0 cm/4"

sehr fein  
extra delicate  
muy finas  
très fin  
molto sottile



AC 430/08  
8,0 cm/3"

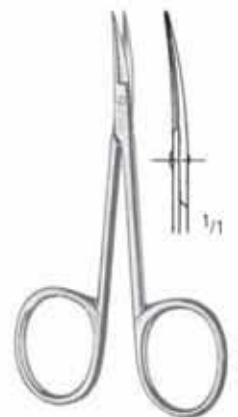

**MOD. BONN**  
AC 431/08  
8,0 cm/3"



**LANDOLT**  
AC 434/12  
12,5 cm/5"



**LANDOLT**  
AC 435/12  
12,5 cm/5"



**LANDOLT**  
AC 436/12  
12,5 cm/5"



**LANDOLT**  
AC 437/12  
12,5 cm/5"

SCHEREN SCISSORS TIJERAS CISEAUX FORBICI

Augenscheren  
Eye Scissors  
Tijeras oculares  
Ciseaux oculaires  
Forbici oftalmologici

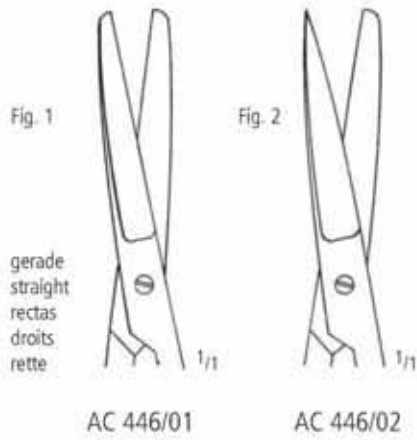

11,5 cm/4 1/2"

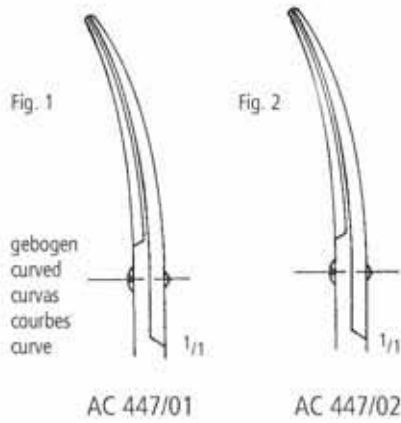

AC 448/11  
11,5 cm/4 1/2"

AC 449/11  
11,5 cm/4 1/2"

Irisscheren  
Iris Scissors  
Tijeras para iridectomia  
Ciseaux à iridectomie  
Forbici per iridectomia

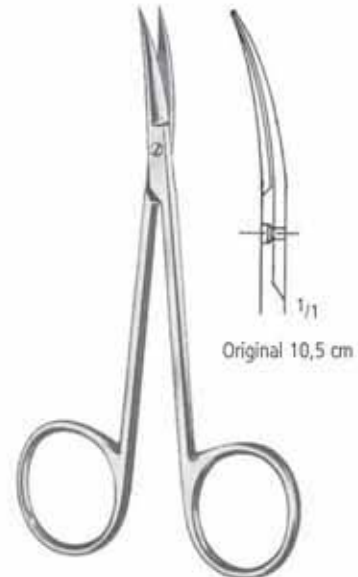
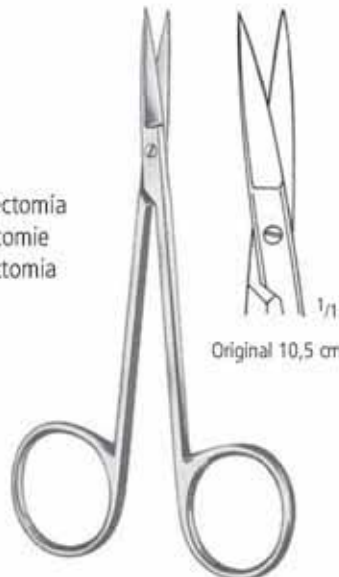

9,0 cm/3 1/2"	AC 450/09	AC 451/09
10,5 cm/4 1/4"	AC 450/10	AC 451/10
11,5 cm/4 1/2"	AC 450/11*	AC 451/11*

AA  
AB  
AC  
AD  
AE  
AF  
AK  
AL  
AM  
AQ  
AP  
AR  
KA  
KD  
KU  
KY

**AC** SCHEREN SCISSORS TIJERAS CISEAUX FORBICI

Augenscheren  
Eye Scissors  
Tijeras oculares  
Ciseaux oculaires  
Forbici oftalmologici

mit großen Ringen  
with large bows  
con anillos grandes  
avec grands anneaux  
con anelli grandi

Strabismusscheren  
Strabismus Scissors  
Tijeras para estrabismo  
Ciseaux à strabisme  
Forbici per strabismo

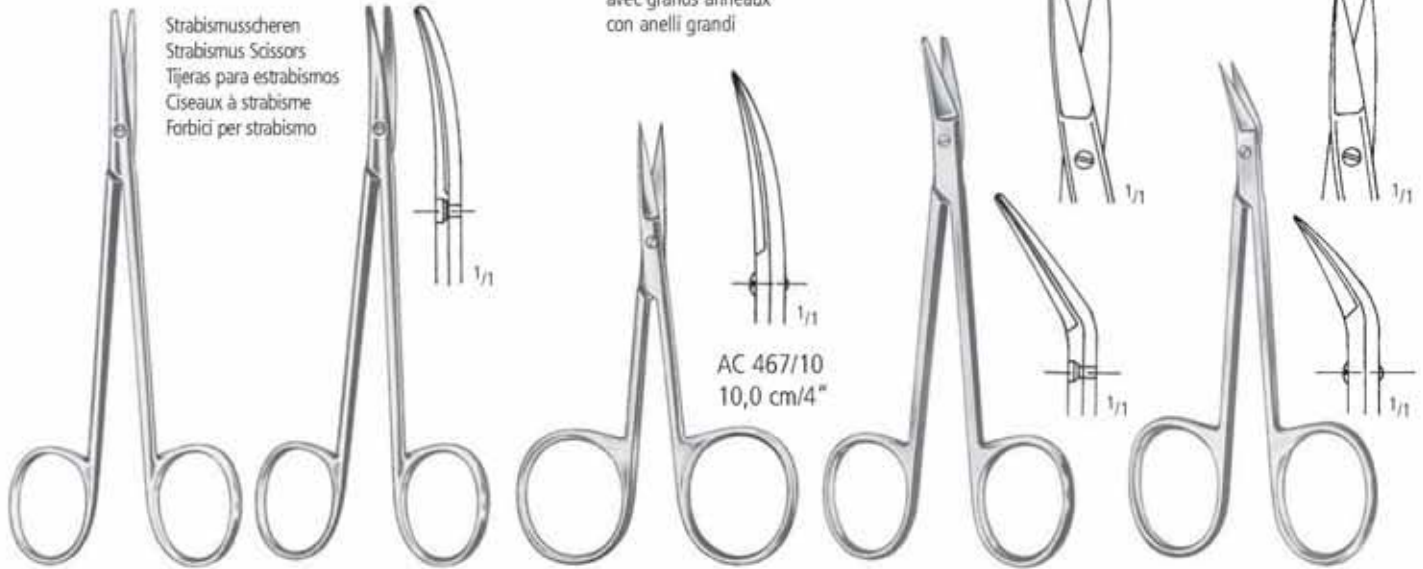

AC 460/11\*  
11,5 cm/4 1/2"

AC 461/11\*  
11,5 cm/4 1/2"

AC 466/10  
10,0 cm/4"

**GRAEFE**  
AC 469/10  
10,5 cm/4 1/4"

**WILMER**  
AC 471/10  
10,0 cm/4"

Sehnerscheren  
Tenotomy Scissors  
Tijeras para tenotomía  
Ciseaux à ténatomie  
Forbici per tenotomia

Original 11,5 cm

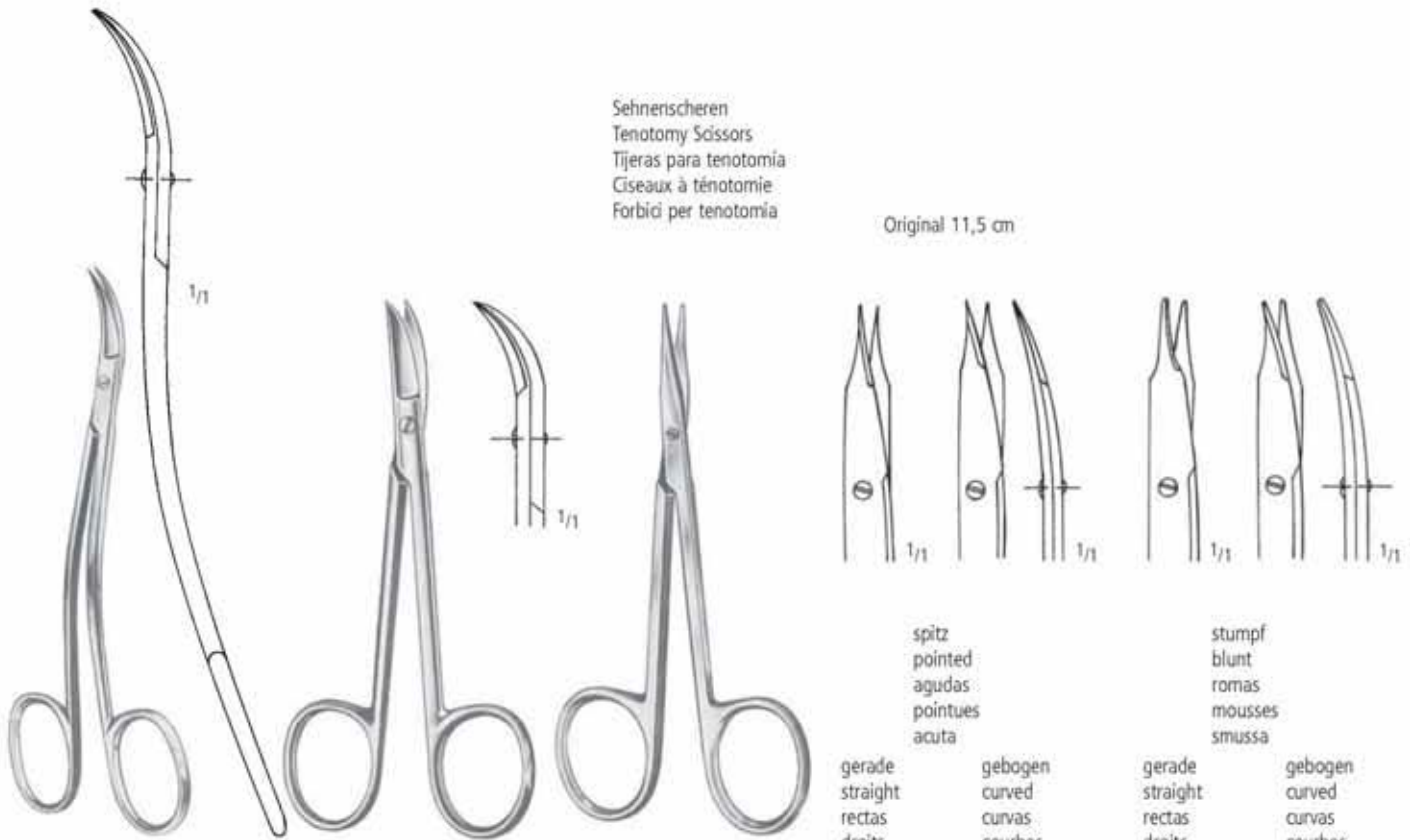

spitz  
pointed  
agudas  
pointues  
acuta

stumpf  
blunt  
romas  
mousses  
smussa

gerade  
straight  
rectas  
droits  
rette

gebogen  
curved  
curvas  
courbes  
curve

gerade  
straight  
rectas  
droits  
rette

gebogen  
curved  
curvas  
courbes  
curve

**LA GRANGE**  
AC 472/11  
11,5 cm/4 1/2"

**CHADWICK**  
AC 473/11  
11,0 cm/4 1/3"

**STEVENS**  
10,5 cm/4 1/4"  
11,5 cm/4 1/2"

AC 474/10  
AC 474/11

AC 475/10  
AC 475/11

AC 476/10  
AC 476/11\*

AC 477/10  
AC 477/11\*

SCHEREN SCISSORS TIJERAS CISEAUX FORBICI

Augenscheren  
Eye Scissors  
Tijeras oculares  
Ciseaux oculaires  
Forbici oftalmologici



gerade  
straight  
rectas  
droits  
rette

gebogen  
curved  
curvas  
courbes  
curve

**RIBBON**  
AC 488/10 AC 489/10  
10,0 cm/4"



gerade  
straight  
rectas  
droits  
rette

gebogen  
curved  
curvas  
courbes  
curve

**RIBBON**  
AC 490/10 AC 491/10  
10,0 cm/4"



gerade  
straight  
rectas  
droits  
rette

gebogen  
curved  
curvas  
courbes  
curve

**RIBBON**  
AC 492/10 AC 493/10  
10,0 cm/4"

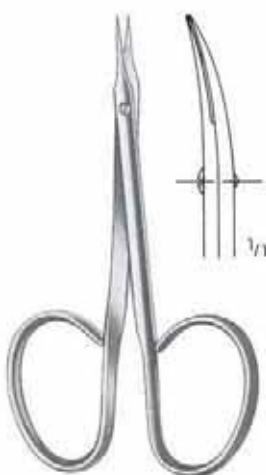

gerade  
straight  
rectas  
droits  
rette

gebogen  
curved  
curvas  
courbes  
curve

**RIBBON**  
AC 494/09 AC 495/09  
9,5 cm/3<sup>3</sup>/<sub>4</sub>"

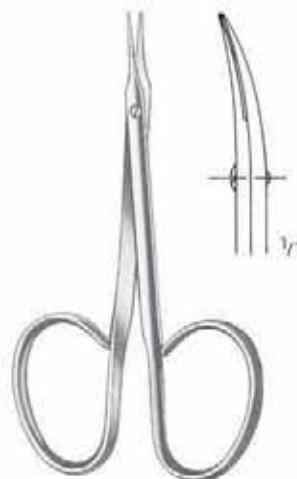

gerade  
straight  
rectas  
droits  
rette

gebogen  
curved  
curvas  
courbes  
curve

**RIBBON**  
AC 496/09 AC 497/09  
9,5 cm/3<sup>3</sup>/<sub>4</sub>"

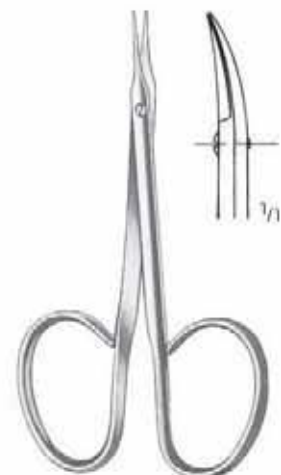

gerade  
straight  
rectas  
droits  
rette

gebogen  
curved  
curvas  
courbes  
curve

**RIBBON**  
AC 498/09 AC 499/09  
9,5 cm/3<sup>3</sup>/<sub>4</sub>"

AA  
AB  
AC  
AD  
AE  
AF  
AK  
AL  
AM  
AO  
AP  
AR  
KA  
KD  
KU  
KY



Ligaturscheren  
Ligature Scissors  
Tijeras para ligaduras  
Ciseaux à ligatures  
Forbici per legatura



**SPENCER**

9,0 cm/3<sup>1</sup>/<sub>2</sub>" AC 500/09  
10,5 cm/4<sup>1</sup>/<sub>4</sub>" AC 500/10  
12,5 cm/5" AC 500/13



**SPENCER-DELICATE**

AC 501/11  
11,0 cm/4<sup>1</sup>/<sub>3</sub>"



**LITTAUER**

AC 502/14  
14,0 cm/5<sup>1</sup>/<sub>2</sub>"



AC 503/16  
16,0 cm/6<sup>1</sup>/<sub>4</sub>"



**EISELSBERG**  
AC 504/12  
11,0 cm/4<sup>1</sup>/<sub>3</sub>"



**SCHOEMAKER-LOTH**  
AC 505/12  
12,5 cm/5"



AC 506/11  
11,5 cm/4<sup>1</sup>/<sub>2</sub>"



SCHEREN SCISSORS TIJERAS CISEAUX FORBICI

Ligaturscheren  
Ligature Scissors  
Tijeras para ligaduras  
Ciseaux à ligatures  
Forbici per legatura

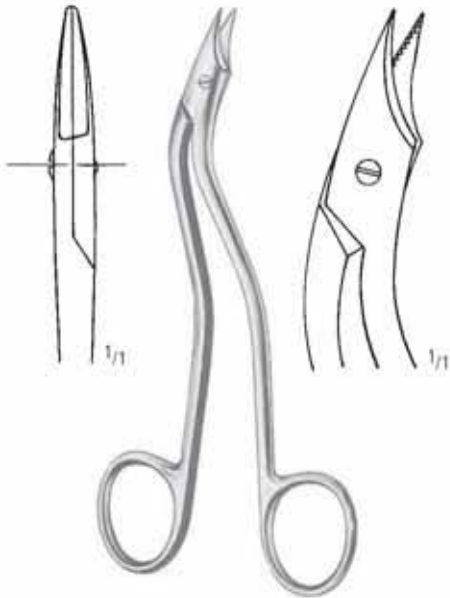

**HEATH**  
AC 507/15  
15,0 cm/6"



gezahnt  
saw edge  
dentadas  
dentelés  
dentata

AC 509/12  
12,0 cm/4<sup>3</sup>/<sub>4</sub>"



**SHORTBENT**  
AC 513/09  
9,0 cm/3<sup>1</sup>/<sub>2</sub>"



**NORTHBENT**  
AC 514/12  
12,5 cm/5"



**BUCK**  
14,5 cm/5<sup>3</sup>/<sub>4</sub>" AC 516/14  
18,0 cm/7" AC 516/18

AA  
AB  
AC  
AD  
AE  
AF  
AK  
AL  
AM  
AQ  
AP  
AR  
KA  
KD  
KU  
KY

**AC** SCHEREN SCISSORS TIJERAS CISEAUX FORBICI

Draht- und Kronenscheren  
 Wire Cutting and Crown Scissors  
 Cizallas para cortar alambre, Tijeras para coronas  
 Cisailles pour fils, Ciseaux à couronnes  
 Forbici per filo metallico e per corone



**HARVEY**  
 AC 520/12  
 12,5 cm/5"

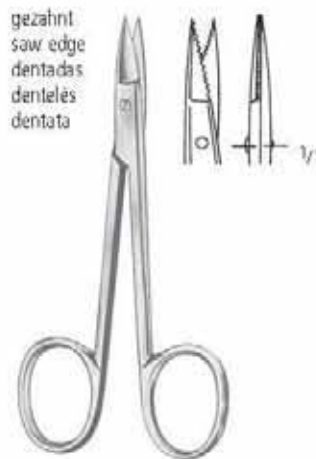

**SCHUKNECHT**  
 AC 521/10  
 10,0 cm/4"



AC 522/11  
 11,0 cm/4 1/8"



**UNIVERSAL**  
 AC 524/12  
 12,0 cm/4 3/4"



**SMITH**  
 AC 525/17  
 17,5 cm/7"



**BEEBEE**  
 10,5 cm/4 1/4"  
 gerade - straight - rectas - droits - rette

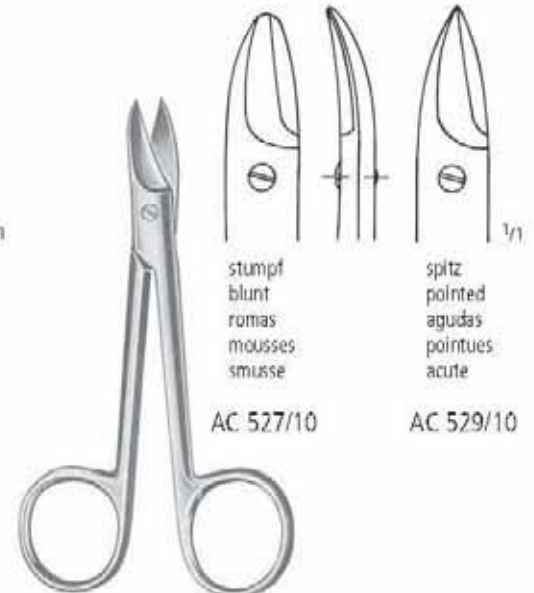

**BEEBEE**  
 10,5 cm/4 1/4"  
 gebogen - curved - curvas - courbes - curve

SCHEREN SCISSORS TIJERAS CISEAUX FORBICI

Kronenscheren  
 Crown Scissors  
 Tijeras para coronas  
 Ciseaux à couronnes  
 Forbici per corone

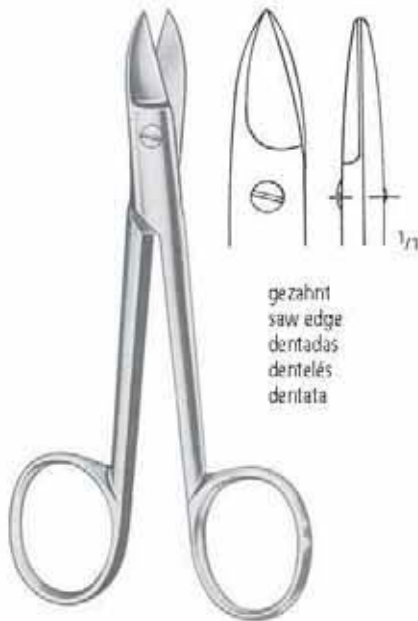

gezahnt  
 saw edge  
 dentadas  
 dentelés  
 dentata

**BEEBEE**  
 AC 530/12  
 12,0 cm/4<sup>3</sup>/<sub>4</sub>"

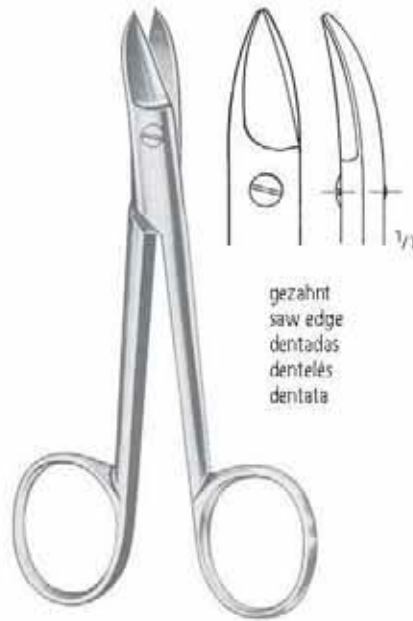

gezahnt  
 saw edge  
 dentadas  
 dentelés  
 dentata

**BEEBEE**  
 AC 531/12  
 12,0 cm/4<sup>3</sup>/<sub>4</sub>"



AC 535/10  
 10,5 cm/4<sup>1</sup>/<sub>4</sub>"



AC 536/09  
 9,0 cm/3<sup>1</sup>/<sub>2</sub>"



AC 537/09  
 9,0 cm/3<sup>1</sup>/<sub>2</sub>"



AC 538/11  
 11,0 cm/4<sup>1</sup>/<sub>3</sub>"



AC 539/11  
 11,0 cm/4<sup>1</sup>/<sub>3</sub>"

AA  
 AB  
 AC  
 AD  
 AE  
 AF  
 AK  
 AL  
 AM  
 AO  
 AP  
 AR  
 KA  
 KD  
 KU  
 KY

Verband- und Kleiderscheren  
 Bandage and Clothing Scissors  
 Tijeras para vendajes y vestidos  
 Ciseaux pour pansements  
 Forbici per bendaggi



AC 551/14  
 14,5 cm/5<sup>3</sup>/<sub>4</sub>"

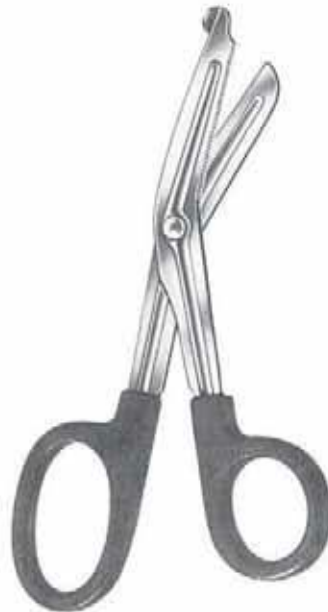

AC 551/16  
 16,0 cm/6<sup>1</sup>/<sub>4</sub>"



143° C/290° F  
 autoclavable

**UNIVERSAL**  
 AC 551/18  
 18,0 cm/7"



**BERGMANN**  
 AC 553/23  
 23,0 cm/9"



**LANGE**  
 AC 554/18  
 18,0 cm/7"



gezahnt  
 saw edge  
 dentadas  
 dentelés  
 dentata

AC 555/17  
 17,0 cm/6<sup>3</sup>/<sub>4</sub>"

SCHEREN SCISSORS TIJERAS CISEAUX FORBICI

Verband- und Kleiderscheren  
Bandage and Clothing Scissors  
Tijeras para vendajes y vestidos  
Ciseaux pour pansements  
Forbici per bendaggi



**SMITH (Mod. USA)**  
18,0 cm/7"  
20,0 cm/8"  
23,0 cm/9" AC 560/18  
AC 560/20  
AC 560/23



**LORENZ**  
AC 561/23  
23,0 cm/9"



**KNOWLES**  
AC 563/14  
14,0 cm/5½"



10r Finger  
for fingers  
para dedos  
pour doigts  
per dita

**KNOWLES**  
AC 564/14  
14,0 cm/5½"



**LISTER**  
18,5 cm/7¼"  
21,0 cm/8¼" AC 565/18  
AC 565/21



gezahnt  
saw edge  
dentadas  
dentelés  
dentata

**LISTER-EXCENTRIC**  
16,0 cm/6¼"  
19,0 cm/7½" AC 566/16  
AC 566/19

AA  
AB  
AC  
AD  
AE  
AF  
AK  
AL  
AM  
AO  
AP  
AR  
KA  
KD  
KY



**AC** SCHEREN SCISSORS TIJERAS CISEAUX FORBICI

Verbandscheren, Gipsscheren  
 Bandage Scissors, Plaster-of-Paris Shears  
 Tijeras para vendajes, Cizallas para vendajes enyesados  
 Ciseaux pour pansements, Cisailles pour appareils plâtrés  
 forbici per bendaggi e per apparecchi gessati



9,0 cm/3 1/2"	AC 567/09
11,0 cm/4 1/3"	AC 567/11
14,0 cm/5 1/2"	AC 567/14
15,5 cm/6"	AC 567/15
18,0 cm/7"	AC 567/18
20,0 cm/8"	AC 567/20

**LISTER**



20,0 cm/8"	AC 569/20
22,0 cm/8 3/4"	AC 569/22

**ESMARCH**



**SEUTIN**  
 AC 571/23  
 23,0 cm/9"



gezahnt  
 saw edge  
 dentadas  
 dentelés  
 dentata

AC 573/20  
 20,0 cm/8"



gezahnt  
 saw edge  
 dentadas  
 dentelés  
 dentata

AC 579/24

glatt  
 smooth  
 liso  
 lisse  
 liscio

AC 580/24

**BRUNS**  
 24,0 cm/9 1/2"

SCHEREN SCISSORS TIJERAS CISEAUX FORBICI

Nagelscheren, Hautscheren, Nagelspaltscheren  
 Nail Scissors, Cuticle Scissors, Nail Splitting Scissors  
 Tijeras para uñas, Tijeras cuticulares, Tijeras para uñas encarnadas  
 Ciseaux à ongles, Ciseaux à envies, Ciseaux pour ongles incarnés  
 Forbici per unghie, Forbici per pelle, Forbici per unghie incarnate

AA  
AB  
AC  
AD  
AE  
AF  
AK  
AL  
AM  
AO  
AP  
AR  
KA  
KD  
KU  
KY



9,0 cm/3 1/2"  
10,5 cm/4 1/4" AC 608/09  
AC 608/10

AC 609/09  
AC 609/10

AC 610/09  
AC 610/10

AC 611/09  
AC 611/10

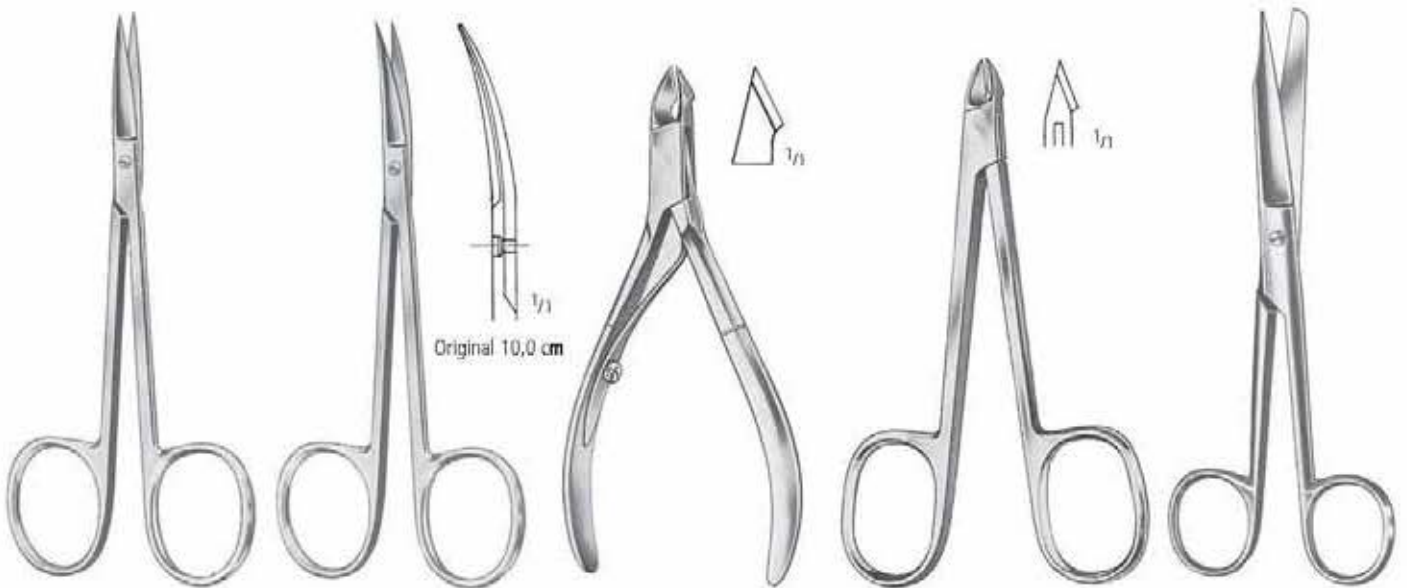

AC 612/10 10,0 cm/4"  
AC 612/11 11,0 cm/4 1/3"

AC 613/10  
AC 613/11

AC 624/11  
10,5 cm/4 1/4"

AC 626/11  
10,5 cm/4 1/4"

**KÖNIG**  
AC 628/13 13,0 cm/5"  
AC 628/15 15,0 cm/6"

**AC** SCHEREN SCISSORS TIJERAS CISEAUX FORBICI

Zahnfleischscheren  
Gum Scissors  
Tijeras para encias  
Ciseaux à gencives  
Forbici per gengiva

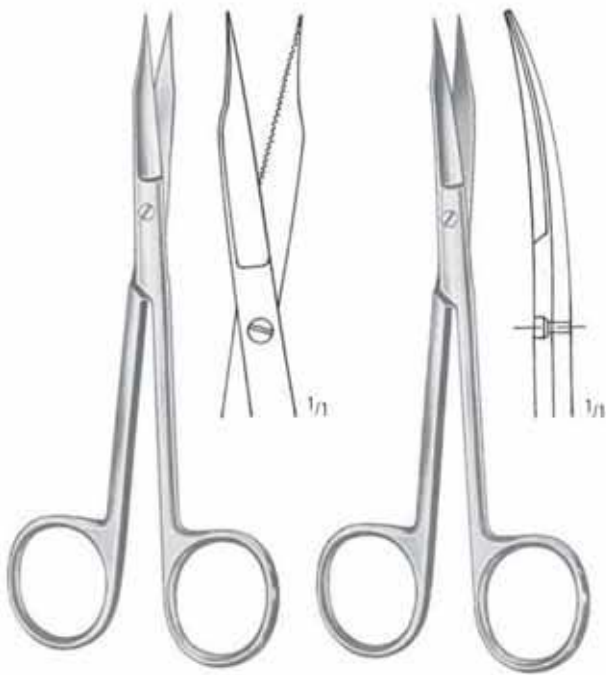

**GOLDMAN-FOX**

AC 630/13  
13,0 cm/5"

AC 631/13  
13,0 cm/5"

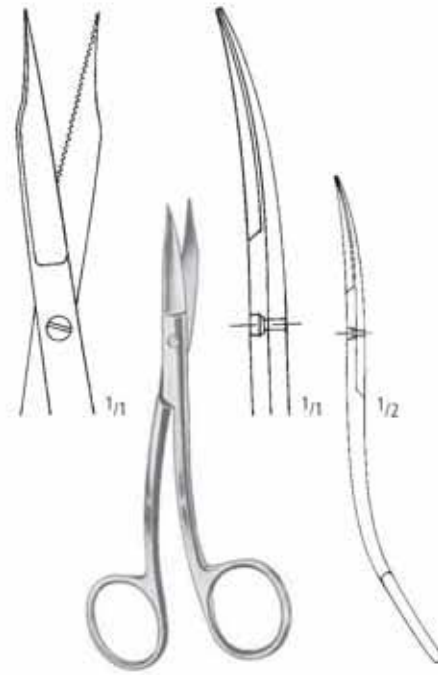

**GOLDMAN-FOX (SPEZIAL)**

AC 635/13  
13,0 cm/5"

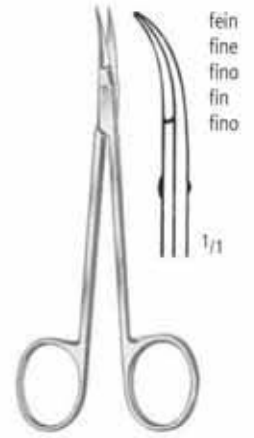

AC 637/11  
11,5 cm/4 1/2"

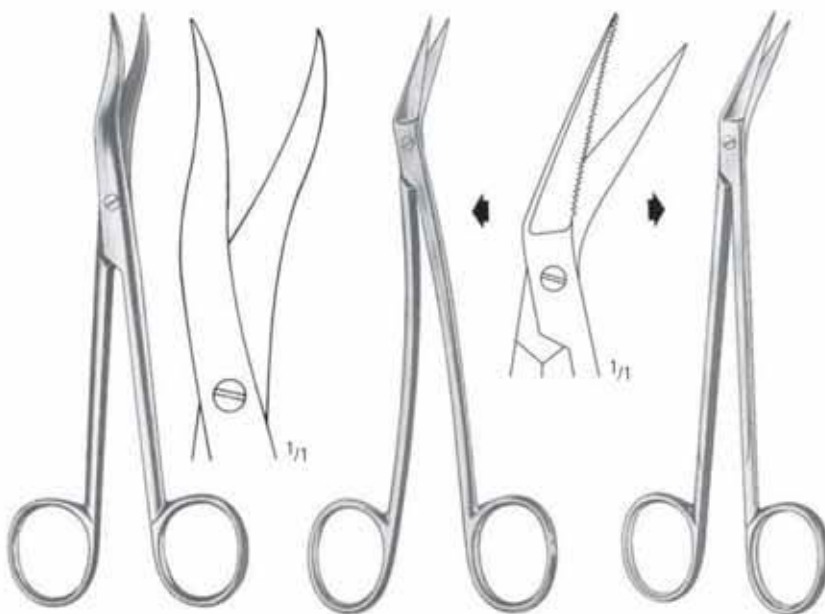

AC 639/16  
16,0 cm/6 1/4"

**LOCKLIN**  
AC 640/16  
16,5 cm/6 1/2"

**LOCKLIN**  
AC 641/16  
16,5 cm/6 1/2"

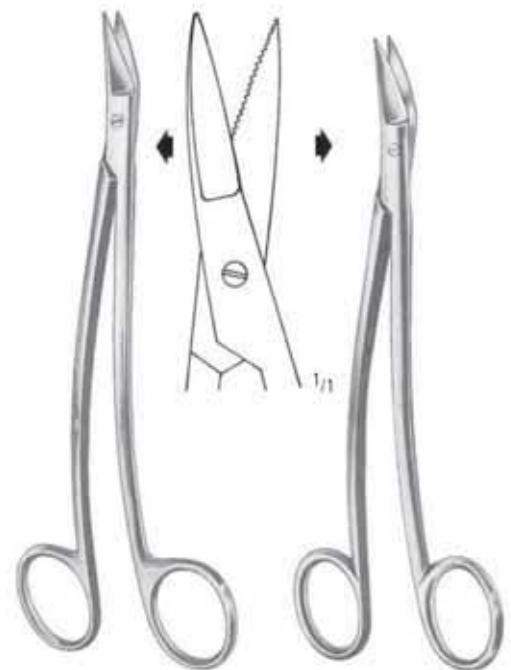

**DEAN-DELICATE**  
AC 642/17  
17,0 cm/6 3/4"

**DEAN**  
AC 643/17  
17,0 cm/6 3/4"

SCHEREN SCISSORS TIJERAS CISEAUX FORBICI

Zahnfleischscheren  
Gum Scissors  
Tijeras para encias  
Ciseaux à gencives  
Forbici per gengiva

AA  
AB  
AC  
AD  
AE  
AF  
AK  
AL  
AM  
AO  
AP  
AR  
KA  
KD  
KU  
KY



**QUINBY**

AC 646/12  
12,0 cm/4<sup>3</sup>/<sub>4</sub>"

AC 647/12  
12,0 cm/4<sup>3</sup>/<sub>4</sub>"



gezahnt  
saw edge  
dentadas  
denteles  
dentata

**STANDARD**

AC 648/11  
11,0 cm/4<sup>1</sup>/<sub>3</sub>"

AC 649/11  
11,0 cm/4<sup>1</sup>/<sub>3</sub>"

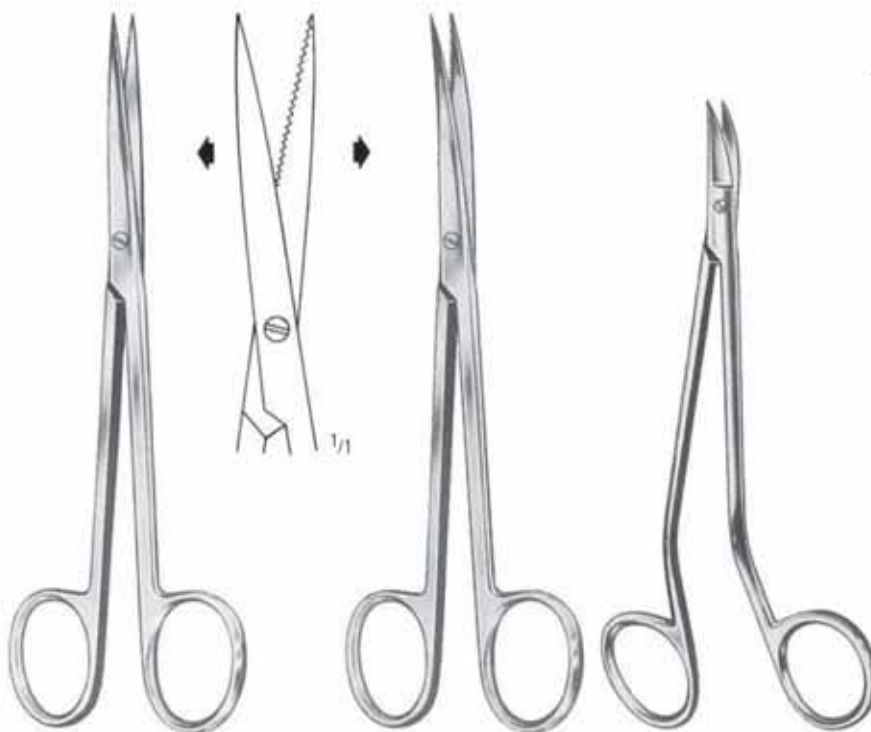

**SULLIVAN**

AC 650/14  
14,5 cm/5<sup>3</sup>/<sub>4</sub>"

AC 651/14  
14,5 cm/5<sup>3</sup>/<sub>4</sub>"

**NEUMANN**

AC 653/12  
12,5 cm/5"

Weitere Zahnfleischscheren, siehe Seiten  
108, 110, 112, 124, 127, 128, 161, 162

Other Gum Scissors see pages  
108, 110, 112, 124, 127, 128, 161, 162

Tijeras para encias similares véanse páginas  
108, 110, 112, 124, 127, 128, 161, 162

Ciseaux à gencives ultérieure voir pages  
108, 110, 112, 124, 127, 128, 161, 162

Forbici per gengiva ulteriori vedere pagine  
108, 110, 112, 124, 127, 128, 161, 162



**AC** SCHEREN SCISSORS TIJERAS CISEAUX FORBICI

Iridektomiescheren  
Iris Scissors  
Pinzas-tijeras para iridectomía  
Ciseaux à iridectomie  
Forbici per iridectomia



Fig. 1

Fig. 2

Fig. 3

**NOYES**

12,0 cm/4<sup>3</sup>/<sub>4</sub>"



Fig. 1 AC 751/12

Fig. 2 AC 753/12

Fig. 3 AC 755/12



AC 760/11



AC 762/11



AC 764/11



**BARRAQUER**

5,5 cm/2<sup>1</sup>/<sub>4</sub>"

5 mm AC 768/05

7 mm AC 768/07

10 mm AC 768/10

**WECKER**

11,0 cm/4<sup>1</sup>/<sub>3</sub>"

Fig. 1 AC 750/12

Fig. 2 AC 752/12

Fig. 3 AC 754/12



AC 770/02



AC 770/03



AC 771/09



AC 772/09

**CASTROVIEJO**

AC 770/00  
9,0 cm/3<sup>1</sup>/<sub>2</sub>"



AC 773/10

spitz  
pointed  
agudas  
pointues  
acute

**CASTROVIEJO**

10,0 cm/4"

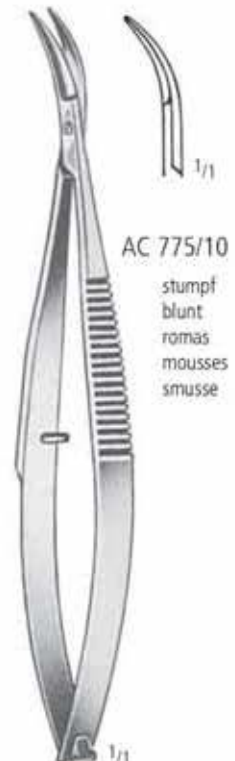

AC 775/10

stumpf  
blunt  
romas  
mousses  
smusse

**CASTROVIEJO**

10,0 cm/4"



SCHEREN SCISSORS TIJERAS CISEAUX FORBICI

Nachstarscheren  
 Secondary Cataract Scissors  
 Pinzas-tijeras para catarata secundaria  
 Pincès ciseaux pour le cataracte secondaire  
 Pinze-forbici per cataratta secundaria



gerade  
 straight  
 rectas  
 droits  
 rette

AC 776/01  
 8,5 cm/3 1/8"

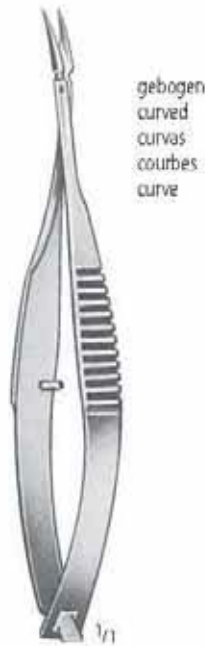

gebogen  
 curved  
 curvas  
 courbes  
 curve

AC 776/02  
 8,5 cm/3 1/8"

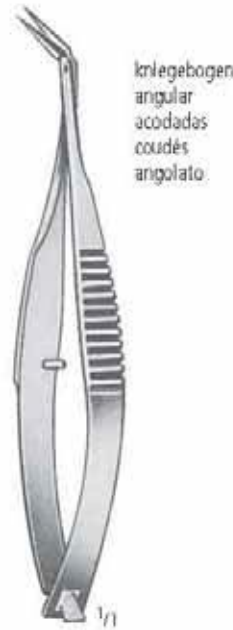

kniegebogen  
 angular  
 acodadas  
 coudés  
 angolato

AC 776/03  
 8,5 cm/3 1/8"



aufgewinkelt  
 angled on flat  
 acodadas hacia arriba  
 coudés vers le haut  
 angolato in alto

AC 776/04  
 8,5 cm/3 1/8"

VANNAS MOD. TÜBINGEN

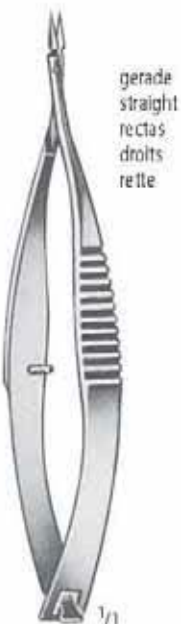

gerade  
 straight  
 rectas  
 droits  
 rette

VANNAS  
 AC 778/01  
 8,0 cm/3"



gebogen  
 curved  
 curvas  
 courbes  
 curve

VANNAS  
 AC 778/02  
 8,0 cm/3"



kniegebogen  
 angular  
 acodadas  
 coudés  
 angolato

VANNAS  
 AC 778/03  
 8,0 cm/3"

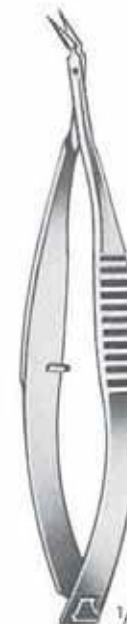

aufgewinkelt  
 angled on flat  
 acodadas hacia arriba  
 coudés vers le haut  
 angolato in alto

VANNAS  
 AC 778/04  
 8,0 cm/3"

AA  
 AB  
 AC  
 AD  
 AE  
 AF  
 AK  
 AL  
 AM  
 AO  
 AP  
 AR  
 KA  
 KD  
 KU  
 KY

**AC** SCHEREN SCISSORS TIJERAS CISEAUX FORBICI

Sehnenscheren, Kapsulotomiescheren  
 Tenotomy Scissors, Capsulotomy Scissors  
 Tijeras para tenotomía, Tijeras para capsulotomía  
 Ciseaux à ténatomie, Ciseaux pour capsulotomie  
 Forbici per tenotomia, Forbici per capsulotomia



**GILLS-WELSH**  
 8,5 cm/3 1/8"



AC 779/01



AC 779/02



AC 779/03

kniegebogen  
 angular  
 acodadas  
 coudés  
 angolato



AC 779/04

aufgewinkelt  
 angled on flat  
 acodadas hacia arriba  
 coudés vers le haut  
 angolato in alto



**WESTCOTT**  
 AC 780/11  
 11,0 cm/4 1/8"



**WESTCOTT**  
 AC 782/11  
 11,0 cm/4 1/8"

SCHEREN SCISSORS TIJERAS CISEAUX FORBICI

Hornhautscheren  
 Corneal Section Scissors  
 Pinzas-tijeras para córnea  
 Pincés ciseaux corneales  
 Forbici per cornea



**CASTROVIEJO**  
 AC 785/01  
 10,0 cm/4"



**CASTROVIEJO**  
 AC 785/02  
 10,0 cm/4"

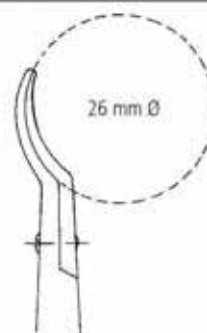

**CASTROVIEJO**  
 AC 786/01  
 11,0 cm/4 1/3"



**CASTROVIEJO**  
 AC 786/02  
 11,0 cm/4 1/3"



**TROUTMAN**  
 AC 788/01  
 10,0 cm/4"



**TROUTMAN**  
 AC 788/02  
 10,0 cm/4"

AA  
 AB  
 AC  
 AD  
 AE  
 AF  
 AK  
 AL  
 AM  
 AO  
 AP  
 AR  
 KA  
 KD  
 KU  
 KY

**AC** SCHEREN SCISSORS TIJERAS CISEAUX FORBICI

Hornhautscheren  
 Corneal Section Scissors  
 Pinzas-tijeras para córnea  
 Pincas ciseaux corneales  
 Forbici per cornea



**KATZIN**  
 AC 790/01  
 10,0 cm/4"

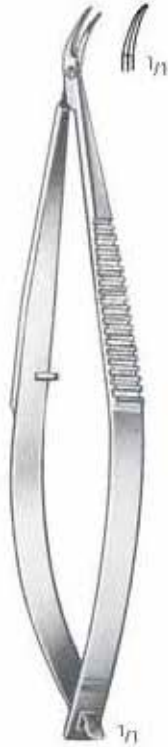

**KATZIN**  
 AC 790/02  
 10,0 cm/4"



**KATZIN**  
 AC 791/01  
 11,0 cm/4 1/8"

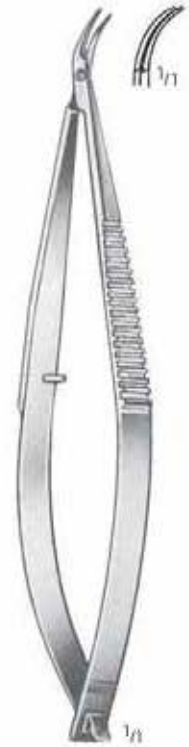

**KATZIN**  
 AC 791/02  
 11,0 cm/4 1/8"



**KATZIN-BARRAQUER**  
 AC 792/01  
 10,0 cm/4"



**KATZIN-BARRAQUER**  
 AC 792/02  
 10,0 cm/4"



**KATZIN**  
 AC 793/00  
 10,0 cm/4"



**KATZIN**  
 AC 793/01  
 10,0 cm/4"

SCHEREN SCISSORS TIJERAS CISEAUX FORBICI

Hornhautscheren, Mikroscheren  
 Corneal Section Scissors, Micro Scissors  
 Pinzas-tijeras para córnea, Micro Tijeras  
 Pincas ciseaux corneales, Micro-ciseaux  
 Forbici per cornea, Micro forbici



AC 794/12  
 12,0 cm/4<sup>3</sup>/<sub>4</sub>"



WESTCOTT  
 AC 797/01  
 11,5 cm/4<sup>1</sup>/<sub>2</sub>"



WESTCOTT  
 AC 797/02  
 11,5 cm/4<sup>1</sup>/<sub>2</sub>"

AA  
 AB  
 AC  
 AD  
 AE  
 AF  
 AG  
 AH  
 AI  
 AJ  
 AK  
 AL  
 AM  
 AN  
 AO  
 AP  
 AQ  
 AR  
 AS  
 AT  
 AU  
 AV  
 AW  
 AX  
 AY  
 AZ  
 BA  
 BB  
 BC  
 BD  
 BE  
 BF  
 BG  
 BH  
 BI  
 BJ  
 BK  
 BL  
 BM  
 BN  
 BO  
 BP  
 BQ  
 BR  
 BS  
 BT  
 BU  
 BV  
 BW  
 BX  
 BY  
 BZ  
 CA  
 CB  
 CC  
 CD  
 CE  
 CF  
 CG  
 CH  
 CI  
 CJ  
 CK  
 CL  
 CM  
 CN  
 CO  
 CP  
 CQ  
 CR  
 CS  
 CT  
 CU  
 CV  
 CW  
 CX  
 CY  
 CZ  
 DA  
 DB  
 DC  
 DD  
 DE  
 DF  
 DG  
 DH  
 DI  
 DJ  
 DK  
 DL  
 DM  
 DN  
 DO  
 DP  
 DQ  
 DR  
 DS  
 DT  
 DU  
 DV  
 DW  
 DX  
 DY  
 DZ  
 EA  
 EB  
 EC  
 ED  
 EE  
 EF  
 EG  
 EH  
 EI  
 EJ  
 EK  
 EL  
 EM  
 EN  
 EO  
 EP  
 EQ  
 ER  
 ES  
 ET  
 EU  
 EV  
 EW  
 EX  
 EY  
 EZ  
 FA  
 FB  
 FC  
 FD  
 FE  
 FF  
 FG  
 FH  
 FI  
 FJ  
 FK  
 FL  
 FM  
 FN  
 FO  
 FP  
 FQ  
 FR  
 FS  
 FT  
 FU  
 FV  
 FW  
 FX  
 FY  
 FZ  
 GA  
 GB  
 GC  
 GD  
 GE  
 GF  
 GG  
 GH  
 GI  
 GJ  
 GK  
 GL  
 GM  
 GN  
 GO  
 GP  
 GQ  
 GR  
 GS  
 GT  
 GU  
 GV  
 GW  
 GX  
 GY  
 GZ  
 HA  
 HB  
 HC  
 HD  
 HE  
 HF  
 HG  
 HH  
 HI  
 HJ  
 HK  
 HL  
 HM  
 HN  
 HO  
 HP  
 HQ  
 HR  
 HS  
 HT  
 HU  
 HV  
 HW  
 HX  
 HY  
 HZ  
 IA  
 IB  
 IC  
 ID  
 IE  
 IF  
 IG  
 IH  
 II  
 IJ  
 IK  
 IL  
 IM  
 IN  
 IO  
 IP  
 IQ  
 IR  
 IS  
 IT  
 IU  
 IV  
 IW  
 IX  
 IY  
 IZ  
 JA  
 JB  
 JC  
 JD  
 JE  
 JF  
 JG  
 JH  
 JI  
 JJ  
 JK  
 JL  
 JM  
 JN  
 JO  
 JP  
 JQ  
 JR  
 JS  
 JT  
 JU  
 JV  
 JW  
 JX  
 JY  
 JZ  
 KA  
 KB  
 KC  
 KD  
 KE  
 KF  
 KG  
 KH  
 KI  
 KJ  
 KK  
 KL  
 KM  
 KN  
 KO  
 KP  
 KQ  
 KR  
 KS  
 KT  
 KU  
 KV  
 KW  
 KX  
 KY  
 KZ  
 LA  
 LB  
 LC  
 LD  
 LE  
 LF  
 LG  
 LH  
 LI  
 LJ  
 LK  
 LL  
 LM  
 LN  
 LO  
 LP  
 LQ  
 LR  
 LS  
 LT  
 LU  
 LV  
 LW  
 LX  
 LY  
 LZ  
 MA  
 MB  
 MC  
 MD  
 ME  
 MF  
 MG  
 MH  
 MI  
 MJ  
 MK  
 ML  
 MM  
 MN  
 MO  
 MP  
 MQ  
 MR  
 MS  
 MT  
 MU  
 MV  
 MW  
 MX  
 MY  
 MZ  
 NA  
 NB  
 NC  
 ND  
 NE  
 NF  
 NG  
 NH  
 NI  
 NJ  
 NK  
 NL  
 NM  
 NN  
 NO  
 NP  
 NQ  
 NR  
 NS  
 NT  
 NU  
 NV  
 NW  
 NX  
 NY  
 NZ  
 OA  
 OB  
 OC  
 OD  
 OE  
 OF  
 OG  
 OH  
 OI  
 OJ  
 OK  
 OL  
 OM  
 ON  
 OO  
 OP  
 OQ  
 OR  
 OS  
 OT  
 OU  
 OV  
 OW  
 OX  
 OY  
 OZ  
 PA  
 PB  
 PC  
 PD  
 PE  
 PF  
 PG  
 PH  
 PI  
 PJ  
 PK  
 PL  
 PM  
 PN  
 PO  
 PP  
 PQ  
 PR  
 PS  
 PT  
 PU  
 PV  
 PW  
 PX  
 PY  
 PZ  
 QA  
 QB  
 QC  
 QD  
 QE  
 QF  
 QG  
 QH  
 QI  
 QJ  
 QK  
 QL  
 QM  
 QN  
 QO  
 QP  
 QQ  
 QR  
 QS  
 QT  
 QU  
 QV  
 QW  
 QX  
 QY  
 QZ  
 RA  
 RB  
 RC  
 RD  
 RE  
 RF  
 RG  
 RH  
 RI  
 RJ  
 RK  
 RL  
 RM  
 RN  
 RO  
 RP  
 RQ  
 RR  
 RS  
 RT  
 RU  
 RV  
 RW  
 RX  
 RY  
 RZ  
 SA  
 SB  
 SC  
 SD  
 SE  
 SF  
 SG  
 SH  
 SI  
 SJ  
 SK  
 SL  
 SM  
 SN  
 SO  
 SP  
 SQ  
 SR  
 SS  
 ST  
 SU  
 SV  
 SW  
 SX  
 SY  
 SZ  
 TA  
 TB  
 TC  
 TD  
 TE  
 TF  
 TG  
 TH  
 TI  
 TJ  
 TK  
 TL  
 TM  
 TN  
 TO  
 TP  
 TQ  
 TR  
 TS  
 TT  
 TU  
 TV  
 TW  
 TX  
 TY  
 TZ  
 UA  
 UB  
 UC  
 UD  
 UE  
 UF  
 UG  
 UH  
 UI  
 UJ  
 UK  
 UL  
 UM  
 UN  
 UO  
 UP  
 UQ  
 UR  
 US  
 UT  
 UY  
 UZ  
 VA  
 VB  
 VC  
 VD  
 VE  
 VF  
 VG  
 VH  
 VI  
 VJ  
 VK  
 VL  
 VM  
 VN  
 VO  
 VP  
 VQ  
 VR  
 VS  
 VT  
 VU  
 VV  
 VW  
 VX  
 VY  
 VZ  
 WA  
 WB  
 WC  
 WD  
 WE  
 WF  
 WG  
 WH  
 WI  
 WJ  
 WK  
 WL  
 WM  
 WN  
 WO  
 WP  
 WQ  
 WR  
 WS  
 WT  
 WU  
 WV  
 WW  
 WX  
 WY  
 WZ  
 XA  
 XB  
 XC  
 XD  
 XE  
 XF  
 XG  
 XH  
 XI  
 XJ  
 XK  
 XL  
 XM  
 XN  
 XO  
 XP  
 XQ  
 XR  
 XS  
 XT  
 XU  
 XV  
 XW  
 XX  
 XY  
 XZ  
 YA  
 YB  
 YC  
 YD  
 YE  
 YF  
 YG  
 YH  
 YI  
 YJ  
 YK  
 YL  
 YM  
 YN  
 YO  
 YP  
 YQ  
 YR  
 YS  
 YT  
 YU  
 YV  
 YW  
 YX  
 YZ  
 ZA  
 ZB  
 ZC  
 ZD  
 ZE  
 ZF  
 ZG  
 ZH  
 ZI  
 ZJ  
 ZK  
 ZL  
 ZM  
 ZN  
 ZO  
 ZP  
 ZQ  
 ZR  
 ZS  
 ZT  
 ZU  
 ZV  
 ZW  
 ZX  
 ZY  
 ZZ



**AC** SCHEREN SCISSORS TIJERAS CISEAUX FORBICI

Mikroscheren  
Micro Scissors  
Micro Tijeras  
Micro Ciseaux  
Micro Forbici

- >> Alle unsere Mikroscheren werden von Fachkräften mit jahrelanger Erfahrung hergestellt. Die Endkontrolle findet unter dem Mikroskop statt. Um Ihnen ein ermüdungsfreies Arbeiten zu ermöglichen, wird dem Federdruck größte Aufmerksamkeit gewidmet.
- >> Bitte wählen Sie unter Rund- oder Flachgriffscheren.

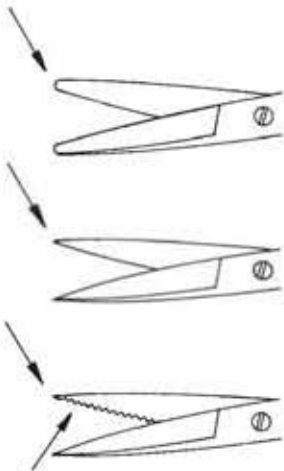

**Dissection:** **Gebogene Blätter, abgerundete Spitzen** ermöglichen eine gute und sichere Dissektion, ohne Nerven und Blutgefäße zu beschädigen.

**Adventitia:** **Gerade Blätter, sehr scharfe Spitzen** gewährleisten präzises Anfrischen von Gefäßenden.

**Nerve:** Ein Blatt ist **fein gezahnt**, um ein Herausgleiten des Nervs zu vermeiden.

- >> All our Micro Scissors are manufactured by skilled craftsmen with many years of experience. Final inspection is carried out under a microscope. Careful attention is paid to the closing pressure of the spring handle, to ensure precise work during surgeries, without fatigue.
- >> Round or flat handle scissors according to your preference.

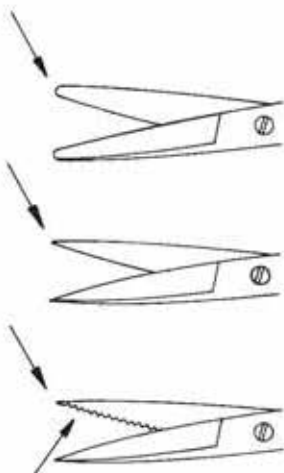

**Dissection:** **Curved blades, slightly rounded tips** ensure safe dissection without damage to nerves and vessels.

**Adventitia:** **Straight blades, very sharp tips** for finest trimming of vessel ends.

**Nerve:** One blade is **fine-toothed** to avoid slipping of the nerve.

SCHEREN SCISSORS TIJERAS CISEAUX FORBICI

Mikroscheren  
Micro Scissors  
Micro Tijeras  
Micro Ciseaux  
Micro Forbici

AA

AB

AC

AD

AE

AF

AK

AL

AM

AO

AP

AR

KA

KD

KU

KY



14,5 cm/5<sup>3</sup>/<sub>4</sub>"



**Dissection**  
AC 801/15

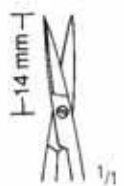

**Adventitia**  
AC 803/15



18,0 cm/7"

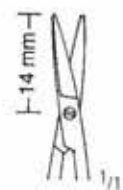

**Dissection**  
AC 801/18



**Adventitia**  
AC 803/18

AC SCHEREN SCISSORS TIJERAS CISEAUX FORBICI

Mikroscheren  
Micro Scissors  
Micro Tijeras  
Micro Ciseaux  
Micro Forbici

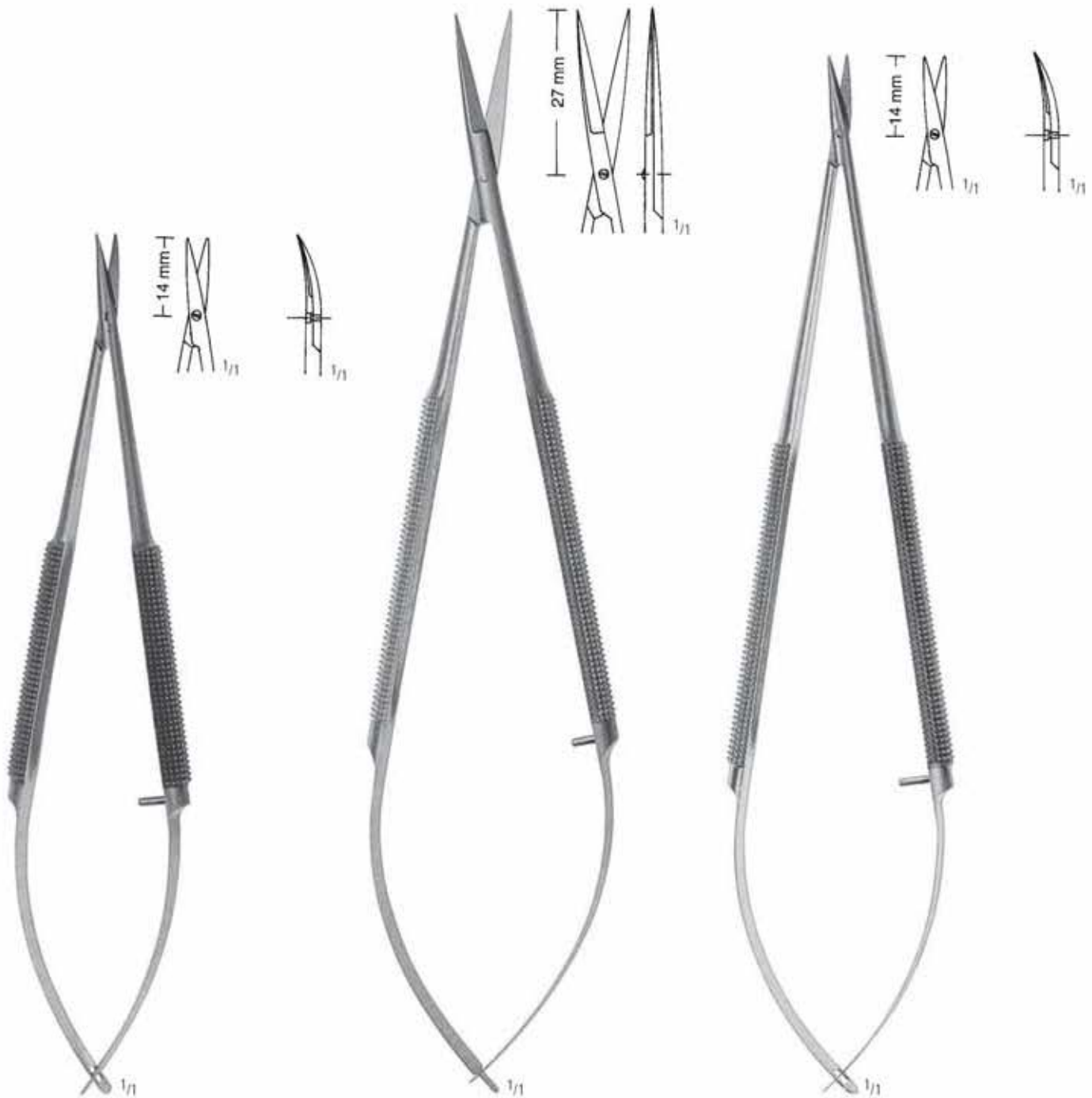

AC 807/14  
14,5 cm/5<sup>3</sup>/<sub>4</sub>"

AC 812/18  
18,0 cm/7"

AC 817/18  
18,0 cm/7"

SCHEREN SCISSORS TIJERAS CISEAUX FORBICI

Mikroscheren  
Micro Scissors  
Micro Tijeras  
Micro Ciseaux  
Micro Forbici

AA

AB

AC

AD

AE

AF

AK

AL

AM

AO

AP

AR

KA

KD

KU

KY



11,0 cm/4<sup>1</sup>/<sub>3</sub>"

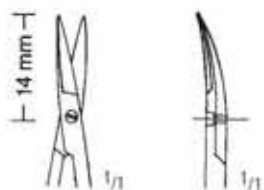

Dissection  
AC 821/11

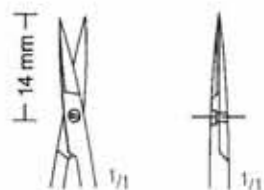

Adventitia  
AC 830/11



15,0 cm/6"

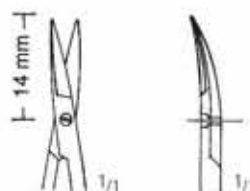

Dissection  
AC 823/15

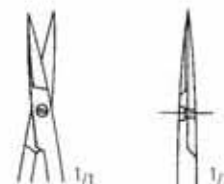

Adventitia  
AC 832/15

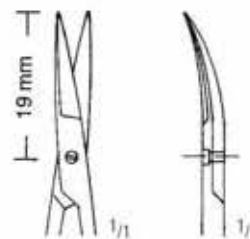

Dissection  
AC 825/15

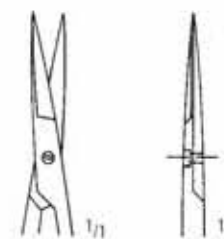

Adventitia  
AC 834/15

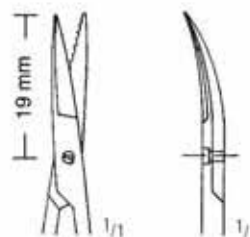

Dissection  
AC 827/15

>> Nerve >>

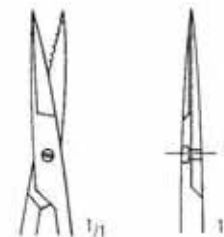

Adventitia  
AC 836/15

AC SCHEREN SCISSORS TIJERAS CISEAUX FORBICI

Mikroscheren  
Micro Scissors  
Micro Tijeras  
Micro Ciseaux  
Micro Forbici



18,5 cm/7<sup>1</sup>/<sub>3</sub>"



AC 850/19



AC 851/19



16,0 cm/6<sup>1</sup>/<sub>4</sub>"  
19,0 cm/7<sup>1</sup>/<sub>2</sub>"  
22,5 cm/9"



AC 860/16  
AC 860/20  
AC 860/22



AC 861/16  
AC 861/20  
AC 861/22



AC 862/16  
AC 862/20  
AC 862/22



AC 863/16  
AC 863/20  
AC 863/22



AC 864/16  
AC 864/20  
AC 864/22



AC 865/16  
AC 865/20  
AC 865/22



SCHEREN SCISSORS TIJERAS CISEAUX FORBICI

Mikroscheren  
Micro Scissors  
Micro Tijeras  
Micro Ciseaux  
Micro Forbici



18,0 cm/7"



AC 870/01  
25°



AC 870/02  
45°



AC 870/03  
60°



AC 870/04  
90°



AC 870/05  
125°



18,0 cm/7"



AC 871/01  
25°



AC 871/02  
45°



AC 871/03  
60°



AC 871/04  
90°



AC 871/05  
125°

AA  
AB  
AC  
AD  
AE  
AF  
AK  
AL  
AM  
AO  
AP  
AR  
KA  
KD  
KU  
KY

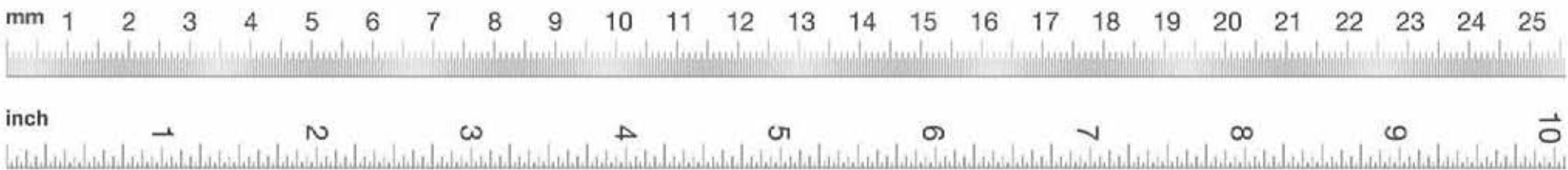

# nopa<sup>®</sup> TUC<sup>®</sup>

## SC Super Cut

### SUPER-CUT TUC



#### Besonderheit:

Nutzen Sie die Vorteile von Hartmetalleinsätzen.

**nopa TUC Super Cut** Scheren haben eine rasierklingscharfe Schneide, kombiniert mit einer mikrogezahnten Schneide.

>> Diese Scheren sind durch schwarz/goldene Ringe gekennzeichnet.

#### Features:

Use the advantages of Tungsten Carbide.

**nopa TUC Super Cut** scissors have a razor-like edge combined with one micro serrated blade.

>> Black/golden rings for easy identification.

#### Verfügbare Modelle / Available Patterns

Im Katalog durch \* markiert. / Marked in catalog with \*.

AC 902/14 SC STANDARD SCS TUC STR. SH/BL 14,5 CM SC
AC 903/14 SC STANDARD SCS TUC CVD. SH/BL 14,5 CM SC
AC 910/14 SC MAYO DISS. SCS TUC STR. BL/BL 14,5 CM SC
AC 910/17 SC MAYO DISS. SCS TUC STR. BL/BL 17,0 CM SC
AC 911/14 SC MAYO DISS. SCS TUC CVD. BL/BL 14,5 CM SC
AC 911/17 SC MAYO DISS. SCS TUC CVD. BL/BL 17,0 CM SC
AC 916/15 SC MAYO-STILLE SCS TUC STR. BL/BL 15,0 CM SC
AC 916/17 SC MAYO-STILLE SCS TUC STR. BL/BL 17,0 CM SC
AC 917/15 SC MAYO-STILLE SCS TUC CVD. BL/BL 15,0 CM SC
AC 917/17 SC MAYO-STILLE SCS TUC CVD. BL/BL 17,0 CM SC
AC 930/14 SC METZENBAUM SCS TUC STR. BL/BL 14,5 CM SC
AC 931/14 SC METZENBAUM SCS TUC CVD. BL/BL 14,5 CM SC
AC 940/18 SC METZENBAUM SCS TUC STR. BL/BL 18,0 CM SC
AC 940/20 SC METZENBAUM SCS TUC STR. BL/BL 20,0 CM SC
AC 941/18 SC METZENBAUM SCS TUC CVD. BL/BL 18,0 CM SC
AC 941/20 SC METZENBAUM SCS TUC CVD. BL/BL 20,0 CM SC
AC 941/23 SC METZENBAUM SCS TUC CVD. BL/BL 23,0 CM SC
AC 941/25 SC METZENBAUM SCS TUC CVD. BL/BL 25,0 CM SC
AC 941/28 SC METZENBAUM SCS TUC CVD. BL/BL 28,0 CM SC
AC 960/14 SC METZENBAUM-DEL. SCS TUC STR. BL/BL 14,5 CM SC
AC 961/14 SC METZENBAUM-DEL. SCS TUC CVD. BL/BL 14,5 CM SC
AC 970/18 SC METZENBAUM-DEL. SCS TUC STR. BL/BL 18,0 CM SC
AC 970/20 SC METZENBAUM-DEL. SCS TUC STR. BL/BL 20,0 CM SC
AC 971/18 SC METZENBAUM-DEL. SCS TUC CVD. BL/BL 18,0 CM SC
AC 971/20 SC METZENBAUM-DEL. SCS TUC CVD. BL/BL 20,0 CM SC
AC 974/11 SC STEVENS TENOTOMY SCS STR. POINTED 11,5 CM SC
AC 975/11 SC STEVENS TENOTOMY SCS CVD. POINTED 11,5 CM SC
AC 984/11 SC IRIS SCS TUC STR. SH/SH 11,5 CM SC
AC 985/11 SC IRIS SCS TUC CVD. SH/SH 11,5 CM SC

**AC** SCHEREN SCISSORS TIJERAS CISEAUX FORBICI

Scheren mit Hartmetalleinlagen  
 Scissors with Tungsten Carbide Inserts  
 Tijeras con filos de carburo de tungsteno  
 Ciseaux avec plaquettes en carbure de tungstène  
 Forbici con taglio al carburo di tungsteno

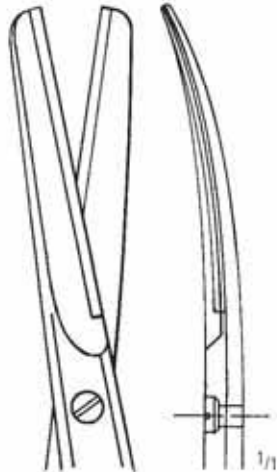

**STANDARD**  
 Fig. 1

straight: 14,5 cm/5<sup>3</sup>/<sub>4</sub>"  
 AC 900/14  
 curved: AC 901/14

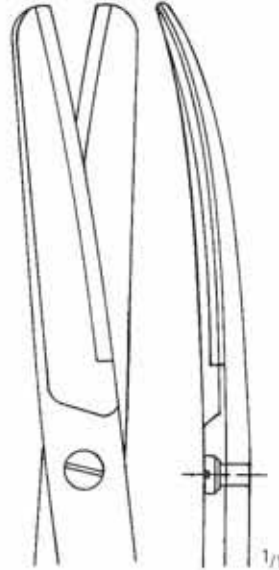

16,5 cm/6<sup>1</sup>/<sub>2</sub>"  
 AC 900/16  
 AC 901/16

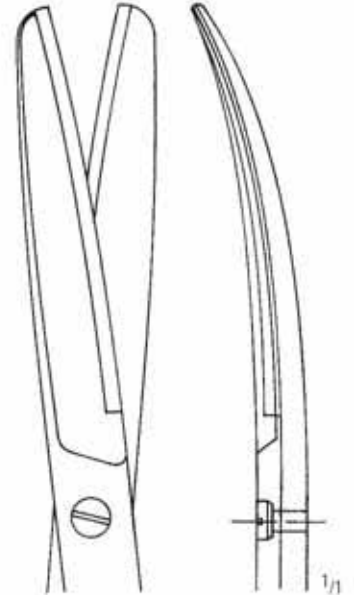

18,5 cm/7<sup>1</sup>/<sub>3</sub>"  
 AC 900/18  
 AC 901/18

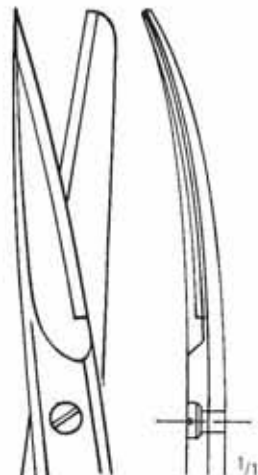

**STANDARD**  
 Fig. 2

straight: 14,5 cm/5<sup>3</sup>/<sub>4</sub>"  
 AC 902/14\*  
 curved: AC 903/14\*

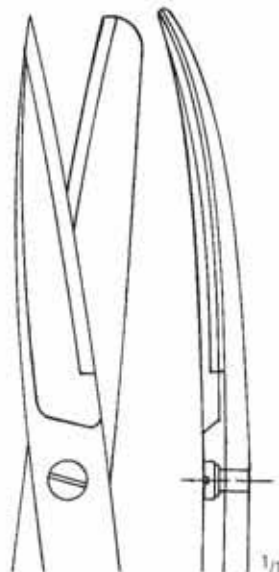

16,5 cm/6<sup>1</sup>/<sub>2</sub>"  
 AC 902/16  
 AC 903/16

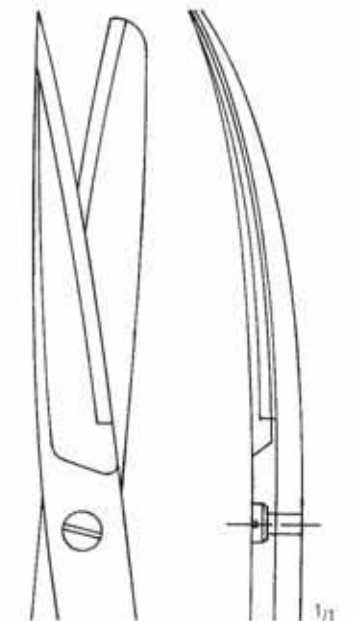

18,5 cm/7<sup>1</sup>/<sub>3</sub>"  
 AC 902/18  
 AC 903/18



SCHEREN SCISSORS TIJERAS CISEAUX FORBICI

Scheren mit Hartmetalleinlagen  
 Scissors with Tungsten Carbide Inserts  
 Tijeras con filos de carburo de tungsteno  
 Ciseaux avec plaquettes en carbure de tungstène  
 Forbici con taglio al carburo di tungsteno

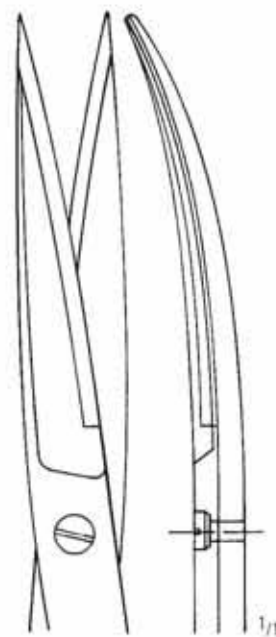
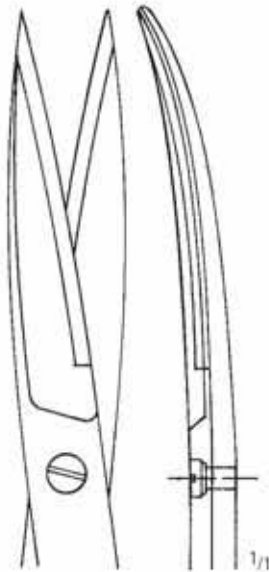
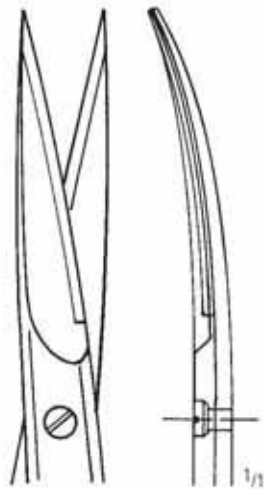

**STANDARD**  
 Fig. 3

straight: 14,5 cm/5<sup>3</sup>/<sub>4</sub>"  
 AC 904/14  
 curved: AC 905/14

16,5 cm/6<sup>1</sup>/<sub>2</sub>"  
 AC 904/16  
 AC 905/16

18,5 cm/7<sup>1</sup>/<sub>3</sub>"  
 AC 904/18  
 AC 905/18

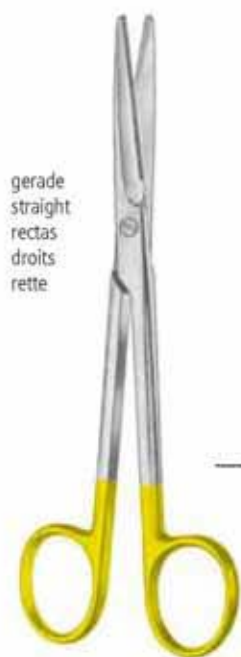

gerade  
 straight  
 rectas  
 droits  
 rette

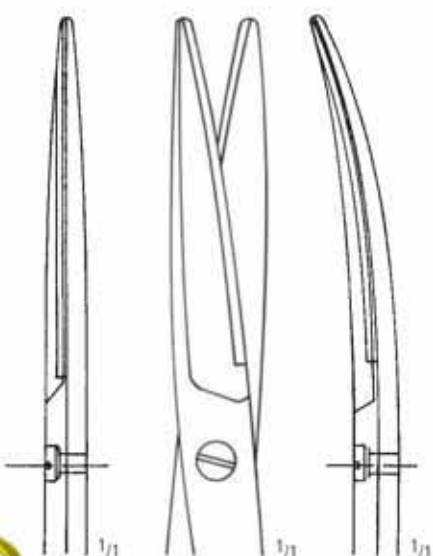

Original 17,0 cm

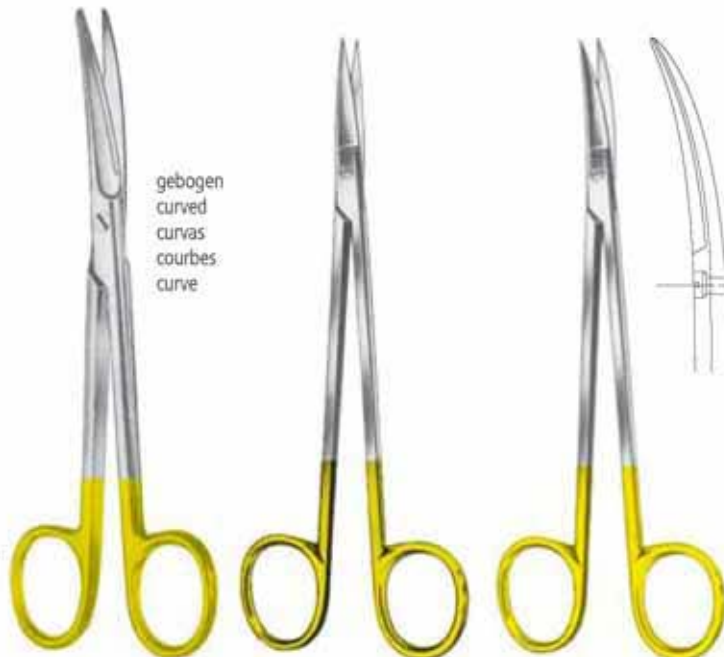

gebogen  
 curved  
 curvas  
 courbes  
 curve

**MAYO**

AC 910/14\*  
 AC 910/17\*  
 AC 910/23

14,5 cm/5<sup>1</sup>/<sub>2</sub>"  
 17,0 cm/6<sup>3</sup>/<sub>4</sub>"  
 23,0 cm/9"

**MAYO**

AC 911/14\*  
 AC 911/17\*  
 AC 911/23

**KELLY**

AC 912/16 16,0 cm/6<sup>1</sup>/<sub>4</sub>" AC 913/16

AA  
 AB  
 AC  
 AD  
 AE  
 AF  
 AG  
 AH  
 AI  
 AJ  
 AK  
 AL  
 AM  
 AN  
 AO  
 AP  
 AR  
 AS  
 AT  
 AU  
 AV  
 AW  
 AX  
 AY  
 AZ



**AC** SCHEREN SCISSORS TIJERAS CISEAUX FORBICI

Scheren mit Hartmetalleinlagen  
 Scissors with Tungsten Carbide Inserts  
 Tijeras con filos de carburo de tungsteno  
 Ciseaux avec plaquettes en carbure de tungstène  
 Forbici con taglio al carburo di tungsteno



**PARAMETRIUM**



AC 915/01  
22,5 cm/9"



AC 915/02  
23,0 cm/9"



**MAYO-STILLE**  
 AC 916/15\*  
 AC 916/17\*



Original 17,0 cm



15,0 cm/6"  
 17,0 cm/6<sup>3</sup>/<sub>4</sub>"



**MAYO-STILLE**  
 AC 917/15\*  
 AC 917/17\*

SCHEREN SCISSORS TIJERAS CISEAUX FORBICI

Scheren mit Hartmetalleinlagen  
 Scissors with Tungsten Carbide Inserts  
 Tijeras con filos de carburo de tungsteno  
 Ciseaux avec plaquettes en carbure de tungstène  
 Forbici con taglio al carburo di tungsteno

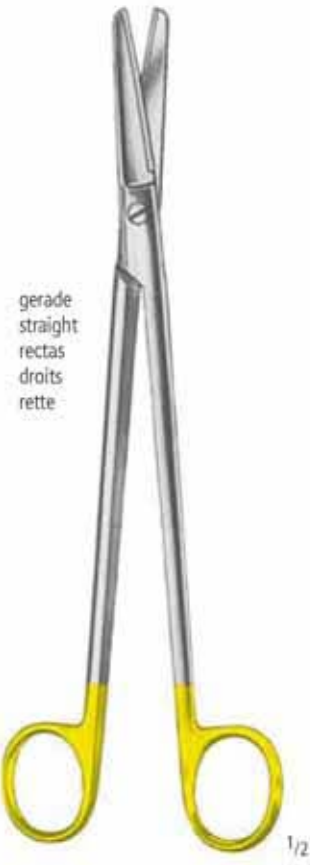

gerade  
straight  
rectas  
droits  
rette

**SIMS**  
 AC 918/23  
 23,0 cm/9"

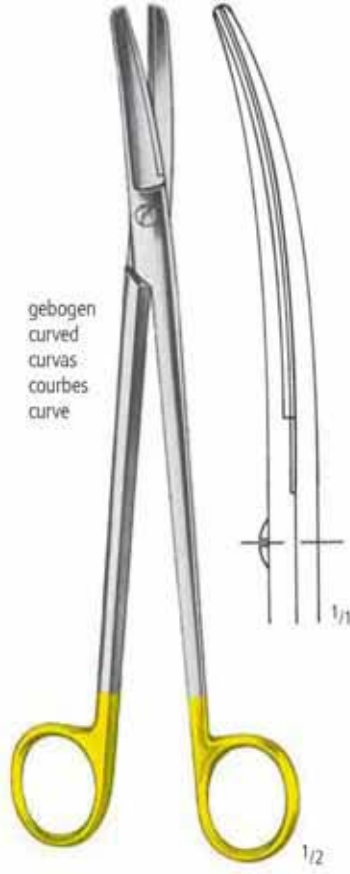

gebogen  
curved  
curvas  
courbes  
curve

**SIMS**  
 AC 919/23  
 23,0 cm/9"



AC 920/20  
 20,0 cm/8"



**CARDINALE**  
 AC 921/28  
 28,0 cm/11"



**METZENBAUM**  
 AC 922/11  
 11,5 cm/4 1/2"

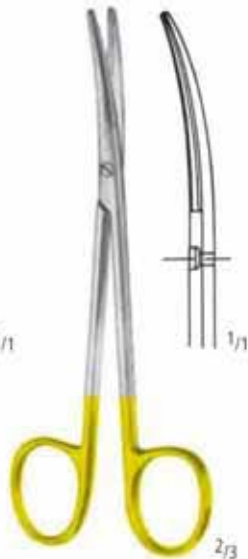

**METZENBAUM**  
 AC 923/11  
 11,5 cm/4 1/2"



**METZENBAUM**  
 AC 930/14\*  
 14,5 cm/5 3/4"



**METZENBAUM**  
 AC 931/14\*  
 14,5 cm/5 3/4"

AA  
 AB  
 AC  
 AD  
 AE  
 AF  
 AK  
 AL  
 AM  
 AO  
 AP  
 AR  
 KA  
 KD  
 KU  
 KY

**AC** SCHEREN SCISSORS TIJERAS CISEAUX FORBICI

Scheren mit Hartmetalleinlagen  
 Scissors with Tungsten Carbide Inserts  
 Tijeras con filos de carburo de tungsteno  
 Ciseaux avec plaquettes en carbure de tungstène  
 Forbici con taglio al carburo di tungsteno

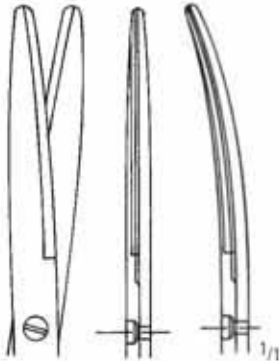

Original 18,0 cm

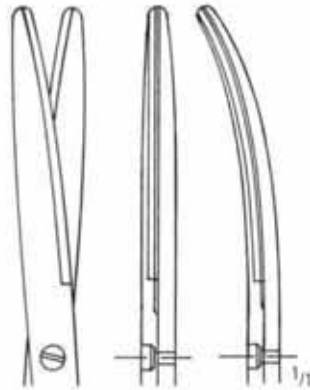

Original 20,0 cm

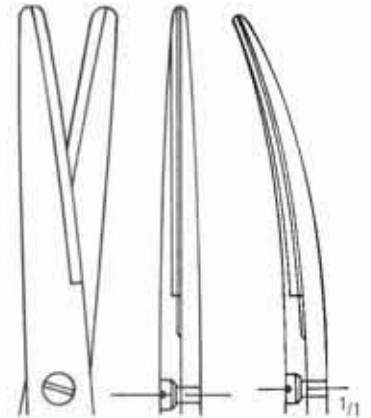

Original 23,0 cm



**nopa**  
**TUC®**

gerade  
 straight  
 rectas  
 droits  
 rette

gebogen  
 curved  
 curvas  
 courbes  
 curve

AC 940/18*	18,0 cm/7"	AC 941/18*
AC 940/20*	20,0 cm/8"	AC 941/20*
AC 940/23	23,0 cm/9"	AC 941/23*
AC 940/25	25,0 cm/10"	AC 941/25*
AC 940/28	28,0 cm/11"	AC 941/28*
AC 940/30	30,0 cm/12"	AC 941/30
	36,0 cm/14"	AC 941/36

**METZENBAUM**

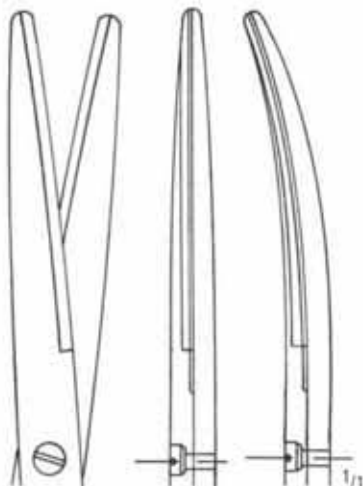

Original 25,0 cm

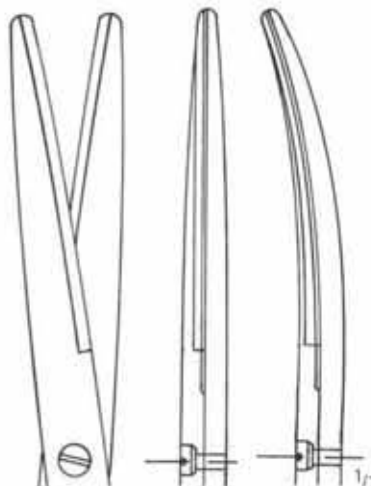

Original 28,0 cm

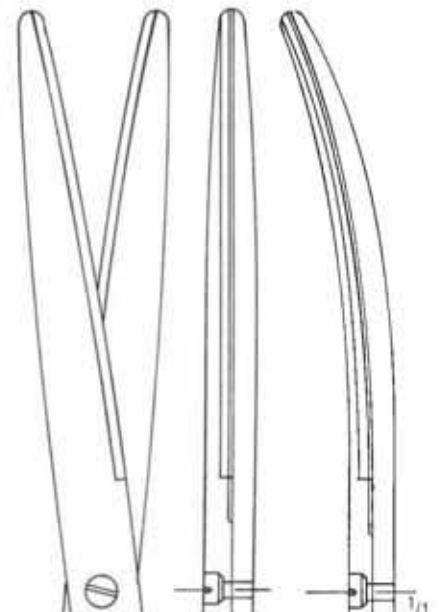

Original 30,0 cm

SCHEREN SCISSORS TIJERAS CISEAUX FORBICI

Scheren mit Hartmetalleinlagen  
 Scissors with Tungsten Carbide Inserts  
 Tijeras con filos de carburo de tungsteno  
 Ciseaux avec plaquettes en carbure de tungstène  
 Forbici con taglio al carburo di tungsteno



**POTTS-SMITH**  
 19,0 cm/7 1/2"

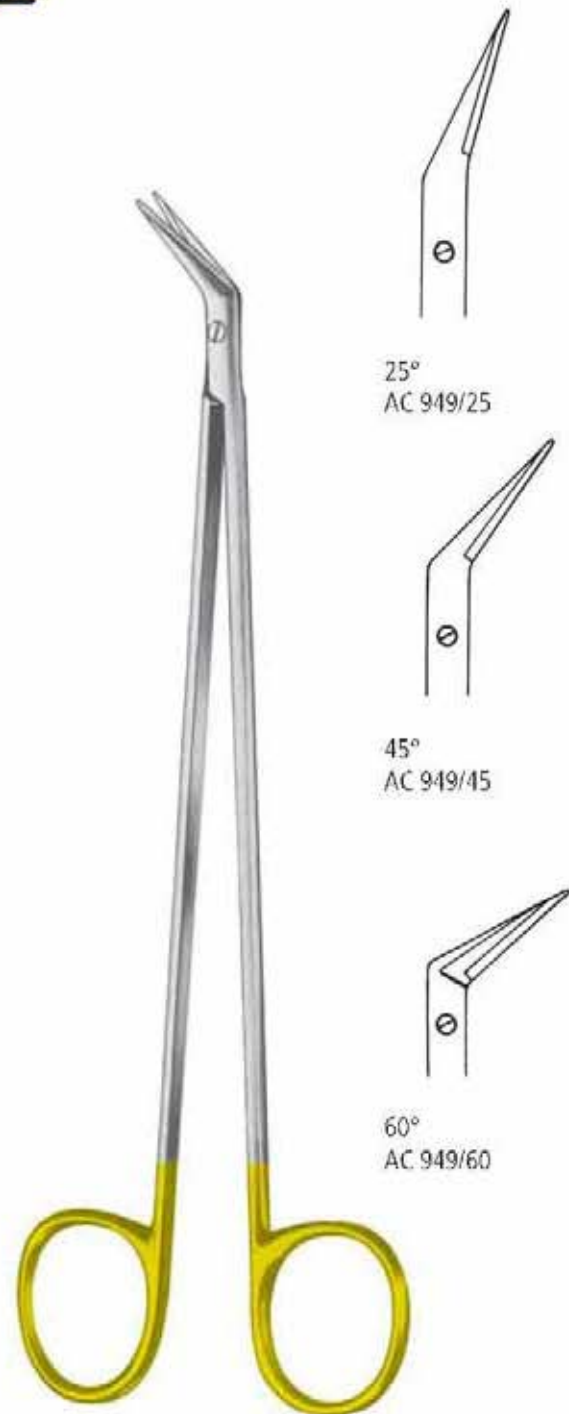
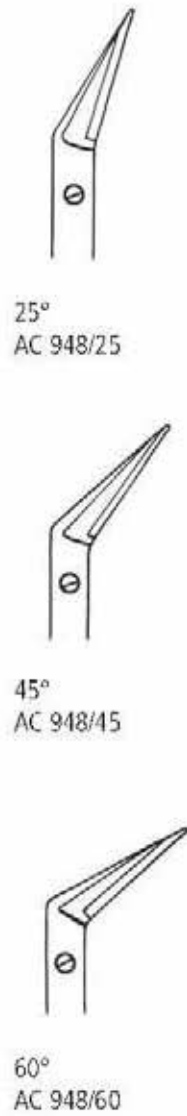

**DE BAKEY**  
 18,0 cm/7"

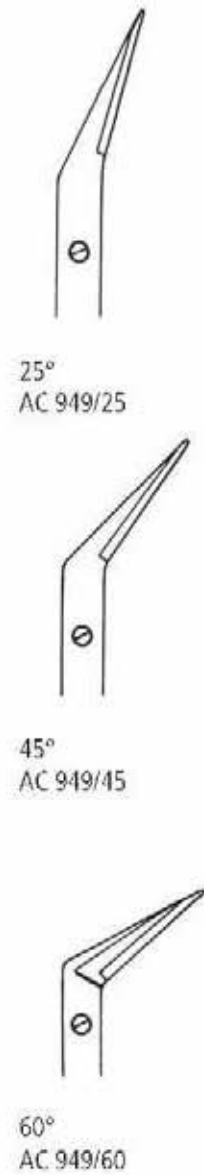

AA  
 AB  
 AC  
 AD  
 AE  
 AF  
 AG  
 AH  
 AI  
 AJ  
 AK  
 AL  
 AM  
 AN  
 AO  
 AP  
 AQ  
 AR  
 AS  
 AT  
 AU  
 AV  
 AW  
 AX  
 AY  
 AZ



**AC** SCHEREN SCISSORS TIJERAS CISEAUX FORBICI

Scheren mit Hartmetalleinlagen  
 Scissors with Tungsten Carbide Inserts  
 Tijeras con filos de carburo de tungsteno  
 Ciseaux avec plaquettes en carbure de tungstène  
 Forbici con taglio al carburo di tungsteno



**LEXER**  
 AC 952/16  
 16,0 cm/6<sup>1</sup>/<sub>4</sub>"

**LEXER**  
 AC 953/16  
 16,0 cm/6<sup>1</sup>/<sub>4</sub>"

nopa  
**TUC<sup>®</sup>**

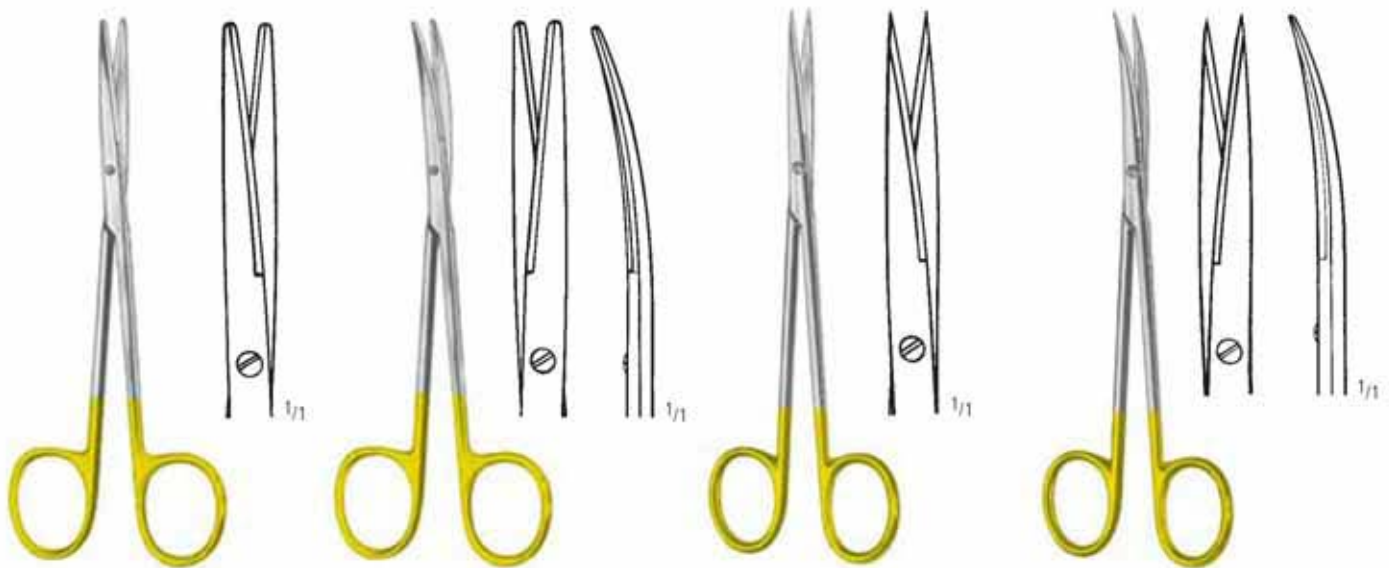

AC 960/14\*  
 14,5 cm/5<sup>3</sup>/<sub>4</sub>"

AC 961/14\*  
 14,5 cm/5<sup>3</sup>/<sub>4</sub>"

**METZENBAUM-DELICATE**

AC 962/14  
 14,5 cm/5<sup>3</sup>/<sub>4</sub>"

AC 963/14  
 14,5 cm/5<sup>3</sup>/<sub>4</sub>"



SCHEREN SCISSORS TIJERAS CISEAUX FORBICI

Scheren mit Hartmetalleinlagen  
 Scissors with Tungsten Carbide Inserts  
 Tijeras con filos de carburo de tungsteno  
 Ciseaux avec plaquettes en carbure de tungstène  
 Forbici con taglio al carburo di tungsteno

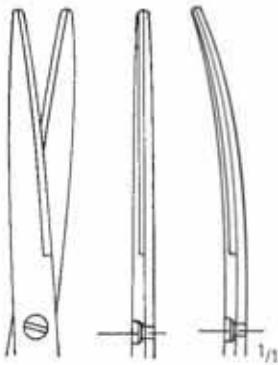

Original 18,0 cm

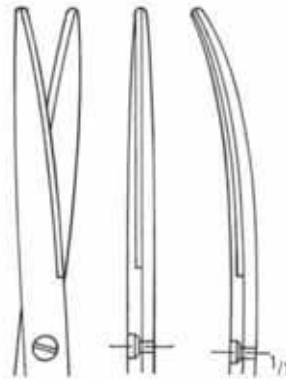

Original 20,0 cm

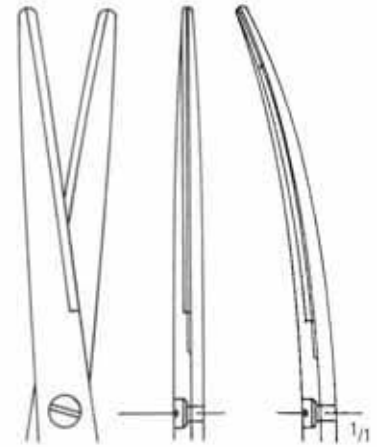

Original 23,0 cm



METZENBAUM-DELICATE



gerade  
 straight  
 rectas  
 droits  
 rette

gebogen  
 curved  
 curvas  
 courbes  
 curve

AC 970/18*	18,0 cm/7"	AC 971/18*
AC 970/20*	20,0 cm/8"	AC 971/20*
AC 970/23	23,0 cm/9"	AC 971/23
AC 970/25	25,0 cm/10"	AC 971/25
AC 970/28	28,0 cm/11"	AC 971/28

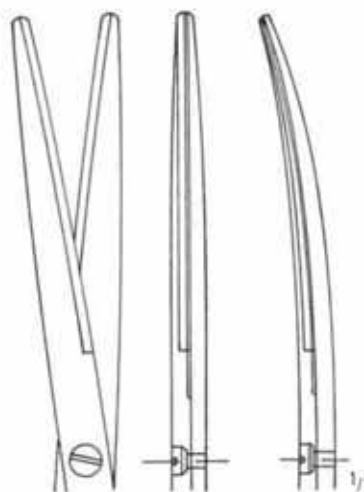

Original 25,0 cm

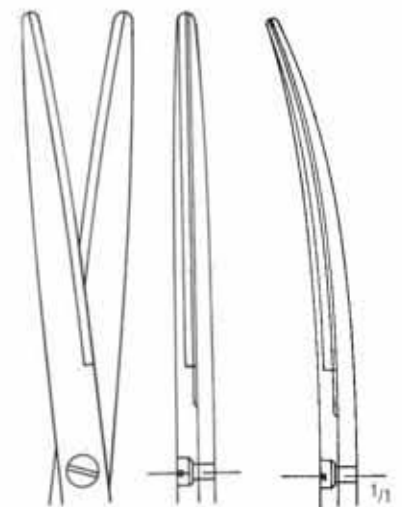

Original 28,0 cm

AA  
 AB  
 AC  
 AD  
 AE  
 AF  
 AG  
 AH  
 AI  
 AJ  
 AK  
 AL  
 AM  
 AN  
 AO  
 AP  
 AQ  
 AR  
 AS  
 AT  
 AU  
 AV  
 AW  
 AX  
 AY  
 AZ

**AC** SCHEREN SCISSORS TIJERAS CISEAUX FORBICI

Scheren mit Hartmetalleinlagen  
 Scissors with Tungsten Carbide Inserts  
 Tijeras con filos de carburo de tungsteno  
 Ciseaux avec plaquettes en carbure de tungstène  
 Forbici con taglio al carburo di tungsteno

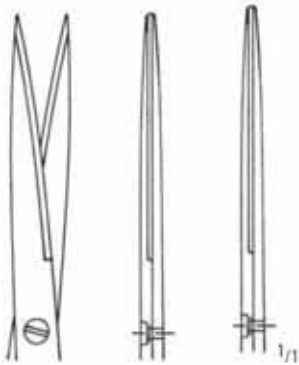

Original 18,0 cm

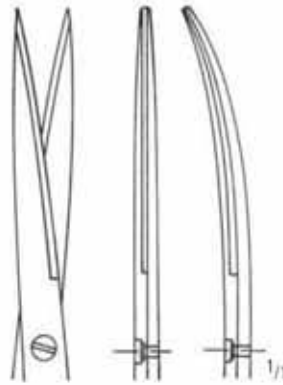

Original 20,0 cm

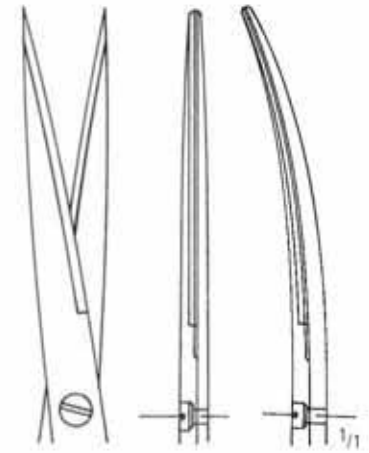

Original 23,0 cm



**METZENBAUM-DELICATE**

**nopa  
TUC<sup>®</sup>**

gerade  
straight  
rectas  
droits  
rette

gebogen  
curved  
curvas  
courbes  
curve

AC 972/18	18,0 cm/7"	AC 973/18
AC 972/20	20,0 cm/8"	AC 973/20
AC 972/23	23,0 cm/9"	AC 973/23
AC 972/25	25,0 cm/10"	AC 973/25
AC 972/28	28,0 cm/11"	AC 973/28

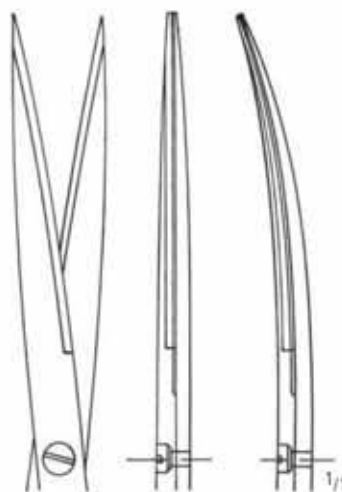

Original 25,0 cm

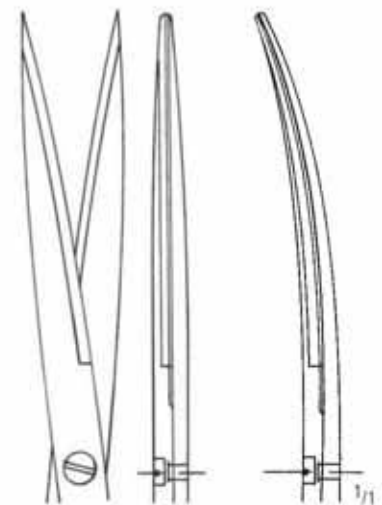

Original 28,0 cm

SCHEREN SCISSORS TIJERAS CISEAUX FORBICI

Scheren mit Hartmetalleinlagen  
 Scissors with Tungsten Carbide Inserts  
 Tijeras con filos de carburo de tungsteno  
 Ciseaux avec plaquettes en carbure de tungstène  
 Forbici con taglio al carburo di tungsteno



Original 11,5 cm

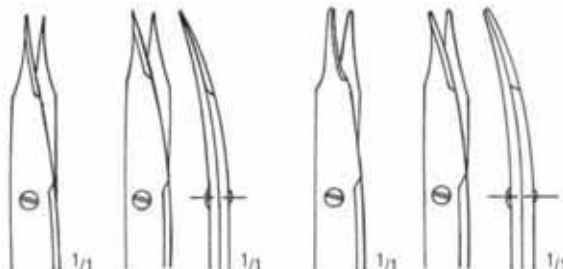

spitz  
pointed  
agudas  
pointues  
acuta

stumpf  
blunt  
romas  
mousses  
smussa

gerade  
straight  
rectas  
droits  
rette

gebogen  
curved  
curvas  
courbes  
curve

gerade  
straight  
rectas  
droits  
rette

gebogen  
curved  
curvas  
courbes  
curve

**STEVENS**

10,5 cm/4<sup>1</sup>/<sub>4</sub>"  
 11,5 cm/4<sup>1</sup>/<sub>2</sub>"

AC 974/10  
 AC 974/11\*

AC 975/10  
 AC 975/11\*

AC 976/10  
 AC 976/11

AC 977/10  
 AC 977/11

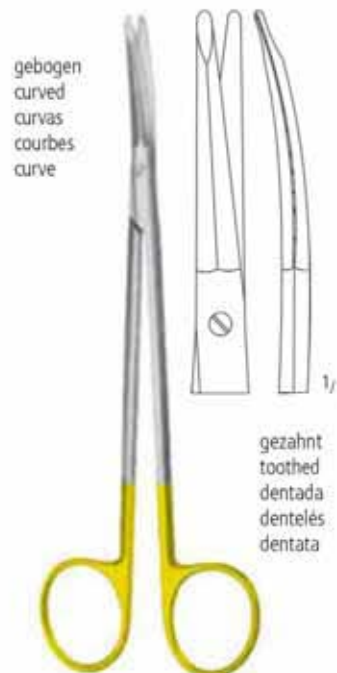

gebogen  
curved  
curvas  
courbes  
curve

gezahnt  
toothed  
dentada  
denteles  
dentata

**TOENNIS-ADSON-DELICATE**

AC 977/17  
 17,5 cm/7"

**GOLDMAN-FOX**

AC 980/13  
 13,0 cm/5"

AC 981/13  
 13,0 cm/5"

**KAYE**

AC 983/15  
 15,0 cm/6"

\* Auch erhältlich als SC \* Also available as SC

AA  
 AB  
 AC  
 AD  
 AE  
 AF  
 AG  
 AH  
 AI  
 AJ  
 AK  
 AL  
 AM  
 AN  
 AO  
 AP  
 AQ  
 AR  
 AS  
 AT  
 AU  
 AV  
 AW  
 AX  
 AY  
 AZ

AC SCHEREN SCISSORS TIJERAS CISEAUX FORBICI

Scheren mit Hartmetalleinlagen  
 Scissors with Tungsten Carbide Inserts  
 Tijeras con filos de carburo de tungsteno  
 Ciseaux avec plaquettes en carbure de tungstène  
 Forbici con taglio al carburo di tungsteno



AC 984/11\*  
 11,5 cm/4<sup>1</sup>/<sub>2</sub>"



AC 985/11\*  
 11,5 cm/4<sup>1</sup>/<sub>2</sub>"

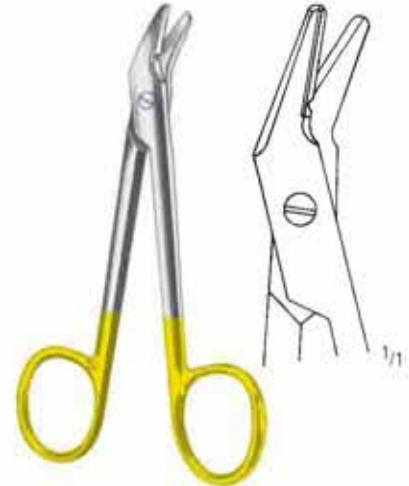

UNIVERSAL  
 AC 987/12  
 12,0 cm/4<sup>3</sup>/<sub>4</sub>"

nopa  
**TUC<sup>®</sup>**

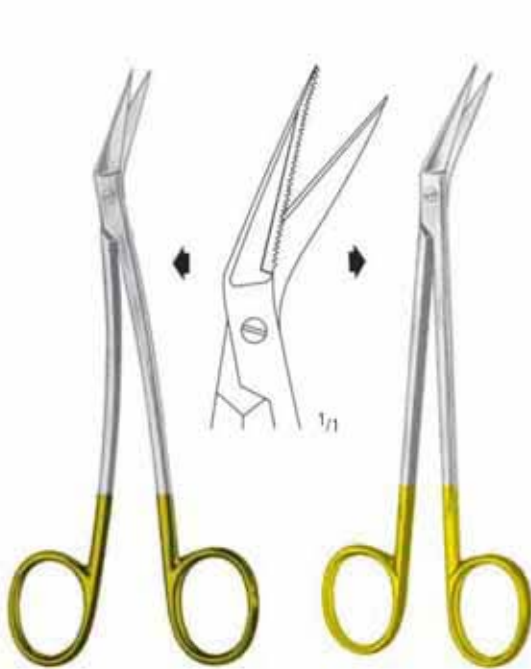

LOCKLIN  
 AC 988/16  
 16,5 cm/6<sup>1</sup>/<sub>2</sub>"

LOCKLIN  
 AC 989/16  
 16,5 cm/6<sup>1</sup>/<sub>2</sub>"



DEAN  
 AC 990/17  
 17,0 cm/6<sup>3</sup>/<sub>4</sub>"



LISTER  
 AC 999/18  
 18,0 cm/7"

---

SKALPELLE  
SCALPELS  
BISTURIES  
BISTOURIS  
BISTURI

AD

nopa<sup>®</sup> instruments







nopa<sup>®</sup> instruments

---



SKALPELLE SCALPELS BISTURIES BISTOURIS BISTURI

Skalpelli  
Scalpel Handles  
Mangos de bisturíes  
Manches pour bistouris  
Manici per bisturi



AD 009/03  
No. 3



AD 010/03  
No. 3



AD 010/04  
No. 4



AD 010/05  
No. 5K



AD 020/13  
No. 3L



AD 020/14  
No. 4L



AD 020/15  
No. 5L

AA  
AB  
AC  
AD  
AE  
AF  
AK  
AL  
AM  
AO  
AP  
AR  
KA  
KD  
KY

**AD** SKALPELLE SCALPELS BISTURIES BISTOURIS BISTURI

Skalpellgriffe  
 Scalpel Handles  
 Mangos de bisturles  
 Manches pour bistouris  
 Manici per bisturi



AD 025/07  
 No. 7



AD 027/07  
 No. 7K



AD 030/16



AD 031/16  
 No. 3



AD 031/21



**COLLIN**  
 AD 040/08  
 No. 8

hohl  
 hollow  
 hueco  
 creux  
 vuoto



**COLLIN**  
 AD 042/09  
 No. 9

Skalpelli-griffe, Skalpelli-klingen  
 Scalpel Handles, Scalpel Blades  
 Mangos de bisturías, Hojas de bisturías  
 Manches pour bistouris, Lames de bistouris  
 Manici per bisturi, Lame per bisturi

# MINI

Verpackungseinheit / packing unit = 10 St./pc.



Fig. 61  
AD 065/61



Fig. 62  
AD 065/62



Fig. 62S  
AD 065/63



Fig. 64  
AD 065/64



Fig. 65  
AD 065/65



Fig. 67  
AD 065/67



Fig. 69  
AD 065/69

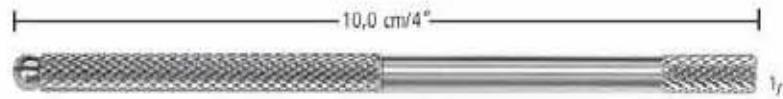

AD 065/10



AD 065/13



AD 065/15

AA

AB

AC

AD

AE

AF

AK

AL

AM

AO

AP

AR

KA

KD

KU

KY

**AD** SKALPELLE SCALPELS BISTURIES BISTOURIS BISTURI

Skalpellklingen  
Scalpel Blades  
Hojas de bisturís  
Lames pour bistouris  
Lame per bisturi

passend für die Griffe  
for handles  
para los mangos  
pour les manches  
per i manici

- AD 009/03
- AD 010/03
- AD 020/13
- AD 025/07
- AD 027/07
- AD 030/16
- AD 040/08



Fig. 10  
AD 075/10



Fig. 11  
AD 075/11



Fig. 12d  
AD 076/12



Fig. 15  
AD 075/15



Fig. 15c  
AD 076/15



passend für die Griffe  
for handles  
para los mangos  
pour les manches  
per i manici

- AD 010/04
- AD 020/14
- AD 042/09



Fig. 20  
AD 075/20



Fig. 21  
AD 075/21



Fig. 22  
AD 075/22



Fig. 23  
AD 075/23



Fig. 24  
AD 075/24



AD 080/01



SKALPELLE SCALPELS BISTURIES BISTOURIS BISTURI

Operations-Skalpelle  
 Operating Knives  
 Bisturios para operaciones  
 Bistouris pour opérations  
 Bisturi per interventi

AA  
 AB  
 AC  
**AD**  
 AE  
 AF  
 AK  
 AL  
 AM  
 AO  
 AP  
 AR  
 KA  
 KD  
 KU  
 KY



Fig.1  
 AD 200/01



Fig.3  
 AD 200/03



Fig.5  
 AD 200/05



Fig.7  
 AD 200/07



Fig.9  
 AD 200/09



Fig.10  
 AD 200/10



Fig.12  
 AD 200/12



Fig.14  
 AD 200/14



Fig.16  
 AD 200/16



Fig.18  
 AD 200/18



14,5 cm/5<sup>3</sup>/<sub>4</sub>"

Operations-Skalpelle  
 Operating Knives  
 Bisturías para operaciones  
 Bistouris pour opérations  
 Bisturi per interventi



**COLLIN**



Fig.1 AD 220/01    Fig.2 AD 220/02    Fig.3 AD 220/03



Fig.4 AD 220/04    Fig.5 AD 220/05    Fig.6 AD 220/06



**DIEFFENBACH**



Fig.1 AD 230/01    Fig.2 AD 230/02    Fig.3 AD 230/03



Fig.4 AD 230/04    Fig.5 AD 230/05    Fig.6 AD 230/06



Fig.7 AD 230/07    Fig.8 AD 230/08    Fig.9 AD 230/09    Fig.10 AD 230/10

SKALPELLE SCALPELS BISTURIES BISTOURIS BISTURI

Operations-Skalpelle  
 Operating Knives  
 Bisturías para operaciones  
 Bistouris pour opérations  
 Bisturi per interventi

AA  
 AB  
 AC  
**AD**  
 AE  
 AF  
 AK  
 AL  
 AM  
 AO  
 AP  
 AR  
 KA  
 KD  
 KU  
 KY



**DIEFFENBACH**



Fig.1  
AD 250/01



Fig.2  
AD 250/02



Fig.3  
AD 250/03



Fig.4  
AD 250/04



Fig.5  
AD 250/05



Fig.6  
AD 250/06



Fig.7  
AD 250/07



Fig.8  
AD 250/08



Fig.9  
AD 250/09



Fig.15  
AD 250/15



Fig.16  
AD 250/16

Amputationsmesser  
 Amputating Knives  
 Cuchillos para amputación  
 Couteaux à amputation  
 Coltelli per amputazione



Schnittlängen  
 length of blades  
 largos de hojas  
 longueurs des lames  
 lunghezza delle lame

cm	in.
12,0	4 <sup>3</sup> / <sub>4</sub>
13,0	5
16,0	6 <sup>1</sup> / <sub>4</sub>
17,0	6 <sup>3</sup> / <sub>4</sub>
19,0	7 <sup>1</sup> / <sub>2</sub>
20,0	8
22,0	8 <sup>3</sup> / <sub>4</sub>
28,0	11

**COLLIN**

**CATLIN**

**LISTON**

**LANGENBECK**

				AD 325/12
		AD 300/13		
		AD 300/16	AD 310/16	
				AD 320/17
		AD 300/19	AD 310/19	
				AD 320/20
		AD 300/22	AD 310/22	AD 320/22
		AD 300/28		

SKALPELLE SCALPELS BISTURIES BISTOURIS BISTURI

Organmesser, Hirnmesser  
 Post Mortem Knives, Brain Knives  
 Cuchillos para órganos y cerebro  
 Couteaux à autopsie et à cerveaux  
 Coltelli per autopsia e cervello



**WALB**  
AD 330/11

**WALB**  
AD 330/14

**WALB**  
AD 330/17

**VIRCHOW**  
AD 336/16

**VIRCHOW**  
AD 336/20

**VIRCHOW**  
AD 336/24

AA  
AB  
AC  
AD  
AE  
AF  
AK  
AL  
AM  
AO  
AP  
AR  
KA  
KD  
KY



Abszessmesser, Fistelmesser  
 Abscess Knives, Fistula Knives  
 Bisturías para abscesos y fistulas  
 Bistouris à abcès et fistules  
 Bisturi per ascessi e fistole



**DIEFFENBACH**  
 AD 400/13  
 13,0 cm/5"



**DIEFFENBACH**  
 AD 401/13  
 13,0 cm/5"



**SIMON**  
 23,5 cm/9 1/2"



Fig. 1  
 AD 430/01



Fig. 2  
 AD 430/02



Fig. 3  
 AD 430/03



Fig. 4  
 AD 430/04

SKALPELLE SCALPELS BISTURIES BISTOURIS BISTURI

Zahnfleischmesser, Transplantationsmesser, Dermatome  
 Gum Knives, Transplantation Knives, Dermatome  
 Bisturías para endías, Cuchillos para transplatación, Dermatomo  
 Couteaux à gencives, Couteaux à transplantation, Dermatome  
 Coltelli per gengive, Coltelli per trapianti, Dermatomo

AA  
AB  
AC  
AD  
AE  
AF  
AK  
AL  
AM  
AO  
AP  
AR  
KA  
KD  
KU  
KY



AD 435/01  
No. 1



AD 435/02  
No. 2



AD 435/03  
No. 3



**THIERSCH**  
AD 450/20  
20,0 cm/8"



**REHN**  
AD 455/25  
25,0 cm/10"

Dermatome  
Dermatomes  
Dermatomos  
Dermatomes  
Dermatomi



**WATSON**  
AD 495/30  
30,5 cm/12"  
0,1 - 2,0 mm

**HUMBY**  
AD 495/32  
32,0 cm/12<sup>3</sup>/<sub>4</sub>"  
0,1 - 1,2 mm



**SCHINK**  
AD 500/00  
30,0 cm/12"



AD 510/01

AD 510/02

SKALPELLE SCALPELS BISTURIES BISTOURIS BISTURI

Rasierklingen, Klingenbrecher  
 Razor Blades, Blade Breakers  
 Hojas de afeitár, Pinzas para romper hojas  
 Lames de rasoir, Pincettes pour casser les lames  
 Lamette da barba, Pinze per rompere la lamette

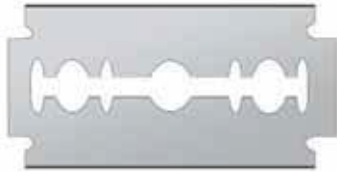

AD 540/00

RASIERKLINGEN, VERPACKUNGSEINHEIT 10 STÜCK  
 RAZOR BLADES, PACKING UNIT 10 PIECES  
 HOJAS DE AFEITAR, UNIDAD DE VENTA 10 PZ  
 LAMES DE RASOIR, UNITÉ À 10 PIÈCES  
 LAMETTE DA BARBA, UNITÀ DI VENDITA 10 PZ



**TROUTMAN-CHRIS**  
 AD 550/09  
 Ø 5,5 mm  
 9,0 cm/3 1/2"



**TROUTMAN-CHRIS**  
 AD 551/09  
 Ø 5,5 mm  
 9,0 cm/3 1/2"



AD 552/11  
 11,0 cm/4 1/8"



**CASTROVIEJO**  
 AD 554/13  
 Ø 8 mm  
 13,0 cm/5"

AA  
 AB  
 AC  
**AD**  
 AE  
 AF  
 AK  
 AL  
 AM  
 AO  
 AP  
 AR  
 KA  
 KD  
 KU  
 KY





---

NAHT  
SUTURE  
SUTURA  
SUTURE  
SUTURA

AE

nopa<sup>®</sup> instruments



Nadelhalter  
Needle Holders  
Porta-agujas  
Porte-aiguilles  
Portaghi



**BOYNTON**  
AE 036/12  
12,0 cm/4<sup>3</sup>/<sub>4</sub>"



**ARRUGA**  
16,0 cm/6<sup>1</sup>/<sub>4</sub>"



**DERF**  
AE 050/12  
12,0 cm/4<sup>3</sup>/<sub>4</sub>"



**DERF-CONVERSE**  
AE 052/12  
12,5 cm/5"



**COLLIER**  
AE 056/12  
12,5 cm/5"

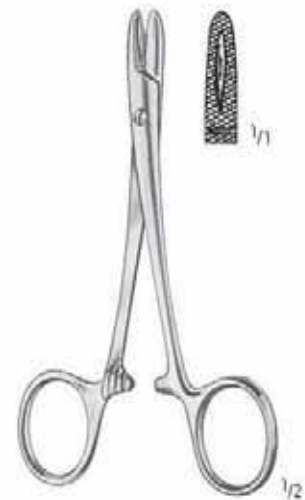

**DOYEN**  
AE 058/12  
12,5 cm/5"

NAHT SUTURE SUTURA SUTURE SUTURA

Nadelhalter  
Needle Holders  
Porta-agujas  
Porte-aiguilles  
Portaghi



**WEBSTER**  
AE 060/13  
13,0 cm/5"

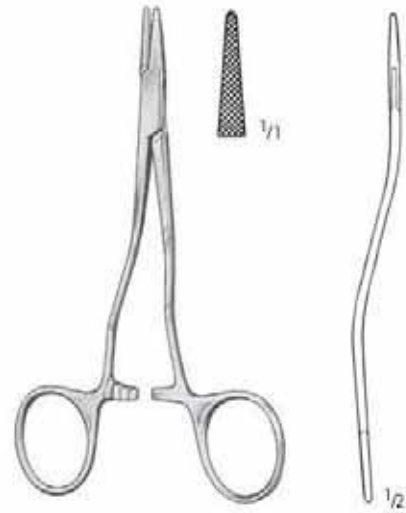

**KILNER**  
AE 063/13  
13,0 cm/5"

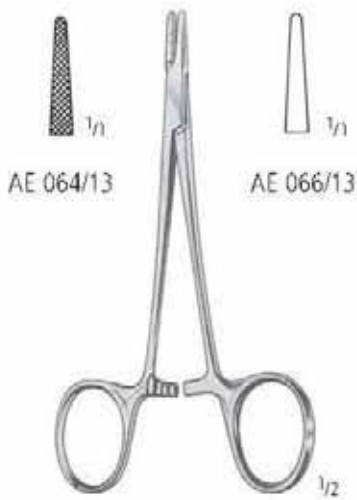

**HALSEY**  
13,0 cm/5"



**NEIVERT**  
AE 068/13  
13,0 cm/5"

AA  
AB  
AC  
AD  
AE  
AF  
AK  
AL  
AM  
AO  
AP  
AR  
KA  
KD  
KU  
KY

**AE** NAHT SUTURE SUTURA SUTURE SUTURA

Nadelhalter  
Needle Holders  
Porta-agujas  
Porte-aiguilles  
Portaghi



**CRILE-WOOD**  
15,0 cm/6"  
18,0 cm/7" AE 070/15  
AE 070/18



**BABY-CRILE-WOOD**  
15,0 cm/6" AE 072/15



**CARROLL**  
15,0 cm/6" AE 074/15



**CRILE-MURRAY**  
15,0 cm/6" AE 076/15

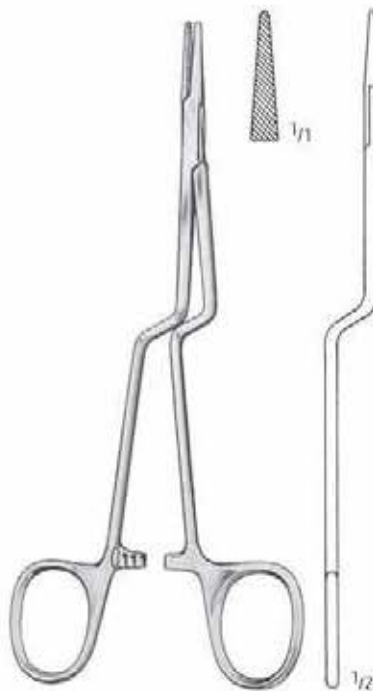

**JACOBSON**  
18,0 cm/7" AE 077/18



**BOZEMANN**



AE 079/20  
20,0 cm/8"



AE 079/24  
24,0 cm/9 1/2"



AE 079/26  
26,0 cm/10 1/2"

NAHT SUTURE SUTURA SUTURE SUTURA

Nadelhalter  
Needle Holders  
Porta-agujas  
Porte-aiguilles  
Portaghi



AE 080/18  
18,0 cm/7"

AE 080/26  
26,0 cm/10<sup>1</sup>/<sub>2</sub>"

**SAROT**

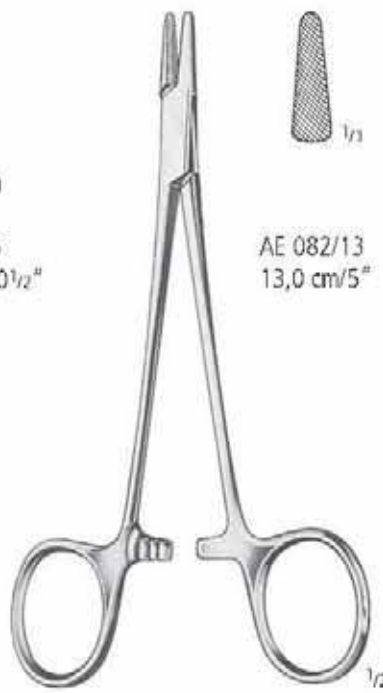

AE 082/13  
13,0 cm/5"

AE 082/18  
18,0 cm/7"

**BROWN**



**NEW ORLEANS**  
AE 086/18  
18,0 cm/7"



AE 088/15  
15,0 cm/6"

AE 088/17  
17,0 cm/6<sup>3</sup>/<sub>4</sub>"

**SENNING**  
(Schwed. Modell)

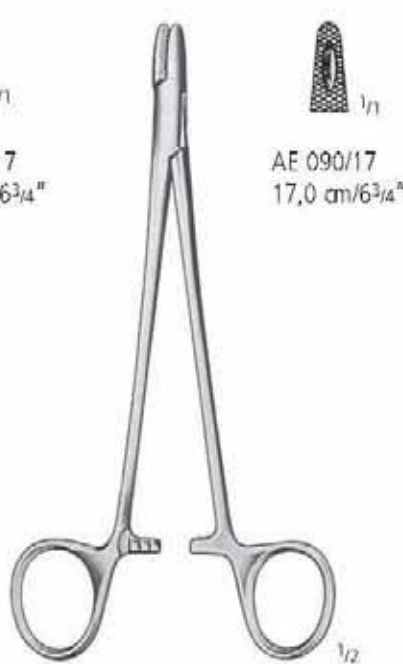

AE 090/17  
17,0 cm/6<sup>3</sup>/<sub>4</sub>"

**M.G.H.**  
(Mass.-General-Hospital)



**ADSON**  
AE 094/18  
18,0 cm/7"

AA  
AB  
AC  
AD  
**AE**  
AF  
AK  
AL  
AM  
AO  
AP  
AR  
KA  
KD  
KU  
KY



**AE** NAHT SUTURE SUTURA SUTURE SUTURA

Nadelhalter  
Needle Holders  
Porta-agujas  
Porte-aiguilles  
Portaghi



**MAYO-HEGAR**



AE 100/14  
14,0 cm/5 1/2"



AE 100/16  
16,0 cm/6 1/4"



AE 100/18  
18,0 cm/7"



AE 100/20  
20,0 cm/8"



AE 100/24  
24,0 cm/9 1/2"



AE 100/26  
26,0 cm/10 1/4"



AE 100/30  
30,0 cm/12"

**MAYO-HEGAR-DELICATE**



AE 110/16  
16,0 cm/6 1/4"



AE 110/18  
18,0 cm/7"



AE 110/20  
20,0 cm/8"

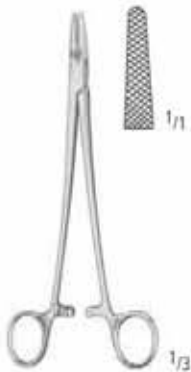

**BAUMGARTNER**  
AE 112/14  
14,0 cm/5 1/2"



**HEANEY**

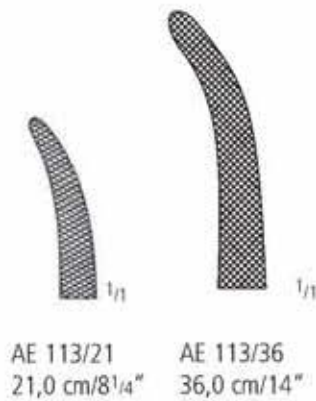

AE 113/21  
21,0 cm/8 1/4"

AE 113/36  
36,0 cm/14"



**JAMESON**  
AE 126/23  
23,5 cm/9 1/3"



**MASSON**  
AE 130/27  
27,0 cm/10 3/4"

NAHT SUTURE SUTURA SUTURE SUTURA

Nadelhalter  
Needle Holders  
Porta-agujas  
Porte-aiguilles  
Portaghi

AA  
AB  
AC  
AD  
AE  
AF  
AK  
AL  
AM  
AO  
AP  
AR  
KA  
KD  
KY



**FINOCCHIETTO**  
AE 136/27  
27,0 cm/10<sup>3</sup>/<sub>4</sub>"



**WANGENSTEEN**  
AE 140/27  
27,0 cm/10<sup>3</sup>/<sub>4</sub>"



**WANGENSTEEN-DELICATE**  
AE 142/27  
27,5 cm/10<sup>1</sup>/<sub>2</sub>"

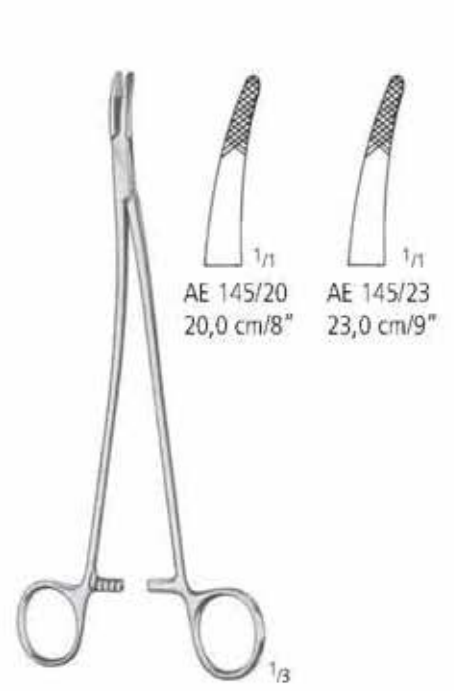

**STRATTE**

AE 145/20  
20,0 cm/8"

AE 145/23  
23,0 cm/9"



**WERTHEIM**  
20,0 cm/8" AE 147/20  
24,0 cm/9<sup>1</sup>/<sub>2</sub>" AE 147/24



**OLSEN-HEGAR**

AE 150/14  
14,0 cm/5<sup>1</sup>/<sub>2</sub>"

AE 150/17  
17,0 cm/6<sup>3</sup>/<sub>4</sub>"

AE 150/19  
19,0 cm/7<sup>1</sup>/<sub>2</sub>"

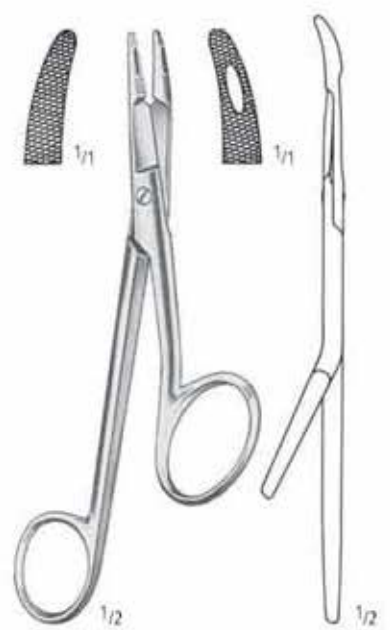

**GILLIES**  
AE 155/16  
16,0 cm/6<sup>1</sup>/<sub>4</sub>"

**AE** NAHT SUTURE SUTURA SUTURE SUTURA

Nadelhalter  
Needle Holders  
Porta-agujas  
Porte-aiguilles  
Portaghi



**MATHIEU**



AE 200/14  
14,0 cm/5 1/2"



AE 200/17  
17,0 cm/6 3/4"



AE 200/20  
20,0 cm/8"



AE 200/24  
24,0 cm/9 1/2"



**MATHIEU-DELICATE**



AE 210/14  
14,0 cm/5 1/2"



AE 210/17  
17,0 cm/6 3/4"



**MATHIEU**



AE 214/17  
17,0 cm/6 3/4"



AE 214/20  
20,0 cm/8"



AE 214/24  
24,0 cm/9 1/2"

NAHT SUTURE SUTURA SUTURE SUTURA

Nadelhalter  
Needle Holders  
Porta-agujas  
Porte-aiguilles  
Portaghi



**LICHTENBERG**



AE 216/20  
20,0 cm/8"



AE 216/25  
25,0 cm/10"



**ZWEIFEL**



AE 222/20  
20,0 cm/8"



AE 222/23  
23,0 cm/9"



**CRILE**  
AE 224/15  
15,0 cm/6"



AA  
AB  
AC  
AD  
**AE**  
AF  
AK  
AL  
AM  
AO  
AP  
AR  
KA  
KD  
KU  
KY

Nadelhalter  
 Needle Holders  
 Porta-agujas  
 Porte-aiguilles  
 Portaghi



**TOENNIS**  
 AE 226/18  
 18,0 cm/7"



**LANGENBECK**

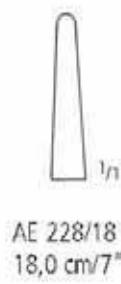

AE 228/18  
 18,0 cm/7"

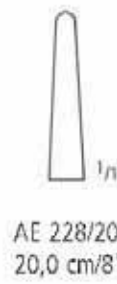

AE 228/20  
 20,0 cm/8"



**HÖSEL**  
 AE 230/25  
 25,0 cm/10"



NAHT SUTURE SUTURA SUTURE SUTURA

Nadelhalter  
Needle Holders  
Porta-agujas  
Porte-aiguilles  
Portaghi

AA

AB

AC

AD

**AE**

AF

AK

AL

AM

AO

AP

AR

KA

KD

KU

KY



AE 301/01



AE 301/02



AE 301/03

**YOUNG-HRYNTSCHAK**

AE 300/24

24,0 cm/9 1/2"

mit 1 Nadel AE 301/01  
with 1 needle AE 301/01  
con 1 aguja AE 301/01  
avec 1 aiguille AE 301/01  
con 1 ago AE 301/01

**AE** NAHT SUTURE SUTURA SUTURE SUTURA

Hartmetalleinsatzplättchen mit Pyramidenprofil  
 Tungsten Carbide Tips with pyramidal profile  
 Bocas de carburo de tungsteno con perfil de estructura piramidal  
 Plaquettes en carbure de tungstène avec profil pyramidal  
 Placche di carburo di tungsteno con profilo in forma piramidale

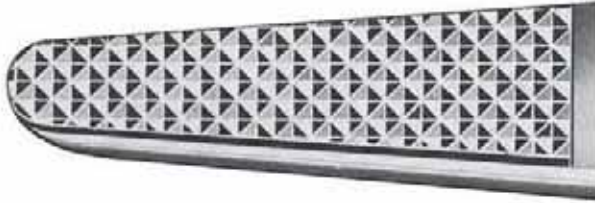

Teilung:	0,5 mm	Für Nahtmaterial 3/0 und größer
Serration:	0,5 mm	For suture sizes 3/0 and larger
Graduación:	0,5 mm	Para sutura 3/0 y más grande
Graduation:	0,5 mm	Pour suture 3/0 et plus grand
Graduazione:	0,5 mm	Per sutura 3/0 e più grande

**"STANDARD"**

(Mayo-Hegar, Mathieu, Bozeman,  
 New Orleans, Stratte, etc.)

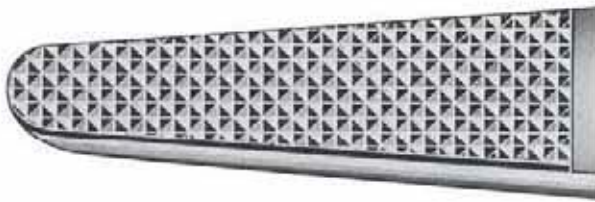

Teilung:	0,4 mm	Für Nahtmaterial zwischen 3/0 und 6/0
Serration:	0,4 mm	For suture sizes between 3/0 and 6/0
Graduación:	0,4 mm	Para suturas entre 3/0 y 6/0
Graduation:	0,4 mm	Pour sutures entre 3/0 et 6/0
Graduazione:	0,4 mm	Per sutura tra 3/0 e 6/0

**"FINE"**

(Crile-Wood, Halsey, DeBakey, Ryder, etc.)



Teilung:	0,2 mm	Für Nahtmaterial zwischen 7/0 und 10/0
Serration:	0,2 mm	For suture sizes between 7/0 and 10/0
Graduación:	0,2 mm	Para suturas entre 7/0 y 10/0
Graduation:	0,2 mm	Pour sutures entre 7/0 et 10/0
Graduazione:	0,2 mm	Per sutura tra 7/0 e 10/0

**"MICRO"**

(Micro Ryder, Microvascular, Castroviejo, etc.)



glatt	Für extrem feines Nahtmaterial
smooth	For the smallest suture sizes available
lisa	Para suturas extremamente finas
lisses	Pour matériel de suture extrêmement fin
liscio	Per materiale di sutura finissima

**"SMOOTH"**

(Eufrate Pasqué, Castroviejo, Jacobson, etc.)

NAHT SUTURE SUTURA SUTURE SUTURA

nopa-Service, Ersatzteile und Aufarbeitung aller Fabrikate  
 nopa-Service, Spare Inserts and Refurbishing of all brands  
 Servicio-nopa, piezas de recambio y renovar de todas las marcas  
 Service-nopa, pièces de rechange et remise à neuf de toutes les marques  
 Servizio-nopa, pezzi di ricambio e riparazione di tutte le marche

AA  
AB  
AC  
AD  
AE  
AF  
AK  
AL  
AM  
AO  
AP  
AR  
KA  
KD  
KU  
KY

**TUC-Einsätze**  
**TUC-Inserts**  
**TUC-Bocas**  
**TUC-Plaquettes**  
**TUC-Placche**

AE 380/15	Smooth, 15 mm
AE 380/17	Smooth, 17 mm
AE 380/19	Smooth, 19 mm
AE 382/15	Micro, 0.2, 15 mm
AE 382/17	Micro, 0.2, 17 mm
AE 382/19	Micro, 0.2, 19 mm
AE 384/15	Fine, 0.4, 15 mm
AE 384/17	Fine, 0.4, 17 mm
AE 384/19	Fine, 0.4, 19 mm
AE 385/15	Standard, 0.5, 15 mm
AE 385/17	Standard, 0.5, 17 mm
AE 385/19	Standard, 0.5, 19 mm

**Reparaturservice**  
**Repair-Service**  
**Servicio de reparación**  
**Service de réparation**  
**Servizio di riparazione**

AE 390/00  
 neue Plättchen einsetzen, aufarbeiten, Ringe vergolden  
 replacement of inserts, refurbishing, gold handles refinished  
 soldar bocas nuevas, reparar, dorar los anillos  
 brasage des nouvelles plaquettes, remise à neuf, redorer les anneaux  
 saldare placche nuove, rinnovare, dorare gli anelli

AE 390/01  
 neue Plättchen einsetzen, aufarbeiten  
 replacement of inserts, refurbishing  
 soldar bocas nuevas, reparar  
 brasage des nouvelles plaquettes, remise à neuf  
 saldare placche nuove, rinnovare

AE 390/02  
 neue Plättchen einsetzen  
 replacement of inserts  
 soldar bocas nuevas  
 brasage des nouvelles plaquettes  
 saldare placche nuove

AE 390/03  
 aufarbeiten  
 refurbishing  
 reparar  
 remise à neuf  
 rinnovare

AE 390/04  
 Ringe vergolden  
 gold handles refinished  
 dorar los anillos  
 redorer les anneaux  
 dorare gli anelli

**AE** NAHT SUTURE SUTURA SUTURE SUTURA

Nadelhalter mit Hartmetalleinsätzen  
 Needle Holders with Tungsten Carbide Inserts  
 Porta-agujas con bocas de carburo de Tungsteno  
 Porte-aiguilles à mors en carbure de tungstène  
 Portaghi con placche di carburo di tungsteno



**MAYO-HEGAR**



AE 400/14  
14,0 cm/5<sup>1</sup>/<sub>2</sub>"



AE 400/16  
16,0 cm/6<sup>1</sup>/<sub>4</sub>"



AE 400/18  
18,0 cm/7"



AE 400/20  
20,0 cm/8"



AE 400/24  
24,0 cm/9<sup>1</sup>/<sub>2</sub>"



AE 400/26  
26,0 cm/10<sup>1</sup>/<sub>2</sub>"



AE 400/30  
30,0 cm/12"



AE 400/36  
36,0 cm/14"

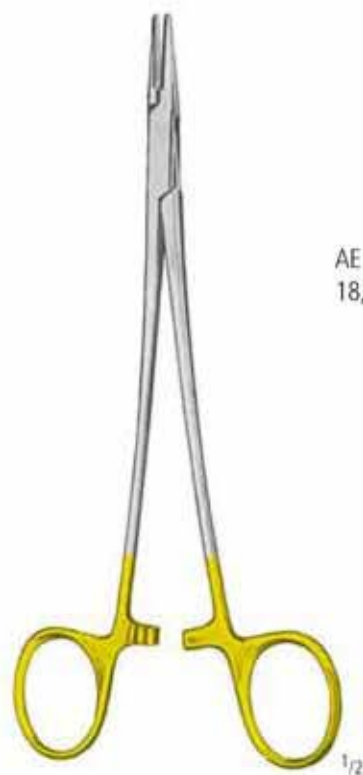

**DE-BAKEY  
 (MAYO-HEGAR-DELICATE)**



AE 420/18  
18,0 cm/7"



AE 420/20  
20,0 cm/8"



AE 420/23  
23,0 cm/9"



AE 420/26  
26,0 cm/10<sup>1</sup>/<sub>2</sub>"



AE 420/31  
31,0 cm/12<sup>1</sup>/<sub>4</sub>"

NAHT SUTURE SUTURA SUTURE SUTURA

Nadelhalter mit Hartmetalleinsätzen  
 Needle Holders with Tungsten Carbide Inserts  
 Porta-agujas con bocas de carburo de Tungsteno  
 Porte-aiguilles à mors en carbure de tungstène  
 Portaghi con placche di carburo di tungsteno



RYDER/FRENCH-EYE

AE 430/13 13,0 cm/5"	AE 430/15 15,0 cm/6"	AE 430/18 18,0 cm/7"	AE 430/20 20,0 cm/8"	AE 430/23 23,0 cm/9"	AE 430/26 26,0 cm/10 <sup>1/2</sup> "	

MICRO RYDER

AE 434/13 13,0 cm/5"	AE 434/15 15,0 cm/6"	AE 434/18 18,0 cm/7"	AE 434/20 20,0 cm/8"	AE 434/23 23,0 cm/9"	AE 434/26 26,0 cm/10 <sup>1/2</sup> "



AE 436/14 14,0 cm/5 <sup>1/2</sup> "	AE 436/18 18,0 cm/7"	AE 436/20 20,0 cm/8"	AE 436/23 23,0 cm/9"

AE 438/14 14,0 cm/5 <sup>1/2</sup> "	AE 438/18 18,0 cm/7"	AE 438/20 20,0 cm/8"	AE 438/23 23,0 cm/9"

EUFRATE PASQUÉ



MICROVASCULAR

extrem fein  
 extremely delicate  
 muy fino  
 très fin  
 molto fino

AA  
AB  
AC  
AD  
AE  
AF  
AK  
AL  
AM  
AO  
AP  
AR  
KA  
KD  
KU  
KY



**AE** NAHT SUTURE SUTURA SUTURE SUTURA

Nadelhalter mit Hartmetalleinsätzen  
 Needle Holders with Tungsten Carbide Inserts  
 Porta-agujas con bocas de carburo de Tungsteno  
 Porte-aiguilles à mors en carbure de tungstène  
 Portaghi con placche di carburo di tungsteno



**CARROLL**  
 AE 440/15  
 15,0 cm/6"

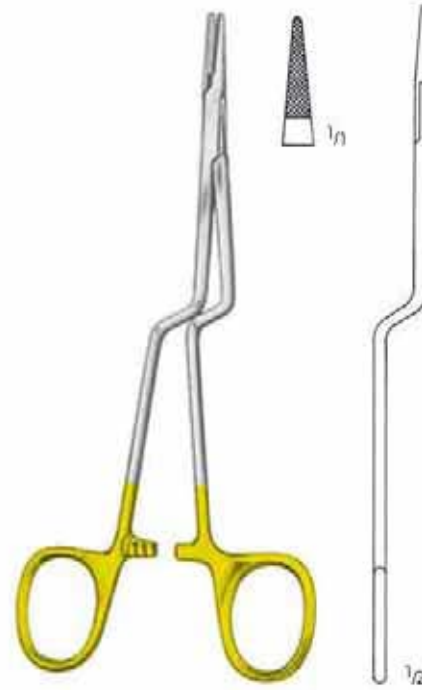

**JACOBSON**  
 AE 444/18  
 18,0 cm/7"



**NEW ORLEANS**  
 AE 446/18  
 18,0 cm/7"



**SENNING**  
 (SWEDISH PATTERN)



AE 448/15  
 15,0 cm/6"



AE 448/17  
 17,0 cm/6<sup>3</sup>/<sub>4</sub>"

NAHT SUTURE SUTURA SUTURE SUTURA

Nadelhalter mit Hartmetalleinsätzen  
 Needle Holders with Tungsten Carbide Inserts  
 Porta-agujas con bocas de carburo de Tungsteno  
 Porte-aiguilles à mors en carbure de tungstène  
 Portaghi con placche di carburo di tungsteno



**DERF**  
 AE 450/12  
 12,5 cm/5"



**CONVERSE**  
 AE 452/12  
 12,5 cm/5"

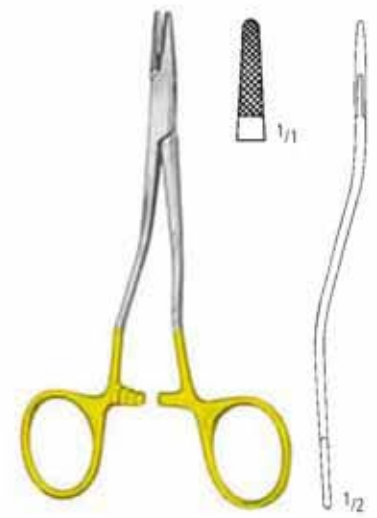

**KILNER**  
 AE 455/13  
 13,5 cm/5 1/4"



**NEIVERT**  
 AE 456/13  
 13,0 cm/5"

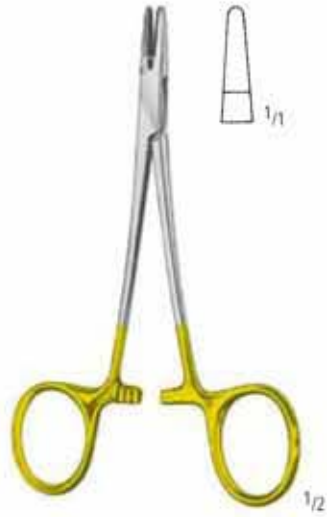

**WEBSTER**  
 AE 460/13  
 13,0 cm/5"

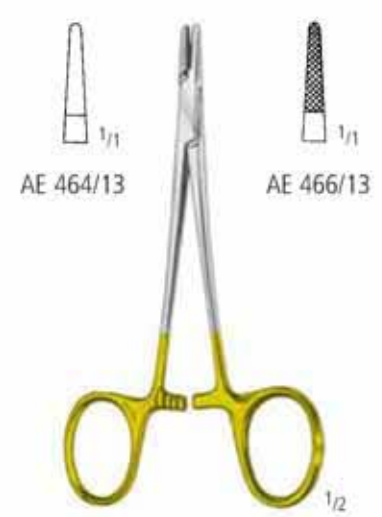

**HALSEY**  
 AE 464/13  
 AE 466/13  
 13,0 cm/5"

AA  
 AB  
 AC  
 AD  
**AE**  
 AF  
 AG  
 AH  
 AI  
 AJ  
 AK  
 AL  
 AM  
 AN  
 AO  
 AP  
 AQ  
 AR  
 AS  
 AT  
 AU  
 AV  
 AW  
 AX  
 AY  
 AZ

**AE** NAHT SUTURE SUTURA SUTURE SUTURA

Nadelhalter mit Hartmetalleinsätzen  
 Needle Holders with Tungsten Carbide Inserts  
 Porta-agujas con bocas de carburo de Tungsteno  
 Porte-aiguilles à mors en carbure de tungstène  
 Portaghi con placche di carburo di tungsteno



**BABY-CRILE-WOOD**  
 AE 468/15  
 15,0 cm/6"



**CRILE-WOOD**  
 AE 469/15  
 15,0 cm/6"



**CRILE-WOOD**  
 AE 470/15  
 15,0 cm/6"



**CRILE-WOOD**



AE 470/18  
 18,0 cm/7"



AE 470/20  
 20,0 cm/8"



AE 470/23  
 23,0 cm/9"



AE 471/18  
 18,0 cm/7"



AE 471/23  
 23,0 cm/9"



AE 471/36  
 36,0 cm/14"

NAHT SUTURE SUTURA SUTURE SUTURA

Nadelhalter mit Hartmetalleinsätzen  
 Needle Holders with Tungsten Carbide Inserts  
 Porta-agujas con bocas de carburo de Tungsteno  
 Porte-aiguilles à mors en carbure de tungstène  
 Portaghi con placche di carburo di tungsteno



**FINOCCHIETTO**  
 AE 472/27  
 27,0 cm/10<sup>3</sup>/<sub>4</sub>"

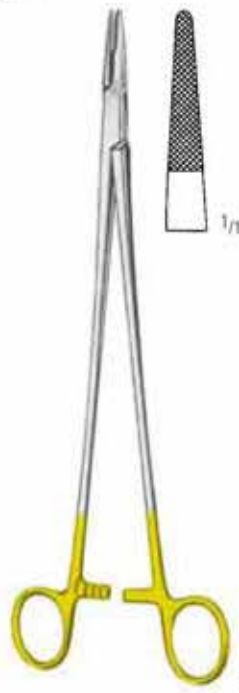

**WANGENSTEEN**  
 AE 474/27  
 27,0 cm/10<sup>3</sup>/<sub>4</sub>"



**BOZEMANN**

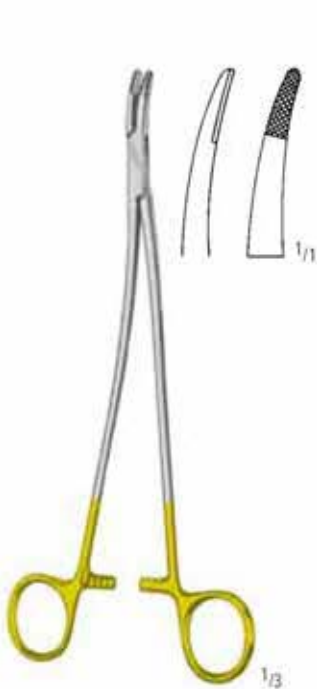
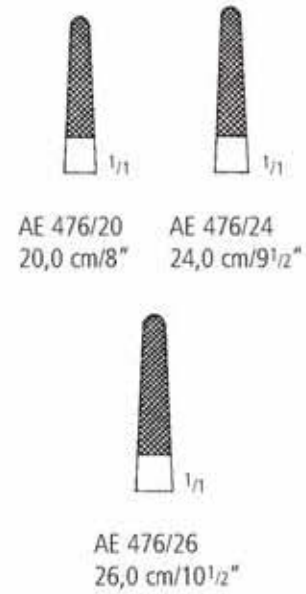

**STRATTE**  
 AE 478/23  
 23,0 cm/9"



**SAROT**

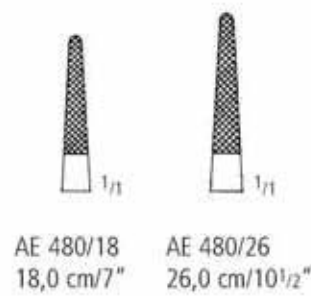

**MASSON**  
 AE 482/27  
 27,0 cm/10<sup>3</sup>/<sub>4</sub>"

AA  
 AB  
 AC  
 AD  
**AE**  
 AF  
 AK  
 AL  
 AM  
 AO  
 AP  
 AR  
 KA  
 KD  
 KU  
 KY

**AE** NAHT SUTURE SUTURA SUTURE SUTURA

Nadelhalter mit Hartmetalleinsätzen  
 Needle Holders with Tungsten Carbide Inserts  
 Porta-agujas con bocas de carburo de Tungsteno  
 Porte-aiguilles à mors en carbure de tungstène  
 Portaghi con placche di carburo di tungsteno

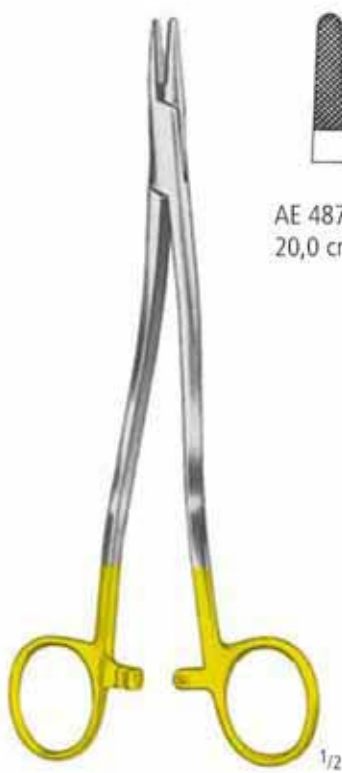

**WERTHEIM**



AE 487/20  
20,0 cm/8"



AE 487/24  
24,0 cm/9 1/2"



AE 487/30  
30,0 cm/12"



**OLSEN-HEGAR**



AE 488/14  
14,0 cm/5 1/2"



AE 488/17  
17,0 cm/6 3/4"



AE 488/19  
19,0 cm/7 1/2"



**OLSEN-HEGAR-USA**

AE 489/16  
16,0 cm/6 1/4"

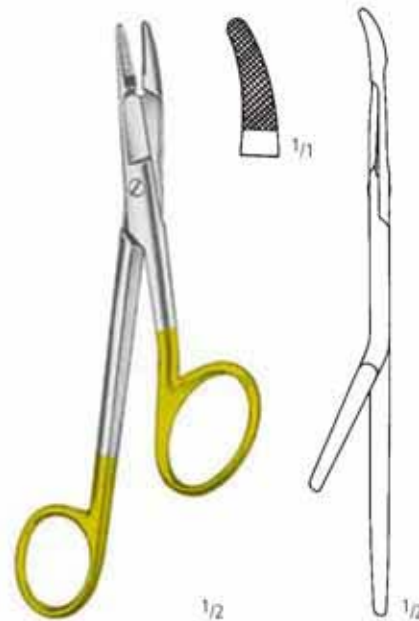

**GILLIES**

AE 490/16  
16,0 cm/6 1/4"





NAHT SUTURE SUTURA SUTURE SUTURA

Nadelhalter mit Hartmetalleinsätzen  
 Needle Holders with Tungsten Carbide Inserts  
 Porta-agujas con bocas de carburo de Tungsteno  
 Porte-aiguilles à mors en carbure de tungstène  
 Portaghi con placche di carburo di tungsteno



MATHIEU



AE 500/14  
14,0 cm/5 1/2"



AE 500/17  
17,0 cm/6 3/4"



AE 500/20  
20,0 cm/8"



AE 500/24  
24,0 cm/9 1/2"



MATHIEU



AE 501/14  
14,0 cm/5 1/2"



MATHIEU



AE 502/17  
17,0 cm/6 3/4"



AE 502/20  
20,0 cm/8"



AE 502/23  
23,0 cm/9"



MATHIEU-DELICATE



AE 504/14  
14,0 cm/5 1/2"



AE 504/17  
17,0 cm/6 3/4"



AE 504/20  
20,0 cm/8"



METZENBAUM



AE 507/17  
17,0 cm/6 3/4"



AE 507/19  
19,5 cm/7 1/2"

AA  
AB  
AC  
AD  
AE  
AF  
AK  
AL  
AM  
AO  
AP  
AR  
KA  
KD  
KU  
KY

**AE** NAHT SUTURE SUTURA SUTURE SUTURA

Nadelhalter mit Hartmetalleinsätzen  
 Needle Holders with Tungsten Carbide Inserts  
 Porta-agujas con bocas de carburo de Tungsteno  
 Porte-aiguilles à mors en carbure de tungstène  
 Portaghi con placche di carburo di tungsteno



**MATHIEU-RYDER**



AE 510/17  
17,0 cm/6<sup>3</sup>/<sub>4</sub>"



AE 510/20  
20,0 cm/8"



AE 510/24  
24,0 cm/9<sup>1</sup>/<sub>2</sub>"



**MATHIEU-RYDER VASCULAR**



AE 512/17  
17,0 cm/6<sup>3</sup>/<sub>4</sub>"



AE 512/20  
20,0 cm/8"



AE 512/24  
24,0 cm/9<sup>1</sup>/<sub>2</sub>"

NAHT SUTURE SUTURA SUTURE SUTURA

Nadelhalter mit Hartmetalleinsätzen  
 Needle Holders with Tungsten Carbide Inserts  
 Porta-agujas con bocas de carburo de Tungsteno  
 Porte-aiguilles à mors en carbure de tungstène  
 Portaghi con placche di carburo di tungsteno

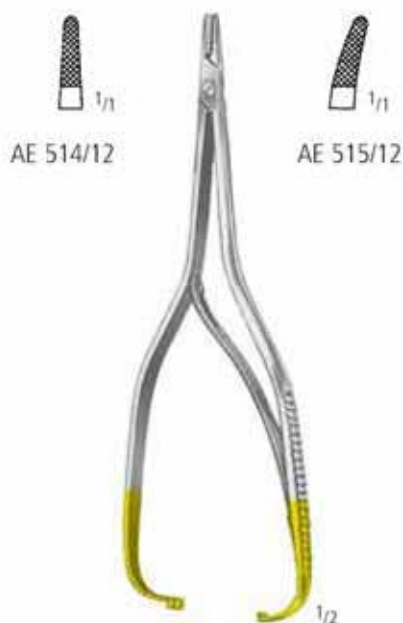

**BOYNTON**  
 12,0 cm/4<sup>3</sup>/<sub>4</sub>"



**ARRUGA**  
 16,0 cm/6<sup>1</sup>/<sub>4</sub>"



**HÖSEL**  
 AE 520/25  
 25,0 cm/10"



**TOENNIS**  
 AE 522/18  
 18,0 cm/7"



**LICHTENBERG**  
 AE 524/20  
 20,0 cm/8"

AA  
 AB  
 AC  
 AD  
**AE**  
 AF  
 AK  
 AL  
 AM  
 AO  
 AP  
 AR  
 KA  
 KD  
 KU  
 KY

**AE** NAHT SUTURE SUTURA SUTURE SUTURA

Nadelhalter mit Hartmetalleinsätzen  
 Needle Holders with Tungsten Carbide Inserts  
 Porta-agujas con bocas de carburo de Tungsteno  
 Porte-aiguilles à mors en carbure de tungstène  
 Portaghi con placche di carburo di tungsteno



**ZWEIFEL**



AE 530/20  
20,0 cm/8"



AE 530/23  
23,0 cm/9"

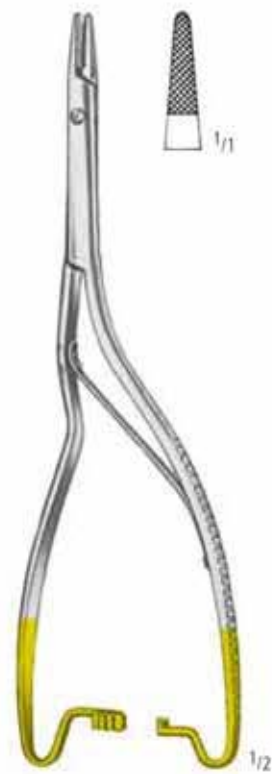

**LUETHY-BECK**  
 AE 535/20  
 20,0 cm/8"

**LANGENBECK**

**LANGENBECK-DELICATE**

**LANGENBECK-RYDER**



AE 540/16  
16,0 cm/6 1/4"



AE 540/18  
18,0 cm/7"



AE 540/20  
20,0 cm/8"



AE 542/18  
18,0 cm/7"



AE 542/20  
20,0 cm/8"



AE 542/23  
23,0 cm/9"



AE 544/18  
18,0 cm/7"



AE 544/20  
20,0 cm/8"



AE 544/23  
23,0 cm/9"

NAHT SUTURE SUTURA SUTURE SUTURA

Drahtzangen mit Hartmetalleinsätzen  
 Wire Twisting Forceps with Tungsten Carbide Inserts  
 Pinzas para torcer hilos con bocas de carburo de Tungsteno  
 Pincas à torsader le fil à mors en carbure de tungstène  
 Pinze per ritorcere fili con placche di carburo di tungsteno



nopa  
TUC®

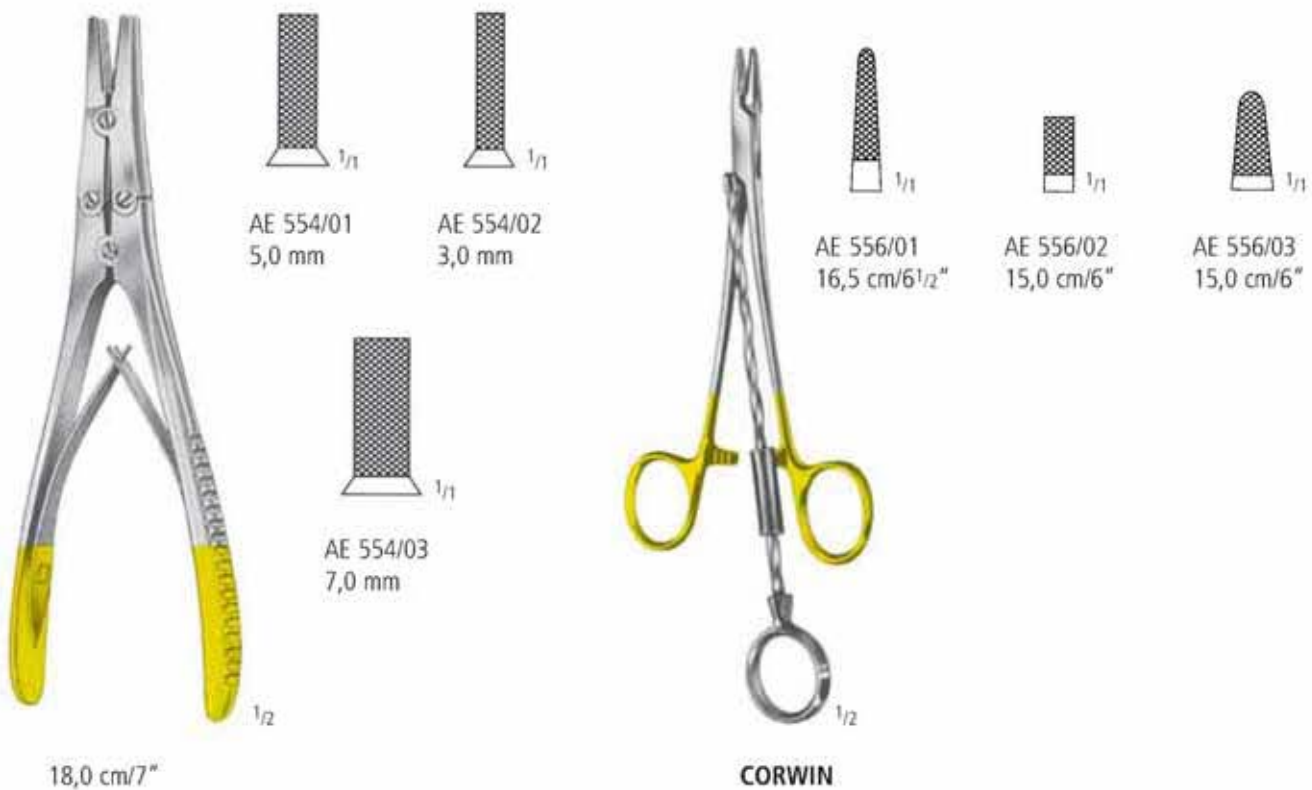

AA  
AB  
AC  
AD  
AE  
AF  
AG  
AH  
AI  
AJ  
AK  
AL  
AM  
AN  
AO  
AP  
AQ  
AR  
AS  
AT  
AU  
AV  
AW  
AX  
AY  
AZ



**AE** NAHT SUTURE SUTURA SUTURE SUTURA

Mikro-Nadelhalter mit Hartmetalleinsätzen  
 Micro-Needle Holders with Tungsten Carbide Inserts  
 Micro-Porta-agujas con bocas de carburo de Tungsteno  
 Micro-Porte-aiguilles à mors en carbure de tungstène  
 Micro-Portaghi con placche di carburo di tungsteno



**CASTROVIEJO**  
 14,0 cm/5 1/2"

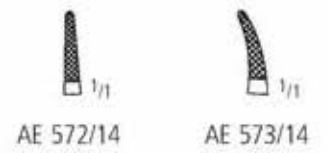

**CASTROVIEJO**  
 14,0 cm/5 1/2"

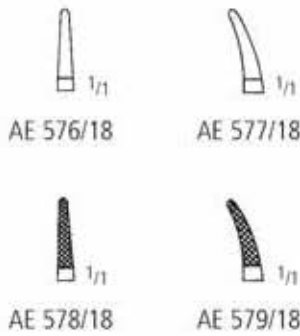

18,0 cm/7"



**JACOBSON**  
 21,0 cm/8 1/4"

NAHT SUTURE SUTURA SUTURE SUTURA

Mikro-Nadelhalter mit Hartmetalleinsätzen  
 Micro-Needle Holders with Tungsten Carbide Inserts  
 Micro-Porta-agujas con bocas de carburo de Tungsteno  
 Micro-Porte-aiguilles à mors en carbure de tungstène  
 Micro-Portaghi con placche di carburo di tungsteno



DIETRICH



AE 582/16  
16,0 cm/6 1/4"



AE 582/18  
18,0 cm/7"



AE 582/20  
20,0 cm/8"



AE 582/23  
23,0 cm/9"



AE 582/26  
26,0 cm/10 1/2"



KALT  
AE 584/14  
13,5 cm/5 1/4"



CASTROVIEJO  
AE 586/13  
13,0 cm/5"



POTTS-SMITH  
AE 588/22  
22,0 cm/8 3/4"

AA  
AB  
AC  
AD  
AE  
AF  
AK  
AL  
AM  
AO  
AP  
AR  
KA  
KD  
KU  
KY

**AE** NAHT SUTURE SUTURA SUTURE SUTURA

Mikro-Nadelhalter mit Rundgriff  
 Micro-Needle Holders with Pen-Type Handle  
 Micro-Porta-agujas con mango redondo  
 Micro-Porte-aiguilles à manches rondes  
 Micro-Portaghi con manici rotondi



**BARRAQUER-  
TROUTMAN**  
 AE 600/10  
 10,0 cm/4"



**BARRAQUER-  
TROUTMAN**  
 AE 601/10  
 10,0 cm/4"



**BARRAQUER-  
TROUTMAN**  
 AE 602/10  
 10,0 cm/4"



**BARRAQUER-  
TROUTMAN**  
 AE 603/10  
 10,0 cm/4"



**BARRAQUER**  
 AE 605/11  
 11,0 cm/4 1/3"



**BARRAQUER**  
 AE 605/13  
 13,0 cm/5"



**BARRAQUER**  
 AE 605/14  
 14,0 cm/5 1/2"



**BARRAQUER**  
 AE 606/14  
 14,0 cm/5 1/2"



**BARRAQUER**  
 AE 607/14  
 14,0 cm/5 1/2"

NAHT SUTURE SUTURA SUTURE SUTURA

Mikro-Nadelhalter mit Rundgriff  
 Micro-Needle Holders with Pen-Type Handle  
 Micro-Porta-agujas con mango redondo  
 Micro-Porte-aiguilles à manches rondes  
 Micro-Portaghi con manici rotondi

AA  
 AB  
 AC  
 AD  
 AE  
 AF  
 AK  
 AL  
 AM  
 AO  
 AP  
 AR  
 KA  
 KD  
 KU  
 KY



**TROUTMAN**  
 AE 609/01  
 12,0 cm/4<sup>3</sup>/<sub>4</sub>"



**TROUTMAN**  
 AE 609/02  
 12,0 cm/4<sup>3</sup>/<sub>4</sub>"



AE 610/15



AE 611/15



AE 612/15



AE 613/15

**AE** NAHT SUTURE SUTURA SUTURE SUTURA

Mikro-Nadelhalter mit Rundgriff  
 Micro-Needle Holders with Pen-Type Handle  
 Micro-Porta-agujas con mango redondo  
 Micro-Porte-aiguilles à manches rondes  
 Micro-Portaghi con manici rotondi



AE 621/14  
 14,0 cm/5 1/2"



AE 623/14  
 14,0 cm/5 1/2"

...für Rechtshänder  
 ...for right handed surgeons  
 ...para diestros  
 ...pour des droitiers  
 ...per destrimanì

Maulteil konkav/konvex  
 Jaws concave/convex  
 Bocas concavas/convexas  
 Mors concave/convexe  
 Morso concavo/convesso



AE 625/14  
 14,0 cm/5 1/2"

...für Linkshänder  
 ...for left handed surgeons  
 ...para zurdos  
 ...pour gaucher  
 ...per manini



NAHT SUTURE SUTURA SUTURE SUTURA

Mikro-Nadelhalter mit Rundgriff  
 Micro-Needle Holders with Pen-Type Handle  
 Micro-Porta-agujas con mango redondo  
 Micro-Porte-aiguilles à manches rondes  
 Micro-Portaghi con manici rotondi



AE 630/18  
 18,0 cm/7"



AE 631/18  
 18,0 cm/7"



AE 632/18  
 18,0 cm/7"



AE 633/18  
 18,0 cm/7"

AA  
 AB  
 AC  
 AD  
**AE**  
 AF  
 AK  
 AL  
 AM  
 AO  
 AP  
 AR  
 KA  
 KD  
 KU  
 KY

**AE** NAHT SUTURE SUTURA SUTURE SUTURA

Mikro-Nadelhalter  
 Micro-Needle Holders  
 Micro-Porta-agujas  
 Micro-Porte-aiguilles  
 Micro-Portaghi

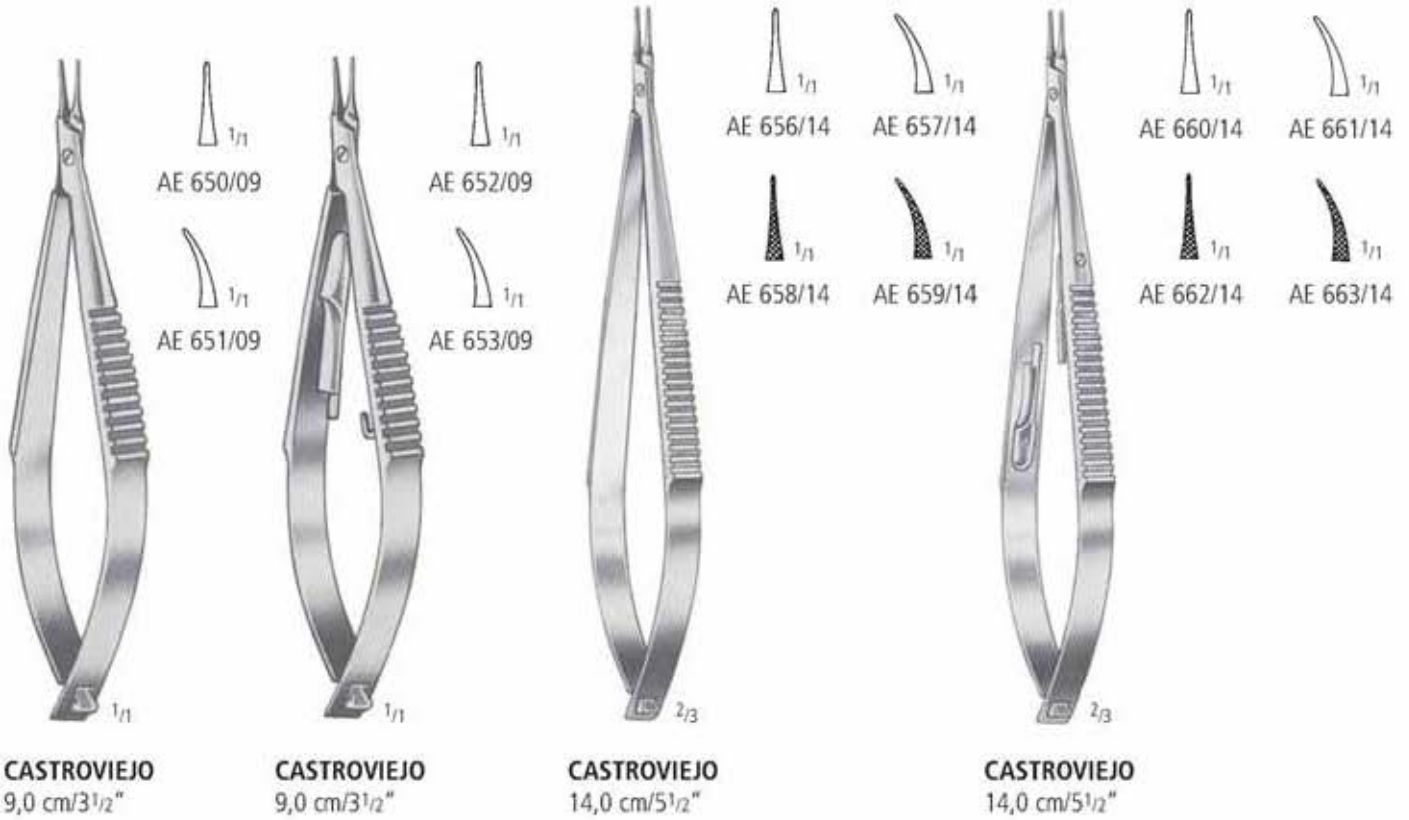

**CASTROVIEJO**  
 9,0 cm/3 1/2"

**CASTROVIEJO**  
 9,0 cm/3 1/2"

**CASTROVIEJO**  
 14,0 cm/5 1/2"

**CASTROVIEJO**  
 14,0 cm/5 1/2"

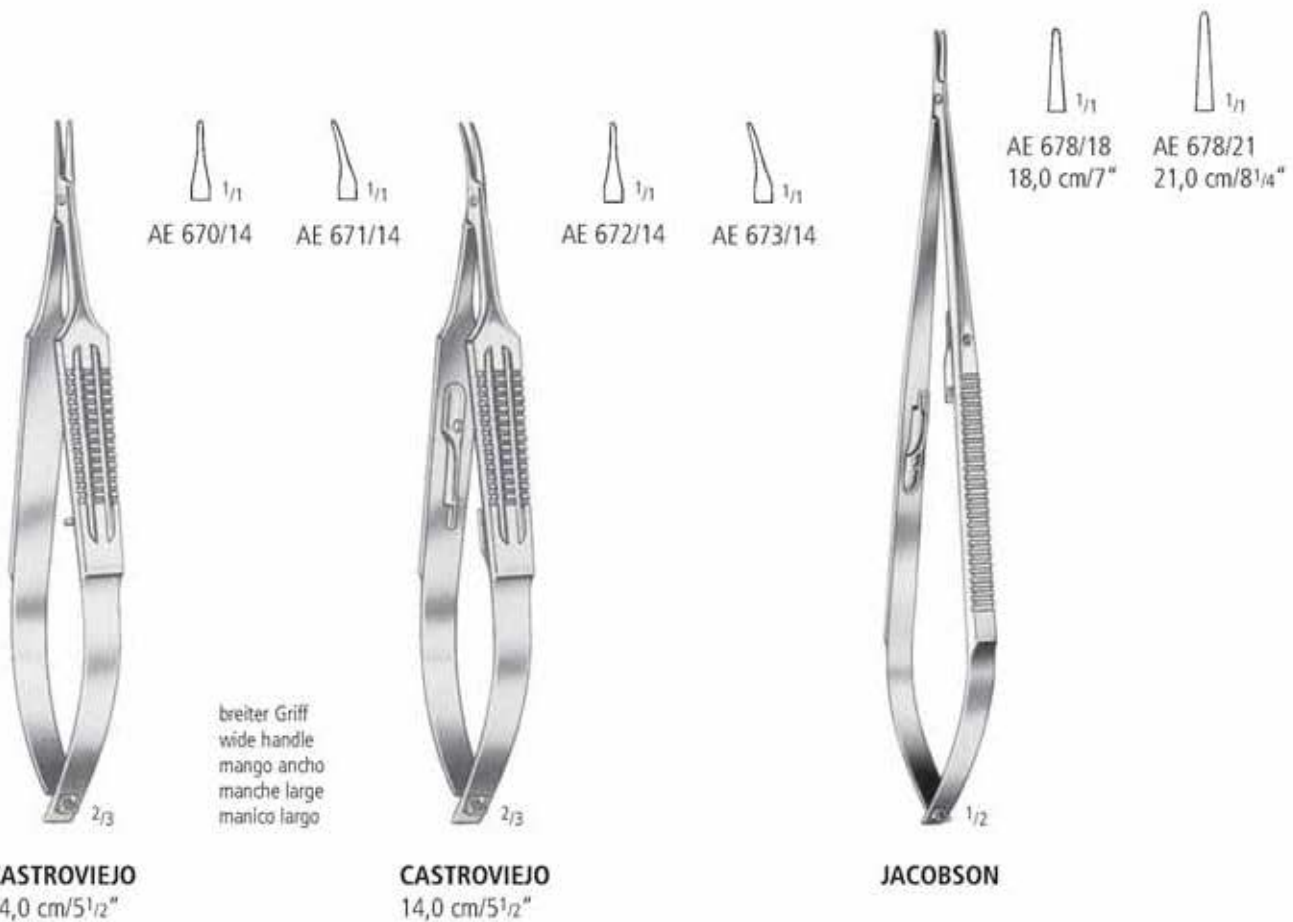

**CASTROVIEJO**  
 14,0 cm/5 1/2"

**CASTROVIEJO**  
 14,0 cm/5 1/2"

**JACOBSON**

breiter Griff  
 wide handle  
 mango ancho  
 manche large  
 manico largo

NAHT SUTURE SUTURA SUTURE SUTURA

Mikro-Nadelhalter  
 Micro-Needle Holders  
 Micro-Porta-agujas  
 Micro-Porte-aiguilles  
 Micro-Portaghi



AE 680/16  
 AE 680/18  
 AE 680/20  
 AE 680/22

16,5 cm/6<sup>1</sup>/<sub>2</sub>"  
 18,0 cm/7"  
 20,0 cm/8"  
 22,0 cm/8<sup>3</sup>/<sub>4</sub>"



AE 681/16  
 AE 681/18  
 AE 681/20  
 AE 681/22

AA

AB

AC

AD

**AE**

AF

AK

AL

AM

AO

AP

AR

KA

KD

KU

KY

**AE** NAHT SUTURE SUTURA SUTURE SUTURA

Mikro-Nadelhalter  
 Micro-Needle-Holders  
 Micro-Porta-agujas  
 Micro-Porte-aiguilles  
 Micro-Portaghi



**PATON**  
 AE 684/11  
 11,0 cm/4<sup>1</sup>/<sub>3</sub>"



**PATON**  
 AE 685/11  
 11,0 cm/4<sup>1</sup>/<sub>3</sub>"



AE 686/14

AE 687/14

**ARRUGA**  
 14,0 cm/5<sup>1</sup>/<sub>2</sub>"



**KALT**  
 AE 688/14  
 14,0 cm/5<sup>1</sup>/<sub>2</sub>"



**KALT-ARRUGA**  
 AE 689/14  
 14,0 cm/5<sup>1</sup>/<sub>2</sub>"



**CASTROVIEJO-KALT**  
 AE 690/14  
 13,5 cm/5<sup>1</sup>/<sub>4</sub>"



**STEVENS**  
 AE 692/13  
 13,0 cm/5"  
 AE 692/15  
 15,0 cm/6"



**POTTS-SMITH**  
 AE 694/22  
 22,0 cm/8<sup>3</sup>/<sub>4</sub>"

NAHT SUTURE SUTURA SUTURE SUTURA

Mikro-Nadelhalter  
 Micro-Needle Holders  
 Micro-Porta-agujas  
 Micro-Porte-aiguilles  
 Micro-Portaghi

AA  
 AB  
 AC  
 AD  
 AE  
 AF  
 AK  
 AL  
 AM  
 AO  
 AP  
 AR  
 KA  
 KD  
 KU  
 KY



AE 696/01

AE 696/02



AE 697/01

AE 697/02



AE 698/01

AE 698/02



AE 699/01

AE 699/02

**CASTROVIEJO**  
 13,0 cm/5"

**CASTROVIEJO**  
 13,0 cm/5"

**CASTROVIEJO**  
 13,0 cm/5"

**CASTROVIEJO**  
 13,0 cm/5"

Griff 8 mm Ø  
 Handle 8 mm Ø  
 Mango 8 mm Ø  
 Manche 8 mm Ø  
 Manico 8 mm Ø

Griff 10 mm Ø  
 Handle 10 mm Ø  
 Mango 10 mm Ø  
 Manche 10 mm Ø  
 Manico 10 mm Ø



**AE** NAHT SUTURE SUTURA SUTURE SUTURA

Reverdin-Nadeln  
 Reverdin Needles  
 Agujas de Reverdin  
 Aiguilles de Reverdin  
 Aghi di Reverdin



**REVERDIN**  
 14,0 cm/5 1/2"



Fig. 1  
 AE 700/01



2  
 AE 700/02



3  
 AE 700/03



4  
 AE 700/04



**REVERDIN**  
 19,5 cm/7 3/4"  
 22,5 cm/9"



Fig. 1  
 AE 701/01  
 AE 702/01



2  
 AE 701/02  
 AE 702/02



3  
 AE 701/03  
 AE 702/03



4  
 AE 701/04  
 AE 702/04

NAHT SUTURE SUTURA SUTURE SUTURA

Unterbindungsnadeln  
Ligature Needles  
Agujas para ligaduras  
Aiguilles à ligatures  
Aghi per legatura

DESCHAMPS

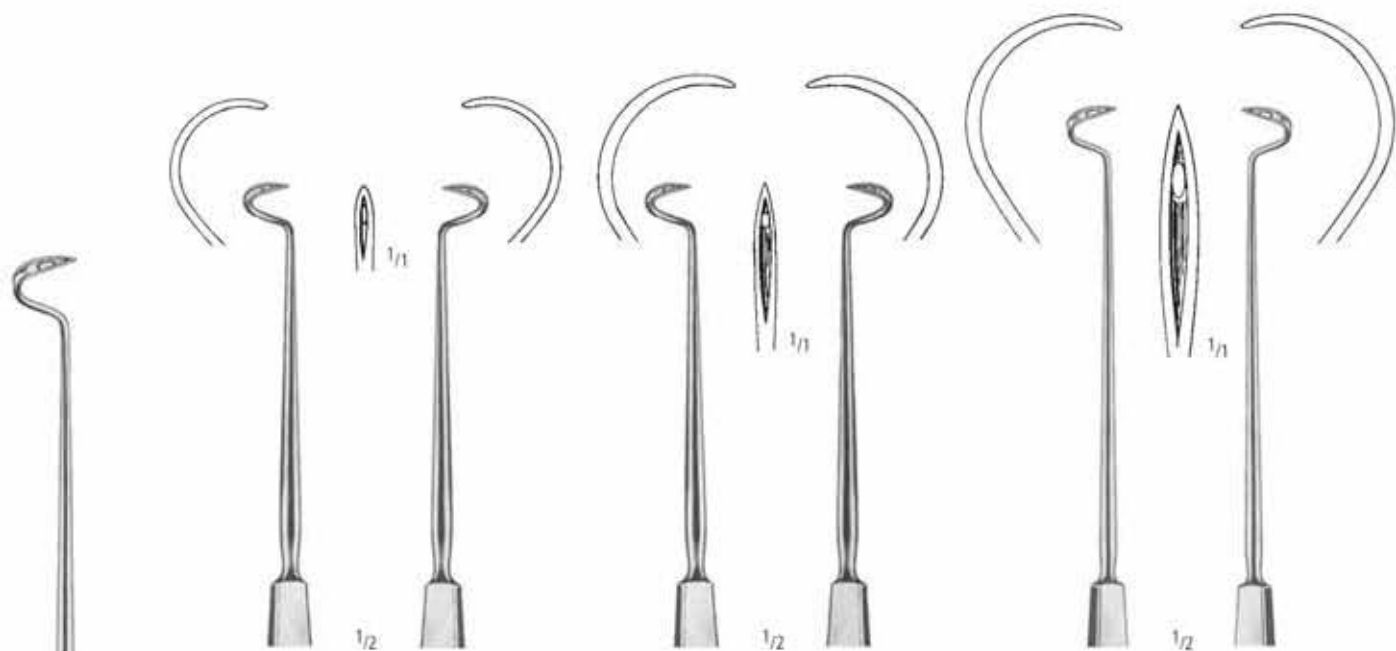

spitz • pointed • agudas • pointues • acuta

20,0 cm/8"	AE 720/20	AE 721/20	AE 722/20	AE 723/20		
21,0 cm/8 <sup>1</sup> / <sub>4</sub> "					AE 724/21	AE 725/21
27,0 cm/10 <sup>3</sup> / <sub>4</sub> "					AE 724/27	AE 725/27

DESCHAMPS

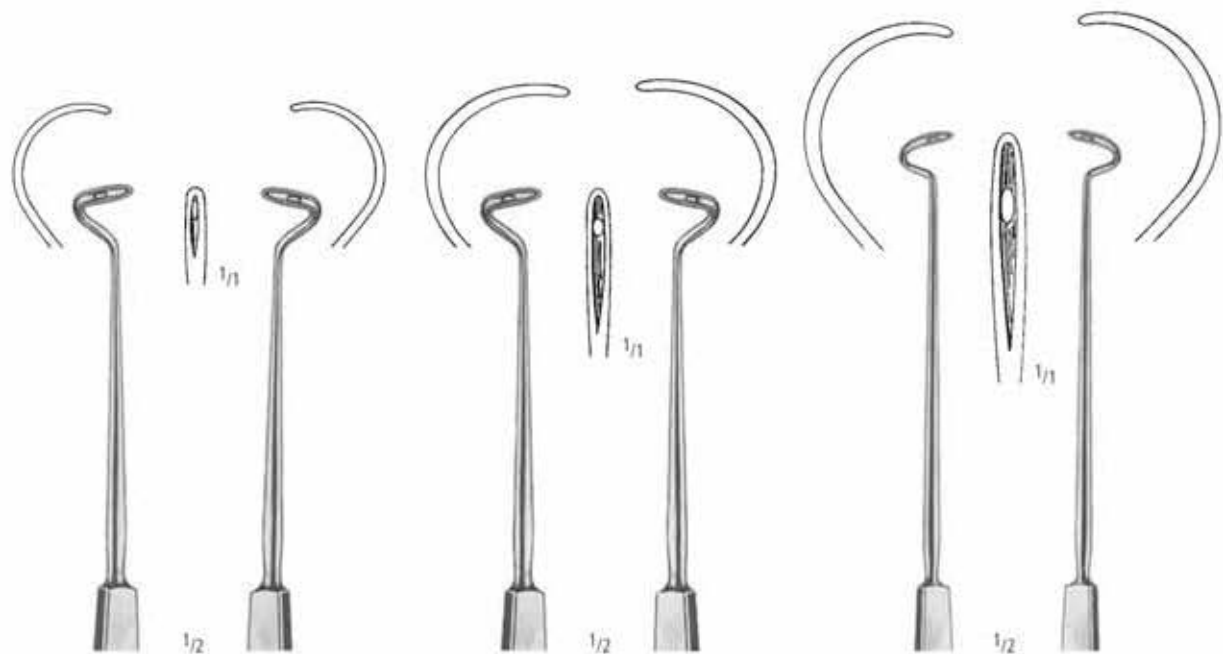

stumpf • blunt • romas • mousses • smussa

20,0 cm/8"	AE 728/20	AE 729/20	AE 730/20	AE 731/20		
21,0 cm/8 <sup>1</sup> / <sub>4</sub> "					AE 732/21	AE 733/21
27,0 cm/10 <sup>3</sup> / <sub>4</sub> "					AE 732/27	AE 733/27

AA  
AB  
AC  
AD  
AE  
AF  
AK  
AL  
AM  
AO  
AP  
AR  
KA  
KD  
KU  
KY

**AE** NAHT SUTURE SUTURA SUTURE SUTURA

Unterbindungsnadeln  
Ligature Needles  
Agujas para ligaduras  
Aiguilles à ligatures  
Aghi per legatura

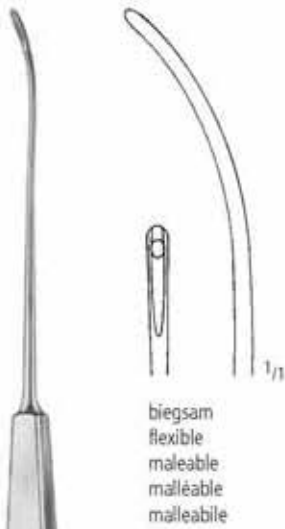

biegsam  
flexible  
maleable  
malleable  
malleabile

AE 750/20  
20,0 cm/8"

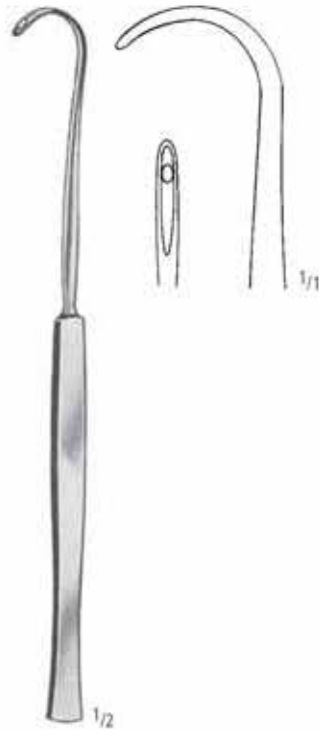

**COOPER**  
AE 751/19  
19,0 cm/7<sup>1</sup>/<sub>2</sub>"



**COOPER**  
AE 751/20  
20,0 cm/8"

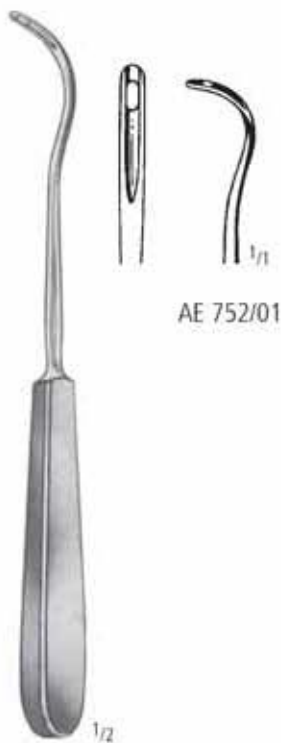

**KOCHER**  
19,0 cm/7<sup>1</sup>/<sub>2</sub>"



AE 752/01

AE 752/02

AE 752/03

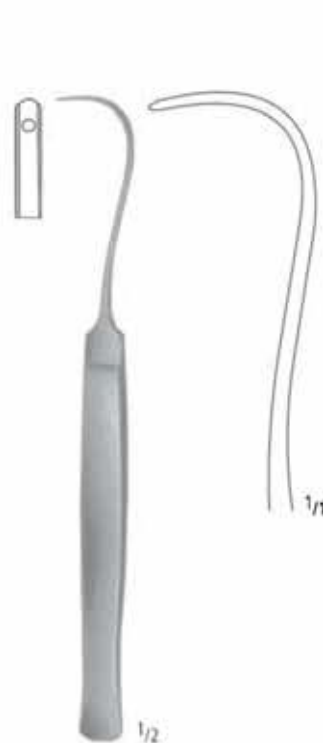

**SYME**  
AE 753/17  
17,0 cm/6<sup>3</sup>/<sub>4</sub>"

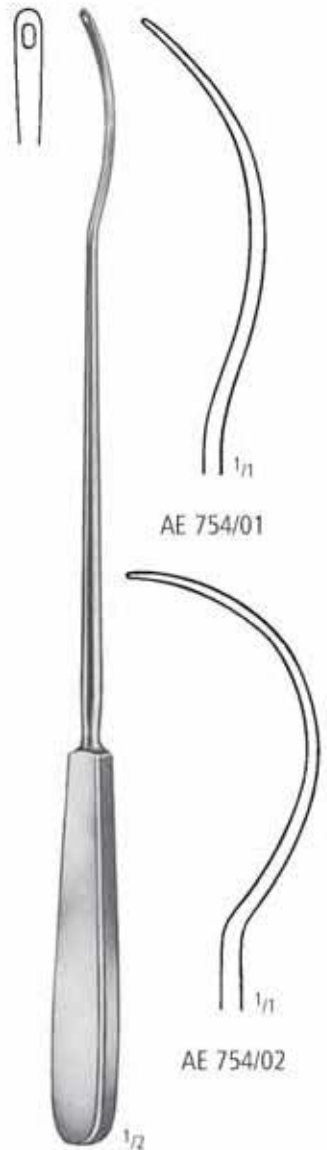

AE 754/01

AE 754/02

**BRUNNER**  
30,0 cm/12"

NAHT SUTURE SUTURA SUTURE SUTURA

Unterbindungsnadeln  
 Ligature Needles  
 Agujas para ligaduras  
 Aiguilles à ligatures  
 Aghi per legatura

AA  
 AB  
 AC  
 AD  
 AE  
 AF  
 AK  
 AL  
 AM  
 AO  
 AP  
 AR  
 KA  
 KD  
 KU  
 KY



**BRUNNER**  
 AE 755/25  
 25,0 cm/10"



**SCHMIEDEN**  
 AE 758/21  
 21,0 cm/8 1/4"



**DE LA ROZA**  
 AE 767/01  
 12,0 cm/4 3/4"



**DE LA ROZA**  
 AE 767/02  
 12,0 cm/4 3/4"



**HESSBERG**  
 AE 768/15  
 15,0 cm/6"



**JACOBI**  
 AE 769/14  
 14,0 cm/5 1/2"

**AE** NAHT SUTURE SUTURA SUTURE SUTURA

Unterbindungsnadeln  
 Ligature Needles  
 Aguja para ligaduras  
 Aiguilles à ligatures  
 Aghi per legatura



**KRONECKER**  
 AE 770/01  
 15,0 cm/6"



**KRONECKER**  
 AE 770/02  
 15,0 cm/6"



**TRÉLAT**  
 AE 772/23  
 23,0 cm/9"



**CLAUS**  
 AE 773/23  
 23,0 cm/9"



**HURD**  
 AE 774/01  
 21,0 cm/8 1/4"



**HURD**  
 AE 774/02  
 21,0 cm/8 1/4"



NAHT SUTURE SUTURA SUTURE SUTURA

Unterbindungsnaedeln  
Ligature Needles  
Agujas para ligaduras  
Aiguilles à ligatures  
Aghi per legatura



AE 775/01



AE 776/01



AE 775/02



AE 776/02



1/2

**ROTTER**  
26,0 cm/10 1/2"



1/2

**ROTTER**  
26,0 cm/10 1/2"



1/11



1/2

**NAGER**  
AE 777/24  
24,0 cm/9 1/2"



1/2

**FALK**  
AE 780/01  
24,0 cm/9 1/2"



1/11



1/2

**FALK**  
AE 780/02  
24,0 cm/9 1/2"



1/11



1/2

**CLAUS-EICKEN**  
AE 781/23  
23,0 cm/9"

AA

AB

AC

AD

**AE**

AF

AK

AL

AM

AO

AP

AR

KA

KD

KU

KY

**AE** NAHT SUTURE SUTURA SUTURE SUTURA

Führungshohlsonden  
 Ligature Conductors  
 Sondas Conductoras  
 Sondes Conductrices  
 Sonda conduttrice



AE 800/01



AE 800/03



AE 800/02



AE 800/04



**BRUNNER**  
 AE 801/25  
 25,0 cm/10"

**BRUNNER**  
 30,0 cm/12"

NAHT SUTURE SUTURA SUTURE SUTURA

Führungshohlsonden  
Ligature Conductors  
Sondas Conductoras  
Sondes Conductrices  
Sonde conductrice



**PAYR**  
AE 802/22  
22,0 cm/8<sup>3</sup>/<sub>4</sub>"



**PAYR**  
AE 803/22  
22,0 cm/8<sup>3</sup>/<sub>4</sub>"

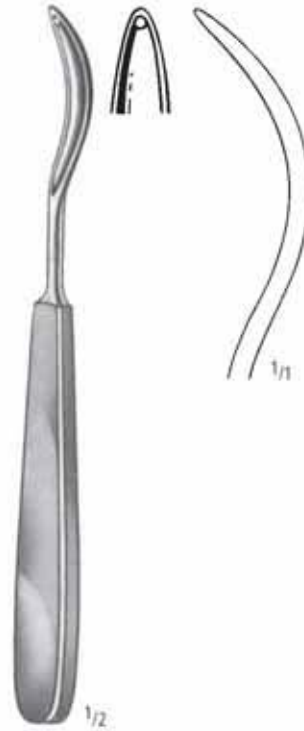

**SCHMIEDEN-PAYR**  
AE 806/19  
19,0 cm/7<sup>1</sup>/<sub>2</sub>"

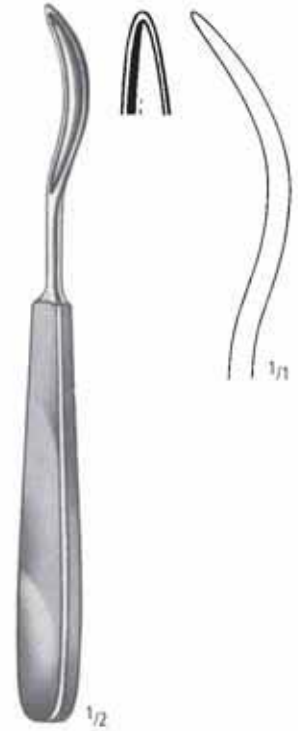

**SCHMIEDEN-PAYR**  
AE 807/19  
19,0 cm/7<sup>1</sup>/<sub>2</sub>"

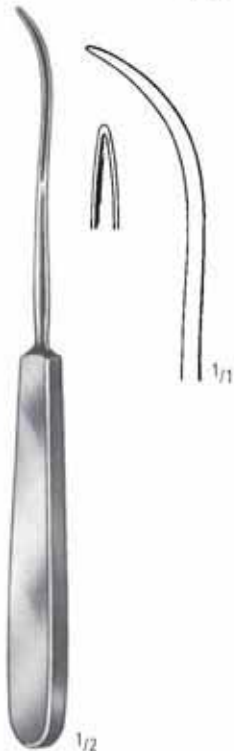

**KÖNIG**  
AE 808/03  
19,5 cm/7<sup>3</sup>/<sub>4</sub>"

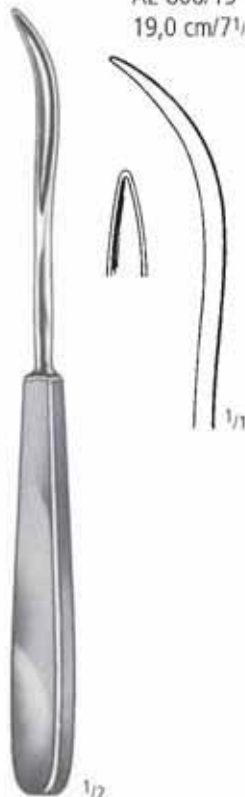

**KÖNIG**  
AE 808/05  
19,5 cm/7<sup>3</sup>/<sub>4</sub>"



**KÖNIG**  
AE 808/07  
19,5 cm/7<sup>3</sup>/<sub>4</sub>"

AA  
AB  
AC  
AD  
**AE**  
AF  
AK  
AL  
AM  
AO  
AP  
AR  
KA  
KD  
KU  
KY

**AE** NAHT SUTURE SUTURA SUTURE SUTURA

Führungshohlsonden  
Ligature Conductors  
Sondas Conductoras  
Sondes Conductrices  
Sonde conduttrice

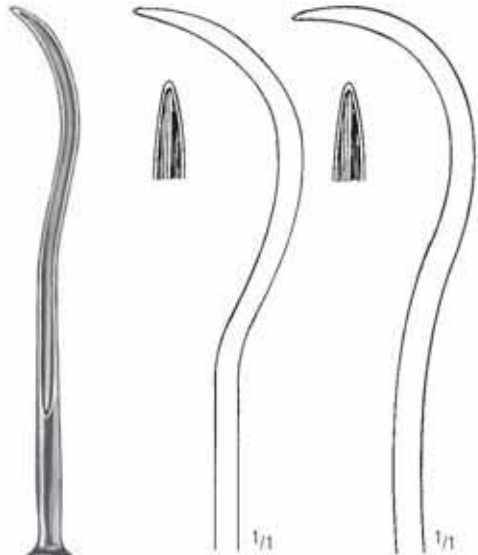

AE 810/25  
25,0 cm/10"  
AE 811/28  
28,0 cm/11"

**KOCHER**

15,0 cm/6"  
16,0 cm/6<sup>1</sup>/<sub>4</sub>"  
18,0 cm/7"  
AE 813/15  
AE 813/16  
AE 814/15  
AE 814/16  
AE 816/18

**KIRSCHNER**



**FERROZELL**  
AE 820/24  
24,0 cm/9<sup>1</sup>/<sub>2</sub>"



**BRUNNER-FERROZELL**  
AE 821/18  
18,0 cm/7"  
AE 821/27  
27,0 cm/10<sup>3</sup>/<sub>4</sub>"



**KIRSCHNER-FERROZELL**  
AE 822/27  
27,0 cm/10<sup>3</sup>/<sub>4</sub>"



**FERROZELL**  
18,0 cm/7"

AE 823/01  
gerade  
straight  
recta  
droite  
retta  
AE 823/02  
gebogen  
curved  
curva  
courbe  
curva

NAHT SUTURE SUTURA SUTURE SUTURA

Fadenknoter, -fänger, -schlingendreher  
 Knot-Tiers, Ligature Catcher, Loop Twisters  
 Tuerce-hilos, Porta-ligaduras  
 Instruments à noeds, Porte-ligature, Tords-fil  
 Strumenti per nodi, Porta-legature, Torcifilo

**Nahtpinzetten und Fadenscheren  
 finden Sie in den Gruppen AB und AC.**

**For Suture Forceps and Ligature Scissors  
 please refer to groups AB and AC.**



AE 830/23  
 23,0 cm/9"



**BOZEMANN**  
 AE 831/21  
 21,0 cm/8<sup>1</sup>/<sub>4</sub>"



**MOD. WIEN**  
 AE 832/23  
 23,5 cm/9<sup>1</sup>/<sub>3</sub>"



**FRIEDRICH**  
 AE 833/16  
 16,0 cm/6<sup>1</sup>/<sub>4</sub>"

AA  
 AB  
 AC  
 AD  
**AE**  
 AF  
 AK  
 AL  
 AM  
 AO  
 AP  
 AR  
 KA  
 KD  
 KU  
 KY



Wundklammerzängchen  
Suture Forceps  
Pinzas para agrafes  
Pincas pour agrafes  
Pinze per agrafes



**MICHEL**  
AE 850/12  
12,0 cm/4<sup>3</sup>/<sub>4</sub>"



**COLLIN**  
AE 852/13  
13,0 cm/5"



**RICHTER-HEATH**  
AE 853/14  
14,0 cm/5<sup>1</sup>/<sub>2</sub>"



**WACHENFELDT**  
AE 855/01  
12,5 cm/5"



**HEGENBARTH**  
AE 856/12  
12,5 cm/5"



**MICHEL**  
AE 858/12  
12,0 cm/4<sup>3</sup>/<sub>4</sub>"

NAHT SUTURE SUTURA SUTURE SUTURA

Wundklammerzängchen, -pinzetten und Wundklammern  
 Suture Forceps and Clips  
 Pinzas para agrafes y agrafes  
 Pincès pour agrafes et agrafes  
 Pinze per agrafes ed agrafes



**LANGE**  
 AE 859/10  
 10,0 cm/4"



**CHILDE**  
 AE 860/01  
 18,0 cm/7"



**CHILDE**  
 AE 860/02  
 18,0 cm/7"

Verkaufseinheit: 1000 Stück  
 Unit for Sale: 1000 each  
 Unidad de venta: 1000 piezas  
 Unité de vente: 1000 pièces  
 Unità di vendita: 1000 pezzi



**MICHEL**

Artikel Nr.	Größen sizes tamaños dimensions dimensioni	mm		
AE 870/08	7,5 x 1,75			
AE 870/11	11 x 2,5			
AE 870/12	12 x 3			
AE 870/14	14 x 3			
AE 870/16	16 x 3			
AE 870/18	18 x 3			
AE 870/20	20 x 3			
AE 870/22	22 x 3			$\frac{1}{2}$

AA  
 AB  
 AC  
 AD  
**AE**  
 AF  
 AK  
 AL  
 AM  
 AO  
 AP  
 AR  
 KA  
 KD  
 KU  
 KY



---

TUPFERZANGEN  
SPONGE FORCEPS  
PINZAS PARA POLIPOS  
PINCES A PANSEMENTS  
PINZE PER POLIPI

AF

nopa<sup>®</sup> instruments



Schwammzangen  
Sponge Holding Forceps  
Pinzas para esponjas  
Pincas à éponges  
Pinze per spugne



**BRYANT**  
AF 040/13  
13,0 cm/5"



**LISTER**  
13,0 cm/5" AF 050/13  
16,0 cm/6 1/4" AF 050/16  
18,0 cm/7" AF 050/18



Korn- und Tupferzangen, Schwammzangen  
 Polypus and Dressing Forceps, Sponge Holding Forceps  
 Pinzas para pólipos, tapones y esponjas  
 Pincas à pansements, à tampons et à éponges  
 Pinze per polipi, tamponi e spugne

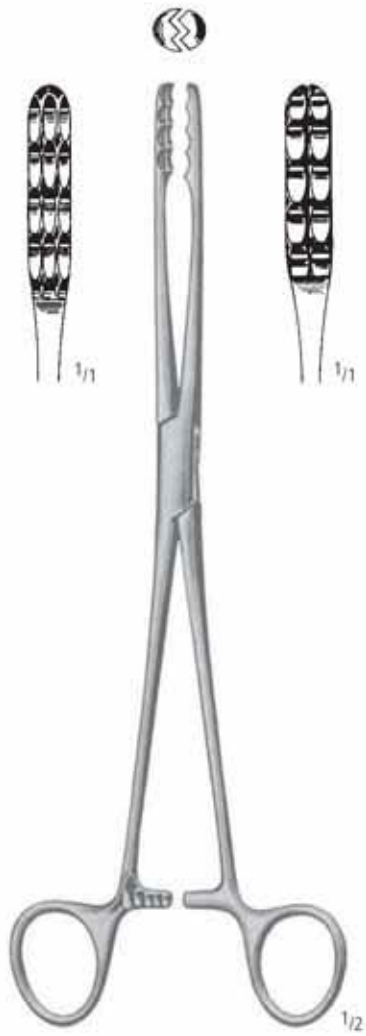

**ULRICH**  
 AF 070/22  
 AF 070/25  
 AF 070/27



22,0 cm/8<sup>3</sup>/<sub>4</sub>"  
 25,0 cm/10"  
 27,0 cm/10<sup>3</sup>/<sub>4</sub>"

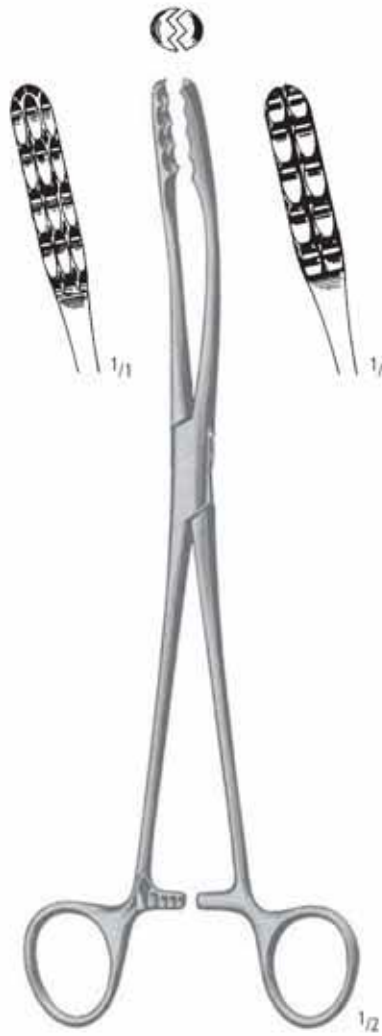

**ULRICH**  
 AF 071/22  
 AF 071/25  
 AF 071/27

Korn- und Tupferzangen, Schwammzangen  
 Polypus and Dressing Forceps, Sponge Holding Forceps  
 Pinzas para pólipos, tapones y esponjas  
 Pincès à pansements, à tampons et à éponges  
 Pinze per polipi, tamponi e spugne



**GROSS-MAIER**

- AF 100/20
- AF 100/22
- AF 100/25
- AF 100/27

- 20,0 cm/8"
- 22,0 cm/8<sup>3</sup>/<sub>4</sub>"
- 25,0 cm/10"
- 27,0 cm/10<sup>3</sup>/<sub>4</sub>"



**GROSS-MAIER**

- AF 101/20
- AF 101/22
- AF 101/25
- AF 101/27

Korn- und Tupferzangen, Schwammzangen  
 Polypus and Dressing Forceps, Sponge Holding Forceps  
 Pinzas para pólipos, tapones y esponjas  
 Pincas à pansements, à tampons et à éponges  
 Pinze per polipi, tamponi e spugne



**GROSS-MAIER**

- AF 102/20
- AF 102/22
- AF 102/25
- AF 102/27

- 20,0 cm/8"
- 22,0 cm/8<sup>3</sup>/<sub>4</sub>"
- 25,0 cm/10"
- 27,0 cm/10<sup>3</sup>/<sub>4</sub>"



**GROSS-MAIER**

- AF 103/20
- AF 103/22
- AF 103/25
- AF 103/27

Korn- und Tupferzangen, Schwammzangen  
 Polypus and Dressing Forceps, Sponge Holding Forceps  
 Pinzas para pólipos, tapones y esponjas  
 Pincers à pansements, à tampons et à éponges  
 Pinze per polipi, tamponi e spugne



**FLETCHER**  
 AF 120/24  
 24,0 cm/9 1/2"



**FLETCHER**  
 AF 123/24  
 24,0 cm/9 1/2"



**WESTERMARK**  
 AF 130/23  
 23,0 cm/9"

Korn- und Tupferzangen, Schwammzangen  
 Polypus and Dressing Forceps, Sponge Holding Forceps  
 Pinzas para pólipos, tapones y esponjas  
 Pincas à pansements, à tampons et à éponges  
 Pinze per polipi, tamponi e spugne



**BOZEMANN**  
 AF 132/26  
 26,0 cm/10<sup>1</sup>/<sub>2</sub>"

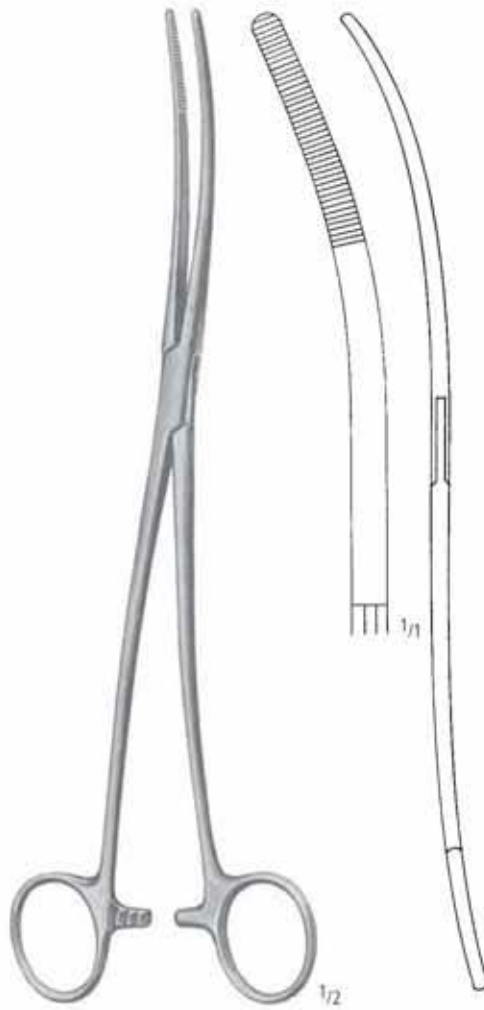

**BOZEMANN**  
 AF 135/26  
 26,0 cm/10<sup>1</sup>/<sub>2</sub>"

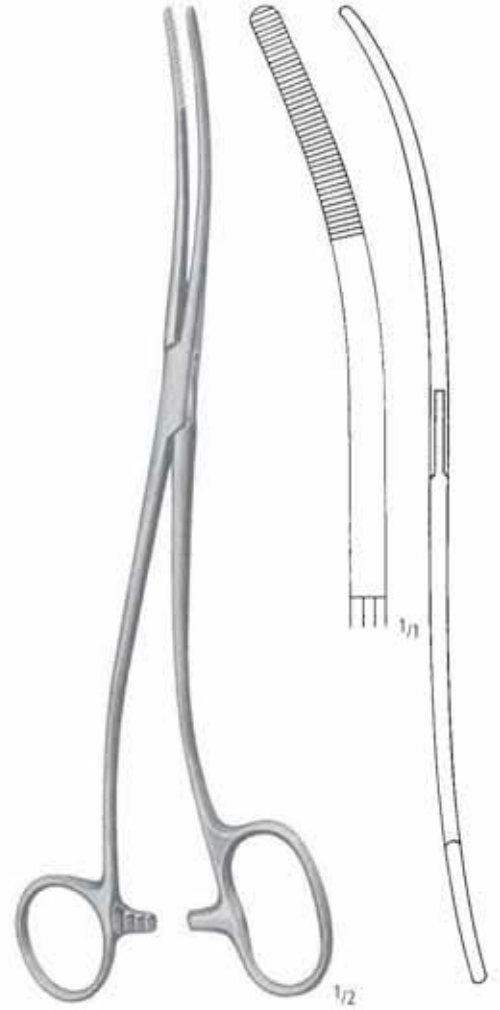

**BOZEMANN-DOUGLAS**  
 AF 137/26  
 26,0 cm/10<sup>1</sup>/<sub>2</sub>"



Korn- und Tupferzangen, Schwammzangen  
 Polypus and Dressing Forceps, Sponge Holding Forceps  
 Pinzas para pólipos, tapones y esponjas  
 Pincas à pansements, à tampons et à éponges  
 Pinze per polipi, tamponi e spugne



**CHERON**  
 AF 141/25  
 25,0 cm/10"



**COLLIN**  
 AF 144/24  
 24,0 cm/9 1/2"



**NOTO**  
 AF 146/28  
 27,5 cm/10 3/4"

Korn- und Tupferzangen, Schwammzangen  
 Polypus and Dressing forceps, Sponge Holding Forceps  
 Pinzas para pólipos, tapones y esponjas  
 Pincès à pansements, à tampons et à éponges  
 Pinze per polipi, lamponi e spugne



**PELKMANN**  
 AF 154/25  
 25,0 cm/10"



**PELKMANN**  
 AF 155/25  
 25,0 cm/10"



**KELLY**  
 AF 161/32  
 32,0 cm/12<sup>3</sup>/<sub>4</sub>"

AA  
 AB  
 AC  
 AD  
 AE  
**AF**  
 AK  
 AL  
 AM  
 AO  
 AP  
 AR  
 KA  
 KD  
 KU  
 KY

Korn- und Tupferzangen, Schwammzangen  
 Polypus and Dressing Forceps, Sponge Holding Forceps  
 Pinzas para pólipos, tapones y esponjas  
 Pincès à pansements, à tampons et à éponges  
 Pinze per polipi, tamponi e spugne

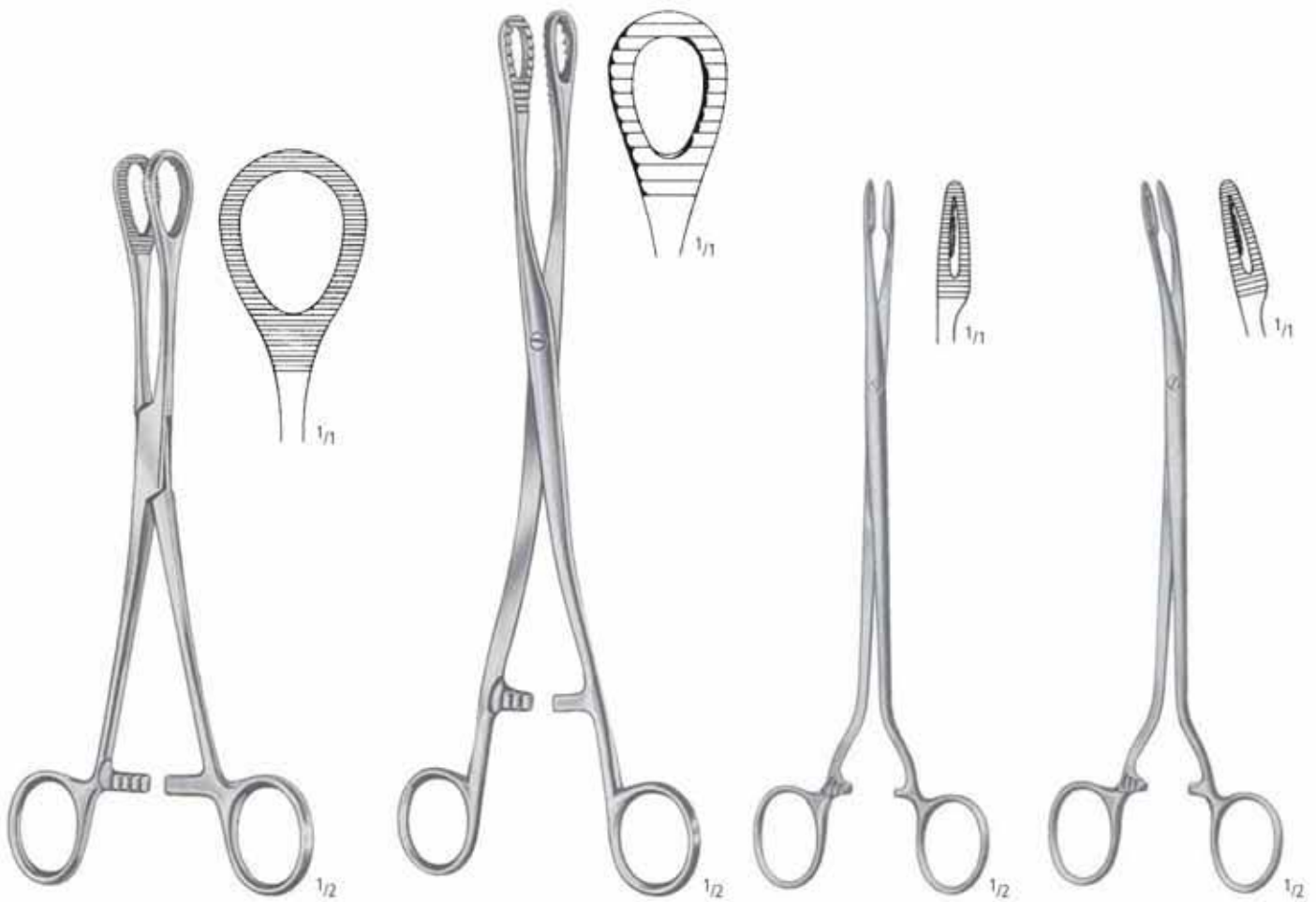

**HEYWOOD-SMITH**

AF 170/21  
 21,0 cm/8<sup>1</sup>/<sub>4</sub>"

**HEYWOOD-SMITH**

AF 172/25  
 25,0 cm/10"

**DUPLAY**

AF 176/20  
 20,5 cm/8"

**DUPLAY**

AF 177/20  
 20,5 cm/8"

TUPFERZANGEN SPONGE FORCEPS PINZAS PARA POLIPOS PINCES A PANSEMENTS PINZE PER POLIPI

Korn- und Tupferzangen, Schwammzangen  
 Polypus and Dressing Forceps, Sponge Holding Forceps  
 Pinzas para pólipos, tapones y esponjas  
 Pincas à pansements, à tampons et à éponges  
 Pinze per polipi, tamponi e spugne



**FOERSTER-BALLENGER**



AF 200/18  
 AF 200/20

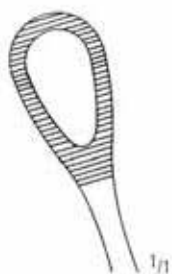

18,0 cm/7"  
 20,0 cm/8" AF 201/18  
 AF 201/20

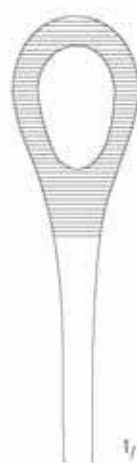

AF 200/36



36,0 cm/14" AF 201/36



AF 202/18  
 AF 202/20



18,0 cm/7"  
 20,0 cm/8" AF 203/18  
 AF 203/20



**FOERSTER-BALLENGER**

25,0 cm/10"



AF 200/25



AF 201/25



AF 202/25



AF 203/25

AA  
 AB  
 AC  
 AD  
 AE  
**AF**  
 AK  
 AL  
 AM  
 AO  
 AP  
 AR  
 KA  
 KD  
 KU  
 KY

Korn- und Tupferzangen, Schwammzangen  
 Polypus and Dressing Forceps, Sponge Holding Forceps  
 Pinzas para pólipos, tapones y esponjas  
 Pincers à pansements, à tampons et à éponges  
 Pinze per polipi, tamponi e spugne



25,0 cm/10"



AF 210/25

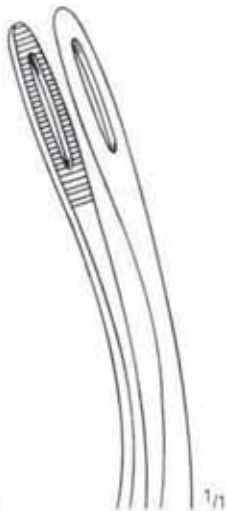

AF 211/25



**RAMPLEY**



AF 216/18  
18,0 cm/7"

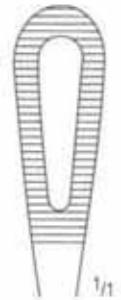

AF 216/25  
25,0 cm/10"



Korn- und Tupferzangen, Schwammzangen  
 Polypus and Dressing Forceps, Sponge Holding Forceps  
 Pinzas para pólipos, tapones y esponjas  
 Pincas à pansements, à tampons et à éponges  
 Pinze per polipi, tamponi e spugne



**SIMS-MAIER**  
 AF 222/28  
 28,0 cm/11"

**SIMS-MAIER**  
 AF 223/28  
 28,0 cm/11"

AF 226/17  
 AF 226/25

**WALTON**  
 17,0 cm/6<sup>3</sup>/<sub>4</sub>"  
 25,5 cm/10"

AF 227/17  
 AF 227/25

AA  
 AB  
 AC  
 AD  
 AE  
**AF**  
 AK  
 AL  
 AM  
 AO  
 AP  
 AR  
 KA  
 KD  
 KU  
 KY



---

WUNDHAKEN  
RETRACTORS  
SEPARADORES  
ECARTEURS  
DIVARICATORI

**AK**

**nopa**<sup>®</sup> instruments



Feine Wundhaken  
 Delicate Hooks  
 Ganchos  
 Crochets très fins  
 Divaricatori sottili



**GILLIES**  
 AK 020/01  
 18,0 cm/7"



**GILLIES**  
 AK 020/02  
 18,0 cm/7"



**KILNER**  
 AK 022/15  
 15,0 cm/6"



**FRAZIER**  
 AK 024/13  
 13,0 cm/5"



AK 026/01



**KLEINERT-KUTZ**  
 AK 026/02  
 16,0 cm/6<sup>1</sup>/<sub>4</sub>"



AK 026/03

WUNDHAKEN RETRACTORS SEPARADORES ECARTEURS DIVARICATORI

Feine Wundhaken  
Delicate Hooks  
Ganchos  
Crochets très fins  
Divaricatori sottili

AA  
AB  
AC  
AD  
AE  
AF  
AK  
AL  
AM  
AO  
AP  
AR  
KA  
KD  
KU  
KY



AK 028/01  
16,0 cm/6 1/4"



AK 028/02  
16,0 cm/6 1/4"



AK 028/03  
16,0 cm/6 1/4"



AK 028/04  
16,0 cm/6 1/4"



**O'CONNOR**  
AK 030/16  
16,0 cm/6 1/4"



**GRAEFE**  
AK 032/01  
16,0 cm/6 1/4"



**GRAEFE**  
AK 032/02  
16,0 cm/6 1/4"



**AK** WUNDHAKEN RETRACTORS SEPARADORES ECARTEURS DIVARICATORI

Feine Wundhaken  
Delicate Hooks  
Ganchos  
Crochets très fins  
Divaricatori sottili



**CUSHING**  
28,0 cm/11"



AK 034/01



AK 034/02



**CUSHING**  
19,0 cm/7<sup>1</sup>/<sub>2</sub>"



AK 036/01



AK 036/02



**MOLDESTAD**  
AK 038/13  
13,0 cm/5"



AK 040/05  
5 mm



AK 040/07  
7 mm

17,0 cm/6<sup>3</sup>/<sub>4</sub>"



AK 042/10  
Ø 1,0 mm



AK 042/12  
Ø 1,2 mm

18,5 cm/7<sup>1</sup>/<sub>3</sub>"



AK 044/11  
11,0 cm/4<sup>1</sup>/<sub>3</sub>"

WUNDHAKEN RETRACTORS SEPARADORES ECARTEURS DIVARICATORI

Feine Wundhaken  
Delicate Hooks  
Ganchos  
Crochets très fins  
Divaricatori sottili



16,0 cm/6 1/4"



AK 050/01



AK 051/01



AK 052/01



AK 050/02



AK 051/02



AK 052/02



AK 050/03



AK 051/03



AK 052/03



AK 050/04



AK 051/04



AK 052/04



16,0 cm/6 1/4"



AK 060/01



AK 062/01



AK 060/02



AK 062/02



AK 060/03



AK 062/03



AK 060/04



AK 062/04

AA  
AB  
AC  
AD  
AE  
AF  
AK  
AL  
AM  
AO  
AP  
AR  
KA  
KD  
KU  
KY

**AK** WUNDHAKEN RETRACTORS SEPARADORES ECARTEURS DIVARICATORI

Feine Wundhaken  
Delicate Hooks  
Ganchos  
Crochets très fins  
Divaricatori sottili

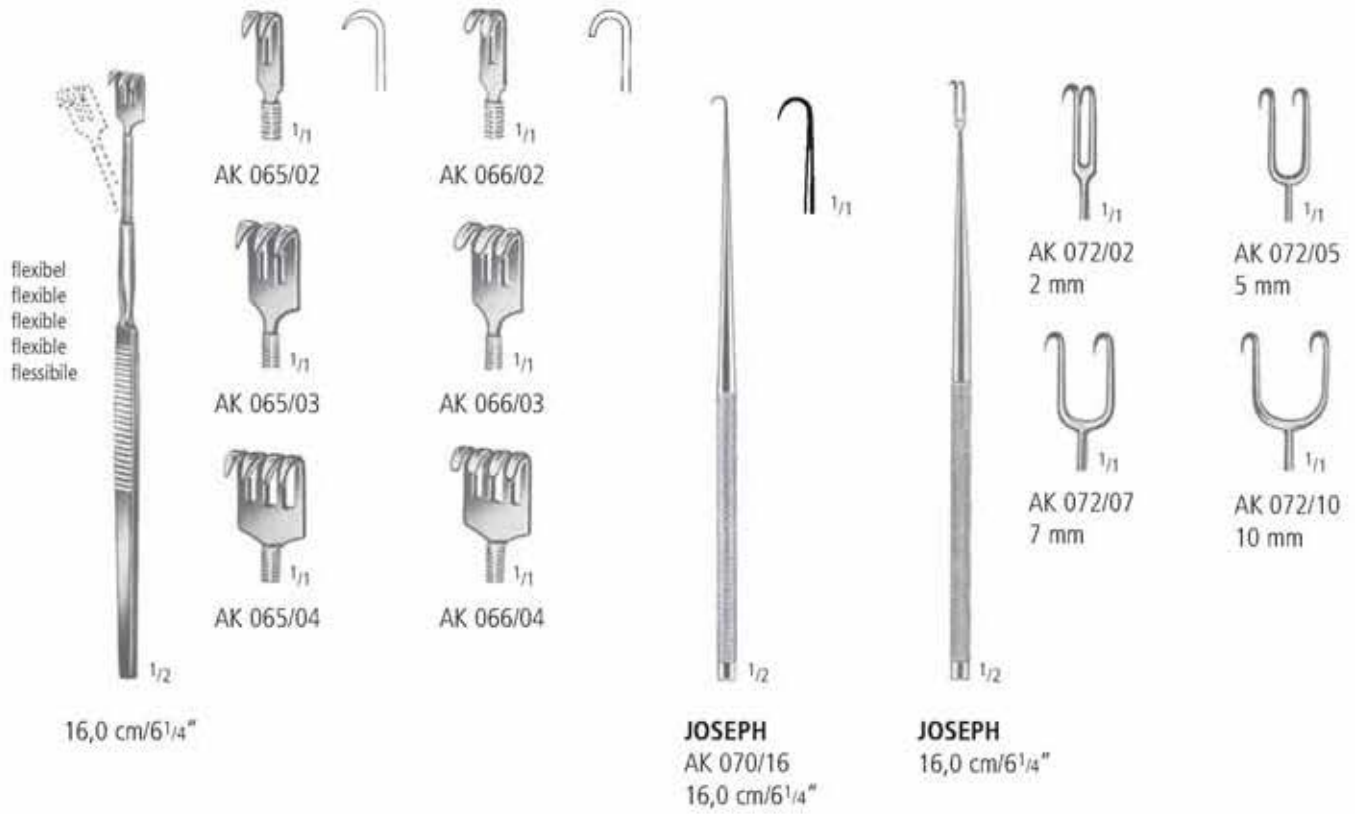

WUNDHAKEN RETRACTORS SEPARADORES ECARTEURS DIVARICATORI

Feine Wundhaken  
Delicate Hooks  
Ganchos  
Crochets très fins  
Divaricatori sottili



**MEYERDING**  
18,0 cm/7"

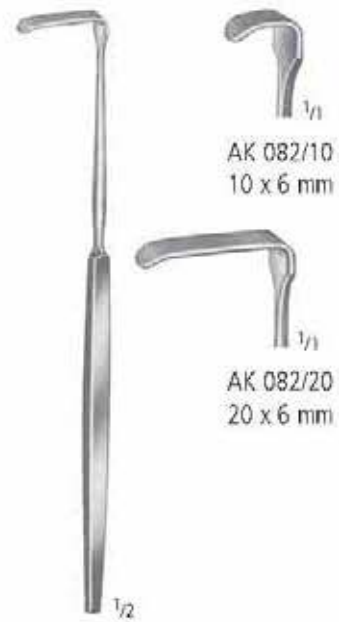

**SENN-GREEN**  
15,0 cm/6"



**MINI-LANGENBECK**  
16,0 cm/6 1/4"



AA  
AB  
AC  
AD  
AE  
AF  
**AK**  
AL  
AM  
AO  
AP  
AR  
KA  
KD  
KU  
KY

**AK** WUNDHAKEN RETRACTORS SEPARADORES ECARTEURS DIVARICATORI

Feine Wundhaken  
Delicate Hooks  
Ganchos  
Crochets très fins  
Divaricatori sottili



**DESMARRES**  
13,0 cm/5"



**DESMARRES**  
16,0 cm/6 1/4"

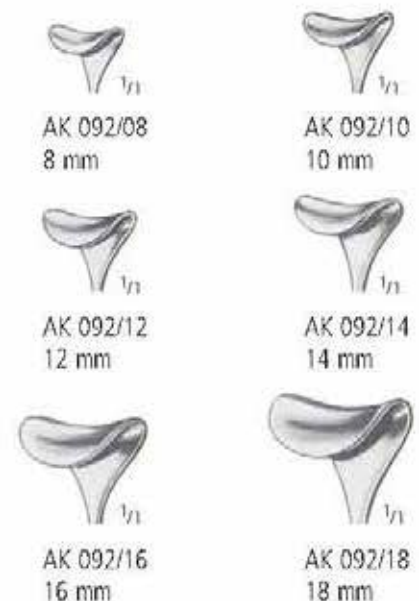

**CUSHING**  
20,0 cm/8"



**CUSHING**  
24,0 cm/9 1/2"

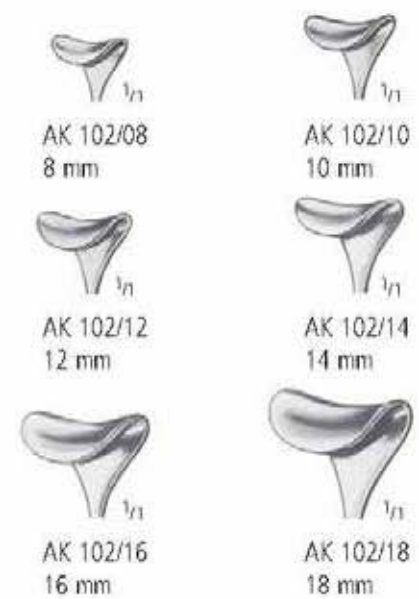



WUNDHAKEN RETRACTORS SEPARADORES ECARTEURS DIVARICATORI

Feine Wundhaken  
Delicate Hooks  
Ganchos  
Crochets très fins  
Divaricatori sottili



AA  
AB  
AC  
AD  
AE  
AF  
**AK**  
AL  
AM  
AO  
AP  
AR  
KA  
KD  
KU  
KY

**AK** WUNDHAKEN RETRACTORS SEPARADORES ECARTEURS DIVARICATORI

Feine Wundhaken, Spinalhaken  
 Delicate Retractors, Spinal Retractors  
 Separadores finas, Separadores espinales  
 Ecarteurs fins, Ecarteurs spinals  
 Divaricatori sottili, Divaricatori spinali

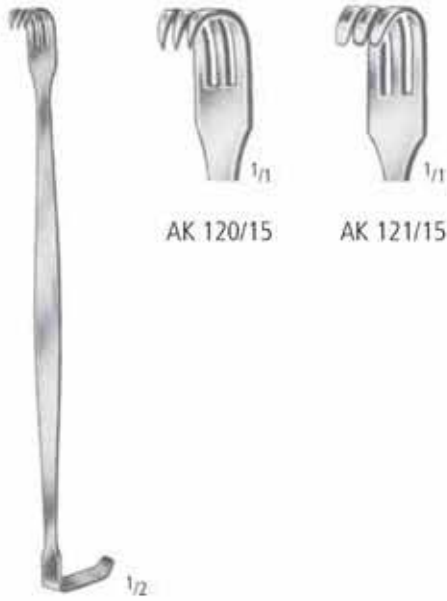

**BABY-SENN-MILLER**  
 15,0 cm/6"

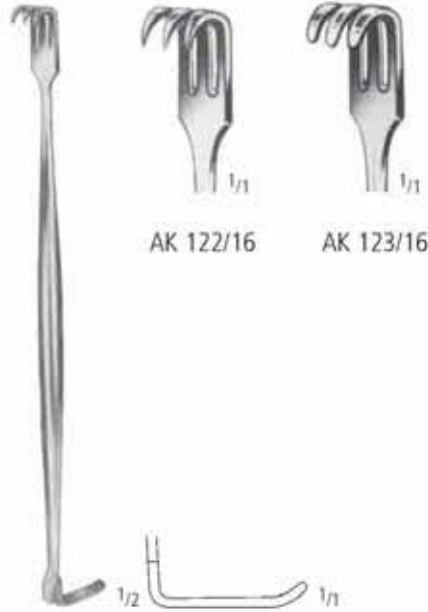

**SENN-MILLER**  
 16,0 cm/6 1/4"



**RAGNELL-DAVIS**  
 AK 125/14  
 14,0 cm/5 1/2"

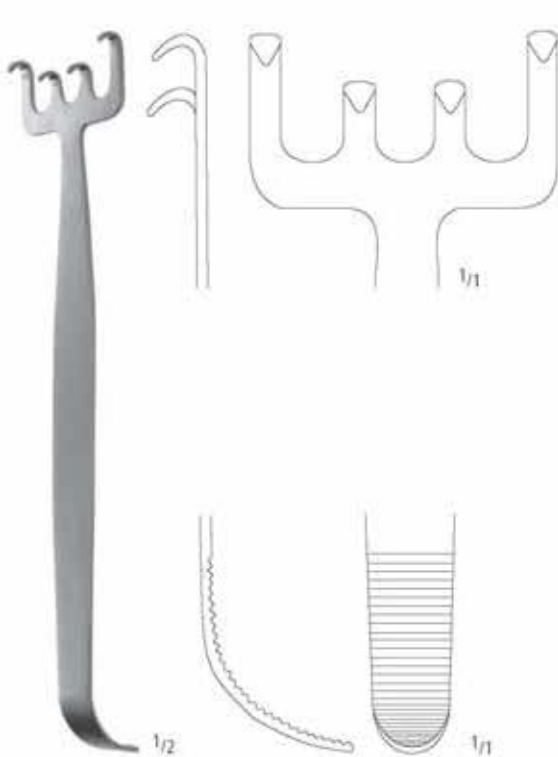

**WALTER**  
 AK 128/19  
 19,0 cm/7 1/2"



**CUSHING**  
 AK 130/20  
 20,0 cm/8"

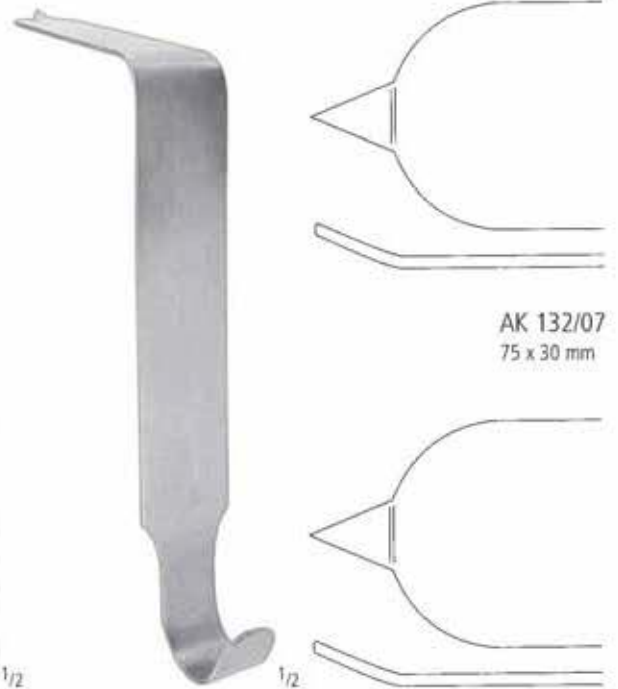

**TAYLOR**  
 16,5 cm/6 1/2"

AK 132/07  
 75 x 30 mm

AK 132/10  
 100 x 30 mm





**VOLKMANN**  
21,5 cm/8 1/2"

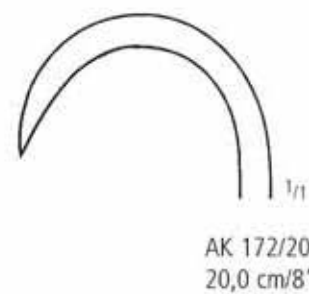

**KOERTE**  
24,0 cm/9 1/2"



**BILLROTH**  
25,0 cm/10"

AA  
AB  
AC  
AD  
AE  
AF  
AK  
AL  
AM  
AO  
AP  
AR  
KA  
KD  
KU  
KY



**OLLIER**  
22,5 cm/9"



**ISRAEL**  
25,0 cm/10"

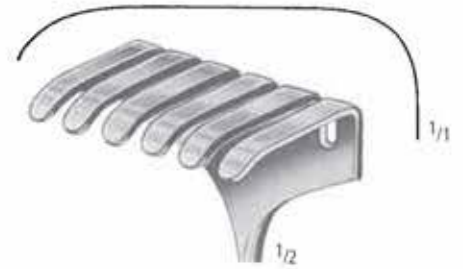





**LANGENBECK**  
21,0 cm/8<sup>1</sup>/<sub>4</sub>"

<sup>1</sup>/<sub>2</sub>

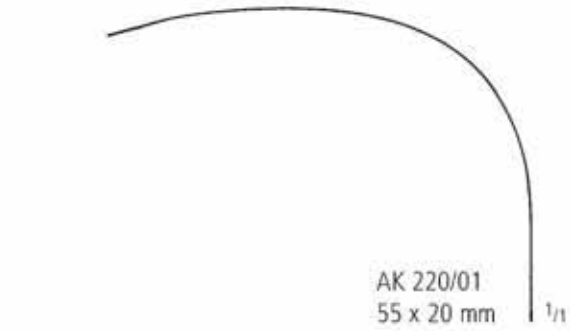

AK 220/01  
55 x 20 mm

<sup>1</sup>/<sub>1</sub>

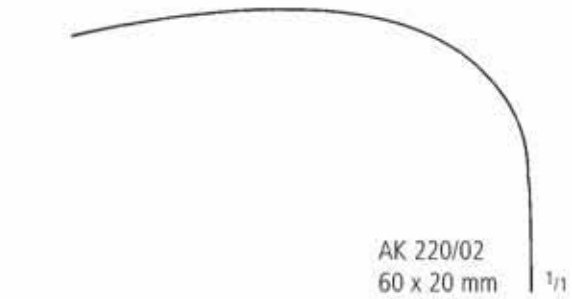

AK 220/02  
60 x 20 mm

<sup>1</sup>/<sub>1</sub>

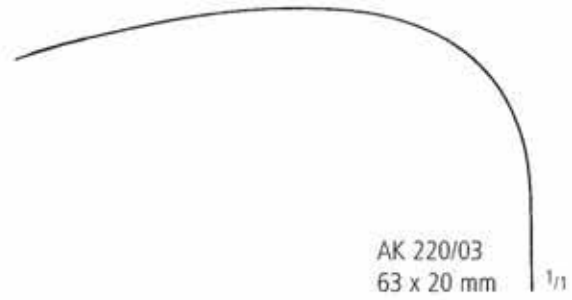

AK 220/03  
63 x 20 mm

<sup>1</sup>/<sub>1</sub>

WUNDHAKEN RETRACTORS SEPARADORES ECARTEURS DIVARICATORI

Weichtelhaken  
Soft tissue retractors  
Separadores para partes blandas  
Ecarteurs pour parties molles  
Divaricatori per tessuti molli



**OBWEGESER**  
24,0 cm/9 1/2"

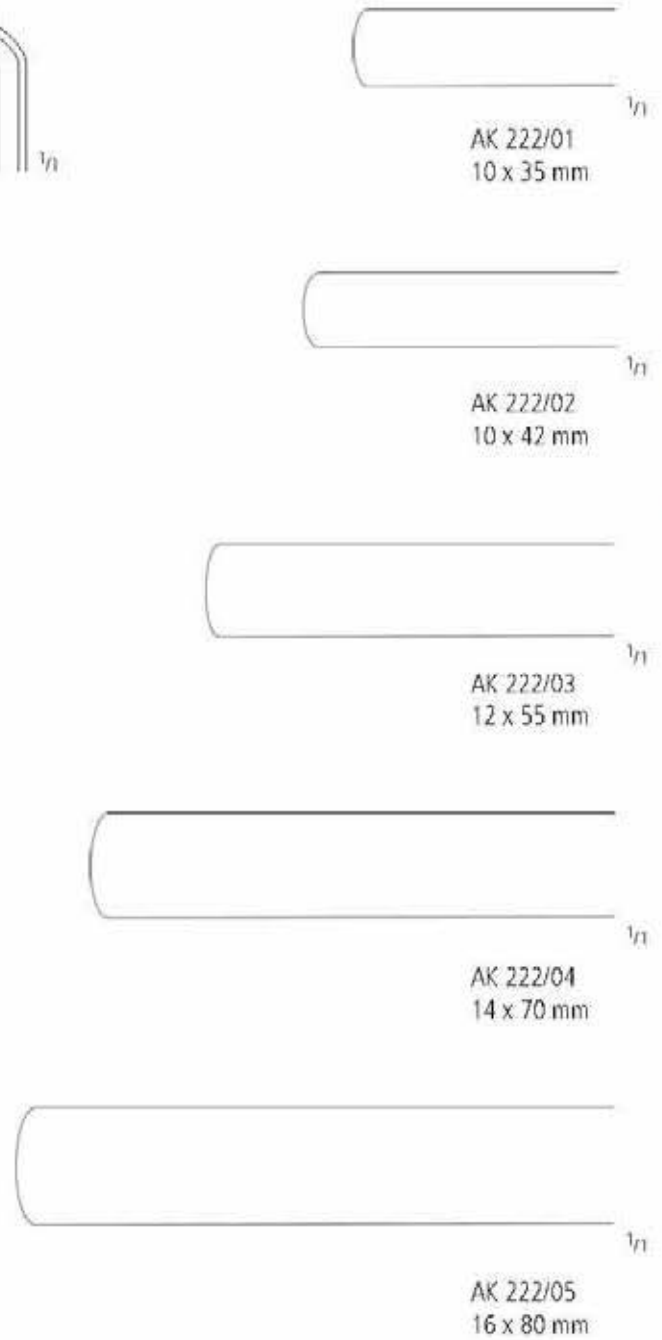

AA  
AB  
AC  
AD  
AE  
AF  
**AK**  
AL  
AM  
AO  
AP  
AR  
KA  
KD  
KU  
KY

**AK** WUNDHAKEN RETRACTORS SEPARADORES ECARTEURS DIVARICATORI

Weichteilhaken  
 Soft tissue retractors  
 Separadores para partes blandas  
 Ecarteurs pour parties molles  
 Divaricatori per tessuti molli



**OBWEGESER**  
 24,0 cm/9<sup>1</sup>/<sub>2</sub>"



AK 223/01  
 5 x 16 mm



AK 223/02  
 7 x 25 mm



AK 223/03  
 10 x 35 mm



AK 223/04  
 10 x 42 mm



AK 223/05  
 12 x 55 mm



AK 223/06  
 14 x 70 mm



AK 223/07  
 16 x 80 mm

WUNDHAKEN RETRACTORS SEPARADORES ECARTEURS DIVARICATORI

Ramushaken  
Ramus retractors  
Separadores para el ramo  
Ecarteurs pour ramus  
Divaricatori per ramo

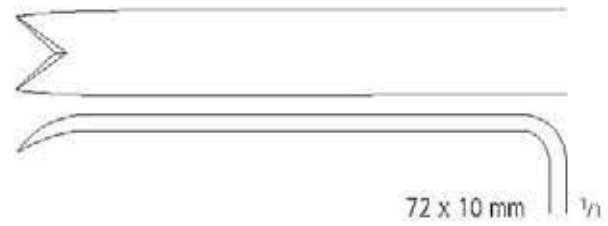
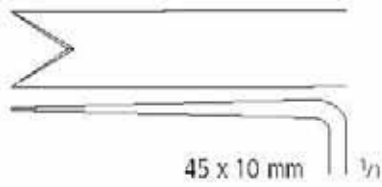

**OBWEGESER**  
AK 225/01  
22,0 cm/8 $\frac{3}{4}$ "



**OBWEGESER**  
AK 225/02  
24,0 cm/9 $\frac{1}{2}$ "

AA  
AB  
AC  
AD  
AE  
AF  
AK  
AL  
AM  
AO  
AP  
AR  
KA  
KD  
KU  
KY



**LANGENBECK**  
AK 230/01-05  
22,0 cm/8<sup>3</sup>/<sub>4</sub>"



AK 230/01  
AK 231/01  
30 x 11 mm



AK 230/02  
AK 231/02  
30 x 14 mm



AK 230/03  
AK 231/03  
30 x 16 mm



AK 230/04  
AK 231/04  
40 x 11 mm



AK 230/05  
AK 231/05  
50 x 11 mm



**LANGENBECK**  
AK 231/01-05  
22,0 cm/8<sup>3</sup>/<sub>4</sub>"



AA  
AB  
AC  
AD  
AE  
AF  
AK  
AL  
AM  
AO  
AP  
AR  
KA  
KD  
KY



**KOCHER-LANGENBECK**  
21,5 cm/8 1/2"



AK 233/01  
25 x 6 mm



AK 233/02  
35 x 8 mm



AK 233/03  
35 x 11 mm



AK 233/04  
35 x 15 mm



AK 233/05  
40 x 11 mm



AK 233/06  
55 x 11 mm



AK 233/07  
70 x 14 mm



AK 233/08  
80 x 12 mm



AK 233/09  
80 x 16 mm

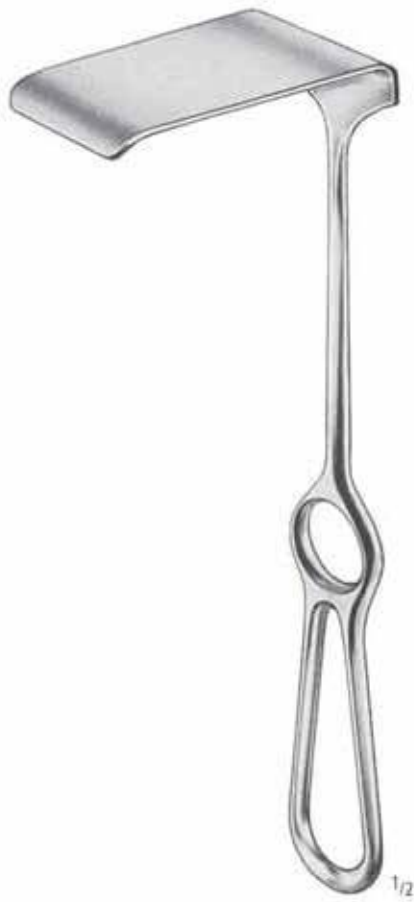

**KOCHER**  
23,0 cm/9"

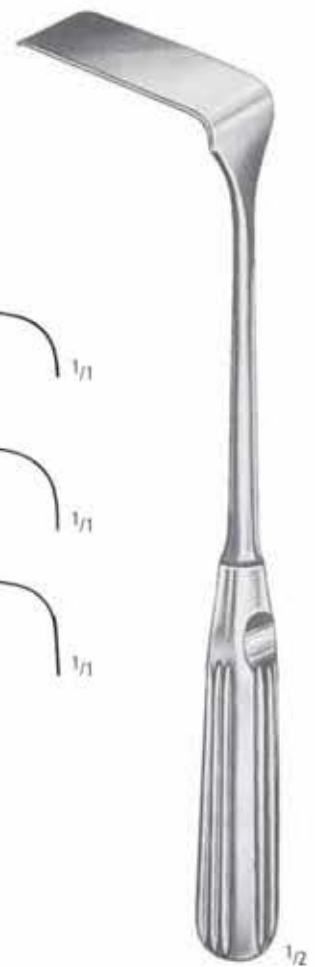
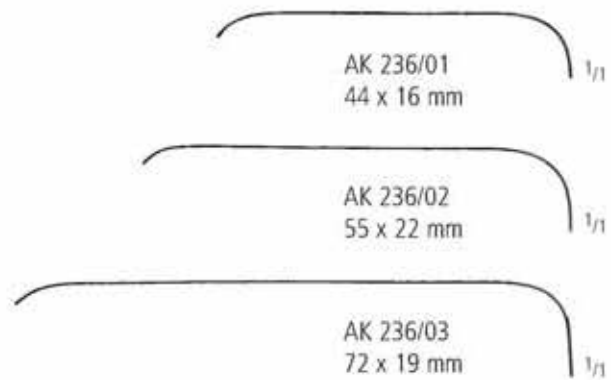
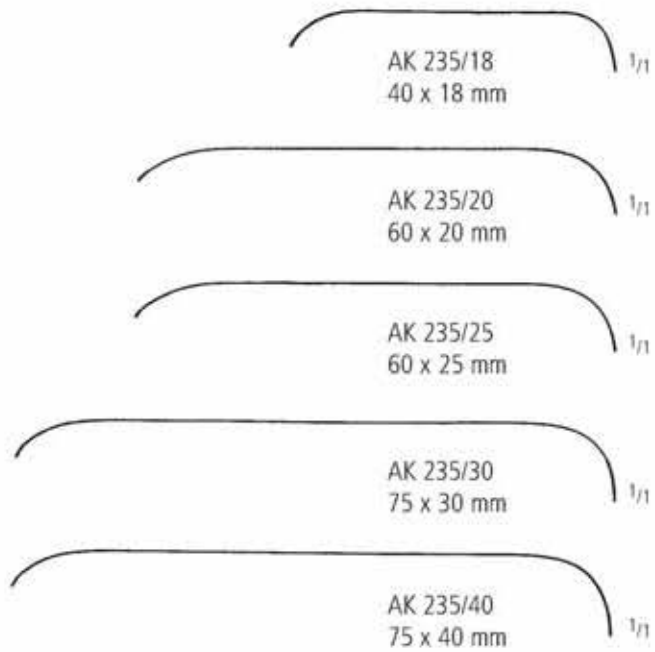

**SAUERBRUCH**  
22,5 cm/8<sup>3</sup>/<sub>4</sub>"



AK 237/01  
50 x 55 mm

**MORRIS**  
26,0 cm/10<sup>1</sup>/<sub>2</sub>"



AK 237/02  
70 x 40 mm

AK 237/03  
70 x 50 mm

AK 237/04  
70 x 65 mm

**MORRIS**  
25 cm/10"



60 x 50 mm

60 x 45 mm

**MORRIS**  
AK 238/24  
25,0 cm/10"

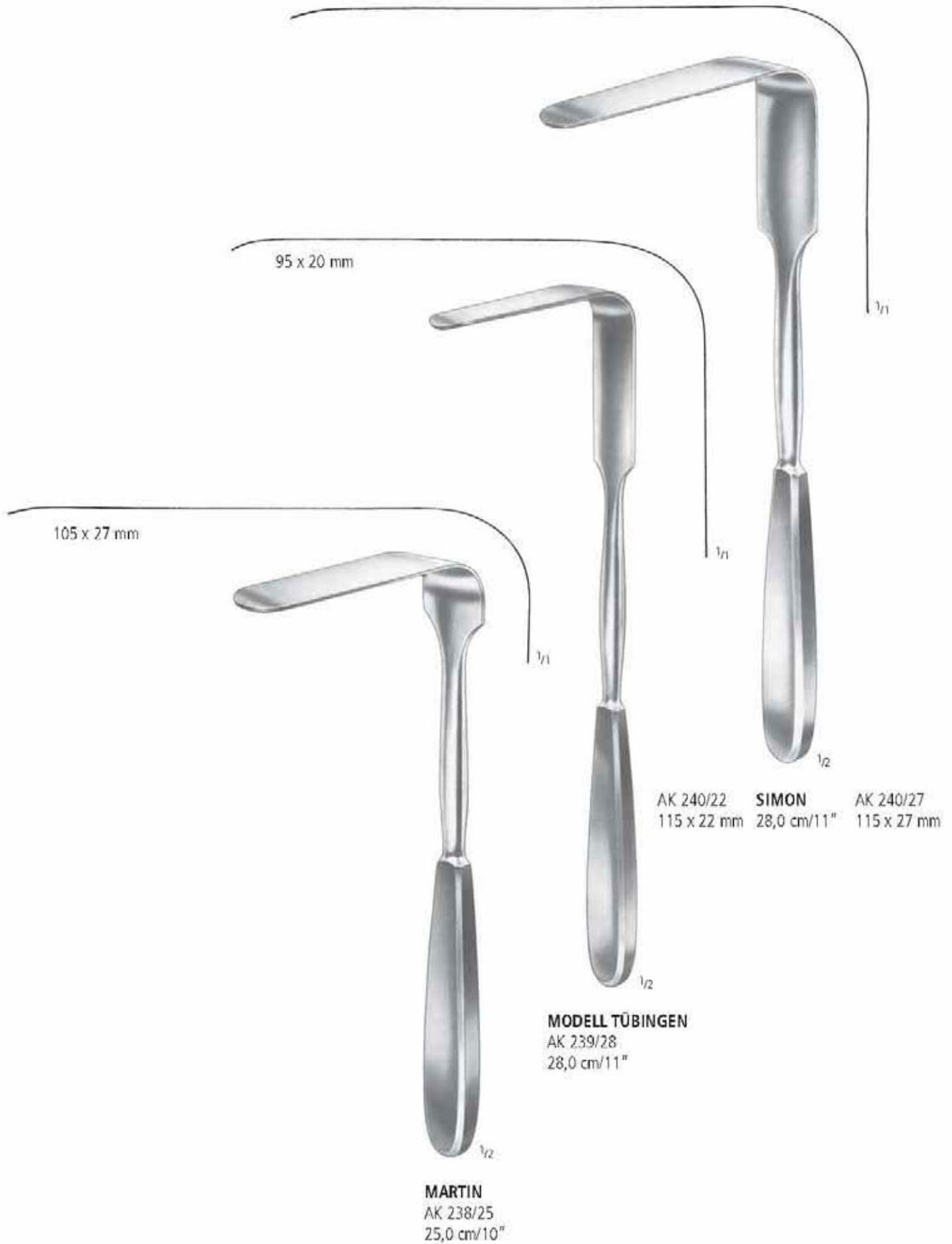

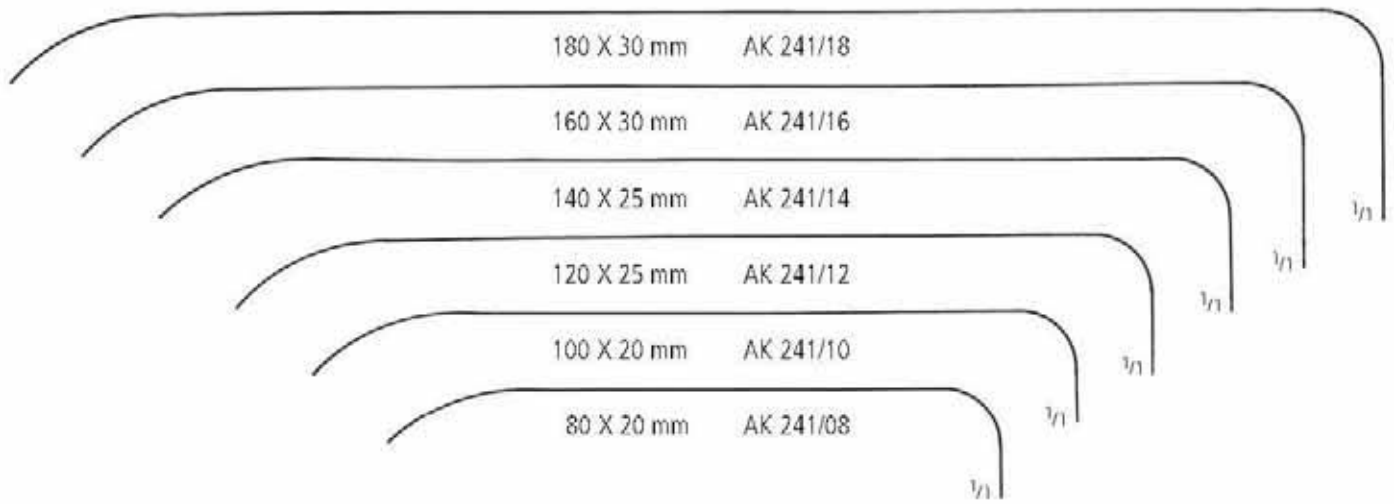

**BRUNNER**  
AK 241/08-18  
25,0 cm/10"



**LAHEY**  
AK 242/19  
19,0 cm/7 1/2"



**LITTLE**  
AK 243/20  
20,0 cm/8"

AA  
AB  
AC  
AD  
AE  
AF  
**AK**  
AL  
AM  
AO  
AP  
AR  
KA  
KD  
KU  
KY

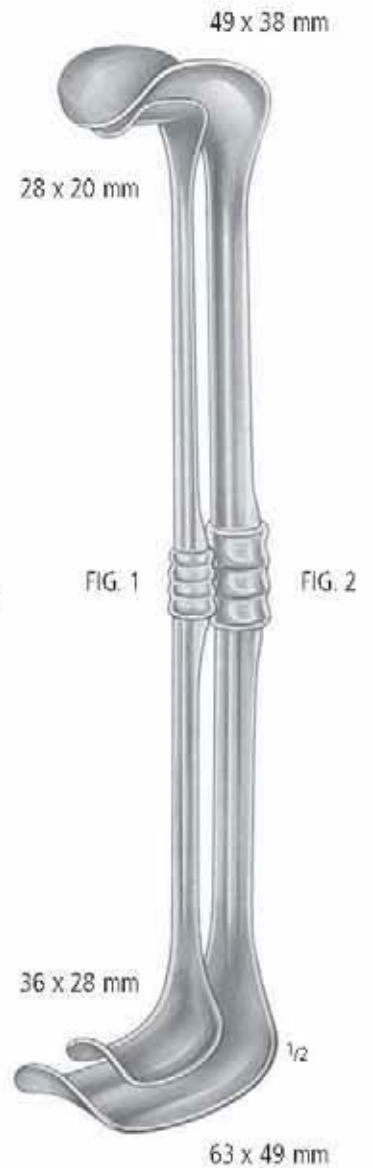

**RICHARDSON-EASTMAN**  
FIG. 1+2 AK 248/00  
FIG. 1 26,0 cm/10½" AK 248/01  
FIG. 2 28,0 cm/11" AK 248/02

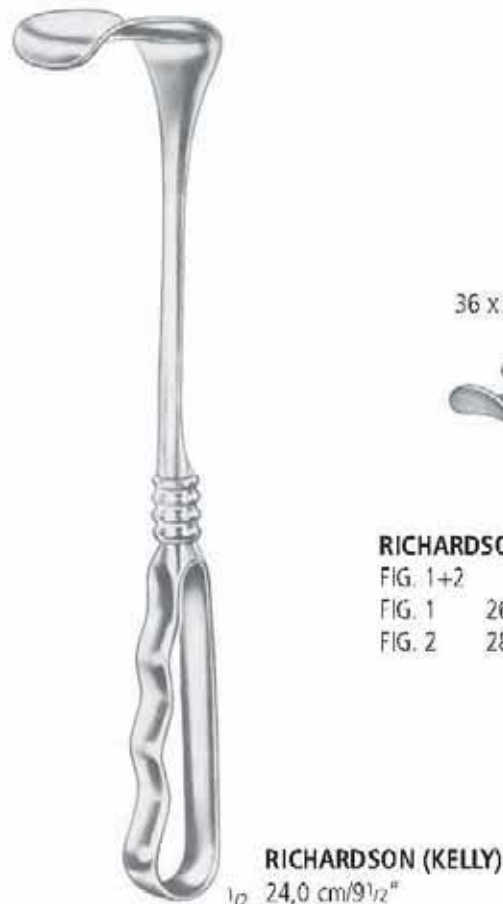





**HOESEL**  
25,0 cm/10"



AK 250/01  
60 x 20 mm



AK 250/02  
80 x 30 mm



AK 250/03  
100 x 30 mm



AK 250/04  
120 x 30 mm



AK 250/05  
140 x 30 mm



AK 250/06  
140 x 40 mm

AA  
AB  
AC  
AD  
AE  
AF  
**AK**  
AL  
AM  
AO  
AP  
AR  
KA  
KD  
KU  
KY

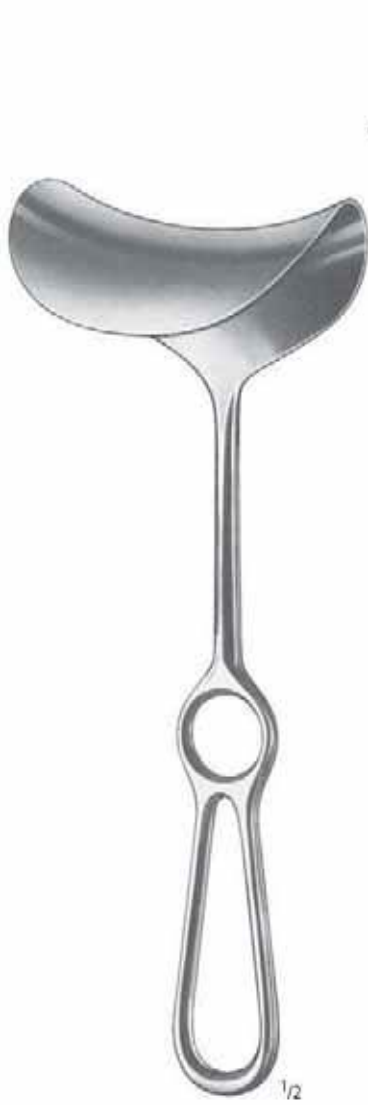

**FRITSCH**  
24,0 cm / 9 1/2"

- |            |           |
|------------|-----------|
| 45 x 40 mm | AK 254/40 |
| 45 x 50 mm | AK 254/50 |
| 45 x 60 mm | AK 254/60 |
| 45 x 75 mm | AK 254/75 |
| 65 x 85 mm | AK 254/85 |



**KOCHER**

- |            |                  |           |
|------------|------------------|-----------|
| 70 x 25 mm | 22,0 cm / 8 3/4" | AK 256/25 |
| 80 x 42 mm | 25,0 cm / 10"    | AK 256/42 |
| 80 x 50 mm | 25,0 cm / 10"    | AK 256/50 |
| 80 x 60 mm | 25,0 cm / 10"    | AK 256/60 |



**DOYEN-STILLE**  
24,0 cm / 9 1/2"

- |             |           |
|-------------|-----------|
| 90 x 15 mm  | AK 258/15 |
| 90 x 20 mm  | AK 258/20 |
| 90 x 30 mm  | AK 258/30 |
| 110 x 35 mm | AK 258/35 |
| 110 x 40 mm | AK 258/40 |
| 120 x 55 mm | AK 258/55 |

AA  
AB  
AC  
AD  
AE  
AF  
AK  
AL  
AM  
AO  
AP  
AR  
KA  
KD  
KU  
KY

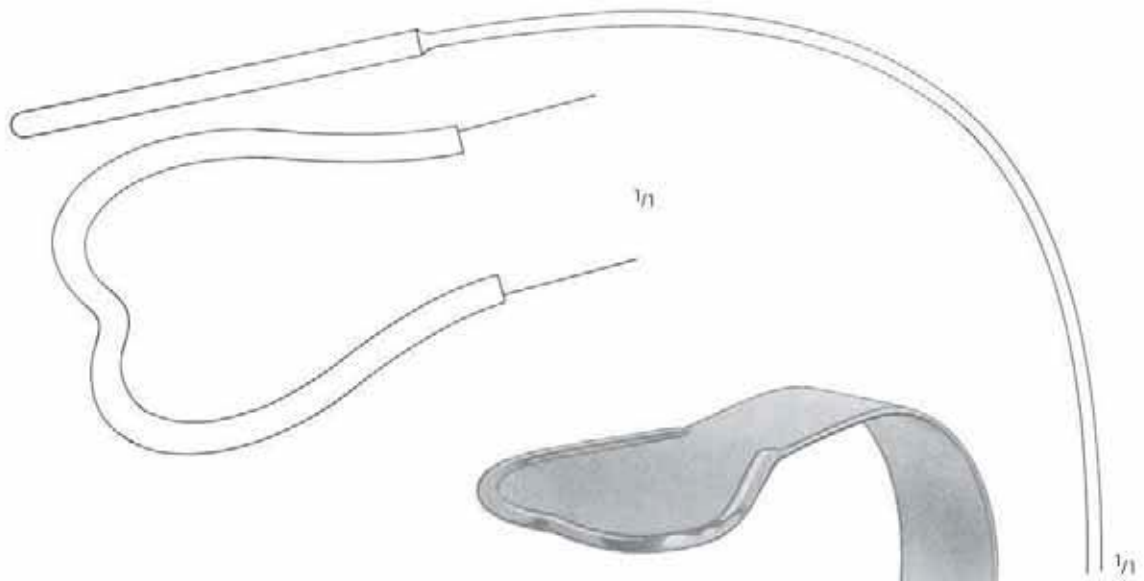

50 x 80 mm

**DOYEN**  
AK 280/25  
25,0 cm/10"



64 x 60 mm

**TUFFIER**  
AK 282/23  
23,0 cm/9"



**HARRINGTON**  
32,0cm/12<sup>3</sup>/<sub>4</sub>"  
127 x 40 mm AK 284/40  
127 x 62 mm AK 284/62  
175 x 64 mm AK 284/64



90 x 50 mm

**MIKULICZ**  
AK 286/26  
26,0 cm/10<sup>1</sup>/<sub>2</sub>"

**MIKULICZ**  
26,0 cm/10<sup>1</sup>/<sub>2</sub>"  
85 x 35 mm AK 290/01  
120 x 50 mm AK 290/02  
155 x 50 mm AK 290/03

**KELLY**  
27,0 cm/10<sup>3</sup>/<sub>4</sub>"  
160 x 38 mm AK 292/01  
160 x 57 mm AK 292/02  
190 x 38 mm AK 292/03  
190 x 57 mm AK 292/04



AA  
AB  
AC  
AD  
AE  
AF  
AK  
AL  
AM  
AO  
AP  
AR  
KA  
KD  
KU  
KY



38 mm

**DEAVER**  
AK 300/07  
30,0 cm/12"



50 mm

**DEAVER**  
AK 300/08  
30,0 cm/12"



75 mm

**DEAVER**  
AK 300/09  
30,0 cm/12"



AA  
AB  
AC  
AD  
AE  
AF  
**AK**  
AL  
AM  
AO  
AP  
AR  
KA  
KD  
KU  
KY



**DEAVER**  
AK 310/01-05

	B	L	
Fig. 1	25 mm	30,5 cm/12"	AK 310/01
Fig. 2	25 mm	33,0 cm/13"	AK 310/02
Fig. 3	38 mm	30,5 cm/12"	AK 310/03
Fig. 4	50 mm	30,5 cm/12"	AK 310/04
Fig. 5	75 mm	30,5 cm/12"	AK 310/05



**KOERTE**  
AK 312/28  
28,0 cm / 11"

fest  
rigid  
rigida  
rigide  
rigide

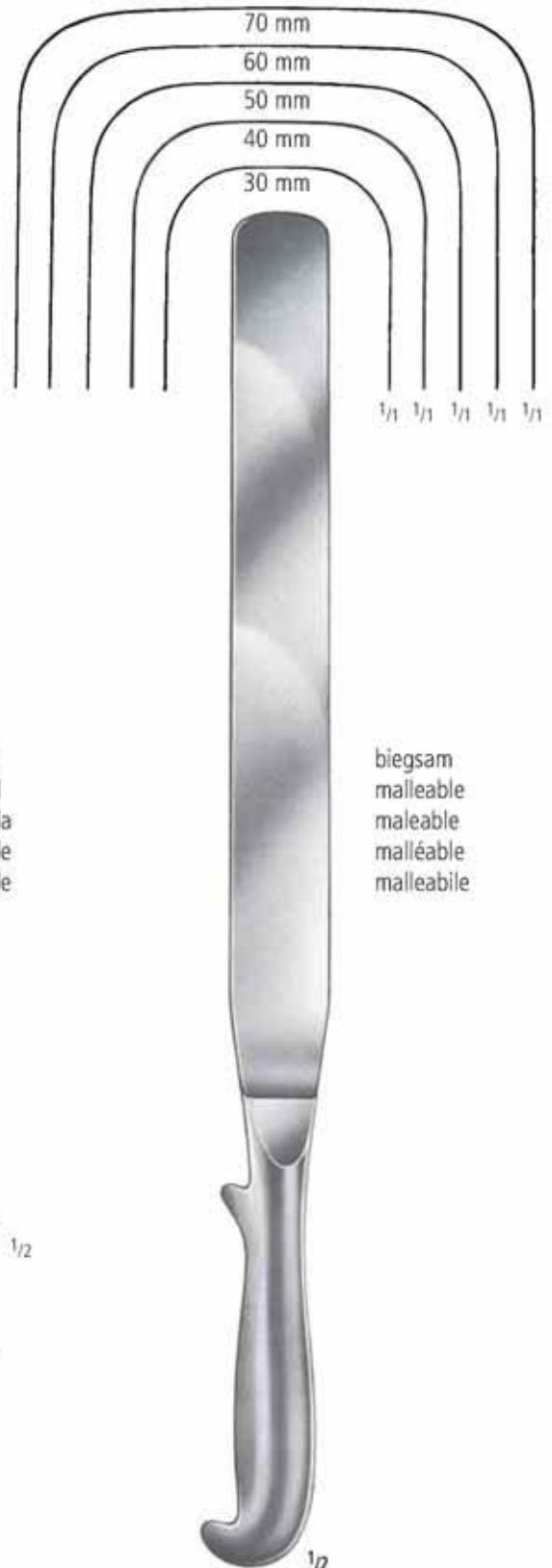

245 x 30 mm	AK 315/30
245 x 40 mm	AK 315/40
245 x 50 mm	AK 315/50
245 x 60 mm	AK 315/60
245 x 70 mm	AK 315/70

biegsam  
malleable  
maleable  
malléable  
malleabile

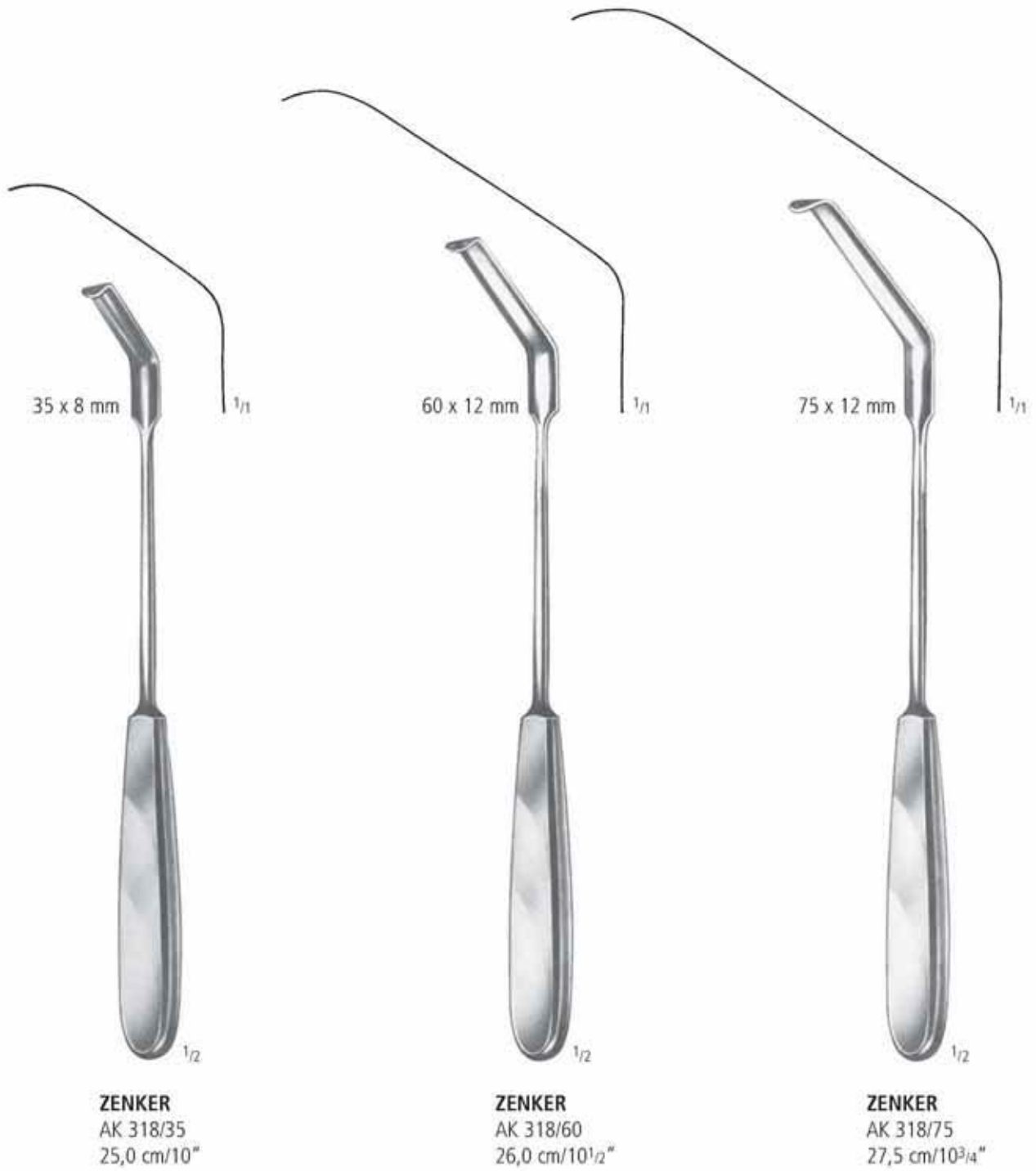

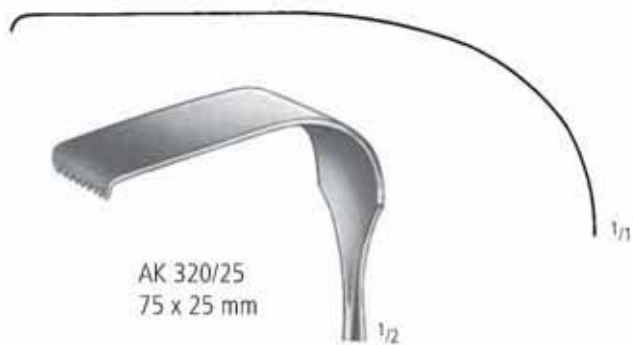

**MEYERDING**  
22,5 cm/9"

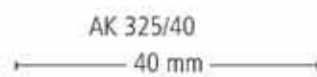
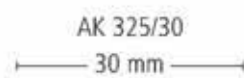
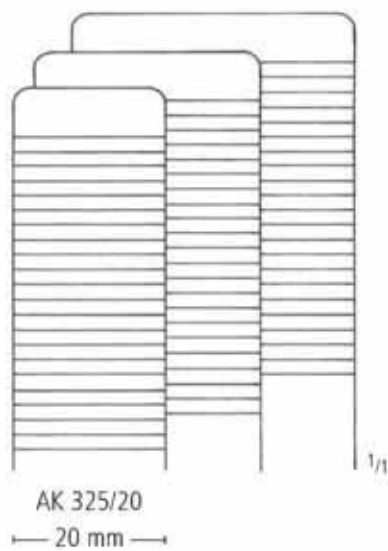

AA  
AB  
AC  
AD  
AE  
AF  
**AK**  
AL  
AM  
AO  
AP  
AR  
KA  
KD  
KU  
KY



**CORYLLOS**  
24,0 cm/9 1/2"



**SAUERBRUCH**  
AK 330/25  
25,0 cm/10"

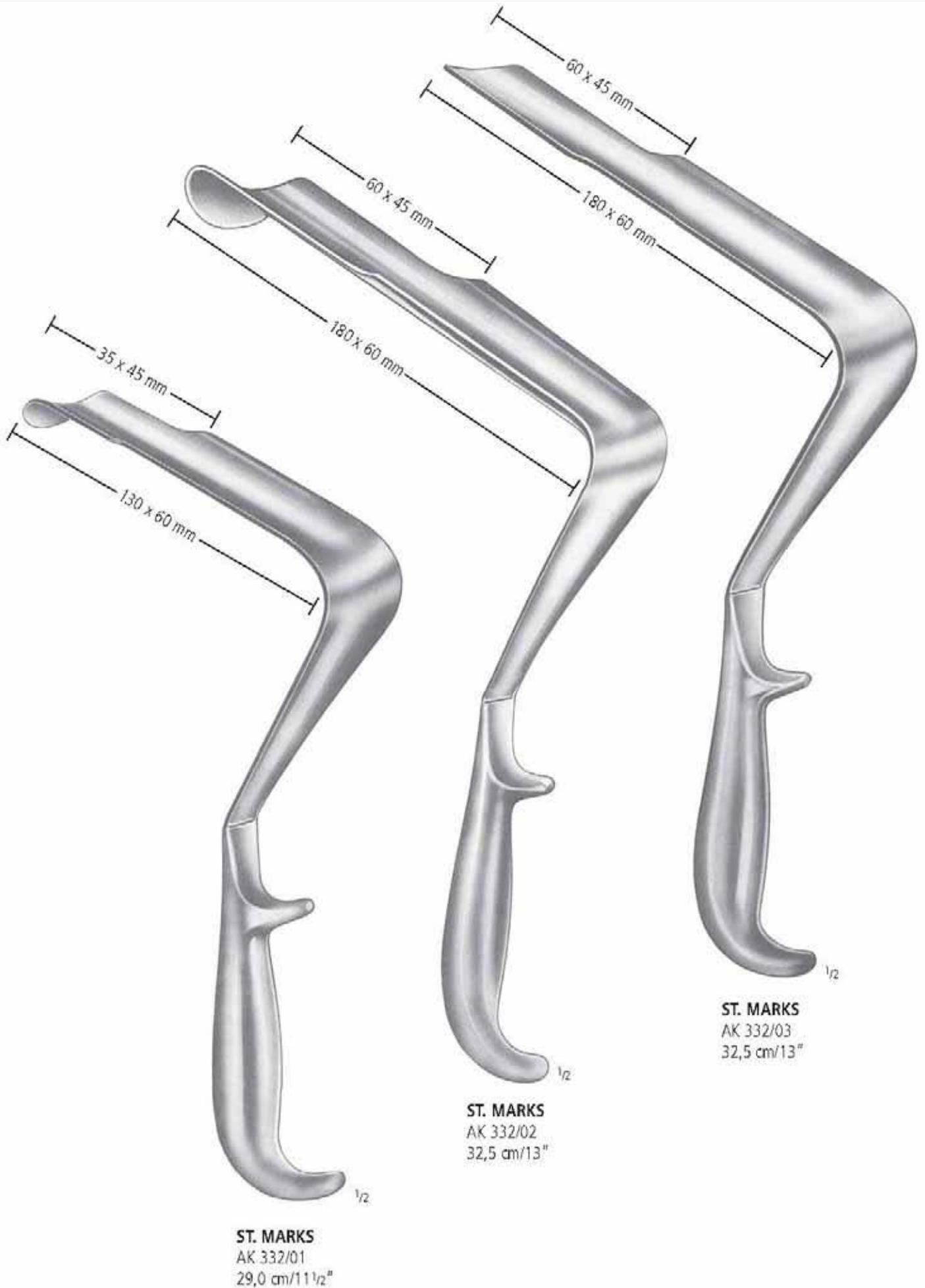

AA  
AB  
AC  
AD  
AE  
AF  
**AK**  
AL  
AM  
AO  
AP  
AR  
KA  
KD  
KU  
KY



75 x 50 mm

**DAVIDSON**  
AK 337/50  
16,0 cm/6 1/4"



75 x 90 mm

**DAVIDSON**  
AK 337/90  
16,0 cm/6 1/4"



AA  
AB  
AC  
AD  
AE  
AF  
AK  
AL  
AM  
AO  
AP  
AR  
KA  
KD  
KU  
KY



**HEANEY**  
27,0 cm/10<sup>3</sup>/<sub>4</sub>"  
45 x 25 mm AK 340/01  
73 x 28 mm AK 340/02  
1/2 82 x 28 mm AK 340/03

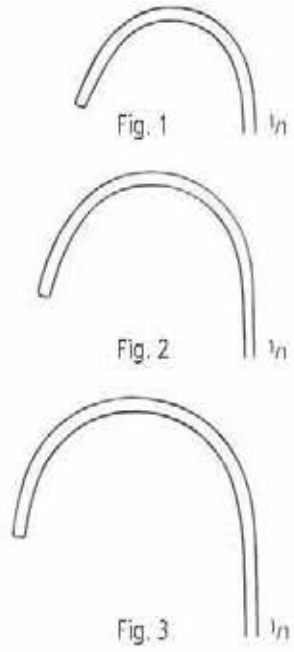

**ROUX**  
16,5 cm/6<sup>1</sup>/<sub>2</sub>"  
Fig. 1+2+3 AK 350/00  
Fig. 1 AK 350/01  
Fig. 2 AK 350/02  
Fig. 3 AK 350/03

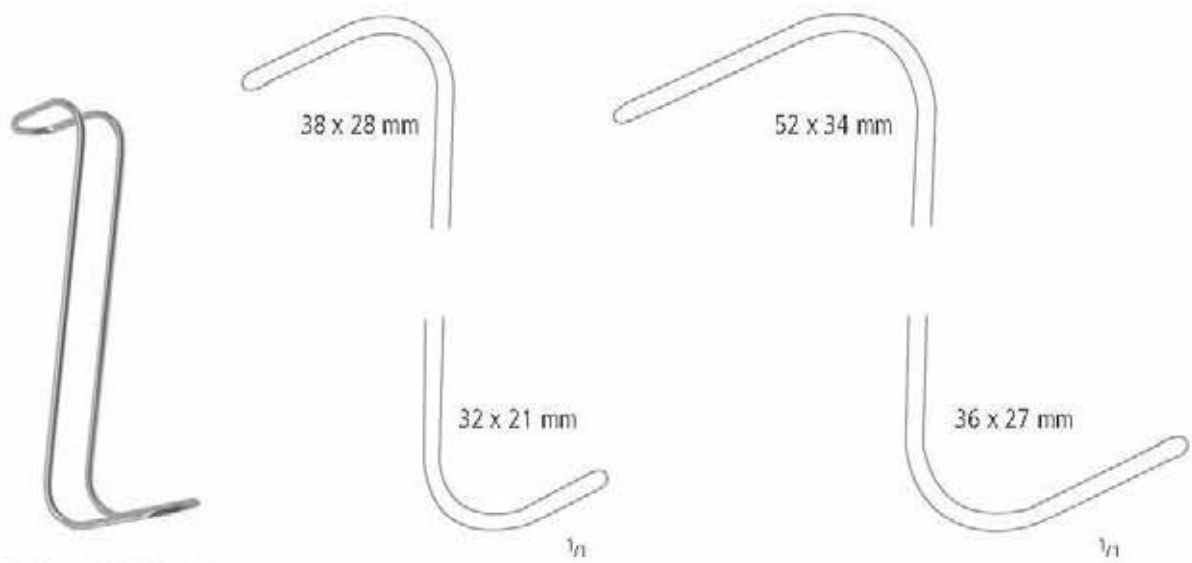

**COLLIN-HARTMANN**  
14,0 cm/5<sup>1</sup>/<sub>2</sub>" AK 351/14  
16,0 cm/6<sup>1</sup>/<sub>4</sub>" AK 351/16



**FARABEUF**  
AK 352/00 Fig. 1+2  
12,0 cm/4<sup>3</sup>/<sub>4</sub>"



**FARABEUF**  
AK 354/00 Fig. 1+2  
15,0 cm/6"



**PARKER**  
AK 373/00 Fig. 1+2  
13,5 cm/5<sup>1</sup>/<sub>4</sub>"



**PARKER**  
AK 374/00 Fig. 1+2  
18,0 cm/7"



**MATHIEU**  
AK 380/00 Fig. 1+2  
20,0 cm/8"

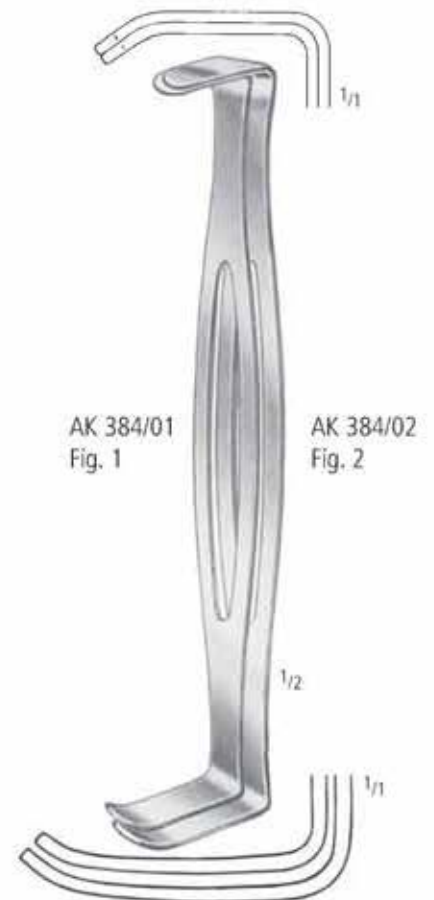

**PARKER-LANGENBECK (U.S. Army)**  
AK 384/00 Fig. 1+2  
21,0 cm/8<sup>1</sup>/<sub>4</sub>"



**CZERNY**  
AK 386/17  
17,5 cm/7"



**GOELET**  
AK 390/19  
19,0 cm/7 1/2"

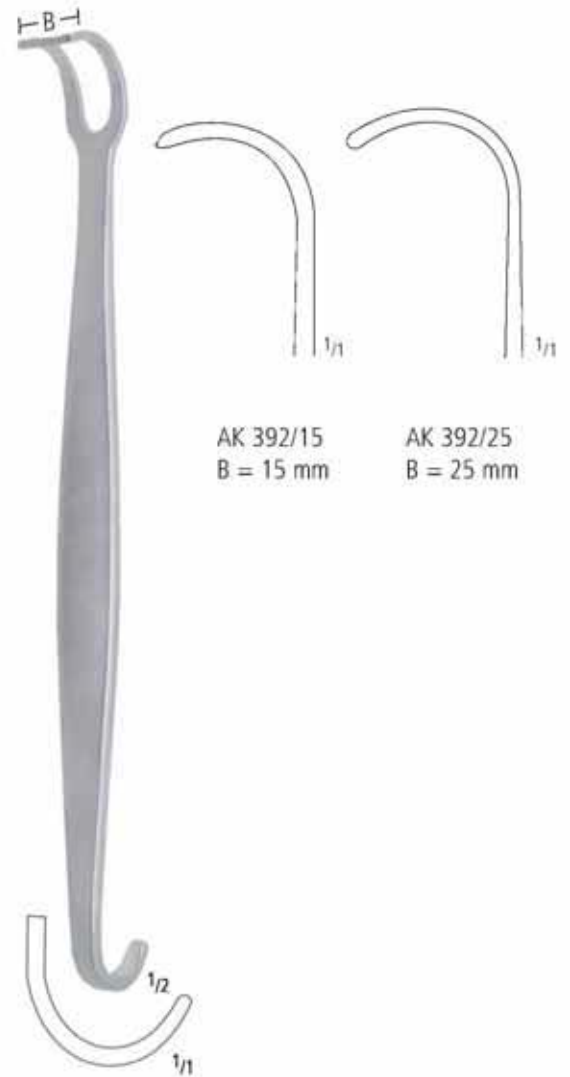

AK 392/15  
B = 15 mm

AK 392/25  
B = 25 mm

**CANNY RYALL**  
21,5 cm/8 1/2"

AA  
AB  
AC  
AD  
AE  
AF  
**AK**  
AL  
AM  
AO  
AP  
AR  
KA  
KD  
KU  
KY

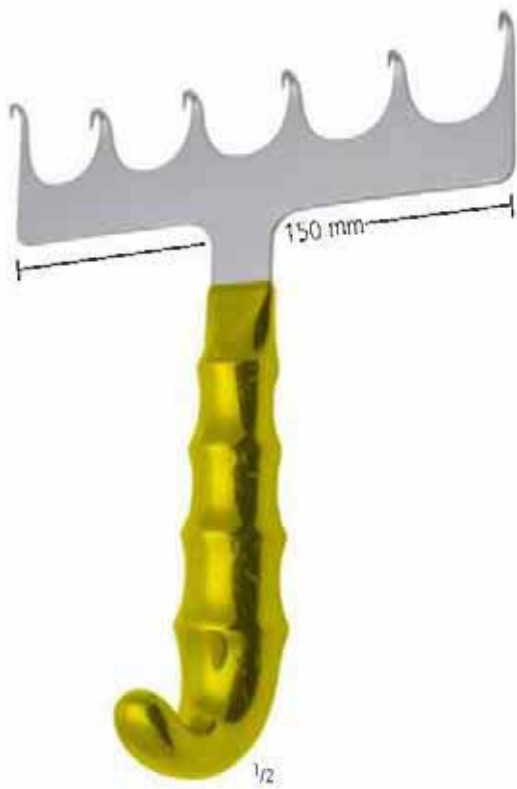

**YANCOSKIE**  
AK 440/15  
18,0 cm/7"



**FERREIRA**  
AK 451/10  
10 cm/4"



Wundhaken mit Kaltlichtbeleuchtung  
Retractor with fibreoptic illumination

AK 452/15



optischer Retraktor  
optical retractor

Zur Verwendung mit Optiken Ø 4 mm, Länge 175 mm  
For use with telescopes Ø 4 mm, 175 mm

AK 453/20

AA  
AB  
AC  
AD  
AE  
AF  
AK  
AL  
AM  
AO  
AP  
AR  
KA  
KD  
KU  
KY

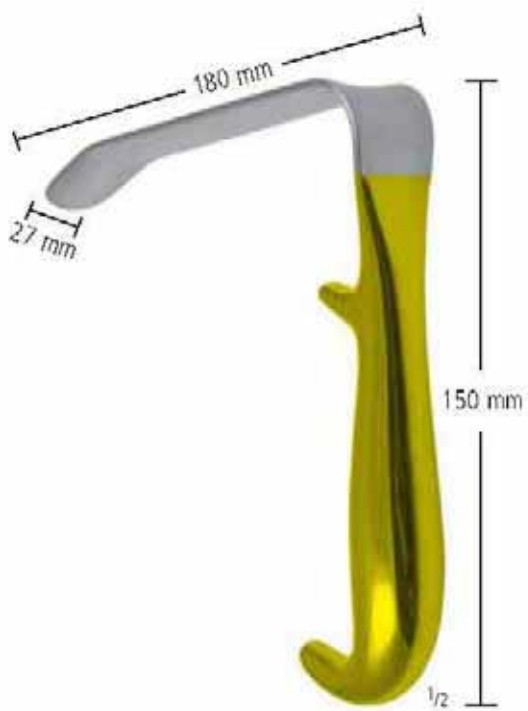

AK 455/01  
18,0 cm/7"



AK 455/16  
16,0 cm/6 1/4"  
für Optik XP 709/30  
for telescope XP 709/30



WUNDHAKEN RETRACTORS SEPARADORES ECARTEURS DIVARICATORI

Selbsthaltende Wundsperrer  
Selfretaining Retractors  
Separadores autoestáticos  
Ecarteurs autostatiques  
Divaricatori autostatici



**FINSEN**

5,0 cm/2"

AK 500/05

AK 501/05

7,0 cm/2<sup>3</sup>/<sub>4</sub>"

AK 500/07

AK 501/07



AK 502/10

AK 503/10

10,0 cm/4"

Fingerwundspreizer  
Finger retractor  
Separador para dedos  
Ecarteur  
Divaricatori



**AUSTRALIA**

AK 505/01

5,0 cm/2"



**ALM**

7,0 cm/2<sup>3</sup>/<sub>4</sub>"

AK 506/07

AK 507/07

10,0 cm/4"

AK 506/10

AK 507/10

AA  
AB  
AC  
AD  
AE  
AF  
AK  
AL  
AM  
AO  
AP  
AR  
KA  
KD  
KU  
KY

Selbsthaltende Wundsperrer  
 Selfretaining Retractors  
 Separadores autoestaticos  
 Ecarteurs autostatiques  
 Divaricatori autostatici



**JANSEN**

AK 510/10      AK 511/10  
 10,0 cm/4"



**SNITMAN**

AK 514/10      AK 515/10  
 10,5 cm/4 1/4"

WUNDHAKEN RETRACTORS SEPARADORES ECARTEURS DIVARICATORI

Wundspreizer für die Handchirurgie  
 Hand surgery retractors  
 Separadores para la cirugía de la mano  
 Ecarteurs de la chirurgie de la main  
 Divaricatori per la chirurgia della mano



**AUSTRALIA** Low profile  
 AK 516/00  
 9,0 cm / 3 1/2"



**AUSTRALIA** Low profile  
 AK 517/00  
 9,0 cm / 3 1/2"



**AUSTRALIA** Low profile  
 AK 518/00  
 9,0 cm / 3 1/2"



6,5 cm / 2 1/2"

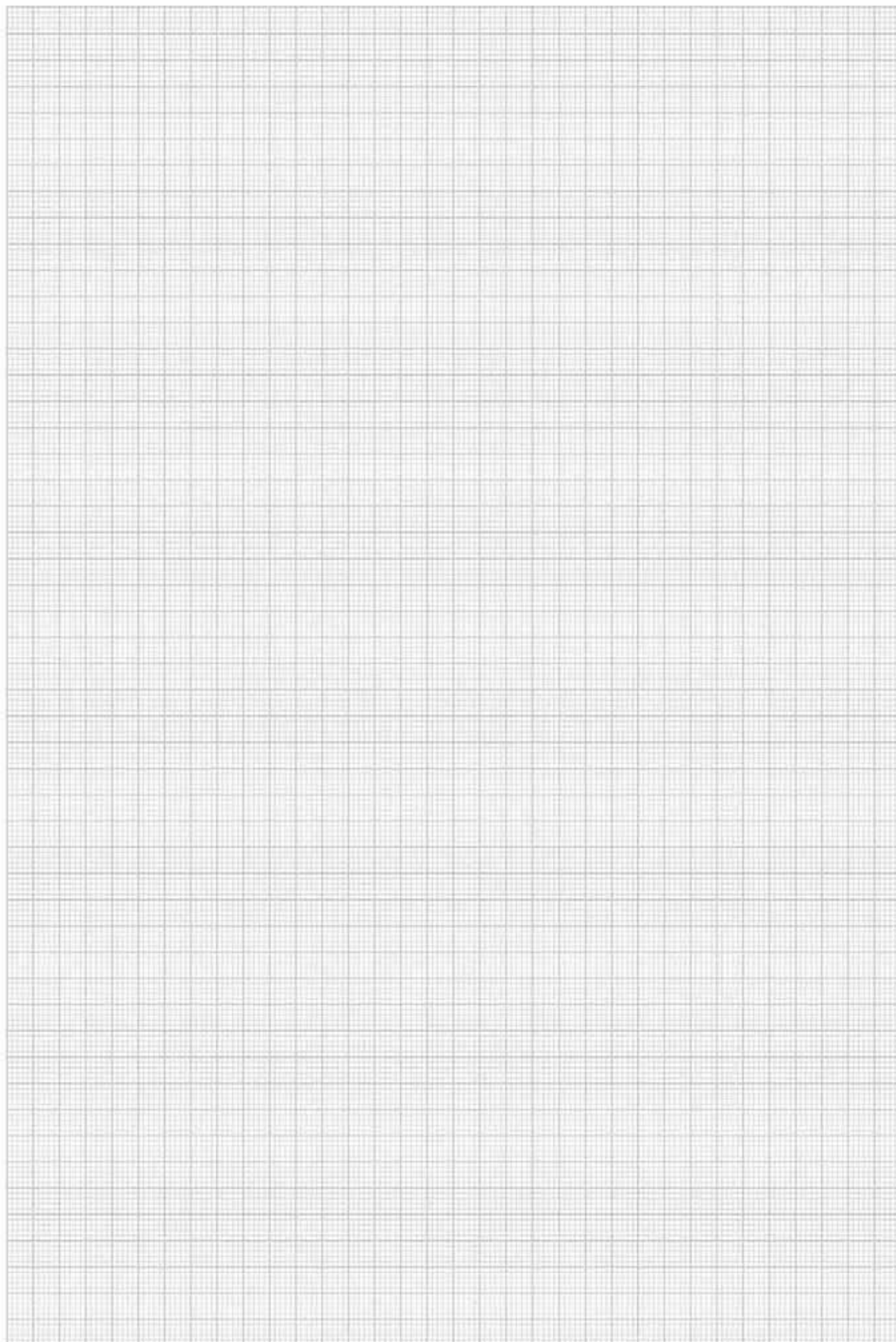

Fig. 1  
 AK 518/12  
 10 x 12 mm



Fig. 2  
 AK 518/18  
 10 x 18 mm

AA  
 AB  
 AC  
 AD  
 AE  
 AF  
**AK**  
 AL  
 AM  
 AO  
 AP  
 AR  
 KA  
 KD  
 KU  
 KY



Selbsthaltende Wundsperrer  
Selfretaining Retractors  
Separadores autoestaticos  
Ecarteurs autostatiques  
Divaricatori autostatici

## WEITLANER



**WEITLANER-BABY**  
AK 519/14  
14,0 cm/5 1/2"



**WEITLANER**  
AK 520/13      AK 521/13  
13,0 cm/5"



**WEITLANER**

10,5 cm/4 1/4"  
13,0 cm/5"  
16,5 cm/6 1/2"  
20,0 cm/8"  
25,0 cm/10"  
26,0 cm/10 1/2"

2 x 3  
3 x 4  
3 x 4  
3 x 4  
3 x 4  
5 x 6

^  
AK 522/10  
AK 524/13  
AK 526/16  
AK 528/20  
AK 530/25  
AK 532/26

∩  
AK 523/10  
AK 525/13  
AK 527/16  
AK 529/20  
AK 531/25  
AK 533/26

AA  
AB  
AC  
AD  
AE  
AF  
**AK**  
AL  
AM  
AO  
AP  
AR  
KA  
KD  
KU  
KY



Selbsthaltende Wundsperrer  
Selfretaining Retractors  
Separadores autoestáticos  
Ecarteurs autostatiques  
Divaricatori autostatici

komplett  
complete  
completo  
complet  
completo

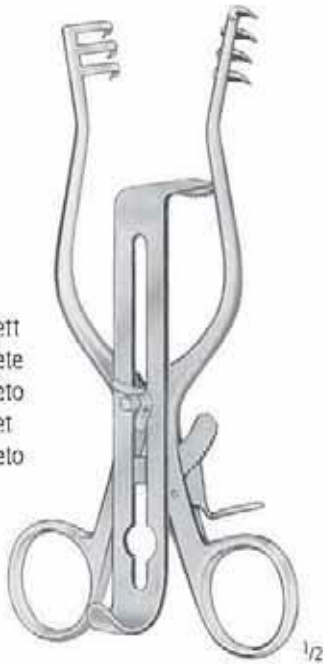

**HENLEY**

AK 536/00      AK 537/00  
16,5 cm/6 1/2"



19 mm x 16 mm  
AK 536/19



25 mm x 16 mm  
AK 536/25



32 mm x 16 mm  
AK 536/32



**MILLIGAN**

AK 538/13      AK 539/13  
13,0 cm/5"



**TRAVERS**

AK 540/21  
21,0 cm/8 1/4"



WUNDHAKEN RETRACTORS SEPARADORES ECARTEURS DIVARICATORI

Selbsthaltende Wundsperrer  
Selfretaining Retractors  
Separadores autoestáticos  
Ecarteurs autostatiques  
Divaricatori autostatici



**SCHUHKNECHT**  
 ^ AK 542/14      ^ AK 543/14  
 14,0 cm/5 1/2"



**WULLSTEIN**  
 ^ AK 544/10      ^ AK 545/10  
 10,5 cm/4 1/4"      AK 544/13      AK 545/13  
 13,0 cm/5"      AK 544/16      AK 545/16  
 16,0 cm/6 1/4"



**MOLLISON**  
 ^ AK 550/15      ^ AK 551/15  
 15,0 cm/6"



**MISKIMON**  
 ^ AK 552/22      ^ AK 553/22  
 22,0 cm/8 3/4"

AA  
AB  
AC  
AD  
AE  
AF  
AK  
AL  
AM  
AO  
AP  
AR  
KA  
KD  
KU  
KY

**AK** WUNDHAKEN RETRACTORS SEPARADORES ECARTEURS DIVARICATORI

Selbsthaltende Wundsperrer  
 Selfretaining Retractors  
 Separadores autoestaticos  
 Ecarteurs autostatiques  
 Divaricatori autostatici



**ADSON**  
 AK 554/20      AK 555/20  
 20,0 cm/8"



**ANDERSON-ADSON**  
 AK 556/20      AK 557/20  
 20,0 cm/8"



**ADSON**  
 AK 558/27      AK 559/27  
 27,0 cm/10<sup>3</sup>/<sub>4</sub>"

WUNDHAKEN RETRACTORS SEPARADORES ECARTEURS DIVARICATORI

Selbsthaltende Wundsperrer  
Selfretaining Retractors  
Separadores autoestáticos  
Ecarteurs autostatiques  
Divaricatori autostatici



**ADSON**  
AK 560/27  
27,0 cm/10<sup>3</sup>/<sub>4</sub>"



**ADSON-R**  
AK 561/01  
27,0 cm/10<sup>3</sup>/<sub>4</sub>"



**ADSON-L**  
AK 561/02  
27,0 cm/10<sup>3</sup>/<sub>4</sub>"

AA  
AB  
AC  
AD  
AE  
AF  
AK  
AL  
AM  
AO  
AP  
AR  
KA  
KD  
KU  
KY

**AK** WUNDHAKEN RETRACTORS SEPARADORES ECARTEURS DIVARICATORI

Selbsthaltende Wundsperrer  
Selfretaining Retractors  
Separadores autoestaticos  
Ecarteurs autostatiques  
Divaricatori autostatici



**ADSON-BABY**  
AK 562/14  
14,0 cm/5 1/2"



**CONE**

13,0 cm/5"  
16,5 cm/6 1/2"  
20,0 cm/8"  
25,0 cm/10"

3 x 4  
3 x 4  
3 x 4  
3 x 4

^  
AK 564/13  
AK 564/16  
AK 564/20  
AK 564/25

∩  
AK 565/13  
AK 565/16  
AK 565/20  
AK 565/25

31,0 cm/12 1/4"  
33,0 cm/13"

4 x 4  
4 x 5

^  
AK 566/31  
AK 568/33

∩  
AK 567/31  
AK 569/33



**BECKMANN**

WUNDHAKEN RETRACTORS SEPARADORES ECARTEURS DIVARICATORI

Selbsthaltende Wundsperrer  
Selfretaining Retractors  
Separadores autoestaticos  
Ecarteurs autostatiques  
Divaricatori autostatici



25 x 25 mm  
25 x 31 mm  
25 x 40 mm  
25 x 45 mm

**BECKMANN-ADSON**  
31,0 cm/12<sup>1</sup>/<sub>4</sub>"

∧  
AK 570/01  
AK 570/02  
AK 570/03  
AK 570/04

∩  
AK 571/01  
AK 571/02  
AK 571/03  
AK 571/04



**BECKMANN-EATON**  
∧ ∩  
AK 572/33 AK 573/33  
33,0 cm/13"

AA  
AB  
AC  
AD  
AE  
AF  
AK  
AL  
AM  
AO  
AP  
AR  
KA  
KD  
KU  
KY



Selbsthaltende Wundsperrer  
Selfretaining Retractors  
Separadores autoestaticos  
Ecarteurs autostatiques  
Divaricatori autostatici



**SCALP-CONTOUR**

AK 574/14      AK 575/14  
14,0 cm/5 1/2"



**GELPI**

9,0 cm/3 1/2"      AK 580/09  
11,0 cm/4 1/3"      AK 580/11  
14,0 cm/5 1/2"      AK 580/14  
19,0 cm/7 1/2"      AK 580/19



**GELPI**

AK 581/19  
19,0 cm/7 1/2"



**MEYERDING**

20,0 cm/8"  
32 x 25 mm      AK 582/01  
54 x 25 mm      AK 582/02  
60 x 19 mm      AK 582/03  
60 x 25 mm      AK 582/04

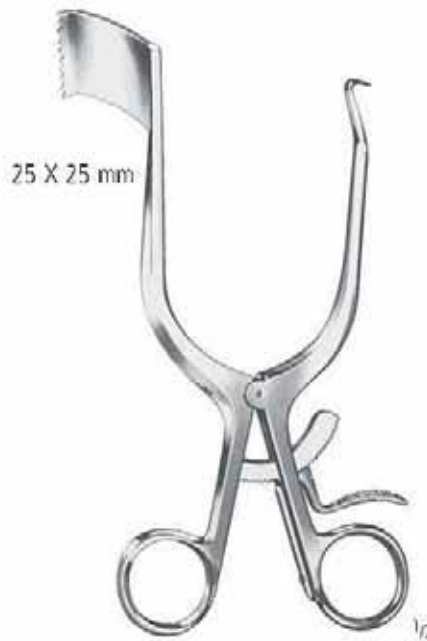

**MARKHAM-MEYERDING**

AK 583/01  
18,0 cm/7"



**MARKHAM-MEYERDING**

AK 583/02  
18,0 cm/7"



WUNDHAKEN RETRACTORS SEPARADORES ECARTEURS DIVARICATORI

Selbsthaltende Wundsperrer  
Selfretaining Retractors  
Separadores autoestaticos  
Ecarteurs autostatiques  
Divaricatori autostatici

AA  
AB  
AC  
AD  
AE  
AF  
AK  
AL  
AM  
AO  
AP  
AR  
KA  
KD  
KU  
KY



**RIGHTBY**  
18,0 cm/7"

35 x 20 mm AK 586/01  
60 x 20 mm AK 586/02  
65 x 15 mm AK 586/03



57 x 25 mm 70 x 38 mm

**DARLING**  
AK 587/01  
18,0 cm/7"



70 x 38 mm 57 x 25 mm

**DARLING**  
AK 587/02  
18,0 cm/7"



**PLESTER**

AK 590/10 AK 590/13  
10,0 cm/4" 13,0 cm/5"



**PLESTER-R**

AK 591/10 AK 591/13  
10,0 cm/4" 13,0 cm/5"



**PLESTER-L**

AK 592/10 AK 592/13  
10,0 cm/4" 13,0 cm/5"

Selbsthaltende Wundsperrer  
 Selfretaining Retractors  
 Separadores autoestáticos  
 Ecarteurs autostatiques  
 Divaricatori autostatici



**TÜBINGER MODELL**

AK 594/16  
 16,5 cm/6<sup>1</sup>/<sub>2</sub>"

AK 594/18  
 18,0 cm/7"



**MAYO-ADAMS**  
 AK 596/17  
 17,0 cm/6<sup>3</sup>/<sub>4</sub>"

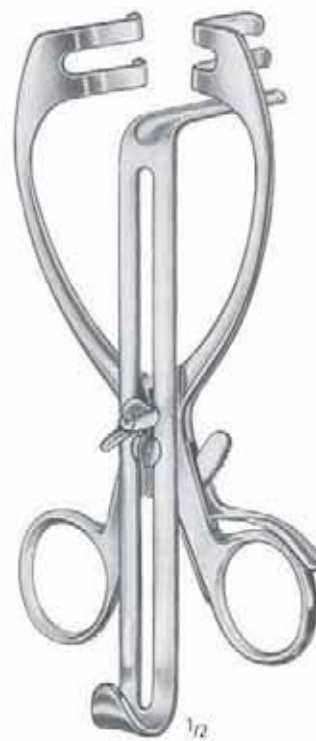

**MAYO-ADAMS**  
 AK 598/17  
 17,0 cm/6<sup>3</sup>/<sub>4</sub>"

WUNDHAKEN RETRACTORS SEPARADORES ECARTEURS DIVARICATORI

Selbsthaltende Wundsperrer  
Selfretaining Retractors  
Separadores autoestáticos  
Ecarteurs autostatiques  
Divaricatori autostatici



**WALTON**  
AK 599/01  
18,0 cm/7"



**WALTON**  
AK 599/02  
18,0 cm/7"



**KNIGHTON**  
AK 600/01  
18,0 cm/7"



**KNIGHTON**  
AK 600/02  
18,0 cm/7"

AA  
AB  
AC  
AD  
AE  
AF  
**AK**  
AL  
AM  
AO  
AP  
AR  
KA  
KD  
KU  
KY

Bauchdeckenhalter  
 Abdominal Retractors  
 Separadores abdominales  
 Ecarteurs abdominaux  
 Divaricatori addominali

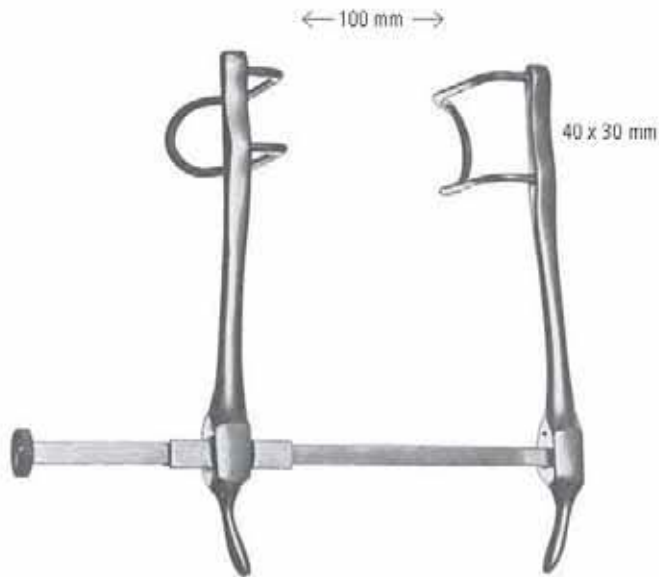

**GOSSET**  
 AK 610/10

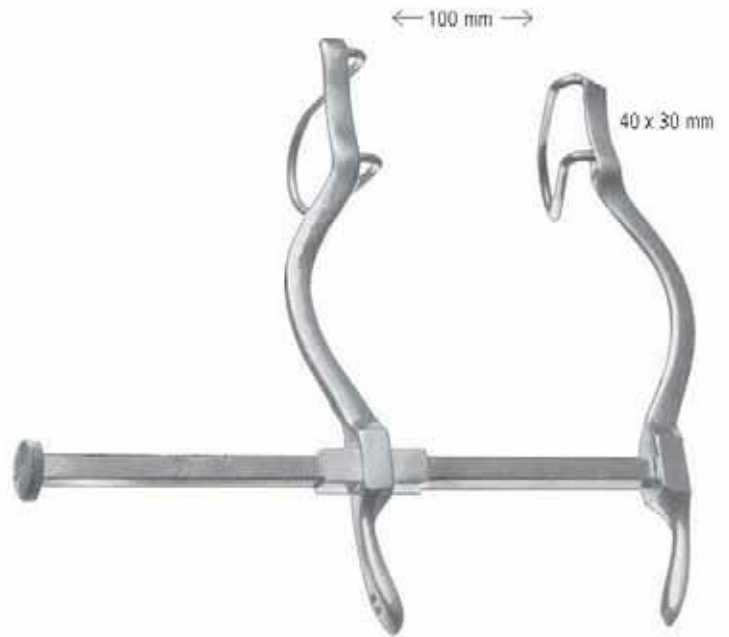

**GOSSET**  
 AK 611/10



**GOSSET**  
 AK 612/14



**GOSSET**  
 AK 613/16

WUNDHAKEN RETRACTORS SEPARADORES ECARTEURS DIVARICATORI

Bauchdeckenhalter  
Abdominal Retractors  
Separadores abdominales  
Ecarteurs abdominaux  
Divaricatori addominali

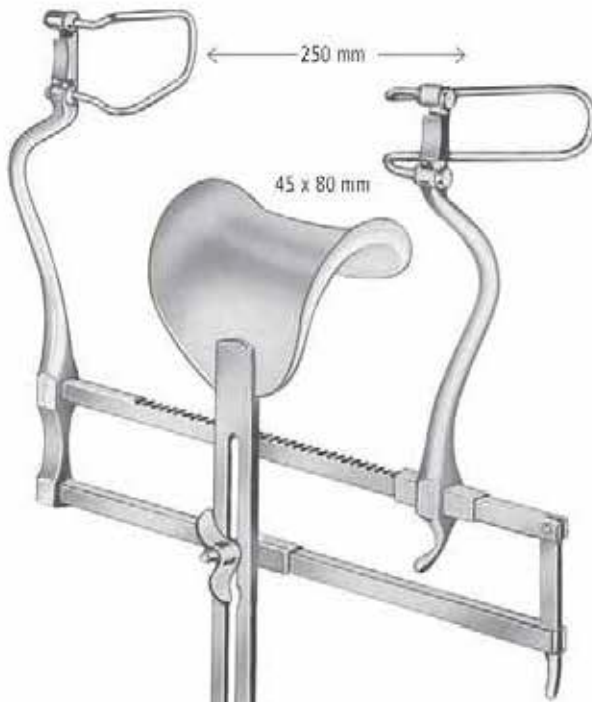

AK 618/01  
70 x 35 mm



AK 618/02  
100 x 35 mm

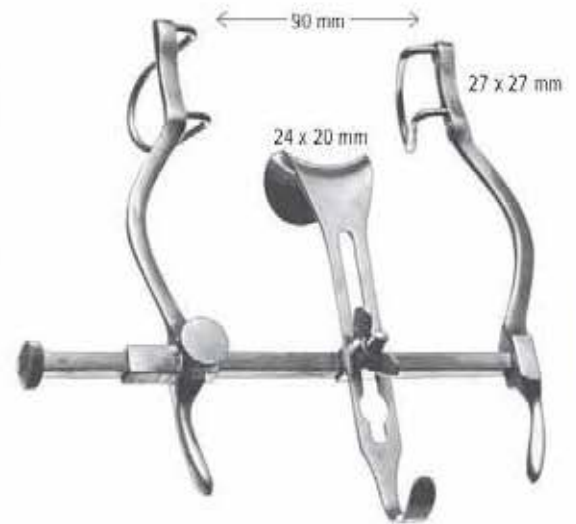

**BALFOUR BABY**  
AK 620/09

**BALFOUR US-TYPE**  
AK 618/00

komplett mit 2 Paar Valven  
complete with 2 pairs of blades  
completo con 2 pares de valvas  
complet avec 2 paires de valves  
completo con 2 pala di valve

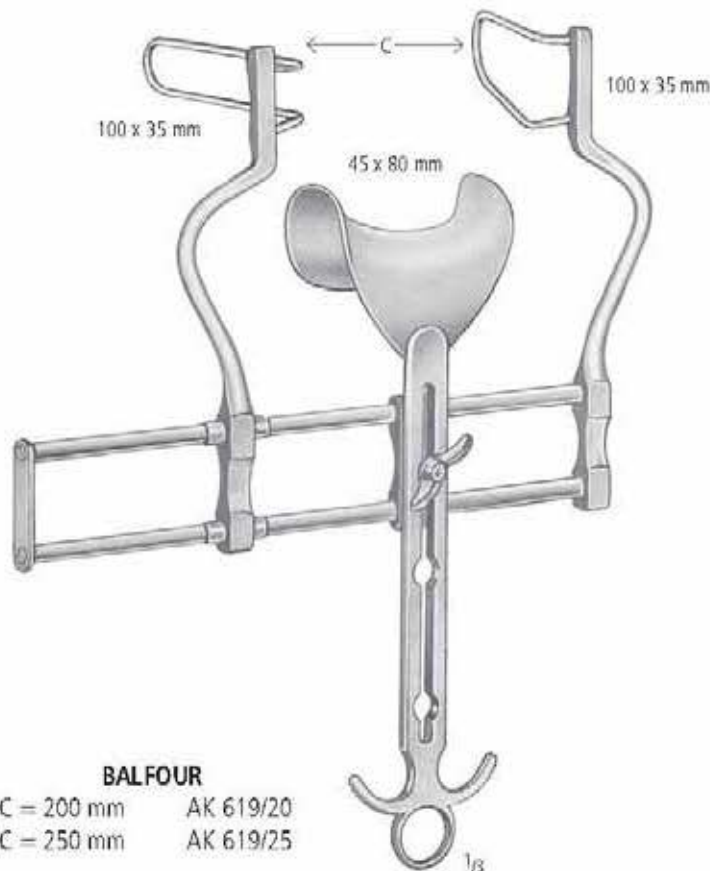

**BALFOUR**  
C = 200 mm AK 619/20  
C = 250 mm AK 619/25

AA  
AB  
AC  
AD  
AE  
AF  
AK  
AL  
AM  
AO  
AP  
AR  
KA  
KD  
KU  
KY



Bauchdeckenhalter  
Abdominal Retractors  
Separadores abdominales  
Ecarteurs abdominaux  
Divaricatori addominali



**BALFOUR**  
AK 620/18

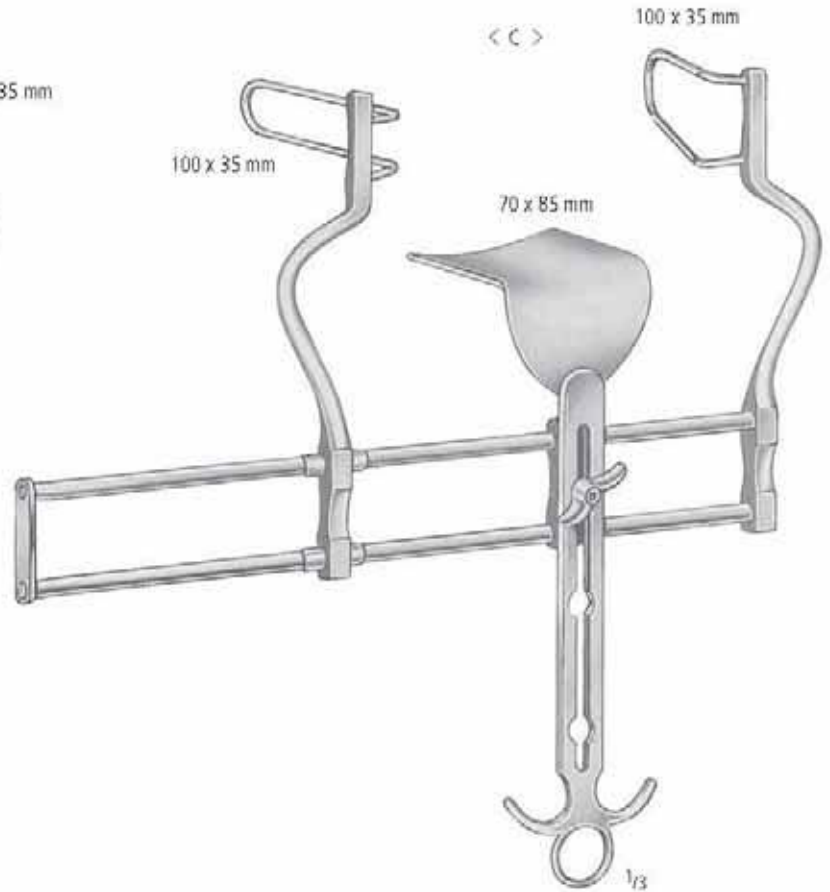

**BALFOUR**  
C = 200 mm AK 620/20  
C = 250 mm AK 620/25



AK 621/70  
100 x 70 mm



**BALFOUR**  
45 x 80 mm AK 622/01  
70 x 85 mm AK 622/02



WUNDHAKEN RETRACTORS SEPARADORES ECARTEURS DIVARICATORI

Bauchdeckenhalter  
Abdominal Retractors  
Separadores abdominales  
Ecarteurs abdominaux  
Divaricatori addominali

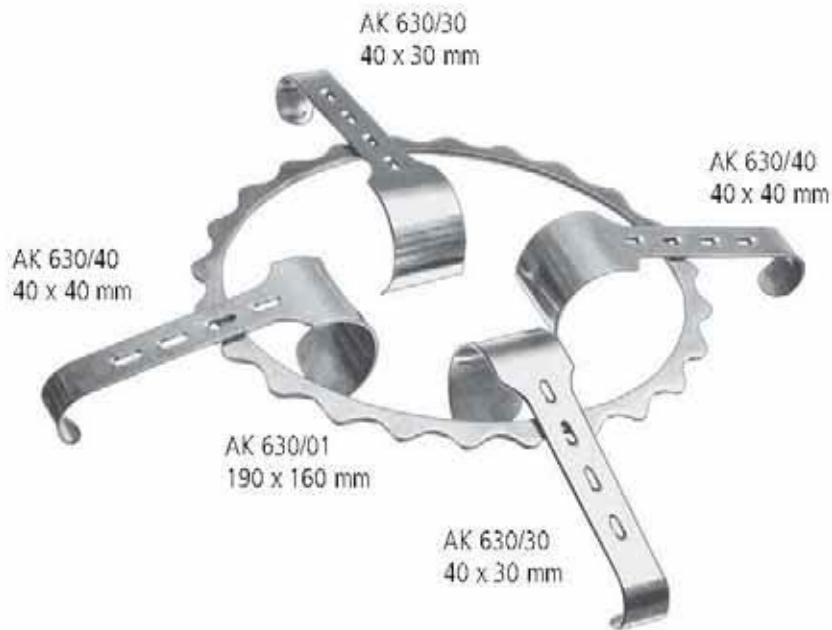

**DENIS BROWNE**

AK 630/00 = 1 x AK 630/01  
2 x AK 630/30  
2 x AK 630/40



AK 632/01



110 x 70 mm  
AK 632/02



80 x 45 mm  
AK 632/03

**O'SULLIVAN-O'CONNOR**

AK 632/00 = 1 x AK 632/01  
1 x AK 632/02  
2 x AK 632/03

**AK** WUNDHAKEN RETRACTORS SEPARADORES ECARTEURS DIVARICATORI

Bauchdeckenhalter  
Abdominal Retractors  
Separadores abdominales  
Ecarteurs abdominaux  
Divaricatori addominali



**DOYEN**

28,0 cm/11"

- 55 x 95 mm AK 645/01
- 55 x 105 mm AK 645/02
- 55 x 115 mm AK 645/03
- 55 x 125 mm AK 645/04

AK 650/01  
300 x 300 mm



AK 650/38  
38 x 60 mm



AK 650/50  
50 x 65 mm

AK 650/50  
50 x 65 mm

AK 650/38  
38 x 60 mm

**FRANZ**

- AK 650/00 = 1 x AK 650/01
- + 2 x AK 650/38
- + 2 x AK 650/50

AK 655/45  
45 x 80 mm



AK 655/60  
60 x 85 mm



AK 655/60  
60 x 85 mm



**FRANZ**

- AK 655/00 = 1 x AK 650/01
- + 2 x AK 650/38
- + 2 x AK 650/50
- + 2 x AK 655/45
- + 2 x AK 655/60

AK 655/45  
45 x 80 mm



AK 656/35  
105 x 35 mm



AK 656/50  
98 x 50 mm

WUNDHAKEN RETRACTORS SEPARADORES ECARTEURS DIVARICATORI

Bauchdeckenhalter  
Abdominal Retractors  
Separadores abdominales  
Ecarteurs abdominaux  
Divaricatori addominali



**KIRSCHNER**

AK 660/00 = 1 x AK 660/01  
2 x AK 660/40  
2 x AK 660/50

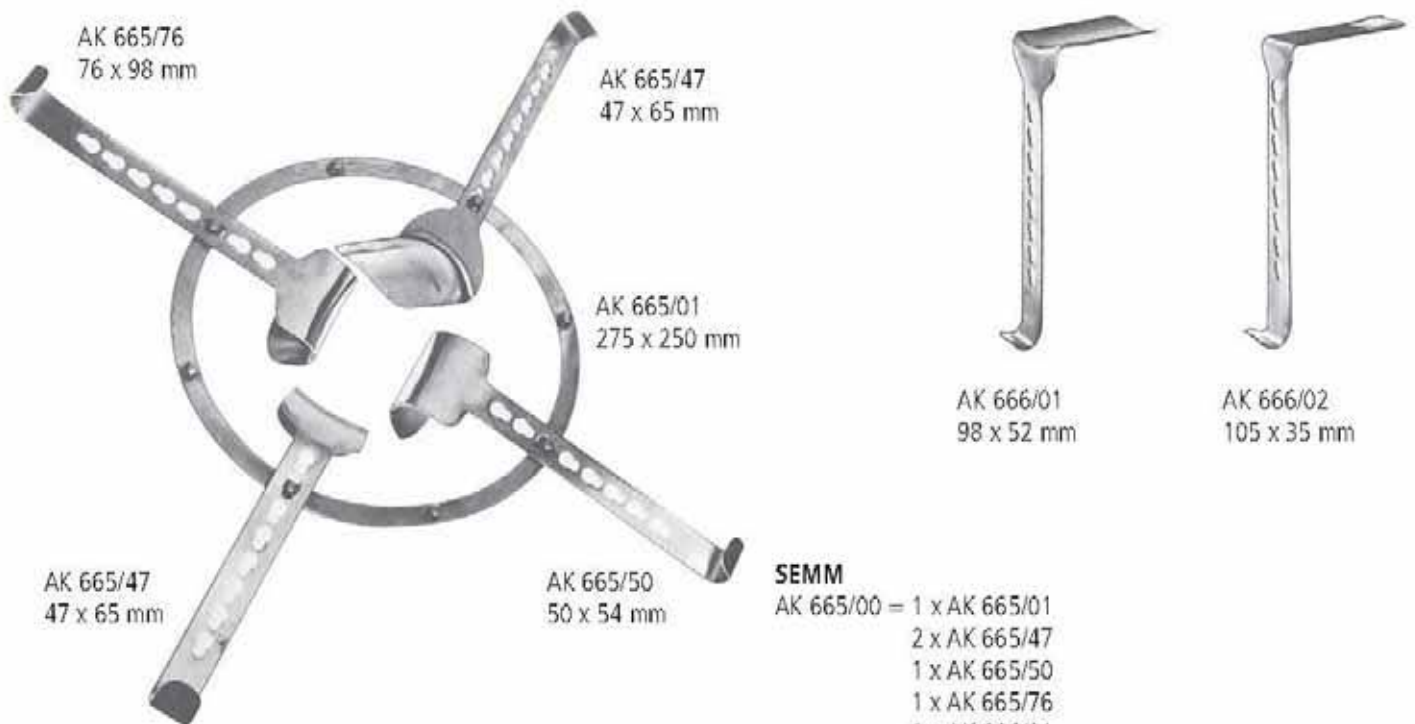

**SEMM**

AK 665/00 = 1 x AK 665/01  
2 x AK 665/47  
1 x AK 665/50  
1 x AK 665/76  
1 x AK 666/01  
1 x AK 666/02

AA  
AB  
AC  
AD  
AE  
AF  
AK  
AL  
AM  
AO  
AP  
AR  
KA  
KD  
KU  
KY

Bauchdeckenhalter  
 Abdominal Retractors  
 Separadores abdominales  
 Ecarteurs abdominaux  
 Divaricatori addominali

AK 700/23  
 23 x 44 mm



AK 700/30  
 30 x 44 mm



komplett  
 complete  
 completo  
 complet  
 completo

**COLLIN-BABY**  
 AK 700/00  
 18,0 cm/7"

← 165 mm →



AK 702/16  
 AK 704/16

**COLLIN**

S  
 50 x 58 mm  
 62 x 80 mm

M  
 62 x 67 mm  
 62 x 67 mm

WUNDHAKEN RETRACTORS SEPARADORES ECARTEURS DIVARICATORI

Bauchdeckenhalter  
Abdominal Retractors  
Separadores abdominales  
Ecarteurs abdominaux  
Divaricatori addominali



**COLLIN**  
AK 706/10  
22,0 cm/8<sup>3</sup>/<sub>4</sub>"

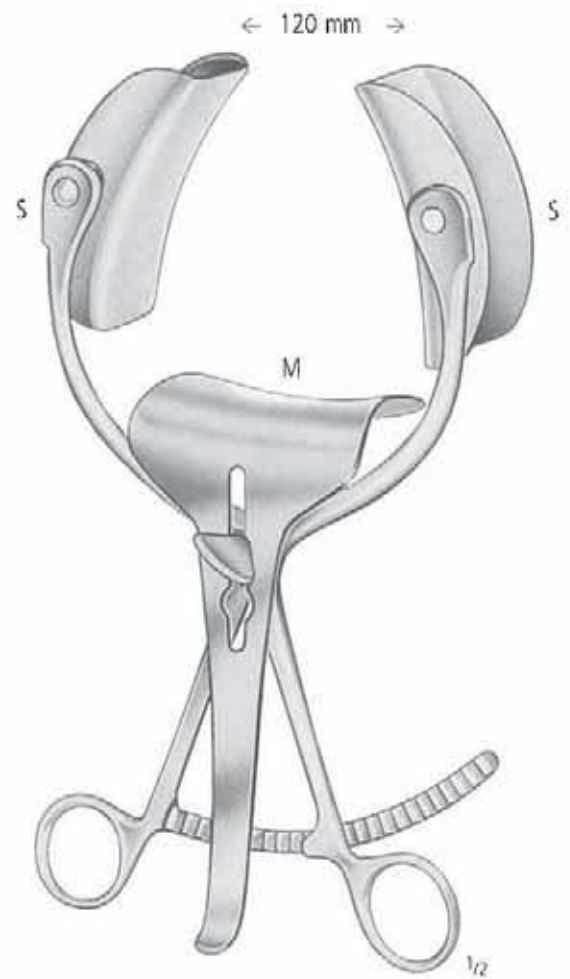

	<b>COLLIN</b>	
	S	M
AK 708/12	38 x 62 mm	55 x 55 mm
AK 709/12	38 x 80 mm	55 x 65 mm
AK 710/12	38 x 100 mm	55 x 75 mm

AA  
AB  
AC  
AD  
AE  
AF  
AK  
AL  
AM  
AO  
AP  
AR  
KA  
KD  
KU  
KY



Bauchdeckenhalter  
 Abdominal Retractors  
 Separadores abdominales  
 Ecarteurs abdominaux  
 Divaricatori addominali

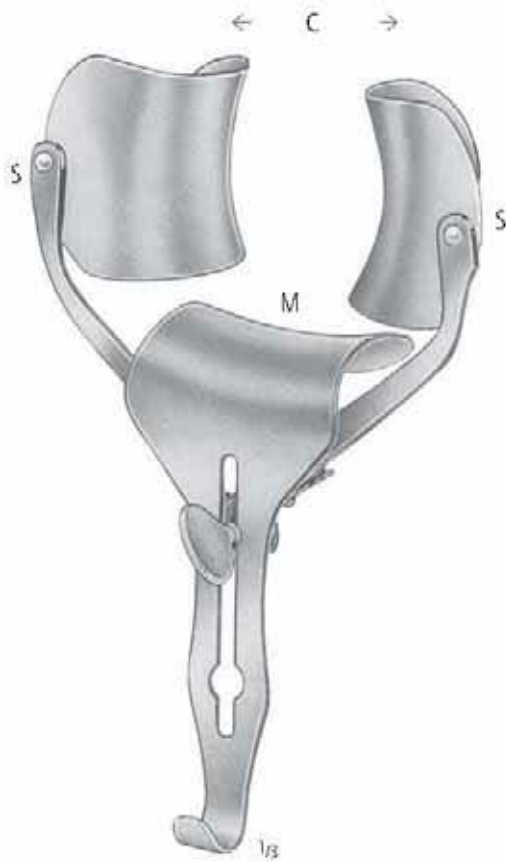

**RICARD**

	S	M	C
AK 712/28	72 x 85 mm	80 x 90 mm	280 mm
AK 712/30	60 x 80 mm	55 x 70 mm	300 mm



**ROBIN-MASSE**

AK 715/00



WUNDHAKEN RETRACTORS SEPARADORES ECARTEURS DIVARICATORI

Bauchdeckenhalter  
 Abdominal Retractors  
 Separadores abdominales  
 Ecarteurs abdominaux  
 Divaricatori addominali



38 x 62 mm     AK 725/06  
 38 x 80 mm     AK 725/08  
 38 x 100 mm    AK 725/10

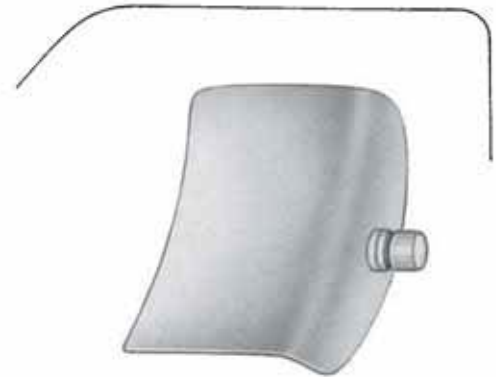

AK 726/80  
 62 x 80 mm

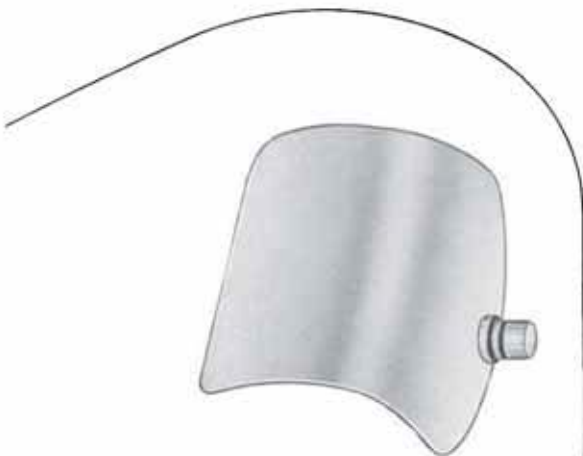

50 x 58 mm     AK 727/58  
 60 x 80 mm     AK 727/80  
 72 x 85 mm     AK 727/85



AK 728/80  
 62 x 80 mm

AA  
 AB  
 AC  
 AD  
 AE  
 AF  
**AK**  
 AL  
 AM  
 AN  
 AO  
 AP  
 AR  
 AS  
 AT  
 AU  
 AV  
 AW  
 AX  
 AY  
 AZ

Bauchspatel  
Abdominal Spatulas  
Espátulas abdominales  
Spatules abdominales  
Spatole addominali

biegsam  
malleable  
maleables  
malleables  
malleabili



200 x 12 mm	AK 800/12
200 x 17 mm	AK 800/17
200 x 25 mm	AK 800/25
250 x 25 mm	AK 802/25

biegsam  
malleable  
maleables  
malleables  
malleabili



33,0 cm/13"

30 mm	AK 804/30
40 mm	AK 804/40
50 mm	AK 804/50

biegsam  
malleable  
maleables  
malleables  
malleabili



25 mm

20,0 cm/8"

17 mm

**TUFFIER**  
AK 805/20

biegsam  
malleable  
maleables  
malleables  
malleabili



25/30 mm
37/45 mm
40/50 mm

**HABERER**

28,0 cm/11"	AK 807/30
30,0 cm/12"	AK 807/45
30,0 cm/12"	AK 807/50



45 mm

**REVERDIN**

AK 809/29  
29,0 cm/11½"

60 mm

---

SONDEN  
PROBES  
SONDAS  
SONDES  
SONDE

AL

nopa<sup>®</sup> instruments



Sonden  
Probes  
Sondas  
Sondes  
Sonde



Silber  
silver  
de plata  
en argent  
d'argento



	1,0 mm	2,0 mm
11,5 cm/4 <sup>1</sup> / <sub>2</sub> "	AL 001/11	AL 002/11
13,0 cm/5"	AL 001/13	AL 002/13
14,5 cm/5 <sup>3</sup> / <sub>4</sub> "	AL 001/14	AL 002/14
16,0 cm/6 <sup>1</sup> / <sub>4</sub> "	AL 001/16	AL 002/16
18,0 cm/7"	AL 001/18	AL 002/18
20,0 cm/8"	AL 001/20	AL 002/20
25,0 cm/10"	AL 001/25	AL 002/25

AL 003/11  
AL 003/13  
AL 003/14  
AL 003/16  
AL 003/18  
AL 003/20  
AL 003/25

**MYRTLE LEAF**

AL 007/14  
AL 007/16  
AL 007/18  
AL 007/20

**STACKE**  
AL 013/10  
10,5 cm/4<sup>1</sup>/<sub>4</sub>"  
Ø 1,0 mm



11,5 cm/4 <sup>1</sup> / <sub>2</sub> "	AL 015/11
13,0 cm/5"	AL 015/13
14,5 cm/5 <sup>3</sup> / <sub>4</sub> "	AL 015/14
16,0 cm/6 <sup>1</sup> / <sub>4</sub> "	AL 015/16
18,0 cm/7"	AL 015/18
20,0 cm/8"	AL 015/20

**DOYEN**  
  
AL 017/14

AL 020/11  
AL 020/13  
AL 020/14  
AL 020/16  
AL 020/18

**NELATON**  
  
AL 022/16

SONDEN PROBES SONDAS SONDES SONDE

Sonden und Watteträger  
 Probes and Cotton Applicators  
 Sondas y Porta-algodones  
 Sondes et Porte-coton  
 Sonde e Portacotone

AA

AB

AC

AD

AE

AF

AK

AL

AM

AO

AP

AR

KA

KD

KU

KY



**BRODIE**  
 AL 026/20  
 20,0 cm/8"



**LOCKHART-MUMMERY**  
 Fig. 1  
 AL 030/01



**LOCKHART-MUMMERY**  
 Fig. 2  
 AL 030/02



**LOCKHART-MUMMERY**  
 Fig. 3  
 AL 030/03

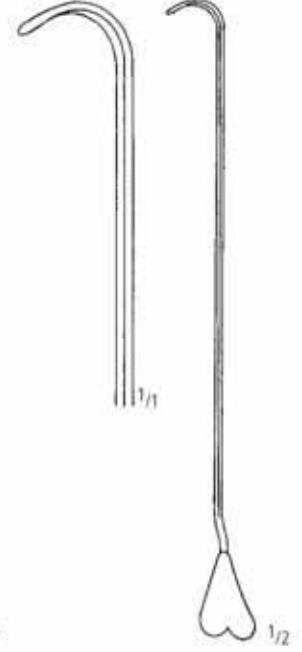

**LOCKHART-MUMMERY**  
 Fig. 4  
 AL 030/04



**PRATT**  
 21,0 cm/8<sup>1</sup>/<sub>4</sub>"



AL 035/01



AL 035/02



AL 035/03



**FARRELL**  
 0,9 mm AL 100/12  
 1,1 mm AL 100/14  
 1,2 mm AL 100/16  
 AL 100/18



**FARRELL**  
 0,9 mm AL 120/12  
 1,1 mm AL 120/14  
 1,2 mm AL 120/16  
 AL 120/18

**AL** SONDEN PROBES SONDAS SONDES SONDE

Watteträger und Krampfader-Besteck  
 Cotton Applicators and Varicose Vein Probe Set  
 Porta- algodones y sonda para várices  
 Porte-coton et trousse à varices  
 Portacotone e astuccio per varici

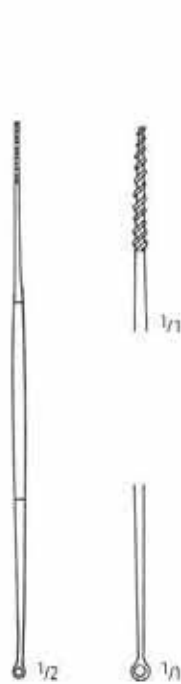

**UCKERMANN**  
 AL 160/16  
 16,0 cm/6 1/4"

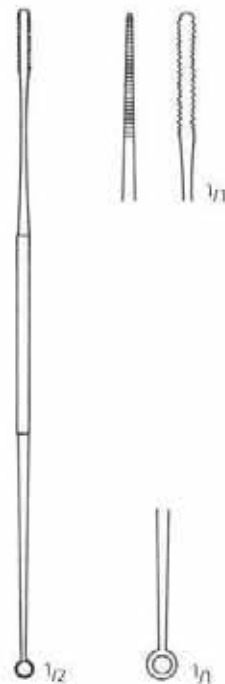

**JOBSON-HORNE**  
 AL 162/18  
 18,0 cm/7"

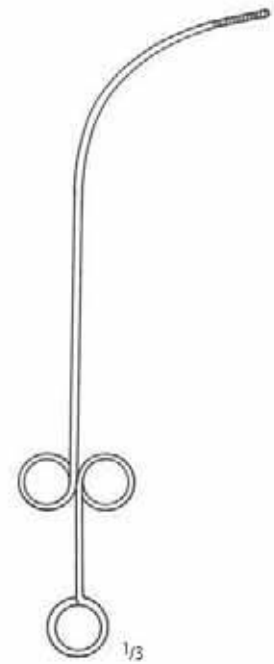

**FEIN**  
 AL 170/28  
 28,0 cm/11"



3,0 mm  
 AL 182/03



6,0 mm  
 AL 182/06



9,0 mm  
 AL 182/09



12,0 mm  
 AL 182/12

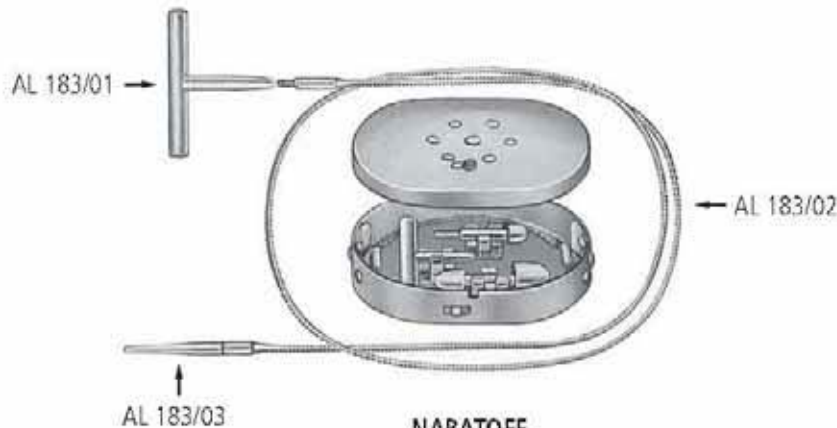

**NABATOFF**  
 AL 180/00

komplett-complete-completo-complet-completo



SONDEN PROBES SONDAS SONDES SONDE

Gefäß-Dilatatoren  
 Vascular Dilators  
 Dilatadores vasculares  
 Dilatateurs vasculaires  
 Dilatatori per vasi

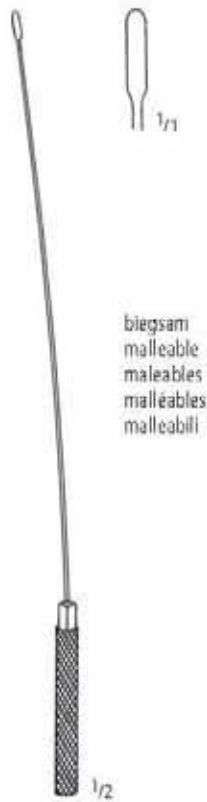

biegsam  
 malleable  
 malleables  
 malleables  
 malleabili

	14,0 cm/5 1/2"	21,0 cm/8 1/4"
1,0 mm	AL 190/10	AL 192/10
1,5 mm	AL 190/15	AL 192/15
2,0 mm	AL 190/20	AL 192/20
2,5 mm	AL 190/25	AL 192/25
3,0 mm	AL 190/30	AL 192/30
3,5 mm	AL 190/35	AL 192/35
4,0 mm	AL 190/40	AL 192/40
4,5 mm	AL 190/45	AL 192/45
5,0 mm	AL 190/50	AL 192/50

**GARRETT**

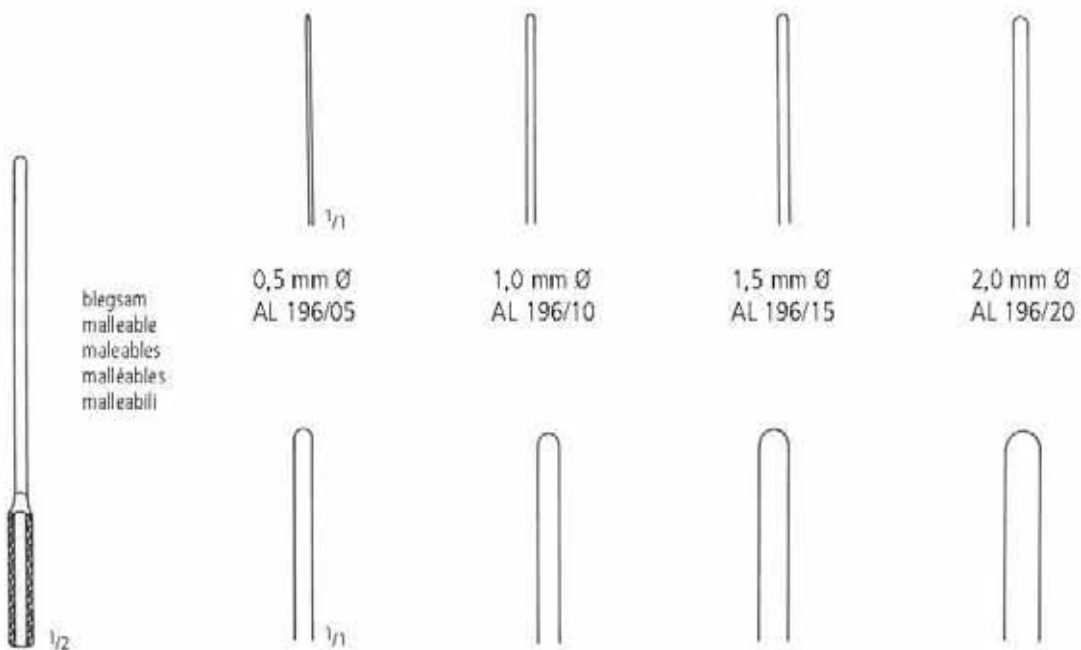

biegsam  
 malleable  
 malleables  
 malleables  
 malleabili

0,5 mm Ø  
 AL 196/05

1,0 mm Ø  
 AL 196/10

1,5 mm Ø  
 AL 196/15

2,0 mm Ø  
 AL 196/20

2,5 mm Ø  
 AL 196/25

3,0 mm Ø  
 AL 196/30

4,0 mm Ø  
 AL 196/40

5,0 mm Ø  
 AL 196/50

**COOLEY**  
 13,0 cm/5"

AA  
 AB  
 AC  
 AD  
 AE  
 AF  
 AK  
**AL**  
 AM  
 AO  
 AP  
 AR  
 KA  
 KD  
 KU  
 KY

**AL** SONDEN PROBES SONDAS SONDES SONDE

Gefäss-Dilatatoren  
 Vascular Dilators  
 Dilatadores vasculares  
 Dilatateurs vasculaires  
 Dilatatori per vasi

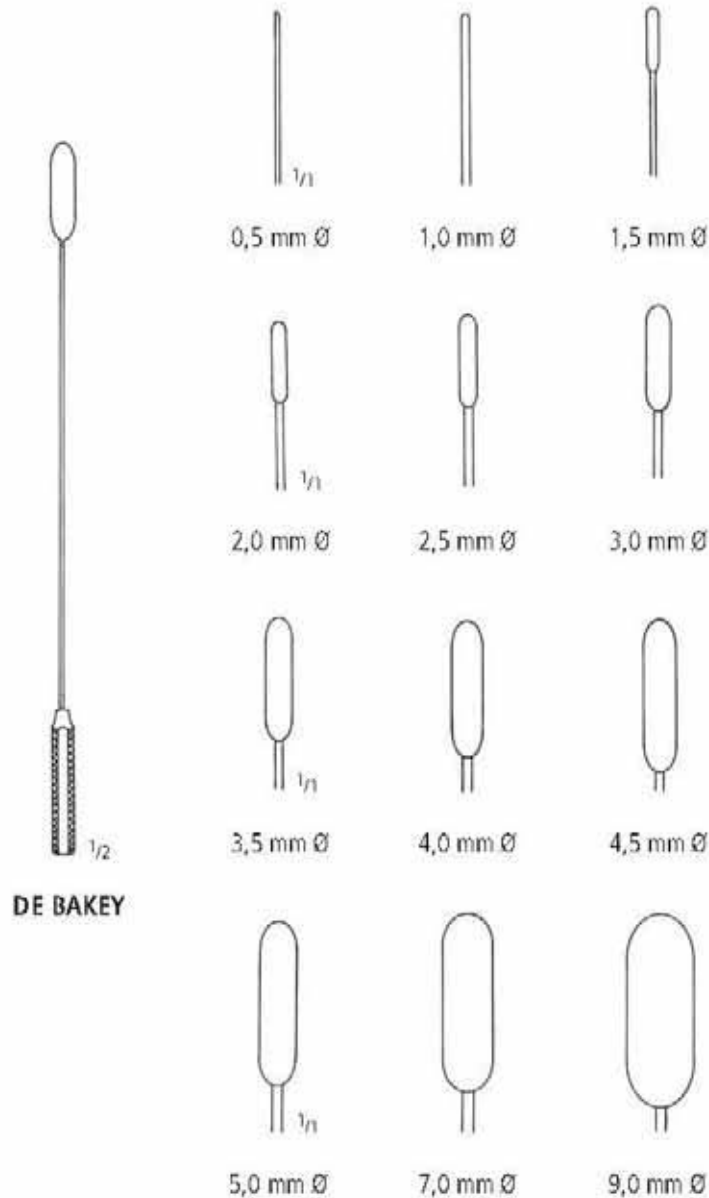

**DE BAKEY**

biegsam-malleable-maleables-malléables-malleabili

mm Ø	19,0 cm / 7 1/2"	35,0 cm / 14"
0,5	AL 200/05	AL 201/05
1,0	AL 200/10	AL 201/10
1,5	AL 200/15	AL 201/15
2,0	AL 200/20	AL 201/20
2,5	AL 200/25	AL 201/25
3,0	AL 200/30	AL 201/30
3,5	AL 200/35	AL 201/35
4,0	AL 200/40	AL 201/40
4,5	AL 200/45	AL 201/45
5,0	AL 200/50	AL 201/50
7,0	AL 200/70	AL 201/70
9,0	AL 200/90	AL 201/90

SONDEN PROBES SONDAS SONDES SONDE

Gefäß Stripper  
 Vascular Strippers  
 Desobliteradores de vasos  
 Tire veines  
 Tiravene



50,0 cm / 20"

○ 1/1  
 2,0 mm  
 AL 220/02

○ 1/1  
 6,0 mm  
 AL 220/06

○ 1/1  
 10,0 mm  
 AL 220/10

○  
 3,0 mm  
 AL 220/03

○  
 7,0 mm  
 AL 220/07

○  
 12,0 mm  
 AL 220/12

○  
 4,0 mm  
 AL 220/04

○  
 8,5 mm  
 AL 220/08

○  
 14,0 mm  
 AL 220/14



AL 222/12  
 12,0 cm / 4 3/4"

AA  
 AB  
 AC  
 AD  
 AE  
 AF  
 AG  
 AH  
 AI  
 AJ  
 AK  
 AL  
 AM  
 AN  
 AO  
 AP  
 AQ  
 AR  
 AS  
 AT  
 AU  
 AV  
 AW  
 AX  
 AY  
 AZ

Fasszangen  
 Grasping forceps  
 Pinzas para coger  
 Pincers pour saisir  
 Pinze per afferrare



**FRANKENFELDT**  
 AL 248/36  
 36,0 cm / 14 1/4"



33,0 cm / 13"



AL 250/33

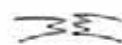

AL 251/33



AL 252/33

---

VERBAND  
DRESSING  
VENDAJES  
PANSEMENTS  
BENDAGGI

**AM**

**nopa**<sup>®</sup> instruments





**HOPKINS**  
AM 030/20  
20,0 cm/8"



**ESMARCH**  
AM 038/18  
18,0 cm/7"



**REINER**  
AM 040/18  
18,5 cm/7 1/8"



**WIGMORE**  
AM 044/19  
19,0 cm/7 1/2"



**ENGEL**  
AM 060/14  
14,0 cm/5 1/2"



**BERGMANN**  
AM 062/18  
18,0 cm/7"





**HENNIG**  
AM 100/28  
28,0 cm/11"



**BEESON**  
AM 102/30  
30,0 cm/12"



**MOD. USA**  
AM 120/23  
23,0 cm/9"

AA  
AB  
AC  
AD  
AE  
AF  
AK  
AL  
**AM**  
AO  
AP  
AR  
KA  
KD  
KU  
KY



**WOLFF**

18,0 cm / 7" AM 200/18  
 24,0 cm / 9<sup>1</sup>/<sub>2</sub>" AM 200/24



**STILLE**

20,0 cm / 8" AM 250/20  
 23,0 cm / 9" AM 250/23  
 26,0 cm / 10<sup>1</sup>/<sub>2</sub>" AM 250/26  
 37,0 cm / 14<sup>1</sup>/<sub>2</sub>" AM 250/37

# OSCI nopa<sup>®</sup>



AM 300/00 = 230 V / 500 W  
 ( + AM 308/50 + AM 308/65 + AM 312/23)  
 Euro-Flachstecker / EU-plug

AM 300/01 = 110 V / 500 W  
 ( + AM 308/50 + AM 308/65 + AM 312/23)  
 USA-Stecker / USA-plug



Für Hartverband  
 För hard plaster  
 Para yeso duro  
 Pour plâtre dur  
 per bendaggi gessati

AM 308/50 = 50 mm Ø  
 AM 308/65 = 65 mm Ø



AM 312/23

## nopa<sup>®</sup> BluePower



- AM 301/00 = 230 V  
 (+ AM 308/50 + AM 308/65 + AM 312/23)  
 Euro-Flachstecker / EU-plug
- AM 301/01 = 120 V  
 (+ AM 308/50 + AM 308/65 + AM 312/23)  
 USA-Stecker / USA-plug



Für Hartverband  
 For hard plaster  
 Para yeso duro  
 Pour plâtre dur  
 per bendaggi gessati

- AM 308/50 = 50 mm Ø  
 AM 308/65 = 65 mm Ø



AM 312/23

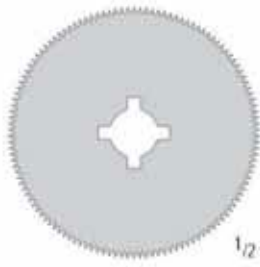

Für Hartverband  
For hard plaster  
Para yeso duro  
Pour plâtre dur  
per bendaggi gessati

AM 308/45 = Ø 45 mm  
AM 308/50 = Ø 50 mm  
AM 308/65 = Ø 65 mm



AM 308/70



AM 308/71 = Ø 65 mm



AM 308/72 = 8 mm



AM 308/73 = 20 mm



AM 308/80

vacu nopa<sup>®</sup> (Absaugung)  
(vacuum cleaner)



AM 350/00 – 230 V  
AM 350/01 – 120 V



PUNKTION/KANÜLEN  
PUNCTURE/SPECIAL NEEDLES  
PUNCION/AGUJAS ESPECIALES  
PONCTION/AIGUILLES SPECIALES  
PUNTURA/AGHI SPECIALI

A0

nopa<sup>®</sup> instruments





Trokare  
Trocars  
Trócares  
Trocarcs  
Trequarti



AO 110/03  
Satz zu 3 Stück  
Set of 3 pieces  
Juego de 3 piezas  
Jeu de 3 pièces  
Serie da 3 pezzi

AO 110/04  
Satz zu 4 Stück  
Set of 4 pieces  
Juego de 4 piezas  
Jeu de 4 pièces  
Serie da 4 pezzi

**SINUSCOPY**

L (mm)	Ø 3,3 mm	Ø 5,0 mm	Ø 5,0 mm
75	AO 080/01		
85		AO 080/10	AO 080/25
110		AO 080/15	

**UNIVERSAL**

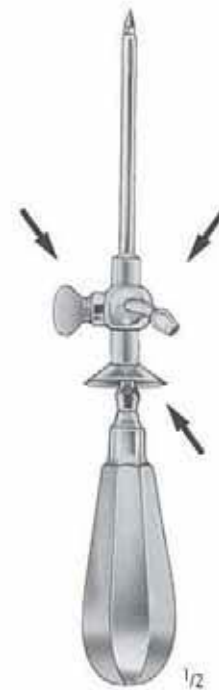

**STANDARD**

Ø 3 mm	AO 120/30
Ø 4 mm	AO 120/40
Ø 5 mm	AO 120/50
Ø 6 mm	AO 120/60

**STANDARD**

AO 122/30
AO 122/40
AO 122/50
AO 122/60

**STANDARD**

AO 124/30
AO 124/40
AO 124/50
AO 124/60

AA  
AB  
AC  
AD  
AE  
AF  
AK  
AL  
AM  
AO  
AP  
AR  
KA  
KD  
KU  
KY

Trokare  
Trocars  
Trocares  
Trocaris  
Trequarti



**NELSON**  
21,0 cm/8 1/4"



Fig. 1  
AO 140/01  
7,5 mm

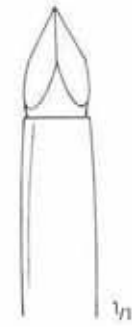

Fig. 2  
AO 140/02  
9,5 mm



Fig. 3  
AO 140/03  
11,0 mm



Fig. 4  
AO 140/04  
12,5 mm



**BUELAU**  
AO 144/00  
24,0 cm/9 1/2"



8,0 mm



1/2



**CAMPBELL**  
AO 148/06  
16,0 cm/6 1/4"



6,0 mm



**CAMPBELL**  
AO 148/08  
16,0 cm/6 1/4"



8,0 mm

Trokare  
Trocars  
Trocares  
Trocartes  
Trequarti

AA  
AB  
AC  
AD  
AE  
AF  
AK  
AL  
AM  
AO  
AP  
AR  
KA  
KD  
KU  
KY



**OCHSNER**  
 Charr. 10 AO 160/10  
 Charr. 12 AO 160/12  
 Charr. 14 AO 160/14  
 Charr. 16 AO 160/16  
 Charr. 18 AO 160/18  
 Charr. 20 AO 160/20



**LANDAU**  
 AO 170/16  
 16,0 cm/6 1/4"  
 2,0 mm



**JOHANSSON**  
 AO 172/00  
 18,0 cm/7"  
 9,0 mm

Trokare  
Trocars  
Trocars  
Trocarts  
Trequarti

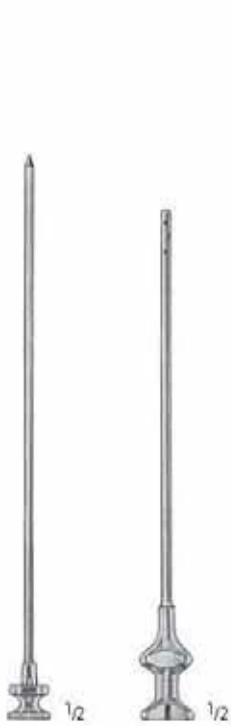

**EICKEN**  
1,8 x 105 mm AO 176/18  
2,0 x 105 mm AO 176/20  
3,0 x 105 mm AO 176/30

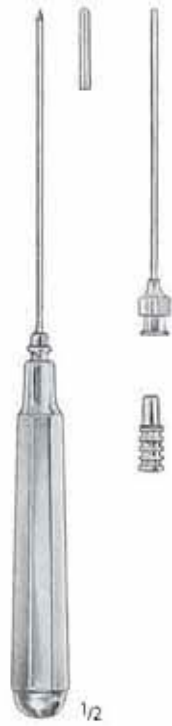

**LICHTWITZ**  
AO 180/00  
1,8 mm



**LICHTWITZ**  
AO 182/00  
1,6 mm



**DOUGLAS**  
AO 185/00  
3,0 mm



**PIERCE**  
AO 190/30 Ø 3,0 mm  
AO 190/40 Ø 4,0 mm  
AO 190/50 Ø 5,0 mm  
Ø 5,5 mm



**KRAUSE**  
AO 194/30  
AO 194/40  
AO 194/50  
AO 194/55

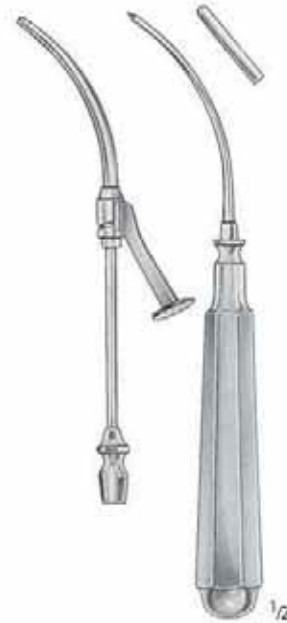

**COAKLEY**  
AO 200/16  
2,25 mm



Saugrohre  
Suction Tubes  
Tubos de aspiración  
Canules d'aspiration  
Cannule per aspirazione

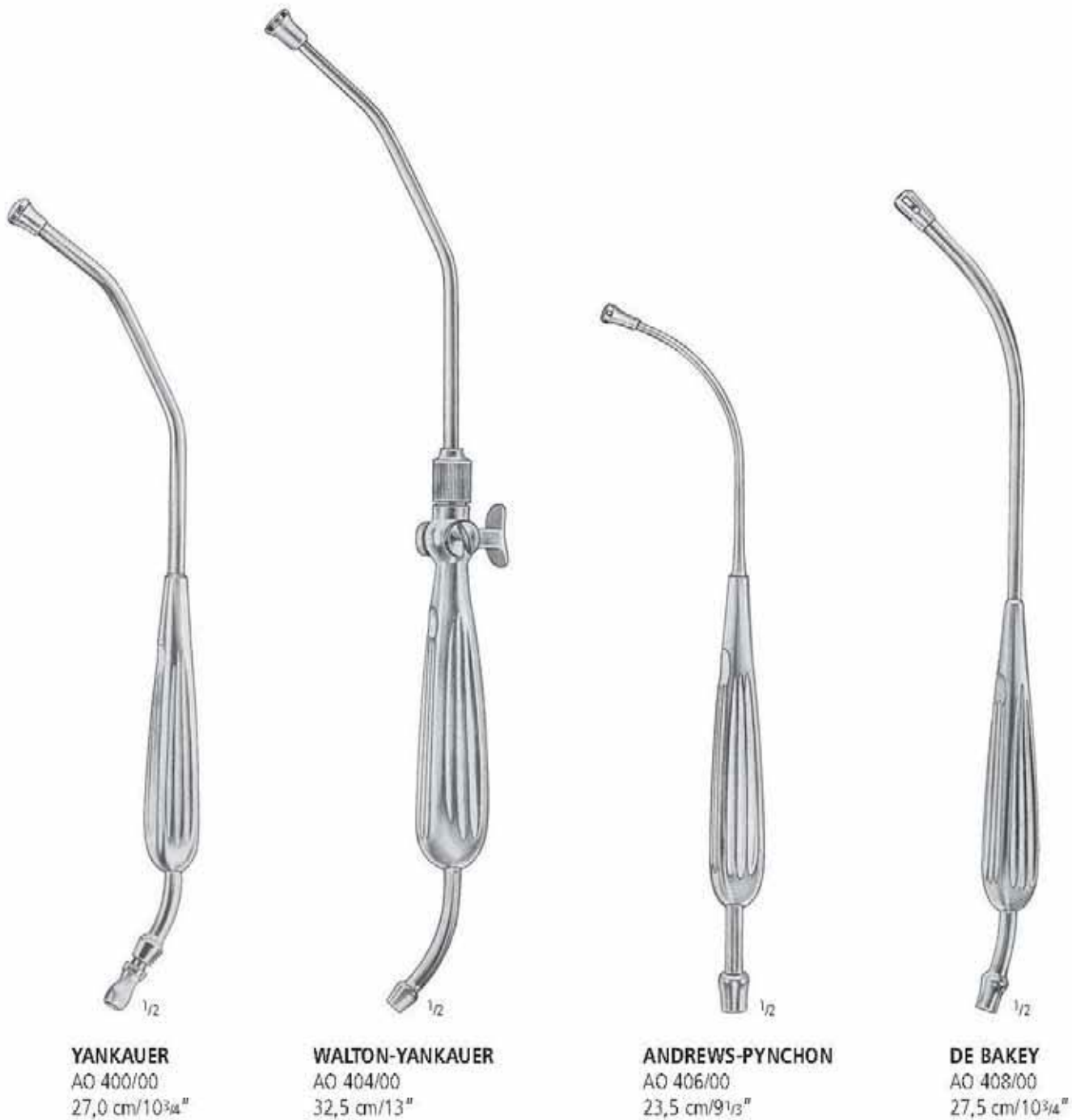

AA  
AB  
AC  
AD  
AE  
AF  
AK  
AL  
AM  
AO  
AP  
AR  
KA  
KD  
KU  
KY

Saugrohre  
Suction Tubes  
Tubos de aspiración  
Canules d'aspiration  
Cannule per aspirazione



**COUPLAND**  
AO 410/00



**BYRD**  
1,5 mm AO 412/15  
2,5 mm AO 412/25  
3,5 mm AO 412/35



**POOLE**  
AO 420/22  
10,0 mm



**POOLE**  
AO 421/22  
8,0 mm



**BABY-POOLE**  
AO 422/20  
5,5 mm

Saugrohre  
Suction Tubes  
Tubos de aspiración  
Canules d'aspiration  
Cannule per aspirazione

8,0 mm



**COOLEY**  
AO 424/01  
33,0 cm/13"

8,0 mm



**COOLEY**  
AO 424/02  
35,0 cm/14"

6,0 mm



**COOLEY**  
AO 424/03  
30,0 cm/12"

10,0 mm



**COOLEY**  
AO 424/04  
31,0 cm/12 1/4"

AA  
AB  
AC  
AD  
AE  
AF  
AK  
AL  
AM  
AO  
AP  
AR  
KA  
KD  
KU  
KY

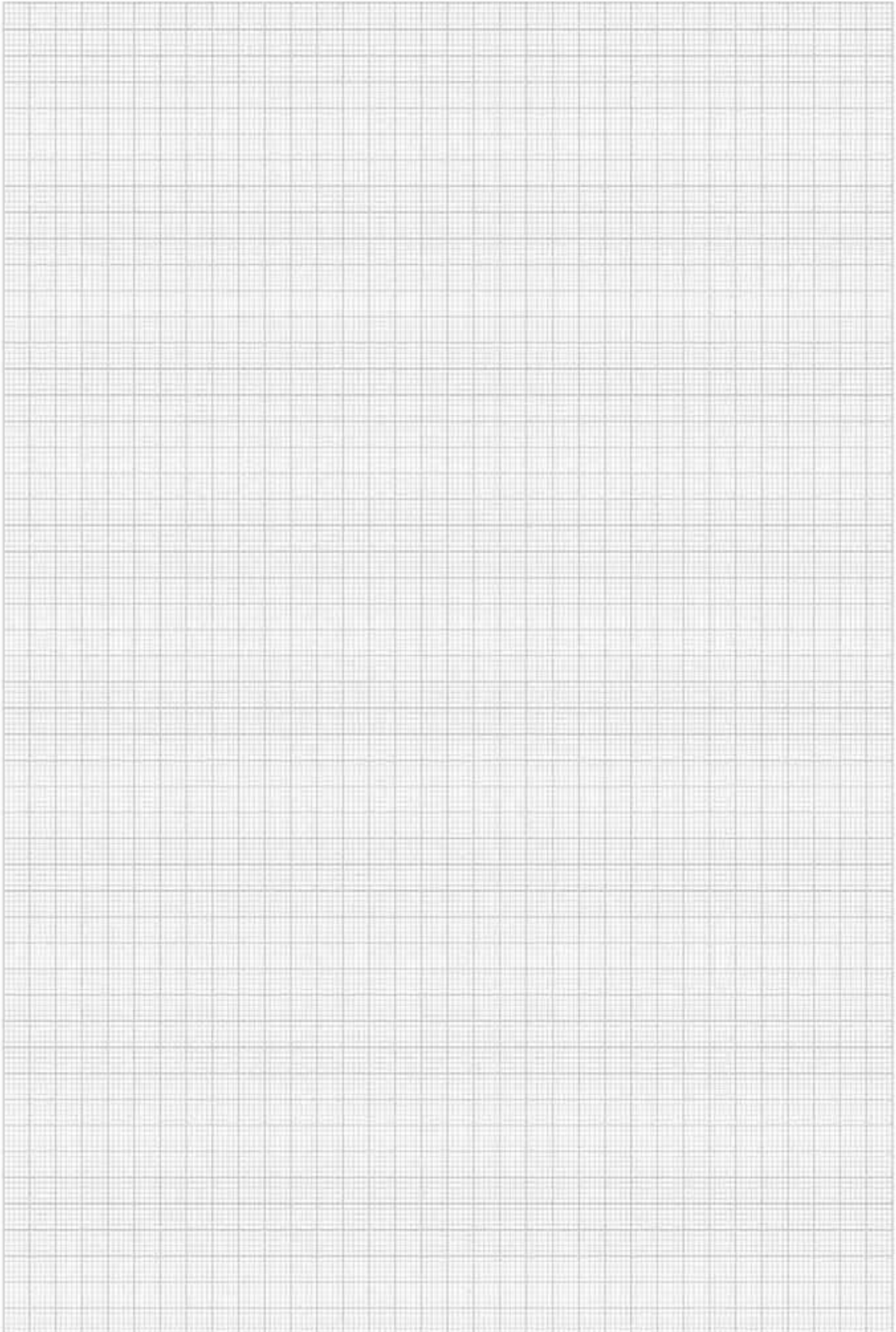



Saugrohre  
Suction Tubes  
Tubos de aspiración  
Canules d'aspiration  
Cannule per aspirazione



complete with suction tube  
+ cannula 0,5 mm  
+ cannula 0,7 mm  
+ cannula 0,9 mm

**FRAZIER**

6 Charr.	AO 430/06
7 Charr.	AO 430/07
8 Charr.	AO 430/08
9 Charr.	AO 430/09
10 Charr.	AO 430/10
11 Charr.	AO 430/11
12 Charr.	AO 430/12

**PLESTER**

1,5 mm	AO 432/15
2,0 mm	AO 432/20
2,5 mm	AO 432/25
3,0 mm	AO 432/30

**FERGUSSON**

5 Charr.	AO 434/05
6 Charr.	AO 434/06
7 Charr.	AO 434/07
8 Charr.	AO 434/08
9 Charr.	AO 434/09
10 Charr.	AO 434/10
12 Charr.	AO 434/12

**EICKEN-KILLIAN**

AO 436/03  
13,0 cm/5"  
Ø 3 mm

**WULLSTEIN MICRO**

AO 438/00

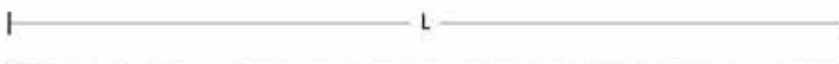

	L	L	L	L
	130 mm	150 mm	180 mm	220 mm
Ø 1,5 mm	AO 440/13	AO 440/15	AO 440/18	AO 440/22
Ø 2,0 mm	AO 441/13	AO 441/15	AO 441/18	AO 441/22
Ø 2,5 mm	AO 442/13	AO 442/15	AO 442/18	AO 442/22
Ø 3,5 mm	AO 443/13	AO 443/15	AO 443/18	AO 443/22



**ADSON**  
AO 450/04  
21,0 cm/8<sup>1</sup>/<sub>4</sub>"  
Ø 4,0 mm

AA  
AB  
AC  
AD  
AE  
AF  
AK  
AL  
AM  
AO  
AP  
AR  
KA  
KD  
KU  
KY

Saugrohre  
Suction Tubes  
Tubos de aspiración  
Canules d'aspiration  
Cannule per aspirazione



**COGSWELL**  
AO 460/20  
24,5 cm/9<sup>3</sup>/<sub>4</sub>"  
2,0 mm Ø



**LUER**  
L = 110 mm



AO 461/30  
Ø 3,0 mm



AO 461/35  
Ø 3,5 mm

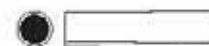

AO 461/45  
Ø 4,5 mm



Saugrohre  
Suction Tubes  
Tubos de aspiración  
Canules d'aspiration  
Cannule per aspirazione



Länge/length	A=Ø 3,0 mm	A=Ø 4,0 mm	A=Ø 6,0 mm
14,0 cm	AO 463/03	AO 463/04	AO 463/06
18,0 cm	AO 464/03	AO 464/04	AO 464/06

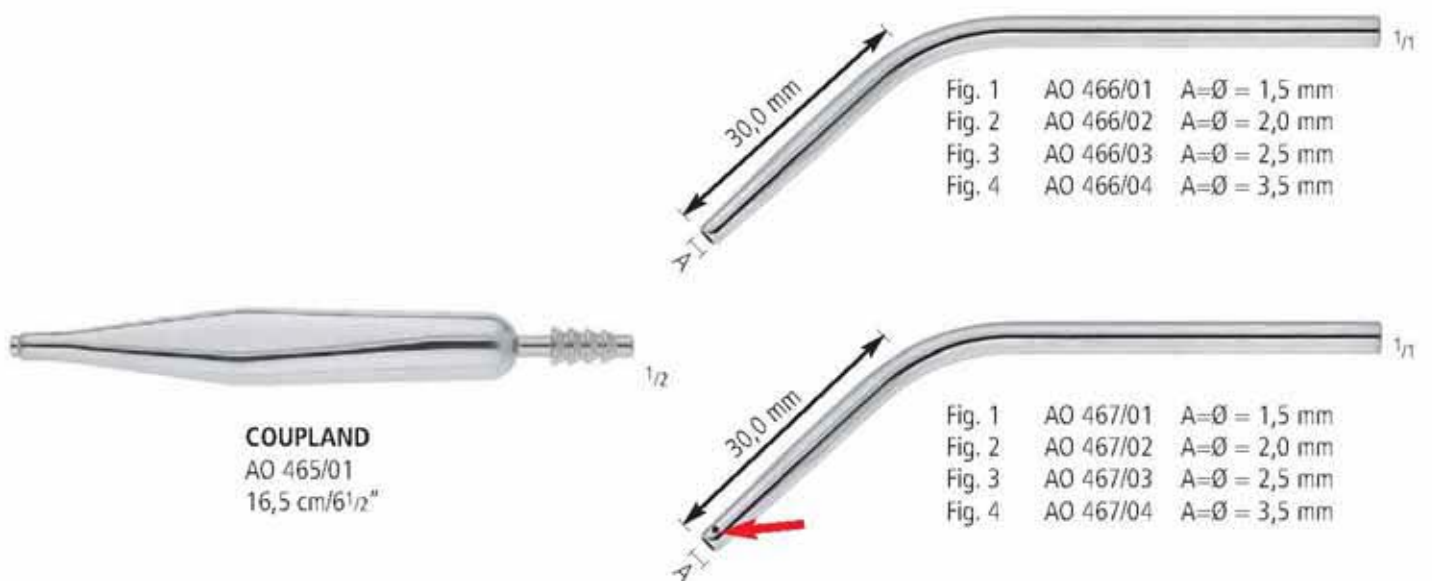

**COUPLAND**  
AO 465/01  
16,5 cm/6 1/2"

- Fig. 1 AO 466/01 A=Ø = 1,5 mm
- Fig. 2 AO 466/02 A=Ø = 2,0 mm
- Fig. 3 AO 466/03 A=Ø = 2,5 mm
- Fig. 4 AO 466/04 A=Ø = 3,5 mm

- Fig. 1 AO 467/01 A=Ø = 1,5 mm
- Fig. 2 AO 467/02 A=Ø = 2,0 mm
- Fig. 3 AO 467/03 A=Ø = 2,5 mm
- Fig. 4 AO 467/04 A=Ø = 3,5 mm

AA  
AB  
AC  
AD  
AE  
AF  
AK  
AL  
AM  
AO  
AP  
AR  
KA  
KD  
KU  
KY

Handgriffe für Liposuktions- und Infiltrationskanülen mit Luer-Lock Ansatz  
 Handles for liposuction and infiltration cannulae with Luer-Lock connection  
 Mangos para cánulas de liposucción y infiltración con empalme Luer-Lock  
 Manches pour canules de liposuction et infiltration avec embout Luer-Lock  
 Manici per cannule di liposuzione e infiltrazione con attacco Luer-Lock



AO 501/01



AO 501/02





AO 501/03

Liposuktions- und Infiltrationskanülen mit Luer-Lock Ansatz  
 Liposuction and infiltration cannulae with Luer-Lock connection  
 Cánulas de liposucción y infiltración con empalme Luer-Lock  
 Canules de liposucción et infiltration avec avec embout Luer-Lock  
 Cannule di liposuzione e infiltrazione con attacco Luer-Lock





	Länge / length	150 mm	200 mm	250 mm	300 mm
 MONOPORT	Ø 2 mm	AO 505/01	AO 505/02	AO 505/03	AO 505/04
	Ø 3 mm	AO 505/05	AO 505/06	AO 505/07	AO 505/08
	Ø 4 mm	AO 505/09	AO 505/10	AO 505/11	AO 505/12
	Ø 5 mm	AO 505/13	AO 505/14	AO 505/15	AO 505/16

	Länge / length	150 mm	200 mm	250 mm	300 mm
 TRIPORT	Ø 2 mm	AO 506/01	AO 506/02	AO 506/03	AO 506/04
	Ø 3 mm	AO 506/05	AO 506/06	AO 506/07	AO 506/08
	Ø 4 mm	AO 506/09	AO 506/10	AO 506/11	AO 506/12
	Ø 5 mm	AO 506/13	AO 506/14	AO 506/15	AO 506/16

	Länge / length	150 mm	200 mm	250 mm	300 mm
 MERCEDES	Ø 2 mm	AO 507/01	AO 507/02	AO 507/03	AO 507/04
	Ø 3 mm	AO 507/05	AO 507/06	AO 507/07	AO 507/08
	Ø 4 mm	AO 507/09	AO 507/10	AO 507/11	AO 507/12
	Ø 5 mm	AO 507/13	AO 507/14	AO 507/15	AO 507/16

	Länge / length	150 mm	200 mm	250 mm	300 mm
 SPIRALE	Ø 2 mm	AO 508/01	AO 508/02	AO 508/03	AO 508/04
	Ø 3 mm	AO 508/05	AO 508/06	AO 508/07	AO 508/08
	Ø 4 mm	AO 508/09	AO 508/10	AO 508/11	AO 508/12
	Ø 5 mm	AO 508/13	AO 508/14	AO 508/15	AO 508/16

	Länge / length	150 mm	200 mm	250 mm	300 mm
 SHARK	Ø 2 mm	AO 509/01	AO 509/02	AO 509/03	AO 509/04
	Ø 3 mm	AO 509/05	AO 509/06	AO 509/07	AO 509/08
	Ø 4 mm	AO 509/09	AO 509/10	AO 509/11	AO 509/12
	Ø 5 mm	AO 509/13	AO 509/14	AO 509/15	AO 509/16

	Länge / length	150 mm	200 mm	250 mm	300 mm
 COBRA	Ø 2 mm	AO 510/01	AO 510/02	AO 510/03	AO 510/04
	Ø 3 mm	AO 510/05	AO 510/06	AO 510/07	AO 510/08
	Ø 4 mm	AO 510/09	AO 510/10	AO 510/11	AO 510/12
	Ø 5 mm	AO 510/13	AO 510/14	AO 510/15	AO 510/16

AA  
AB  
AC  
AD  
AE  
AF  
AG  
AH  
AI  
AJ  
AK  
AL  
AM  
AN  
AO  
AP  
AQ  
AR  
AS  
AT  
AU  
AV  
AW  
AX  
AY  
AZ

AO

Handgriffe für Liposuktions- und Infiltrationskanülen mit Schnellverriegelung  
 Handles for liposuction and infiltration cannulae with quick connector  
 Mangos para cánulas de liposucción y infiltración con aseguramiento rápido  
 Manches pour canules de liposuction et infiltration avec raccordement rapide  
 Manici per cannule di liposuzione e infiltrazione con chiusura rapida



AO 501/11



AO 501/12



AO 501/13



Liposuktions- und Infiltrationskanülen mit Schnellverriegelung  
 Liposuction and infiltration cannulae with quick connector  
 Cánulas de liposucción y infiltración con aseguramiento rápido  
 Canules de liposuction et infiltration avec raccordement rapide  
 Cannule di liposuzione e infiltrazione con chiusura rapida



	Länge / length	150 mm	200 mm	250 mm	300 mm
<p><b>MONOPORT</b></p>	Ø 2 mm	AO 515/01	AO 515/02	AO 515/03	AO 515/04
	Ø 3 mm	AO 515/05	AO 515/06	AO 515/07	AO 515/08
	Ø 4 mm	AO 515/09	AO 515/10	AO 515/11	AO 515/12
	Ø 5 mm	AO 515/13	AO 515/14	AO 515/15	AO 515/16

	Länge / length	150 mm	200 mm	250 mm	300 mm
<p><b>TRIPORT</b></p>	Ø 2 mm	AO 516/01	AO 516/02	AO 516/03	AO 516/04
	Ø 3 mm	AO 516/05	AO 516/06	AO 516/07	AO 516/08
	Ø 4 mm	AO 516/09	AO 516/10	AO 516/11	AO 516/12
	Ø 5 mm	AO 516/13	AO 516/14	AO 516/15	AO 516/16

	Länge / length	150 mm	200 mm	250 mm	300 mm
<p><b>MERCEDES</b></p>	Ø 2 mm	AO 517/01	AO 517/02	AO 517/03	AO 517/04
	Ø 3 mm	AO 517/05	AO 517/06	AO 517/07	AO 517/08
	Ø 4 mm	AO 517/09	AO 517/10	AO 517/11	AO 517/12
	Ø 5 mm	AO 517/13	AO 517/14	AO 517/15	AO 517/16

	Länge / length	150 mm	200 mm	250 mm	300 mm
<p><b>SPIRALE</b></p>	Ø 2 mm	AO 518/01	AO 518/02	AO 518/03	AO 518/04
	Ø 3 mm	AO 518/05	AO 518/06	AO 518/07	AO 518/08
	Ø 4 mm	AO 518/09	AO 518/10	AO 518/11	AO 518/12
	Ø 5 mm	AO 518/13	AO 518/14	AO 518/15	AO 518/16

	Länge / length	150 mm	200 mm	250 mm	300 mm
<p><b>SHARK</b></p>	Ø 2 mm	AO 519/01	AO 519/02	AO 519/03	AO 519/04
	Ø 3 mm	AO 519/05	AO 519/06	AO 519/07	AO 519/08
	Ø 4 mm	AO 519/09	AO 519/10	AO 519/11	AO 519/12
	Ø 5 mm	AO 519/13	AO 519/14	AO 519/15	AO 519/16

	Länge / length	150 mm	200 mm	250 mm	300 mm
<p><b>COBRA</b></p>	Ø 2 mm	AO 520/01	AO 520/02	AO 520/03	AO 520/04
	Ø 3 mm	AO 520/05	AO 520/06	AO 520/07	AO 520/08
	Ø 4 mm	AO 520/09	AO 520/10	AO 520/11	AO 520/12
	Ø 5 mm	AO 520/13	AO 520/14	AO 520/15	AO 520/16

AA  
AB  
AC  
AD  
AE  
AF  
AK  
AL  
AM  
AO  
AP  
AR  
KA  
KD  
KU  
KY



Liposuktions- und Infiltrationskanülen mit festem Handgriff  
 Liposuction and infiltration cannulae with fixed handle  
 Cánulas de liposucción y infiltración con mango fijo  
 Canules de liposucción et infiltration avec manche arrêté  
 Cannule di liposuzione e infiltrazione con manico fisso



Länge / length	150 mm	200 mm	250 mm	300 mm
Ø 2 mm	AO 525/01	AO 525/02	AO 525/03	AO 525/04
Ø 3 mm	AO 525/05	AO 525/06	AO 525/07	AO 525/08
Ø 4 mm	AO 525/09	AO 525/10	AO 525/11	AO 525/12
Ø 5 mm	AO 525/13	AO 525/14	AO 525/15	AO 525/16



Länge / length	150 mm	200 mm	250 mm	300 mm
Ø 2 mm	AO 526/01	AO 526/02	AO 526/03	AO 526/04
Ø 3 mm	AO 526/05	AO 526/06	AO 526/07	AO 526/08
Ø 4 mm	AO 526/09	AO 526/10	AO 526/11	AO 526/12
Ø 5 mm	AO 526/13	AO 526/14	AO 526/15	AO 526/16



Länge / length	150 mm	200 mm	250 mm	300 mm
Ø 2 mm	AO 527/01	AO 527/02	AO 527/03	AO 527/04
Ø 3 mm	AO 527/05	AO 527/06	AO 527/07	AO 527/08
Ø 4 mm	AO 527/09	AO 527/10	AO 527/11	AO 527/12
Ø 5 mm	AO 527/13	AO 527/14	AO 527/15	AO 527/16



Länge / length	150 mm	200 mm	250 mm	300 mm
Ø 2 mm	AO 528/01	AO 528/02	AO 528/03	AO 528/04
Ø 3 mm	AO 528/05	AO 528/06	AO 528/07	AO 528/08
Ø 4 mm	AO 528/09	AO 528/10	AO 528/11	AO 528/12
Ø 5 mm	AO 528/13	AO 528/14	AO 528/15	AO 528/16

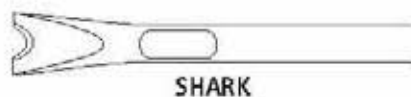

Länge / length	150 mm	200 mm	250 mm	300 mm
Ø 2 mm	AO 529/01	AO 529/02	AO 529/03	AO 529/04
Ø 3 mm	AO 529/05	AO 529/06	AO 529/07	AO 529/08
Ø 4 mm	AO 529/09	AO 529/10	AO 529/11	AO 529/12
Ø 5 mm	AO 529/13	AO 529/14	AO 529/15	AO 529/16

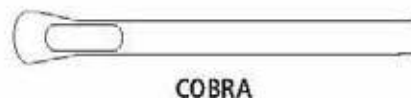

Länge / length	150 mm	200 mm	250 mm	300 mm
Ø 2 mm	AO 530/01	AO 530/02	AO 530/03	AO 530/04
Ø 3 mm	AO 530/05	AO 530/06	AO 530/07	AO 530/08
Ø 4 mm	AO 530/09	AO 530/10	AO 530/11	AO 530/12
Ø 5 mm	AO 530/13	AO 530/14	AO 530/15	AO 530/16



Biopsie-Kanülen  
 Biopsy Needles  
 Aguja para biopsia  
 Aiguilles à biopsie  
 Aghi per biopsia



**SALAH**  
 AO 630/16  
 1,6 x 50 mm



**KLIMA-ROSSEGER**  
 AO 660/18  
 1,8 x 35 mm



AA  
 AB  
 AC  
 AD  
 AE  
 AF  
 AK  
 AL  
 AM  
**AO**  
 AP  
 AR  
 KA  
 KD  
 KU  
 KY

Biopsie-Kanülen  
Biopsy Needles  
Agujas para biopsia  
Aiguilles à biopsie  
Aghi per biopsia



**TUOHY**

- 1,2 x 80 mm AO 690/16
- 1,4 x 80 mm AO 690/17
- 1,6 x 80 mm AO 690/18



**TROCAR**

- Ø 1,4 mm AO 718/14
- Ø 1,8 mm AO 718/18



**MENGHINI**

- 1,0 x 35 mm AO 715/01
- 1,0 x 70 mm AO 715/02
- 1,2 x 70 mm AO 715/03
- 1,2 x 100 mm AO 715/04
- 1,4 x 70 mm AO 715/05
- 1,4 x 100 mm AO 715/06
- 1,6 x 70 mm AO 715/07
- 1,8 x 100 mm AO 715/08



**QUINKE**

- 0,7 x 76 mm AO 720/01
- 0,7 x 89 mm AO 720/02
- 1,0 x 76 mm AO 720/03
- 1,0 x 89 mm AO 720/04
- 1,2 x 76 mm AO 720/05
- 1,2 x 89 mm AO 720/06



**MENGHINI**

- 1,4 x 168 mm AO 717/14
- 1,8 x 168 mm AO 717/18



- AO 722/00
- 2,0 x 220 mm
- Arteriographie-Kanüle
- Arteriography needle
- Aguja de arteriografía
- Aiguilles pour artériographie
- Aghi per arteriografia

Spezialkanülen  
Special Needles  
Agujas especiales  
Aiguilles spéciales  
Aghi speciali



SCHMID



3,0 mm  
AO 740/03



4,0 mm  
AO 740/04



5,0 mm  
AO 740/05



6,0 mm  
AO 740/06



IOWA  
AO 750/14  
14,0 cm/5 1/2"



VERRES

- 1,55 x 55 mm AO 780/05
- 2,00 x 100 mm AO 780/10
- 2,00 x 120 mm AO 780/12
- 2,00 x 150 mm AO 780/15

AA  
AB  
AC  
AD  
AE  
AF  
AK  
AL  
AM  
AO  
AP  
AR  
KA  
KD  
KU  
KY

Führungsnadeln  
 Guide Needles  
 Aguja de guía  
 Aiguilles d'introduction  
 Aghi per introduzione



**Charr./Fr.**

8 AO 820/08  
 10 AO 820/10  
 12 AO 820/12  
 14 AO 820/14  
 16 AO 820/16  
 18 AO 820/18

AO 821/08  
 AO 821/10  
 AO 821/12  
 AO 821/14  
 AO 821/16  
 AO 821/18

AO 822/08  
 AO 822/10  
 AO 822/12  
 AO 822/14  
 AO 822/16  
 AO 822/18

Ampullenspritzen  
Cartridge Syringes  
Jeringas para cartucho ampollas  
Seringues à ampoule  
Siringhe fiali



mit Aspiration  
with aspiration  
con aspiración  
avec aspiration  
con aspirazione

AO 861/18  
1,8 ml



ohne Aspiration  
without aspiration  
sin aspiración  
sans aspiration  
senza aspirazione

AO 862/18  
1,8 ml

*stainless*



mit Aspiration  
with aspiration  
con aspiración  
avec aspiration  
con aspirazione

AO 865/18  
1,8 ml



AO 866/18  
1,8 ml

AA  
AB  
AC  
AD  
AE  
AF  
AK  
AL  
AM  
AO  
AP  
AR  
KA  
KD  
KU  
KY

Spritzen  
Syringes  
Jeringas  
Seringues  
Siringhe



Glasspritze  
50 ml AO 869/05

**JANET**  
50 ml AO 870/05  
100 ml AO 870/10  
150 ml AO 870/15  
200 ml AO 870/20



50 ml AO 871/05  
100 ml AO 871/10  
150 ml AO 871/15  
200 ml AO 871/20



Einwegspritze  
20 ml AO 875/02  
60 ml AO 875/06



Hähne und Verbindungsstücke  
 Stopcocks and Connecting Pieces  
 Llaves y Piezas de conexión  
 Robinets et Raccords  
 Rubinetti e Raccordi



AO 910/00



AO 911/00



AO 912/00



AO 913/00



AO 915/00



AO 916/00



AO 917/00



AO 918/00



AO 920/00

links  
 left  
 izquierda  
 gauche  
 sinistra

AO 921/01



AO 921/02

rechts  
 right  
 derecha  
 droite  
 destra



AO 922/00



AO 923/00



AO 924/00



AO 925/00

AA  
 AB  
 AC  
 AD  
 AE  
 AF  
 AG  
 AH  
 AI  
 AJ  
 AK  
 AL  
 AM  
**AO**  
 AP  
 AQ  
 AR  
 AS  
 AT  
 AU  
 AV  
 AW  
 AX  
 AY  
 AZ



---

NARKOSE  
ANAESTHESIA  
ANESTESIA  
ANESTHESIE  
ANESTESIA

AP

nopa<sup>®</sup> instruments





Laryngoskope  
Laryngoscopes  
Laringoscopios  
Laryngoscopes  
Laringoscopi



AP 252/00  
Fig. 0, 55 mm



AP 252/01  
Fig. 1, 75 mm



AP 252/02  
Fig. 2, 90 mm



AP 252/03  
Fig. 3, 110 mm



AP 252/04  
Fig. 4, 135 mm

## McINTOSH



AP 250/00 (90 mm + 110 mm + 135 mm)

AP 250/01 (75 mm + 90 mm + 110 mm + 135 mm)

komplett - complete - completo - complet - completo

AA  
AB  
AC  
AD  
AE  
AF  
AK  
AL  
AM  
AO  
AP  
AR  
KA  
KD  
KU  
KY

Laryngoskope  
Laryngoscopes  
Laringoscopios  
Laryngoscopes  
Laringoscopi



AP 262/00  
Fig. 0, 70 mm



AP 262/01  
Fig. 1, 95 mm



AP 262/02  
Fig. 2, 110 mm



AP 262/03  
Fig. 3, 140 mm



AP 262/04  
Fig. 4, 170 mm



## FOREGGER (WISCONSIN)



AP 260/00 (110 mm + 140 mm + 170 mm)

AP 260/01 (95 mm + 110 mm + 140 mm + 170 mm)

komplett - complete - completo - complet - completo



Laryngoskope  
Laryngoscopes  
Laringoscopios  
Laryngoscopes  
Laringoscoopi



AP 272/00  
Fig. 0, 55 mm



AP 272/01  
Fig. 1, 80 mm



AP 272/02  
Fig. 2, 130 mm



AP 272/03  
Fig. 3, 170 mm



AP 272/04  
Fig. 4, 180 mm



## MILLER



AP 270/00 (130 mm + 170 mm + 180 mm)

AP 270/01 (80 mm + 130 mm + 170 mm + 180 mm)

komplett - complete - completo - complet - completo

AA  
AB  
AC  
AD  
AE  
AF  
AK  
AL  
AM  
AO  
AP  
AR  
KA  
KD  
KU  
KY

Laryngoskope  
Laryngoscopes  
Laringoscopios  
Laryngoscopes  
Laringoscopi



AP 280/19  
Ø 19 mm



AP 280/28  
Ø 28 mm



AP 280/37  
Ø 37 mm



AP 282/00  
Fig. 2-4



AP 284/00  
Fig. 0-1

Kaltlicht Laryngoskope  
 Fibre Optic Laryngoscopes  
 Laringoscopios con luz fría  
 Laryngoscopes à lumière froide  
 Laringoscopi a luce fredda

## McINTOSH FIBRE OPTIC



AP 300/00 (80 mm + 105 mm + 130 mm)  
 AP 300/01 (70 mm + 80 mm + 105 mm + 130 mm)

komplett - complete - completo - complet - completo



Fig. 0,	55 mm	AP 302/00
Fig. 1,	70 mm	AP 302/01
Fig. 2,	80 mm	AP 302/02
Fig. 3,	105 mm	AP 302/03
Fig. 4,	130 mm	AP 302/04

AA  
AB  
AC  
AD  
AE  
AF  
AK  
AL  
AM  
AO  
AP  
AR  
KA  
KD  
KU  
KY

Kaltlicht Laryngoskope  
 Fibre Optic Laryngoscopes  
 Laringoscopios con luz fría  
 Laryngoscopes à lumière froide  
 Laringoscopi a luce fredda

## FOREGGER (WISCONSIN) FIBRE OPTIC



AP 310/00 (110 mm + 140 mm + 170 mm)  
 AP 310/01 (95 mm + 110 mm + 140 mm + 170 mm)

komplett - complete - completo - complet - completo



Fig. 0,	70 mm	AP 312/00
Fig. 1,	95 mm	AP 312/01
Fig. 2,	110 mm	AP 312/02
Fig. 3,	140 mm	AP 312/03
Fig. 4,	170 mm	AP 312/04



Kaltlicht Laryngoskope  
 Fibre Optic Laryngoscopes  
 Laringoscopios con luz fría  
 Laryngoscopes à lumière froide  
 Laringoscopi a luce fredda

## MILLER FIBRE OPTIC



AP 320/00 (80 mm + 130 mm + 170 mm)  
 AP 320/01 (80 mm + 130 mm + 170 mm + 180 mm)

komplett - complete - completo - complet - completo



Fig. 0,	55 mm	AP 322/00
Fig. 1,	80 mm	AP 322/01
Fig. 2,	130 mm	AP 322/02
Fig. 3,	170 mm	AP 322/03
Fig. 4,	180 mm	AP 322/04

AA  
AB  
AC  
AD  
AE  
AF  
AK  
AL  
AM  
AO  
AP  
AR  
KA  
KD  
KU  
KY

Kaltlicht Laryngoskope  
 Fibre Optic Laryngoscopes  
 Laringoscopios con luz fría  
 Laryngoscopes à lumière froide  
 Laringoscopi a luce fredda

## FIBRE OPTIC



AP 340/00  
 Ø 30 mm



AP 341/00  
 Ø 20 mm



AP 345/01  
 2,5 V  
 Halogen



AP 345/02  
 2,5 V  
 Krypton



Katheterzangen  
Catheter forceps  
Pinzas para catéteres  
Pincas pour sondes  
Pinze per cannule



**MAGILL**  
AP 410/16  
16,0 cm/6<sup>1</sup>/<sub>4</sub>"



**MAGILL**  
AP 410/20  
20,0 cm/8"



**MAGILL**  
AP 410/25  
25,0 cm/10"

AA  
AB  
AC  
AD  
AE  
AF  
AK  
AL  
AM  
AO  
AP  
AR  
KA  
KD  
KU  
KY

Anschluss Richard Wolf, Adapter oder andere Anschlüsse auf Wunsch  
 Richard Wolf connector, adaptor or other connectors on request  
 Conector Richard Wolf, adaptador o otros conectores diferentes sobre pedido  
 Connection Richard Wolf, adaptateur ou d'autres embouts à la demande  
 Connettore Richard Wolf, adattatori ed altri connettori su richiesta

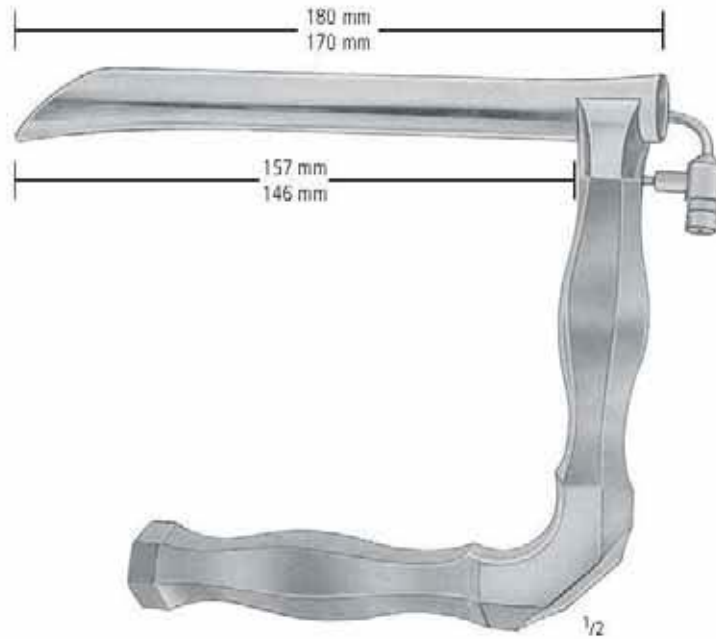

**HOLINGER**

157 mm = AP 455/01

146 mm = AP 455/02

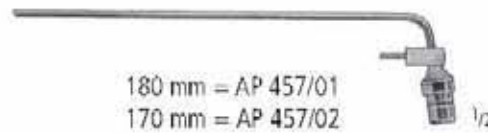

180 mm = AP 457/01

170 mm = AP 457/02

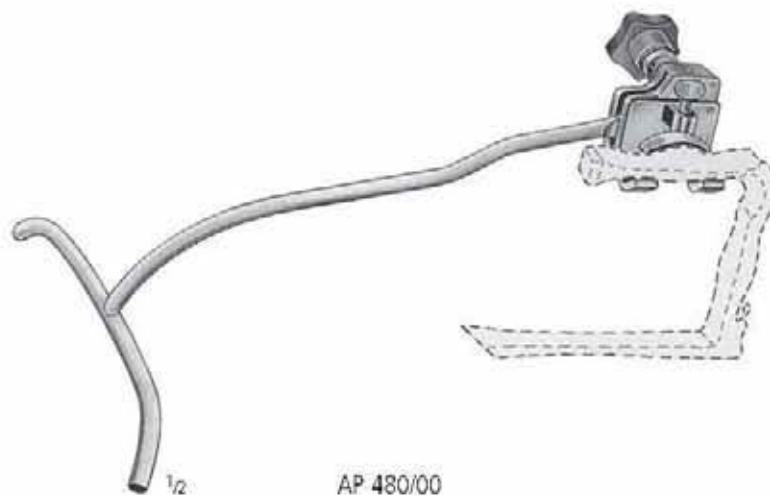

AP 480/00

Kaltlicht Laryngoskope  
 Fibre Optic Laryngoscopes  
 Laringoscopios con luz fría  
 Laryngoscopes à lumière froide  
 Laringoscopi a luce fredda

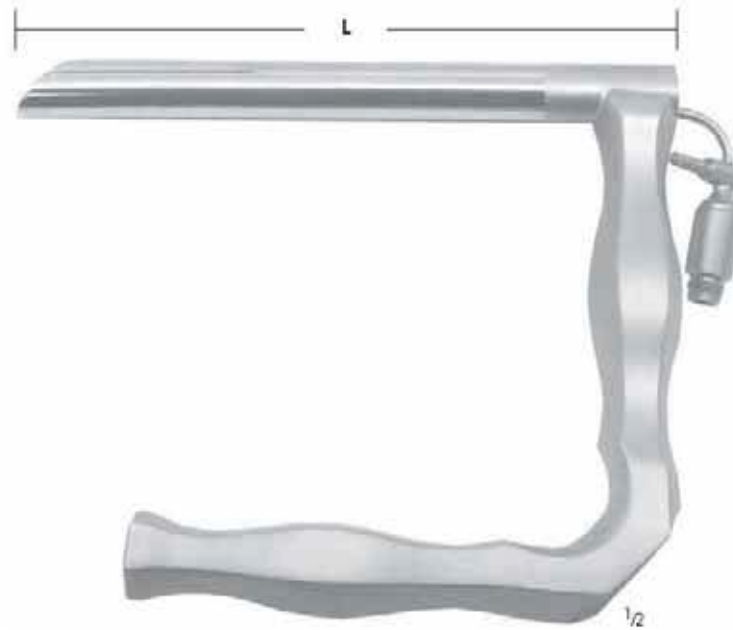

**JACKSON**

- L = 120 mm = AP 465/12
- L = 160 mm = AP 465/16
- L = 180 mm = AP 465/18



- 120 mm = AP 470/12
- 160 mm = AP 470/16
- 180 mm = AP 470/18

AA  
AB  
AC  
AD  
AE  
AF  
AK  
AL  
AM  
AO  
AP  
AR  
KA  
KD  
KU  
KY



---

DIAGNOSTIK  
DIAGNOSTICS  
DIAGNOSTICO  
DIAGNOSTIC  
DIAGNOSTICA

**AR**

**nopa**<sup>®</sup> instruments







Stimspiegel  
 Head Mirrors  
 Espejos frontales  
 Miroirs frontaux  
 Specchi frontali

AA  
 AB  
 AC  
 AD  
 AE  
 AF  
 AK  
 AL  
 AM  
 AO  
 AP  
 AR  
 KA  
 KD  
 KU  
 KY



**LED 4 x AAA**  
 AR 090/00



90 mm = AR 102/09  
 100 mm = AR 102/10

1/2

Stirnlampen  
 Head Lamps  
 Lámparas frontales  
 Eclairage frontaux  
 Lampade frontali



**CLAR 55**  
 AR 150/55  
 6 V



**CLAR STANDARD**  
 AR 160/00  
 6 V

Perkussionshämmer  
Percussion Hammers  
Martillos de percusión  
Marteaux-percuteurs  
Martelli percussori



**BUCK**  
AR 200/18  
18,0 cm/7"

**BABINSKY**  
AR 205/22  
22,0 cm/8<sup>3</sup>/<sub>4</sub>"  
Ø 40 mm

**RABINER**  
AR 208/23  
23,0 cm/9"  
Ø 40 mm

**TAYLOR**  
18,0 cm/7" AR 215/18  
20,0 cm/8" AR 215/20

AA  
AB  
AC  
AD  
AE  
AF  
AK  
AL  
AM  
AO  
AP  
AR  
KA  
KD  
KU  
KY

Perkussionshämmer  
 Percussion Hammers  
 Martillos de percusión  
 Marteaux-percuteurs  
 Martelli percussion



**TROEMNER**  
 AR 216/24  
 24,0 cm/9<sup>1</sup>/<sub>2</sub>"



**DÉJERINE**  
 AR 217/20  
 20,0 cm/8"



**DÉJERINE**  
 AR 218/20  
 20,0 cm/8"

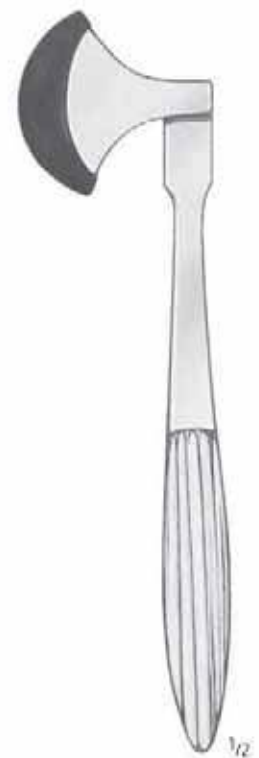

**BERLINER**  
 AR 220/20  
 20,0 cm/8"

Messinstrumente  
 Measuring instruments  
 Instrumentos para medidas  
 Instruments pour mesurer  
 Strumenti per misurare



- 15,0 cm/6" AR 250/15
- 20,0 cm/8" AR 250/20
- 30,0 cm/12" AR 250/30
- 50,0 cm/20" AR 250/50



AR 251/01  
 0-80 mm



AR 251/02  
 0-60 mm

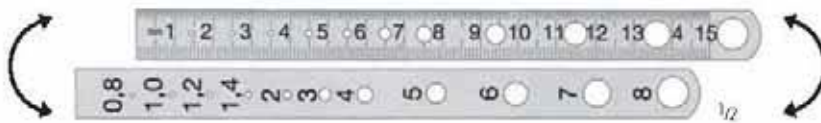

AR 255/15  
 150 mm

Messbereich und Lochlehre  
 measuring range and hole gauge  
 alcance de medición y calibre de agujeros  
 pour mesurer et calibre avec trous  
 per misurare fino e calibro forato



AR 256/15



AR 258/50  
 50,0 cm/20" röntgenfähig  
 x-ray  
 rayos x  
 rayons x  
 raggi x

AA  
 AB  
 AC  
 AD  
 AE  
 AF  
 AK  
 AL  
 AM  
 AO  
 AP  
 AR  
 KA  
 KD  
 KU  
 KY



**VERNIER**  
AR 260/12  
0 - 120 mm



AR 260/18  
0 - 200 mm / 0 - 8 inch



**JAMESON**  
AR 261/08  
0-80 mm / 0-3 inch



**THORPE**  
AR 261/58  
0 - 80 mm  
0 - 3 inch



**TOWNLEY**  
AR 262/12  
0-80 mm



AR 263/11  
0-100 mm



AR 263/12  
0-80 mm



AR 263/13  
0-80 mm





**BOLEY**  
AR 264/11  
0-100 mm



**BOLEY**  
AR 264/12  
0-100 mm



**VERNIER**  
AR 265/20  
0-200 mm



**MOELTGEN**  
AR 268/00

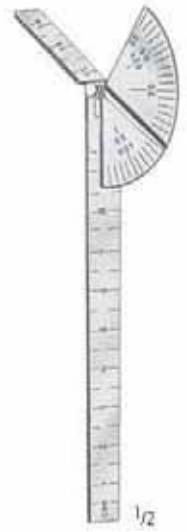

**CAROLL**  
AR 270/00

AA  
AB  
AC  
AD  
AE  
AF  
AK  
AL  
AM  
AO  
AP  
AR  
KA  
KD  
KU  
KY

Messinstrumente  
 Measuring Instruments  
 Instrumentos para medidas  
 Instruments pour mesurer  
 Strumenti per misurare

**COLLIN**

AR 274/00

Erwachsene  
 Adults  
 Adultos  
 Adultes  
 Adulti

AR 275/00

Kinder  
 Children  
 Niños  
 Enfants  
 Bambini



**DYNAMOMETER III**

AR 278/00

DIAGNOSTIK DIAGNOSTICS DIAGNOSTICO DIAGNOSTIC DIAGNOSTICA

Messinstrumente  
Measuring Instruments  
Instrumentos para medidas  
Instruments pour mesurer  
Strumenti per misurare



**IWANSON**  
AR 281/00  
12,0 cm/4<sup>3</sup>/<sub>4</sub>"

für Kronen  
for crowns



**IWANSON**  
AR 282/00  
12,0 cm/4<sup>3</sup>/<sub>4</sub>"

mit Tropfenspitzen für Wachs  
with drop tips for wax



**CASTROVIEJO**  
AR 282/15  
8,0 cm/ 3"

Messbereich 15 mm  
measuring range 15 mm  
campo de medición 15 mm  
étendue de mesurage 15 mm  
ampiezza di misura 15 mm



**CASTROVIEJO**  
AR 282/20  
8,0 cm/ 3"

Messbereich 20 mm  
measuring range 20 mm  
campo de medición 20 mm  
étendue de mesurage 20 mm  
ampiezza di misura 20 mm



**CASTROVIEJO**  
AR 283/20  
8,0 cm/ 3"

Messbereich 20 mm  
measuring range 20 mm  
campo de medición 20 mm  
étendue de mesurage 20 mm  
ampiezza di misura 20 mm



**CASTROVIEJO-EPKER**  
AR 284/09  
9,0 cm/ 3<sup>1</sup>/<sub>2</sub>"  
0-40 mm



**CASTROVIEJO-EPKER**  
AR 284/18  
18,0 cm/ 7"  
0-40 mm

AA  
AB  
AC  
AD  
AE  
AF  
AK  
AL  
AM  
AO  
AP  
AR  
KA  
KD  
KU  
KY

Sensibilitats-Instrumente  
 Sensibility Instruments  
 Instrumentos sensibilidad  
 Instruments sensibilités  
 Strumenti per sensibilità



AR 297/16  
 16,0 cm/6<sup>1</sup>/<sub>4</sub>"

AR 298/16  
 16,0 cm/6<sup>1</sup>/<sub>4</sub>"



**ALY**  
 AR 300/00  
 19,0 cm/7<sup>1</sup>/<sub>2</sub>"



**WARTENBERG**  
 AR 301/00



AR 302/00

Stethoskope  
Stethoscopes  
Estetoscopios  
Stéthoscopes  
Stetoscopi



aus Holz  
of wood  
de madera  
en bois  
In legno

1/2

**PINARD**  
AR 310/01



aus Aluminium  
of aluminium  
de aluminio  
en aluminium  
In alluminio

1/2

**PINARD**  
AR 310/02



aus Plastik  
of plastic  
de plàstica  
en plastique  
In plastica

1/2

**PINARD**  
AR 310/03

AA  
AB  
AC  
AD  
AE  
AF  
AK  
AL  
AM  
AO  
AP  
AR  
KA  
KD  
KY

Stethoskope  
Stethoscopes  
Estetoscopios  
Stéthoscopes  
Stetoscopi



**CARDIOPHON**  
AR 321/00



**DUPLEX-LIGHTWEIGHT/BABY**  
AR 322/00 100 g



Blutdruckmesser  
 Blood Pressure Manometers  
 Manómetro para la presión de la sangre  
 Tensiómètre à mercure  
 Sfigmomanometro a mercurio

mit Velcromanschette  
 with velcro cuff  
 con brazaletto velcro  
 avec manchette velcro  
 con bracciale velcro

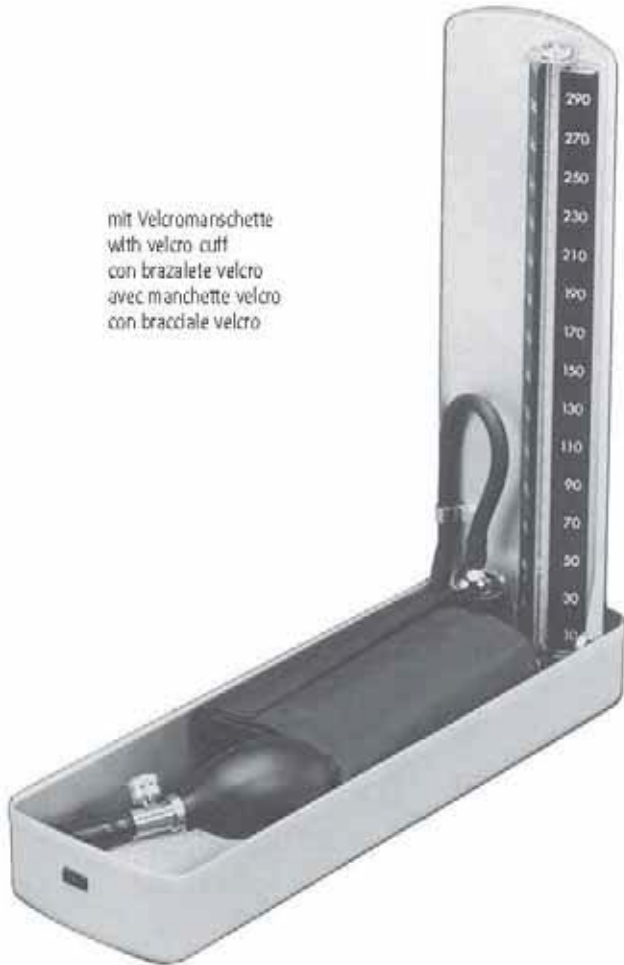

**DIPLOMAT**  
 AR 350/00



**PRECISA**  
 AR 352/00

AA  
 AB  
 AC  
 AD  
 AE  
 AF  
 AK  
 AL  
 AM  
 AO  
 AP  
 AR  
 KA  
 KD  
 KU  
 KY

Diagnostik-Bestecke  
 Diagnostic Sets  
 Juegos para diagnóstico  
 Trousses à diagnostic  
 Astucci per diagnostica



**ECONOM**  
 AR 400/00



**RISCOPE S OTO - / OPHTHALMOSKOP**  
 AR 402/00

Diagnostik-Bestecke  
 Diagnostic Sets  
 Juegos para diagnóstico  
 Trousses à diagnostic  
 Astucci per diagnostica



**OTOSKOP UNI**  
 AR 410/00



**RISCOPE S OPHTHALMOSKOP**  
 AR 420/00

AA  
 AB  
 AC  
 AD  
 AE  
 AF  
 AK  
 AL  
 AM  
 AO  
 AP  
 AR  
 KA  
 KD  
 KU  
 KY



ORTHOPÄDIE  
ORTHOPAEDIC  
ORTOPEDIA  
ORTHOPEDIE  
ORTOPEDIA

KA

nopa<sup>®</sup> instruments



Amputations- und Resektionssägen  
 Amputating and Resection Saws  
 Sierras para amputación y resección  
 Scies à amputation et résection  
 Seghe per amputazione e resezione

Ersatzsägeblatt  
 Spare saw blade  
 Hoja de sierra de repuesto  
 Lame de scie de rechange  
 Lama di sega di ricambio

12 mm KA 011/12  
 15 mm KA 011/15



**CHARRIERE**  
 KA 010/35  
 35,0 cm/14"

Ersatzsägeblatt  
 Spare saw blade  
 Hoja de sierra de repuesto  
 Lame de scie de rechange  
 Lama di sega di ricambio

3 mm KA 013/03  
 5 mm KA 013/05  
 7 mm KA 013/07



**HELFERICH-BIER**  
 KA 012/39  
 39,0 cm/15 1/2"



**LINDEMANN**  
 KA 017/20  
 20,0 cm/8"



**LANGENBECK**  
 KA 018/23  
 23,0 cm/9"



**CHARRIERE**  
 27,0 cm/10 1/2" KA 020/27  
 30,0 cm/12" KA 020/30  
 34,0 cm/13 1/2" KA 020/34



**SATTERLEE**  
 KA 025/31  
 31,0 cm/12 1/4"



Handbohrapparate  
Hand Drills  
Perforadores de mano  
Perforateurs à main  
Perforatori a mano



**STILLE-SHERMAN**

KA 050/24  
24,0 cm/9 1/2"

komplett  
complete  
completo  
complet  
completo



KA 051/25  
Ø 2,5 mm



KA 051/30  
Ø 3,0 mm



KA 051/35  
Ø 3,5 mm

AA  
AB  
AC  
AD  
AE  
AF  
AK  
AL  
AM  
AO  
AP  
AR  
KA  
KD  
KU  
KY

KA

Handbohrapparate  
 Hand Drills  
 Perforadores de mano  
 Perforateurs à main  
 Perforatori a mano



**STILLE**  
 KA 060/00  
 20,0 cm/8"

komplett mit  
 complete with  
 completo con  
 complet avec  
 completo con

Fig. 1-9  
 Fig. 1-9  
 Fig. 1-9  
 Fig. 1-9  
 Fig. 1-9



Fig. 1  
 KA 060/01  
 Ø 2,5 mm



Fig. 2  
 KA 060/02  
 Ø 3,0 mm



Fig. 3  
 KA 060/03  
 Ø 3,5 mm



Fig. 4  
 KA 060/04  
 Ø 4,0 mm



Fig. 5  
 KA 060/05  
 Ø 10,0 mm



Fig. 6  
 KA 060/06  
 Ø 5,0 mm



Fig. 7  
 KA 060/07  
 Ø 8,0 mm



Fig. 8  
 KA 060/08  
 Ø 12,0 mm



Fig. 9  
 KA 060/09  
 Ø 16,0 mm



Fig. 10  
 KA 060/10  
 Ø 1,0 mm



Fig. 11  
 KA 060/11  
 Ø 1,5 mm



Fig. 12  
 KA 060/12  
 Ø 2,0 mm

Handbohrapparate  
Hand Drills  
Perforadores de mano  
Perforateurs à main  
Perforatori a mano



**HUDSON**  
KA 070/00  
27,0 cm/10 1/2"

komplett mit  
complete with  
completo con  
complet avec  
completo con

KA 070/01-04, 09  
KA 070/01-04, 09  
KA 070/01-04, 09  
KA 070/01-04, 09  
KA 070/01-04, 09



1/2

KA 070/01  
Ø 9,0 mm



1/2

KA 070/02  
Ø 14,0 mm



1/2

KA 070/03  
Ø 16,0 mm



1/2

KA 070/04  
Ø 22,0 mm



1/2

**CUSHING**  
KA 070/05  
Ø 14,0 mm



1/2

KA 070/09



1/2

Ø 3,2 mm  
9,0 cm



1/2

Ø 3,2 mm  
7,0 cm



**MOORE**  
KA 080/04

komplett mit  
complete with  
completo con  
complet avec  
completo con

1 x 9,0 cm + 2 x 7,0 cm  
1 x 9,0 cm + 2 x 7,0 cm  
1 x 9,0 cm + 2 x 7,0 cm  
1 x 9,0 cm + 2 x 7,0 cm  
1 x 9,0 cm + 2 x 7,0 cm

1/2

AA  
AB  
AC  
AD  
AE  
AF  
AK  
AL  
AM  
AO  
AP  
AR  
KA  
KD  
KU  
KY

Handbohrapparate  
 Hand Drills  
 Perforadores de mano  
 Perforateurs à main  
 Perforatori a mano



Handbohrapparate  
Hand Drills  
Perforadores de mano  
Perforateurs à main  
Perforatori a mano



**UNIVERSAL 11"**  
KA 098/00



**RALK**  
KA 100/00

Ø 1,0 mm	KA 102/10
Ø 1,5 mm	KA 102/15
Ø 2,0 mm	KA 102/20
Ø 2,7 mm	KA 102/27
Ø 3,0 mm	KA 102/30
Ø 3,2 mm	KA 102/32
Ø 3,5 mm	KA 102/35
Ø 4,0 mm	KA 102/40
Ø 4,5 mm	KA 102/45
Ø 5,0 mm	KA 102/50
Ø 6,0 mm	KA 102/60
Ø 7,0 mm	KA 102/70
Ø 8,0 mm	KA 102/80
Ø 9,0 mm	KA 102/90
Ø 10,0 mm	KA 102/99

Handbohrapparate  
Hand Drills  
Perforadores de mano  
Perforateurs à main  
Perforatori a mano



KA 103/00



KA 103/10



KA 104/00  
16,0 cm/6<sup>1</sup>/<sub>4</sub>"



**PERTHES**  
KA 104/01  
21,0 cm/8<sup>1</sup>/<sub>4</sub>"



KA 104/02  
14,0 cm/5<sup>1</sup>/<sub>2</sub>"



**ADISON**  
KA 104/03  
15,0 cm/6"





KA 120/00  
Akku Bohraparat / Akku power drill

Spannung / Voltage	9,6 Volt
Drehzahl / Revolutions	0-750 U/min
Leistung / Power	130/200 Watt



KA 121/00  
Luft Bohraparat / Air power drill

Drehzahl / Revolutions	600 U/min
Druck / Compression	6,5 bar

AA  
AB  
AC  
AD  
AE  
AF  
AK  
AL  
AM  
AO  
AP  
AR  
**KA**  
KD  
KU  
KY

Zubehör für KA 120/00 und KA 121/00  
 Accessories for KA 120/00 and KA 121/00  
 Accesorios para KA 120/00 y KA 121/00  
 Accessoires pour KA 120/00 et KA 121/00  
 Accessori per KA 120/00 e KA 121/00



KA 122/10  
 Adapter mit Jacobs Spannfutter  
 Adapter with Jacobs chuck



KA 122/16  
 Schnellspannfutter für Kirschnerdrähte 0,8 bis 3mm  
 Quick-action chuck for Kirschner wires 0,8 to 3mm



KA 122/11  
 Adapter für AO Schaft  
 Adapter for AO shank



KA 123/01  
 Osteotomie Säge oszillierend  
 Sagittal saw oscillating



KA 122/13  
 Adapter für DIN Schaft  
 Adapter for DIN shank



KA 123/02  
 Sternum Säge  
 Sternum Saw



KA 122/14  
 Adapter für Harris Schaft  
 Adapter for Harris shank



KA 122/15  
 Adapter für Hudson Schaft  
 Adapter for Hudson shank

Ladegerät / Akku  
 Charger / Battery  
 Cargador / acumulador  
 Chargeur d'accus / accumulateur  
 Caricabatteria / accumulatore



KA 124/01  
 Ladegerät Netzspannung 115V / 240V Ladezeit 60 min  
 Charger main voltage 115V / 240V charging time 60 min



KA 124/02  
 Ladegerät für 2 Akkus Netzspannung 115V / 240V  
 Ladezeit 60 min  
 Charger for 2 batteries main voltage 115V / 240V  
 Charging time 60 min



KA 124/10  
 9,6V 2600mAh



KA 124/11  
 12V 2600mAh

AA  
 AB  
 AC  
 AD  
 AE  
 AF  
 AK  
 AL  
 AM  
 AO  
 AP  
 AR  
**KA**  
 KD  
 KU  
 KY

Knochenhalteklammern  
 Bone Holding Clamps  
 Clamp sujetador de huesos  
 Daviers à os  
 Tenaglie per ossa



**GERSTER-LOWMANN**

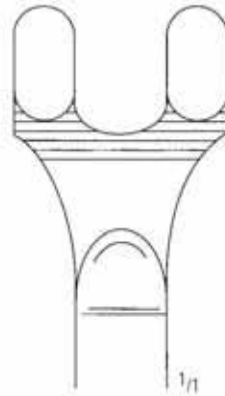

KA 155/18  
 18,0 cm/7"

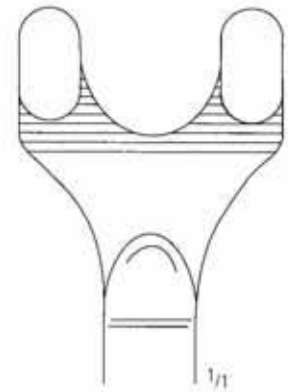

KA 155/20  
 20,0 cm/8"

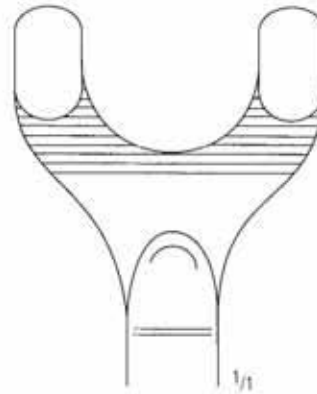

KA 155/22  
 22,0 cm/8<sup>3</sup>/<sub>4</sub>"



**GERSTER**  
 KA 155/90

Knochenhebel  
 Bone Levers  
 Elevadores para huesos  
 Leviers à os  
 Elevatori per ossa

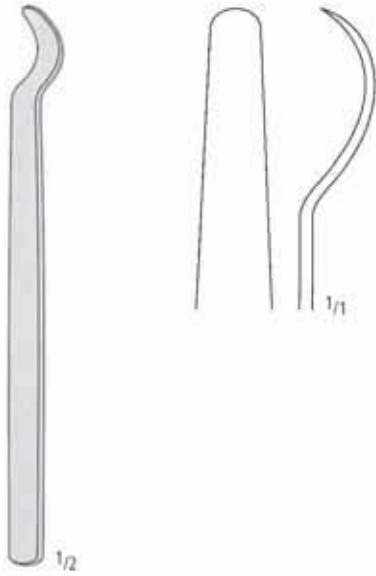

KA 170/00  
 14,0 cm/5<sup>1</sup>/<sub>2</sub>"

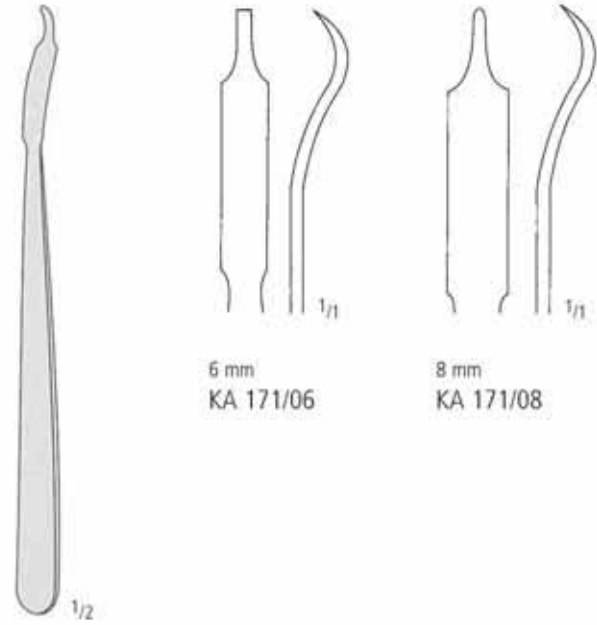

6 mm  
 KA 171/06

8 mm  
 KA 171/08

**MINI-HOHMANN**  
 16,0 cm/6<sup>1</sup>/<sub>4</sub>"

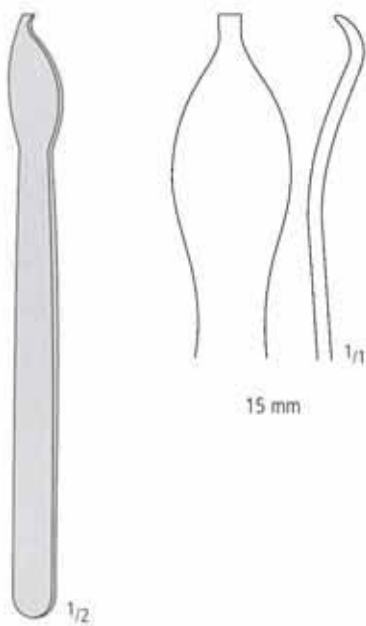

KA 171/15  
 17,0 cm/6<sup>3</sup>/<sub>4</sub>"

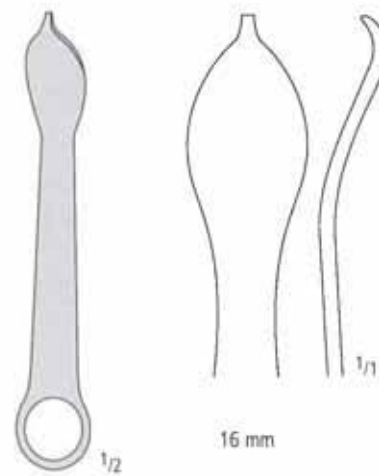

KA 171/16  
 12,0 cm/4<sup>3</sup>/<sub>4</sub>"

AA  
 AB  
 AC  
 AD  
 AE  
 AF  
 AK  
 AL  
 AM  
 AO  
 AP  
 AR  
 KA  
 KD  
 KU  
 KY

Knochenhebel  
 Bone Levers  
 Elevadores para huesos  
 Leviers à os  
 Elevatori per ossa



**HOHMANN**  
 KA 172/08  
 22,0 cm/8<sup>3</sup>/<sub>4</sub>"

**HOHMANN**  
 KA 172/18  
 24,0 cm/9<sup>1</sup>/<sub>2</sub>"

**HOHMANN**  
 KA 172/43  
 26,0 cm/10<sup>1</sup>/<sub>4</sub>"

**HOHMANN**  
 KA 172/70  
 29,0 cm/11<sup>1</sup>/<sub>2</sub>"



Knochenhebel  
 Bone Levers  
 Elevadores para huesos  
 Leviers à os  
 Elevatori per ossa



**HOHMANN**  
 KA 173/22  
 25,0 cm/9<sup>3</sup>/<sub>4</sub>"

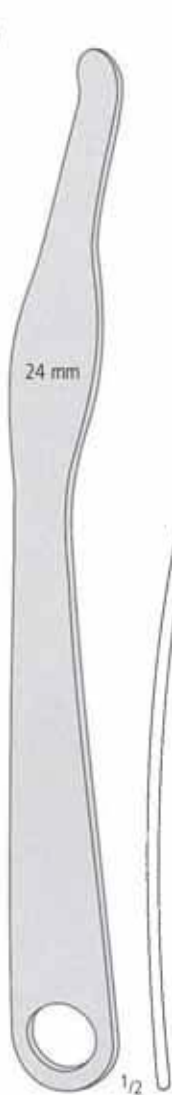

**HOHMANN**  
 KA 173/24  
 28,0 cm/11"

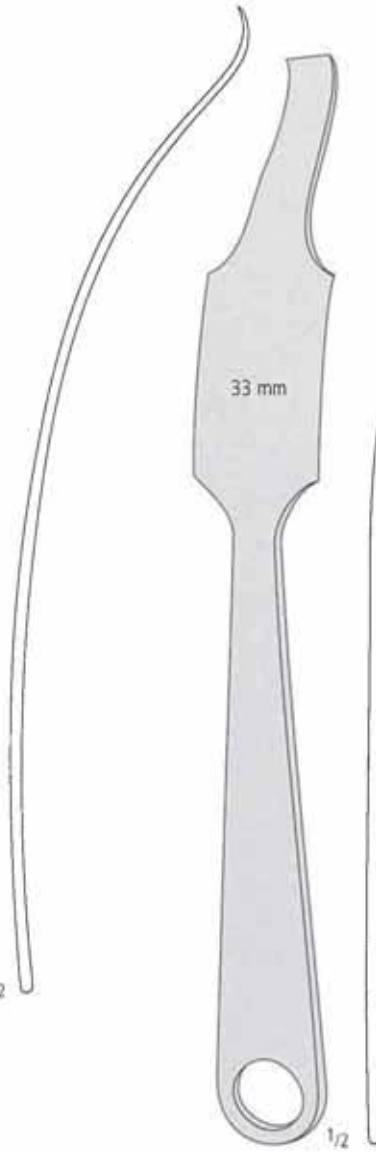

**HOHMANN**  
 KA 173/35  
 29,0 cm/11<sup>1</sup>/<sub>2</sub>"



**HOHMANN**  
 KA 173/43  
 25,0 cm/9<sup>3</sup>/<sub>4</sub>"

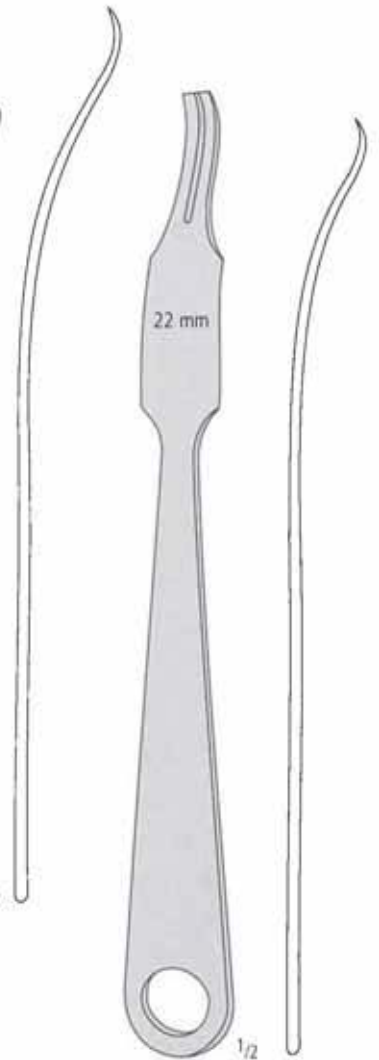

**LANGE-HOHMANN**  
 KA 174/22  
 26,0 cm/10<sup>1</sup>/<sub>4</sub>"

AA  
 AB  
 AC  
 AD  
 AE  
 AF  
 AG  
 AH  
 AI  
 AJ  
 AK  
 AL  
 AM  
 AN  
 AO  
 AP  
 AQ  
 AR  
 AS  
 AT  
 AU  
 AV  
 AW  
 AX  
 AY  
 AZ

KA

KD

KU

KY

Knochenhebel  
 Bone Levers  
 Elevadores para huesos  
 Leviers à os  
 Elevatori per ossa



**BLOUNT**  
 KA 175/26  
 26,0 cm/10<sup>1</sup>/<sub>4</sub>"



**BLOUNT**  
 KA 176/26  
 26,0 cm/10<sup>1</sup>/<sub>4</sub>"



**TAYLOR**  
 16,5 cm/6<sup>1</sup>/<sub>2</sub>"

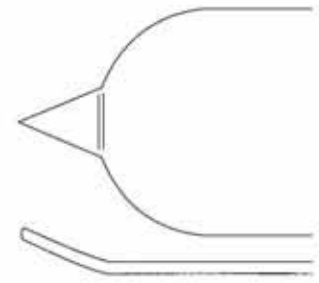

**KA 177/01**  
 75 x 30 mm

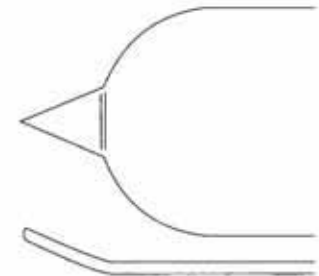

**KA 177/02**  
 100 x 30 mm



**BLOUNT**  
 KA 177/17  
 17,5 cm/7"



**CREGO**  
 KA 178/01  
 19,0 cm/7<sup>1</sup>/<sub>2</sub>"



**CREGO**  
 KA 178/02  
 19,0 cm/7<sup>1</sup>/<sub>2</sub>"



**CREGO**  
 KA 178/03  
 19,0 cm/7<sup>1</sup>/<sub>2</sub>"



**CREGO**  
 KA 178/04  
 19,0 cm/7<sup>1</sup>/<sub>2</sub>"

ORTHOPÄDIE ORTHOPAEDIC ORTOPEDIA ORTHOPEDIE ORTOPEDIA

Extensionsbügel  
 Extension Bows  
 Estribos para extensión  
 Etriers à extension  
 Archi per estensione

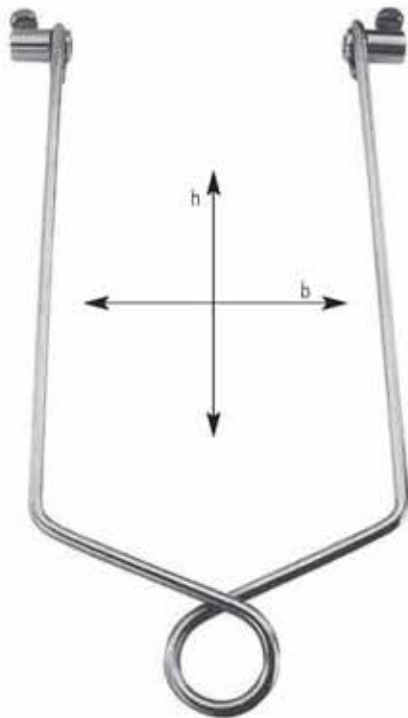

**BÖHLER**

cm h x b	in. h x b	
16 x 9	6 <sup>1</sup> / <sub>4</sub> x 3 <sup>1</sup> / <sub>2</sub>	KA 200/01
21 x 11	8 <sup>1</sup> / <sub>4</sub> x 4 <sup>1</sup> / <sub>3</sub>	KA 200/02
21 x 15	8 <sup>1</sup> / <sub>4</sub> x 6	KA 200/03

für Arm  
 for arm  
 para brazo  
 pour bras  
 per braccio

für Oberschenkel und Knie  
 for thigh and knee  
 para muslo y rodilla  
 pour fémur et genou  
 per femore e ginocchio

für Oberschenkel und Knie  
 for thigh and knee  
 para muslo y rodilla  
 pour fémur et genou  
 per femore e ginocchio



**STEINMANN**

Ø	L	
4 mm	130 mm	KA 201/13
4 mm	140 mm	KA 201/14
4 mm	150 mm	KA 201/15
4 mm	160 mm	KA 201/16
4 mm	180 mm	KA 201/18
4 mm	200 mm	KA 201/20
4 mm	210 mm	KA 201/21

AA  
AB  
AC  
AD  
AE  
AF  
AK  
AL  
AM  
AO  
AP  
AR  
KA  
KD  
KU  
KY

KA

Extensionsbügel  
 Extension Bows  
 Etribos para extensión  
 Etriers à extension  
 Archi per estensione

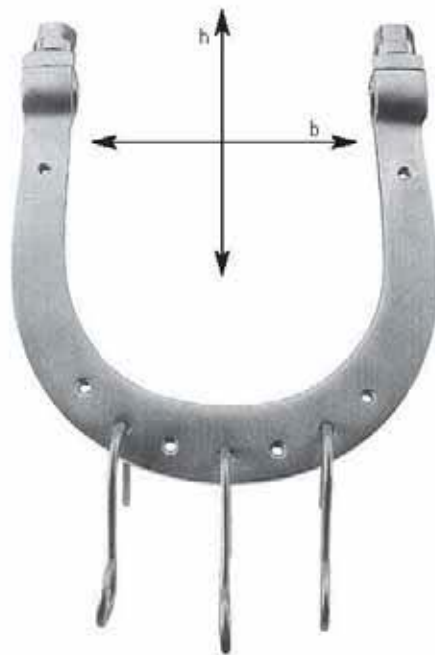

**KIRSCHNER**

cm h x b	in. h x b	
6,0 x 6,0	2 <sup>1</sup> / <sub>2</sub> x 2 <sup>1</sup> / <sub>2</sub>	KA 220/00
7,0 x 9,5	2 <sup>3</sup> / <sub>4</sub> x 3 <sup>3</sup> / <sub>4</sub>	KA 220/01
10,5 x 10,5	4 <sup>1</sup> / <sub>4</sub> x 4 <sup>1</sup> / <sub>4</sub>	KA 220/02
12,0 x 12,0	4 <sup>3</sup> / <sub>4</sub> x 4 <sup>3</sup> / <sub>4</sub>	KA 220/03
15,5 x 15,5	6 x 6	KA 220/04
15,5 x 20,0	6 x 8	KA 220/05

KA 220/90

Drahtzangen  
Wire Forceps  
Pinzas para hilos  
Pincas à fil  
Tenaglie fili



**NIRO**  
KA 250/00  
15,0 cm/6"



KA 250/14  
14,0 cm/5 1/2"



KA 251/14  
14,0 cm/5 1/2"



KA 252/16  
16,0 cm/6 1/4"



KA 253/19  
19,0 cm/7 1/2"

AA  
AB  
AC  
AD  
AE  
AF  
AK  
AL  
AM  
AO  
AP  
AR  
**KA**  
KD  
KU  
KY

Drahtzangen  
Wire Forceps  
Pinzas para hilos  
Pincas à fil  
Tenaglie fili



KA 255/01

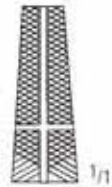

KA 255/02

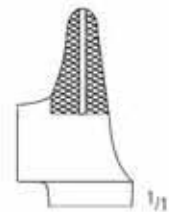

KA 257/15  
15,0 cm/6"

17,0 cm/6<sup>3</sup>/<sub>4</sub>"



18,0 cm/7"



KA 260/18



KA 261/18



KA 262/18



KA 263/18



ORTHOPÄDIE ORTHOPAEDIC ORTOPEDIA ORTHOPEDIE ORTOPEDIA

Drahtzangen  
Wire Forceps  
Pinzas para hilos  
Pincers à fil  
Tenaglie fili



AE 550/13  
13,0 cm/5"



AE 550/18  
18,0 cm/7"



AE 551/01  
15,0 cm/6"



AE 551/02  
18,0 cm/7"



AE 552/18  
18,5 cm/7 1/4"

STERNUM

nopa  
**TUC<sup>®</sup>**



18,0 cm/7"



AE 554/01  
5,0 mm



AE 554/02  
3,0 mm



AE 554/03  
7,0 mm



AE 556/01  
16,5 cm/6 1/2"



AE 556/02  
15,0 cm/6"

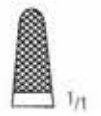

AE 556/03  
15,0 cm/6"

CORWIN

AA  
AB  
AC  
AD  
AE  
AF  
AK  
AL  
AM  
AO  
AP  
AR  
KA  
KD  
KU  
KY

Flachzangen  
 Flat Nose Pliers  
 Alicates planos  
 Pinces plates  
 Tenaglie piatte



KA 265/18  
 18,0 cm/7"



KA 266/17  
 17,0 cm/6<sup>3</sup>/<sub>4</sub>"

Drahtzangen  
Wire Forceps  
Pinzas para hilos  
Pinces à fil  
Tenaglie fili



für weiche Drähte bis 1,2 mm Ø  
for soft wires up to 1,2 mm Ø  
para hilos blandos hasta 1,2 mm de Ø  
pour fils mous jusqu'à 1,2 mm de Ø  
per fili morbidi sino a mm 1,2 di Ø

für harte Drähte bis 1,0 mm Ø  
for hard wires up to 1,0 mm Ø  
para hilos duros hasta 1,0 mm de Ø  
pour fils durs jusqu'à 1,0 mm de Ø  
per fili duri sino a mm 1,0 di Ø

KA 270/15  
15,0 cm/6"



KA 271/16  
16 cm/6<sup>1</sup>/<sub>4</sub>"

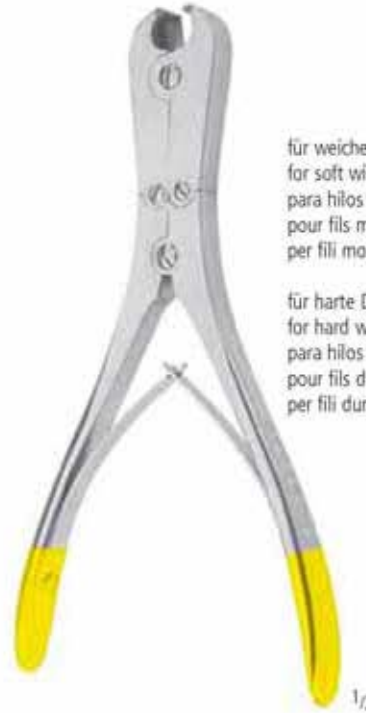

für weiche Drähte bis 2,0 mm Ø  
for soft wires up to 2,0 mm Ø  
para hilos blandos hasta 2,0 mm de Ø  
pour fils mous jusqu'à 2,0 mm de Ø  
per fili morbidi sino a mm 2,0 di Ø

für harte Drähte bis 1,5 mm Ø  
for hard wires up to 1,5 mm Ø  
para hilos duros hasta 1,5 mm de Ø  
pour fils durs jusqu'à 1,5 mm de Ø  
per fili duri sino a mm 1,5 di Ø

KA 272/18  
18,0 cm/7"

nopa  
**TUC<sup>®</sup>**



für weiche Drähte bis 2,0 mm Ø  
for soft wires up to 2,0 mm Ø  
para hilos blandos hasta 2,0 mm de Ø  
pour fils mous jusqu'à 2,0 mm de Ø  
per fili morbidi sino a mm 2,0 di Ø

für harte Drähte bis 1,6 mm Ø  
for hard wires up to 1,6 mm Ø  
para hilos duros hasta 1,6 mm de Ø  
pour fils durs jusqu'à 1,6 mm de Ø  
per fili duri sino a mm 1,6 di Ø

KA 273/17  
17,0 cm/6<sup>3</sup>/<sub>4</sub>"

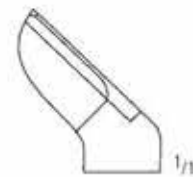

für Drähte bis 2,5 mm Ø  
for wires up to 2,5 mm Ø  
para hilos hasta 2,5 mm de Ø  
pour fils jusqu'à 2,5 mm de Ø  
per fili sino a mm 2,5 di Ø

KA 273/22  
22 cm/8<sup>3</sup>/<sub>4</sub>"

AA  
AB  
AC  
AD  
AE  
AF  
AK  
AL  
AM  
AO  
AP  
AR  
KA  
KD  
KU  
KY

Drahtzangen  
Wire Forceps  
Pinzas para hilos  
Pinces à fil  
Tenaglie fili



KA 275/47  
47,0 cm/18 1/2"

Drahtspanninstrumente  
 Wire Twisting Instruments  
 Tensores cierra-hilos  
 Tendeurs s erre-fils  
 Strumenti tendifili



**LOUTE**  
 KA 280/21  
 21,0 cm/8<sup>1</sup>/<sub>4</sub>"



**DEMEL**

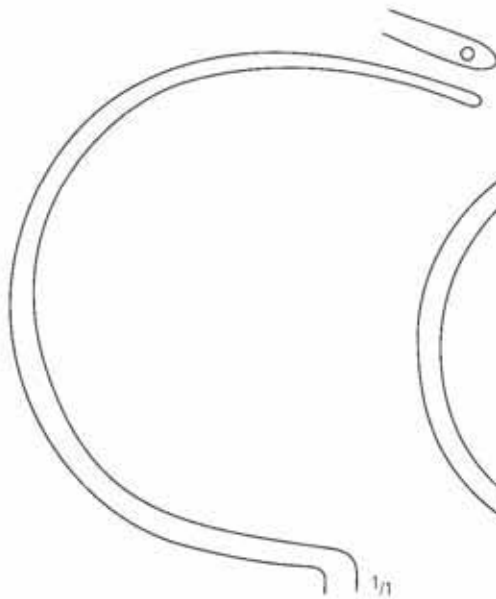

KA 281/01  
 30,5 cm/12"



KA 281/02  
 28,5 cm/11<sup>1</sup>/<sub>4</sub>"



KA 281/03  
 27,5 cm/10<sup>3</sup>/<sub>4</sub>"

AA  
 AB  
 AC  
 AD  
 AE  
 AF  
 AK  
 AL  
 AM  
 AO  
 AP  
 AR  
**KA**  
 KD  
 KU  
 KY

Arthroskopie  
Arthroscopy  
Artroscopia  
Arthroscopie  
Artroscopia



1/1  
Ø 4 mm  
KA 300/01  
22,5 cm/9"

5 mm



KA 300/02



KA 300/03



KA 300/04



KA 300/05

4 mm



KA 300/06

3 mm



KA 300/07

1/1



KA 300/08



KA 300/09

Ø 3 mm



KA 300/10

Ø 3 mm



KA 300/11



KA 300/12

3,5 mm



KA 300/13

1/1



ORTHOPÄDIE ORTHOPAEDIC ORTOPEDIA ORTHOPEDIE ORTOPEDIA

Arthroskopie  
Arthroscopy  
Artroscopia  
Arthroscopie  
Artroscopia

Griff allein  
Handle only  
Mango solo  
Manche seul  
Solo impugnatura



KA 302/00  
12,5 cm/5"



KA 302/01



KA 302/02



KA 302/03



KA 302/04



KA 302/05



KA 302/06



KA 302/07



KA 302/08



KA 302/09



KA 302/10



KA 302/11



KA 302/12



KA 302/13



KA 302/14



KA 302/15



KA 302/16



KA 302/17



KA 302/18



KA 302/19

AA  
AB  
AC  
AD  
AE  
AF  
AG  
AH  
AI  
AJ  
AK  
AL  
AM  
AN  
AO  
AP  
AQ  
AR  
AS  
AT  
AU  
AV  
AW  
AX  
AY  
AZ  
BA  
BB  
BC  
BD  
BE  
BF  
BG  
BH  
BI  
BJ  
BK  
BL  
BM  
BN  
BO  
BP  
BQ  
BR  
BS  
BT  
BU  
BV  
BW  
BX  
BY  
CA  
CB  
CC  
CD  
CE  
CF  
CG  
CH  
CI  
CJ  
CK  
CL  
CM  
CN  
CO  
CP  
CQ  
CR  
CS  
CT  
CU  
CV  
CW  
CX  
CY

Ø 3 mm

Ø 3 mm

Ø 7 mm

3 mm

5 mm

7 mm

2,5 mm

3,5 mm

KA

KD

KU

KY

Arthroscopie  
Arthroscopy  
Artroscopio  
Arthroscopie  
Artroscopia

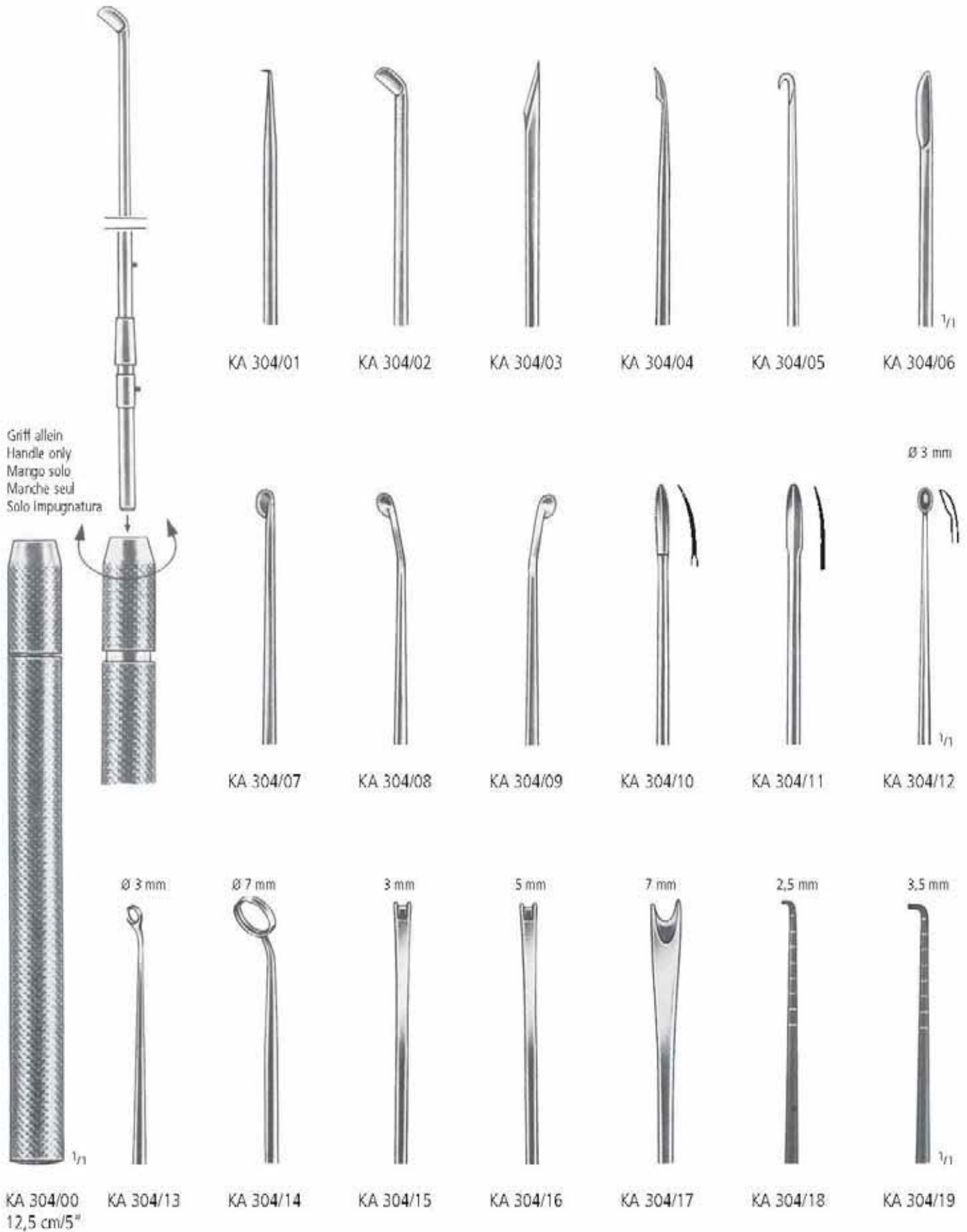

KA 304/00  
12,5 cm/5"

KA 304/13

KA 304/14

KA 304/15

KA 304/16

KA 304/17

KA 304/18

KA 304/19

Arthroskopie  
Arthroscopy  
Artroscopio  
Arthroscopie  
Artroscopia

- >> Bitte beachten Sie folgende Symbole für Arthroskopiezangen.
- >> Kindly note the following symbols for Arthroscopy Forceps.
- >> Tengan en cuenta los siguientes símbolos para pinzas de artroscopio.
- >> Veuillez noter les différentes spécifications pour les pinces arthroscopie.
- >> Notate le seguenti indicazioni per le pinze per artroscopia.

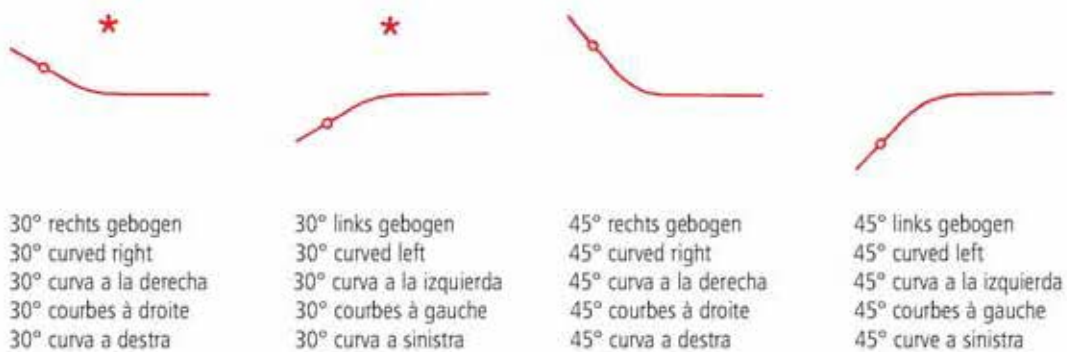

- \* >> Standardbiegung beträgt 30°. Auf Anfrage sind auch andere Biegungen lieferbar.
- \* >> Standard angle is 30°. Other angles are available on request.
- \* >> Angulo standard del extremo 30°. Otros ángulos se pueden fabricar sobre pedido.
- \* >> L'angle standard est de 30°. D'autres angles sont disponibles sur demande.
- \* >> L'angolo standard è di 30°. Altre angolazioni sono disponibili su richiesta.

AA

AB

AC

AD

AE

AF

AK

AL

AM

AO

AP

AR

KA

KD

KU

KY

**KA** ORTHOPÄDIE ORTHOPAEDIC ORTOPEDIA ORTHOPEDIE ORTOPEDIA

Arthroskopie  
Arthroscopy  
Artroscopio  
Arthroscopie  
Artroscopia



2/1

Ø 2,7 mm  
Ø 3,4 mm  
Ø 4,5 mm

KA 320/10  
KA 321/10  
KA 322/10

KA 320/11  
KA 321/11  
KA 322/11

KA 320/13  
KA 321/13  
KA 322/13

KA 320/15  
KA 321/15  
KA 322/15

KA 320/17  
KA 321/17  
KA 322/17

KA 320/19  
KA 321/19  
KA 322/19

KA 320/21  
KA 321/21  
KA 322/21



2/1

Ø 2,7 mm  
Ø 3,4 mm  
Ø 4,5 mm

KA 323/10  
KA 324/10  
KA 325/10

KA 323/11  
KA 324/11  
KA 325/11

KA 323/13  
KA 324/13  
KA 325/13

KA 323/15  
KA 324/15  
KA 325/15

KA 323/17  
KA 324/17  
KA 325/17

KA 323/19  
KA 324/19  
KA 325/19

KA 323/21  
KA 324/21  
KA 325/21



2/1

Ø 3,4 mm

KA 326/10

KA 326/11

KA 326/13

KA 326/15

KA 326/17

KA 326/19

KA 326/21



2/1

Ø 3,4 mm

KA 327/10

KA 327/11

KA 327/13

KA 327/15

KA 327/17

KA 327/19

KA 327/21

Arthroskopie  
Arthroscopy  
Artroscopio  
Arthroscopie  
Artroscopia



Mit Überlastungsschutz  
With overload protection  
Con protección para exceso de carga  
Avec protection de surcharge  
Con protezione incorporata



2/1

Ø 2,7 mm  
Ø 3,4 mm  
Ø 4,5 mm

KA 328/10  
KA 329/10  
KA 330/10

KA 328/11  
KA 329/11  
KA 330/11

KA 328/13  
KA 329/13  
KA 330/13

KA 328/15  
KA 329/15  
KA 330/15

KA 328/17  
KA 329/17  
KA 330/17

KA 328/19  
KA 329/19  
KA 330/19

KA 328/21  
KA 329/21  
KA 330/21



2/1

Ø 2,7 mm  
Ø 3,4 mm  
Ø 4,5 mm

KA 331/10  
KA 332/10  
KA 333/10

KA 331/11  
KA 332/11  
KA 333/11

KA 331/13  
KA 332/13  
KA 333/13

KA 331/15  
KA 332/15  
KA 333/15

KA 331/17  
KA 332/17  
KA 333/17

KA 331/19  
KA 332/19  
KA 333/19

KA 331/21  
KA 332/21  
KA 333/21



2/1

Ø 3,4 mm

KA 334/10

KA 334/11

KA 334/13

KA 334/15

KA 334/17

KA 334/19

KA 334/21



2/1

Ø 3,4 mm

KA 335/10

KA 335/11

KA 335/13

KA 335/15

KA 335/17

KA 335/19

KA 335/21

AA  
AB  
AC  
AD  
AE  
AF  
AK  
AL  
AM  
AO  
AP  
AR  
KA  
KD  
KU  
KY

KA



**KA** ORTHOPÄDIE ORTHOPAEDIC ORTOPEDIA ORTHOPEDIE ORTOPEDIA

Arthroskopie  
Arthroscopy  
Artroscopio  
Arthroscopie  
Artroscopia



2/1

Ø 3,4 mm



Mit Überlastungsschutz  
With overload protection  
Con protección para exceso de carga  
Avec protection de surcharge  
Con protezione incorporata



2/1

Ø 3,4 mm

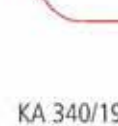



Arthroscopie  
Arthroscopy  
Artroscopia  
Arthroscopie  
Artroscopia



2/1

Ø 2,0 mm



KA 345/10



2/1

Ø 2,0 mm



KA 345/20



2/1

Ø 2,0 mm



KA 345/30



2/1

Ø 2,0 mm



KA 345/40

AA

AB

AC

AD

AE

AF

AK

AL

AM

AO

AP

AR

**KA**

KD

KU

KY

Maßtabelle  
 Scale  
 Tabla de medida  
 Tableau de la mesure  
 Scala



2,0 mm



3,0 mm



4,0 mm



5,0 mm



6,0 mm



8,0 mm



10,0 mm



12,0 mm



14,0 mm



16,0 mm



18,0 mm



20,0 mm



25,0 mm



30,0 mm

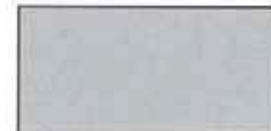

35,0 mm



40,0 mm



45,0 mm



50,0 mm

Meißel und Osteotome  
Chisels, Gouges and Osteotomes  
Cinceles y Gubias  
Ciseaux-Burins et Ostéotomes  
Scalpelli, Osteotomi, Sgorbie



1/2

mm 13,5 cm/5 1/4"

- 8 KA 400/08
- 10 KA 400/10
- 12 KA 400/12
- 14 KA 400/14
- 16 KA 400/16



1/2

13,5 cm/5 1/4"

- KA 401/08
- KA 401/10
- KA 401/12
- KA 401/14
- KA 401/16



1/2

13,5 cm/5 1/4"

- KA 402/08
- KA 402/10
- KA 402/12
- KA 402/14
- KA 402/16



1/2

**HOKE**  
mm 14,0 cm/5 1/2"

- 3 KA 404/03
- 5 KA 404/05
- 6 KA 404/06
- 8 KA 404/08
- 9 KA 404/09



1/2

**LUCAS**  
mm 16,0 cm/6 1/8"

- 4 KA 406/04
- 6 KA 406/06



1/2

**LUCAS**  
mm 16,0 cm/6 1/8"

- 3 KA 407/03
- 5 KA 407/05

AA  
AB  
AC  
AD  
AE  
AF  
AK  
AL  
AM  
AO  
AP  
AR  
**KA**  
KD  
KU  
KY

Meißel und Osteotome  
 Chisels, Gouges and Osteotomes  
 Cinceles y Gubias  
 Ciseaux-Burins et Ostéotomes  
 Scalpelli, Osteotomi, Sgorbie



	<b>ALEXANDER</b>
	18,0 cm/7"
mm	
4	KA 418/04
6	KA 418/06
8	KA 418/08
10	KA 418/10
12	KA 418/12
14	KA 418/14

	<b>ALEXANDER</b>
	18,0 cm/7"
mm	
4	KA 419/04
6	KA 419/06
8	KA 419/08
10	KA 419/10
12	KA 419/12
14	KA 419/14



13,5 cm/5 1/4"	17,0 cm/6 3/4"
KA 433/02	KA 437/02
KA 433/03	KA 437/03
KA 433/04	KA 437/04
KA 433/05	KA 437/05
KA 433/06	KA 437/06
KA 433/07	KA 437/07
KA 433/08	KA 437/08

**PARTSCH**

mm	13,5 cm/5 1/4"	17,0 cm/6 3/4"
2	KA 443/02	KA 447/02
3	KA 443/03	KA 447/03
4	KA 443/04	KA 447/04
5	KA 443/05	KA 447/05
6	KA 443/06	KA 447/06
7	KA 443/07	KA 447/07
8	KA 443/08	KA 447/08

Meißel und Osteotome  
 Chisels, Gouges and Osteotomes  
 Cinceles y Gubias  
 Ciseaux-Burins et Ostéotomes  
 Scalpelli, Osteotomi, Sgorbie



**SMITH-PETERSEN**  
 20,0 cm/8"

mm	KA 450/06	KA 451/06	KA 452/09	KA 453/09
6	KA 450/06	KA 451/06		KA 453/09
9	KA 450/09	KA 451/09	KA 452/09	
13	KA 450/13	KA 451/13		KA 453/14
14			KA 452/14	
16	KA 450/16	KA 451/16		KA 453/19
19	KA 450/19	KA 451/19	KA 452/19	KA 453/25
25	KA 450/25	KA 451/25	KA 452/25	
32	KA 450/32	KA 451/32		

AA  
AB  
AC  
AD  
AE  
AF  
AK  
AL  
AM  
AO  
AP  
AR  
KA  
KD  
KY

Meißel und Osteotome  
 Chisels, Gouges and Osteotomes  
 Cinceles y Gubias  
 Ciseaux-Burins et Ostéotomes  
 Scalpelli, Osteotomi, Sgorbie



**HIBBS**  
 24,0 cm/9<sup>1</sup>/<sub>2</sub>"

mm	KA 455/06	KA 456/06	KA 457/06	KA 458/06	KA 459/06
6	KA 455/13	KA 456/13	KA 457/13	KA 458/13	KA 459/13
13	KA 455/19	KA 456/19	KA 457/19	KA 458/19	KA 459/19
19	KA 455/25	KA 456/25	KA 457/25	KA 458/25	KA 459/25
25	KA 455/32	KA 456/32	KA 457/32	KA 458/32	KA 459/32
32					



Meißel und Osteotome  
 Chisels, Gouges and Osteotomes  
 Cinceles y Gubias  
 Ciseaux-Burins et Ostéotomes  
 Scalpelli, Osteotomi, Sgorbie



**STILLE**  
 20,0 cm/8"

mm				
4		KA 461/04		
6		KA 461/06		
8	KA 460/08	KA 461/08	KA 462/08	KA 463/08
10	KA 460/10	KA 461/10	KA 462/10	KA 463/10
15	KA 460/15	KA 461/15	KA 462/15	KA 463/15
20	KA 460/20	KA 461/20	KA 462/20	KA 463/20
25	KA 460/25	KA 461/25	KA 462/25	KA 463/25

AA  
AB  
AC  
AD  
AE  
AF  
AK  
AL  
AM  
AO  
AP  
AR  
KA  
KD  
KY

Meißel und Osteotome  
 Chisels, Gouges and Osteotomes  
 Cinceles y Gubias  
 Ciseaux-Burins et Ostéotomes  
 Scalpelli, Osteotomi, Sgorbie



**MINI-LEXER**  
 18,0 cm/7"



**MINI-LEXER**  
 18,0 cm/7"



**LEXER**  
 22,0 cm/8<sup>3</sup>/<sub>4</sub>"



**LEXER**  
 22,0 cm/8<sup>3</sup>/<sub>4</sub>"

mm  
 4  
 6  
 7  
 8  
 10  
 12  
 15  
 20  
 25  
 30

KA 470/04  
 KA 470/06  
 KA 470/08  
 KA 470/10  
 KA 470/12  
 KA 470/15  
 KA 470/20

KA 471/04  
 KA 471/06  
 KA 471/08  
 KA 471/10  
 KA 471/12  
 KA 471/15  
 KA 471/20

KA 472/07  
 KA 472/10  
 KA 472/15  
 KA 472/20  
 KA 472/25  
 KA 472/30

KA 473/07  
 KA 473/10  
 KA 473/15  
 KA 473/20  
 KA 473/25  
 KA 473/30

Ferrozellgriff  
 Hartpress-Handle  
 Mango en "Ferrozell"  
 Manche en "Ferrozell"  
 Manico in "Ferrozell"

Meißel und Osteotome  
Chisels, Gouges and Osteotomes  
Cinceles y Gubias  
Ciseaux-Burins et Ostéotomes  
Scalpelli, Osteotomi, Sgorbie



**LEXER**  
27,5 cm/10<sup>3</sup>/<sub>4</sub>"

mm  
5  
10 KA 474/10  
15 KA 474/15



**LEXER**  
27,5 cm/10<sup>3</sup>/<sub>4</sub>"

KA 475/10  
KA 475/15



**LEXER**  
25,0 cm/10"

KA 476/05  
KA 476/10  
KA 476/15



**LEXER**  
25,0 cm/10"

KA 477/05  
KA 477/10  
KA 477/15

Ferrozellgriff  
Hartpress-Handle  
Mango en "Ferrozell"  
Manche en "Ferrozell"  
Manico in "Ferrozell"

AA  
AB  
AC  
AD  
AE  
AF  
AK  
AL  
AM  
AO  
AP  
AR  
KA  
KD  
KU  
KY

Meißel und Osteotome  
 Chisels, Gouges and Osteotomes  
 Cinceles y Gubias  
 Ciseaux-Burins et Ostéotomes  
 Scalpelli, Osteotomi, Sgorbie



**COBB**  
 28,0 cm/11"

KA 478/01



**COBB**  
 28,0 cm/11"

KA 478/02



**COBB**  
 28,0 cm/11"

KA 478/03



**COBB**  
 28,0 cm/11"

KA 478/04

ORTHOPÄDIE ORTHOPAEDIC ORTOPEDIA ORTHOPEDIE ORTOPEDIA

Meißel und Osteotome  
 Chisels, Gouges and Osteotomes  
 Cinceles y Gubias  
 Ciseaux-Burins et Ostéotomes  
 Scalpelli, Osteotomi, Sgorbie

AA  
AB  
AC  
AD  
AE  
AF  
AK  
AL  
AM  
AO  
AP  
AR  
KA  
KD  
KU  
KY

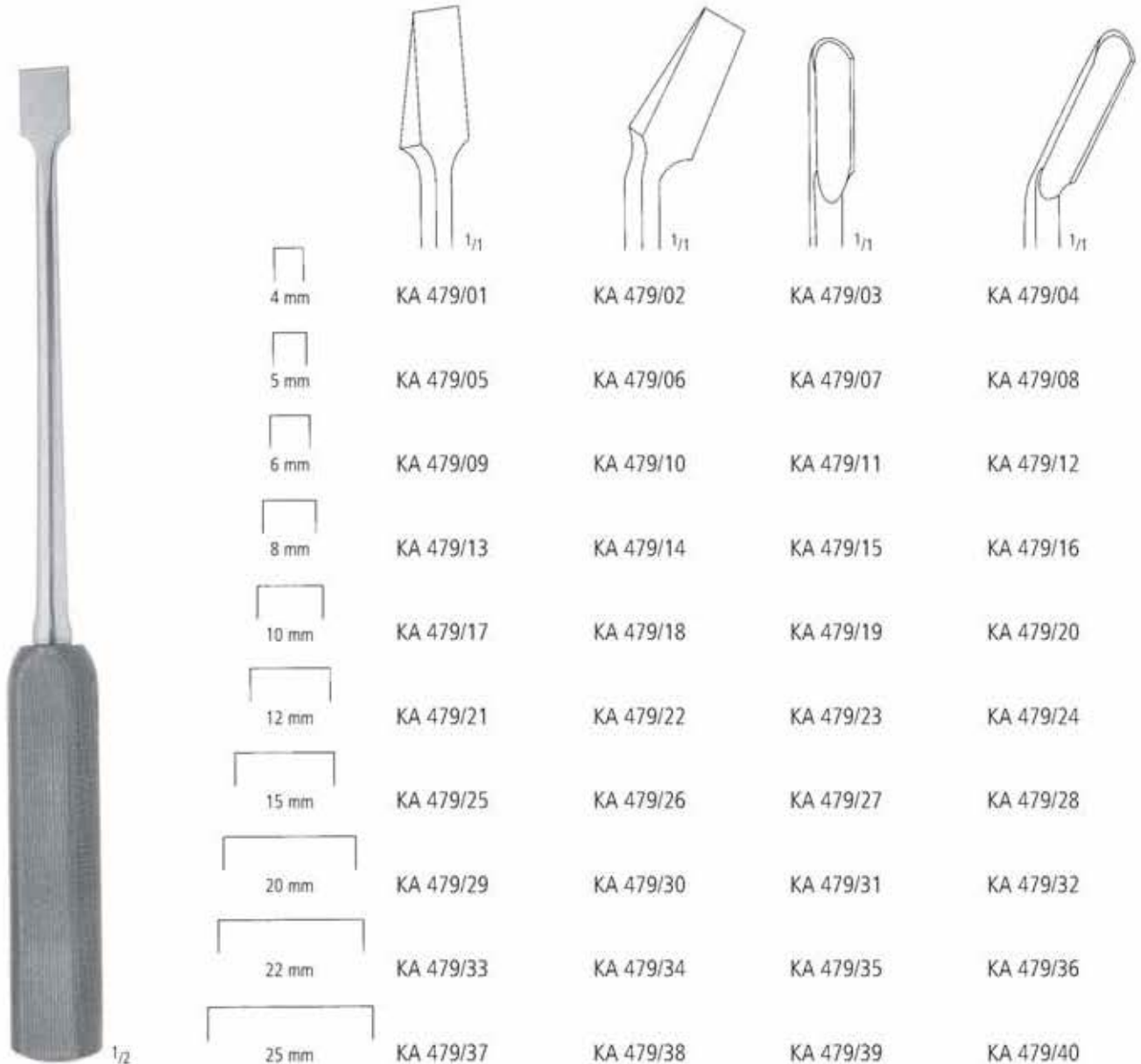

**DAHMEN**  
 30,0 cm/12"

Ferrozellgriff  
 Hartpress-Handle  
 Mango en "Ferrozell"  
 Manche en "Ferrozell"  
 Manico in "Ferrozell"

Meißel und Osteotome  
 Chisels, Gouges and Osteotomes  
 Cinceles y Gubias  
 Ciseaux-Burins et Ostéotomes  
 Scalpelli, Osteotomi, Sgorbie



**MINI-LAMBOTTE**  
 12,5 cm/5"

**MINI-LAMBOTTE**  
 17,0 cm/6<sup>3</sup>/<sub>4</sub>"

**LAMBOTTE**  
 24,0 cm/9<sup>1</sup>/<sub>2</sub>"

**LAMBOTTE**  
 23,0 cm/9"

mm	
3	KA 480/03
4	KA 480/04
6	KA 480/06
8	KA 480/08
10	KA 480/10
12	KA 480/12
15	KA 480/15

KA 481/03
KA 481/04
KA 481/06
KA 481/08
KA 481/10
KA 481/12
KA 481/15

mm	
15	KA 482/15
20	KA 482/20
25	KA 482/25
30	KA 482/30
38	KA 482/38
44	KA 482/44
50	KA 482/50

KA 483/15
KA 483/20
KA 483/25
KA 483/30
KA 483/38
KA 483/44
KA 483/50



Hämmer  
Mallets  
Martillos  
Marteaux  
Martelli

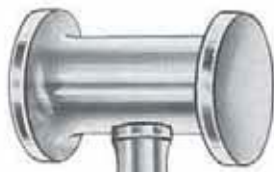

300 g  
(10<sup>3</sup>/<sub>4</sub> oz.)



1/2

**BERGMANN**  
KA 517/30  
24,0 cm/9<sup>1</sup>/<sub>2</sub>"



300 g  
(10<sup>3</sup>/<sub>4</sub> oz.)



1/2

**BERGMANN**  
KA 518/30  
23,0 cm/9"



550 g  
(19<sup>1</sup>/<sub>2</sub> oz.)



1/2

**OMBREDANNE**  
KA 519/55  
24,0 cm/9<sup>1</sup>/<sub>2</sub>"

AA

AB

AC

AD

AE

AF

AK

AL

AM

AO

AP

AR

**KA**

KD

KU

KY

Hämmer  
Mallets  
Martillos  
Marteaux  
Martelli



KA 520/30  
Ø 26 mm  
300 g (10<sup>3</sup>/<sub>4</sub> oz.)

KA 520/34  
Ø 28 mm  
340 g (12 oz.)

KA 520/40  
Ø 30 mm  
400 g (14<sup>1</sup>/<sub>4</sub> oz.)

1/2

**WILLIGER**  
24,0 cm/9<sup>1</sup>/<sub>2</sub>"



KA 530/12  
Ø 25 mm  
120 g (4<sup>1</sup>/<sub>4</sub> oz.)

KA 530/18  
Ø 30 mm  
180 g (6<sup>1</sup>/<sub>2</sub> oz.)

KA 530/26  
Ø 35 mm  
260 g (9<sup>1</sup>/<sub>4</sub> oz.)

1/2

**DOYEN**  
20,0 cm/8<sup>1</sup>/<sub>4</sub>"



1/2

**COTTLE**  
KA 531/24  
19,0 cm/7<sup>1</sup>/<sub>2</sub>"  
240 g (8<sup>1</sup>/<sub>2</sub> oz.)

Hämmer  
Mallets  
Martillos  
Marteaux  
Martelli



Ø 30 mm  
220 g  
(7¾ oz.)

1/2

**COLLIN**  
KA 532/22  
20,0 cm/8"



Ø 27 mm  
140 g  
(5 oz.)

1/2

**HAJEK**  
KA 533/14  
22,0 cm/8¾"



KA 534/02 (Paar/pair)

Ø 25 mm  
140 g  
(5 oz.)

1/2

KA 534/14  
18,0 cm/7"

AA

AB

AC

AD

AE

AF

AK

AL

AM

AO

AP

AR

**KA**

KD

KU

KY

Hämmer  
Mallets  
Martillos  
Marteaux  
Martelli



KA 535/16

KA 536/16

bleigefüllt  
lead filled  
relleno de plomo  
garni de plomb  
guarnito di piombo

Messing, massiv  
brass, solid  
latón, macizo  
laiton, solide  
ottone, solido

Hämmer  
Mallets  
Martillos  
Marteaux  
Martelli



450 g  
(16 oz.)

KA 546/45  
26,5 cm/10½"



900 g  
(32 oz.)

KA 546/90  
26,5 cm/10½"



Ø 42 mm

Ø 30 mm  
530 g  
(19 oz.)

KA 550/53  
24,0 cm/9½"

AA

AB

AC

AD

AE

AF

AK

AL

AM

AO

AP

AR

KA

KD

KU

KY

Hämmer  
Mallets  
Martillos  
Marteaux  
Martelli



Ø 80 x 60 mm  
400 g  
(14 1/4 oz.)

**STEINBACH**  
KA 551/40  
24,0 cm/9 1/2"



Ø 45 mm  
290 g  
(10 1/2 oz.)

KA 552/29  
23,0 cm/9"



KA 553/35  
Ø 35 mm  
KA 553/42  
Ø 42 mm  
KA 553/50  
Ø 50 mm

25,0 cm/10"



Hämmer  
Mallets  
Martillos  
Marteaux  
Martelli



KA 554/90



KA 554/37  
370 g (12<sup>3</sup>/<sub>4</sub> oz.)  
Ferrozell



KA 555/13  
125 g (4<sup>1</sup>/<sub>4</sub> oz.)  
Ferrozell

AA

AB

AC

AD

AE

AF

AK

AL

AM

AO

AP

AR

**KA**

KD

KU

KY

Scharfe Löffel  
 Bone Curettes  
 Cucharillas cortantes  
 Curettes tranchantes  
 Curette taglienti



**VOLKMANN**  
 17,0 cm/6<sup>3</sup>/<sub>4</sub>"



Fig. 0000  
 KA 600/00



Fig. 000  
 KA 601/00



Fig. 00  
 KA 602/00



Fig. 0  
 KA 603/00



Fig. 1  
 KA 603/01



Fig. 2  
 KA 603/02



Fig. 3  
 KA 603/03



Fig. 4  
 KA 603/04



Fig. 5  
 KA 603/05



Fig. 6  
 KA 603/06



**BRUNS**  
 17,0 cm/6<sup>3</sup>/<sub>4</sub>"



Fig. 000  
 KA 610/00



Fig. 00  
 KA 611/00



Fig. 0  
 KA 612/00



Fig. 1  
 KA 612/01



Fig. 2  
 KA 612/02



Fig. 3  
 KA 612/03



Fig. 4  
 KA 612/04



Fig. 5  
 KA 612/05



Fig. 6  
 KA 612/06

Scharfe Löffel  
 Bone Curettes  
 Cucharillas cortantes  
 Curettes tranchantes  
 Curette taglienti

AA  
 AB  
 AC  
 AD  
 AE  
 AF  
 AK  
 AL  
 AM  
 AO  
 AP  
 AR  
 KA  
 KD  
 KU  
 KY



Fig. 000  
 KA 615/00



Fig. 00  
 KA 616/00



Fig. 0  
 KA 617/00



Fig. 1  
 KA 617/01



Fig. 2  
 KA 617/02



Fig. 3  
 KA 617/03



Fig. 4  
 KA 617/04



Fig. 5  
 KA 617/05



**SPRATT**  
 17,0 cm/6<sup>3</sup>/<sub>4</sub>"



**SCHEDE**  
 17,0 cm/6<sup>3</sup>/<sub>4</sub>"



Fig. 000  
 KA 620/00



Fig. 00  
 KA 621/00



Fig. 0  
 KA 622/00



Fig. 1  
 KA 622/01



Fig. 2  
 KA 622/02



Fig. 3  
 KA 622/03



Fig. 4  
 KA 622/04

Scharfe Löffel  
 Bone Currettes  
 Cucharillas cortantes  
 Curettes tranchantes  
 Curette taglienti



2 mm  
 KA 623/02



3 mm  
 KA 623/03



4 mm  
 KA 623/04



5 mm  
 KA 623/05



6 mm  
 KA 623/06



3 mm  
 KA 623/13



4 mm  
 KA 623/14



5 mm  
 KA 623/15



6 mm  
 KA 623/16



**FOX**



**PIFFARD**



4 mm  
 KA 624/01



5 mm  
 KA 624/02



6 mm  
 KA 624/03

Scharfe Löffel  
 Bone Curettes  
 Cucharillas cortantes  
 Curettes tranchantes  
 Curette taglienti

AA  
 AB  
 AC  
 AD  
 AE  
 AF  
 AK  
 AL  
 AM  
 AO  
 AP  
 AR  
 KA  
 KD  
 KU  
 KY



**BRUNS**  
 23,0 cm/9"

Fig. 000  
 KA 625/00

Fig. 00  
 KA 625/01

Fig. 0  
 KA 625/02

Fig. 1  
 KA 625/03

Fig. 2  
 KA 625/04

Fig. 3  
 KA 625/05

Fig. 4  
 KA 625/06

Fig. 5  
 KA 625/07

Fig. 6  
 KA 625/08



**CLOWARD  
 HIBBS SPRATT  
 SPINAL FUSION**  
 22,5 cm/9"

Fig. 000  
 KA 626/00

Fig. 00  
 KA 627/00

Fig. 0  
 KA 628/00

Fig. 1  
 KA 628/01

Fig. 2  
 KA 628/02

Fig. 3  
 KA 628/03

Fig. 4  
 KA 628/04

Fig. 5  
 KA 628/05

Fig. 6  
 KA 628/06



**CLOWARD  
 HIBBS SPRATT  
 SPINAL FUSION**  
 22,5 cm/9"

Fig. 000  
 KA 629/00

Fig. 00  
 KA 630/00

Fig. 0  
 KA 631/00

Fig. 1  
 KA 631/01

Fig. 2  
 KA 631/02

Fig. 3  
 KA 631/03

Fig. 4  
 KA 631/04

Fig. 5  
 KA 631/05

Fig. 6  
 KA 631/06

Scharfe Löffel  
 Bone Currettes  
 Cucharillas cortantes  
 Curettes tranchantes  
 Curette taglienti



25,0 cm/9<sup>3</sup>/<sub>4</sub>"

3,6 mm  
 KA 632/00

4,4 mm  
 KA 632/01

5,2 mm  
 KA 632/02

6,0 mm <sup>1</sup>/<sub>1</sub>  
 KA 632/03



25,0 cm/9<sup>3</sup>/<sub>4</sub>"

3,6 mm  
 KA 633/00

4,4 mm  
 KA 633/01

5,2 mm  
 KA 633/02

6,0 mm <sup>1</sup>/<sub>1</sub>  
 KA 633/03



ORTHOPÄDIE ORTHOPAEDIC ORTOPEDIA ORTHOPEDIE ORTOPEDIA

Scharfe Löffel  
 Bone Currettes  
 Cucharillas cortantes  
 Curettes tranchantes  
 Curette taglienti



**HATFIELD**  
 23,0 cm/9"

  
 3,00 x 5,00 mm  
 KA 634/00

  
 3,50 x 5,50 mm  
 KA 634/01

  
 4,50 x 6,40 mm  
 KA 634/02

  
 5,00 x 8,00 mm  
 KA 634/03

  
 6,00 x 9,00 mm  
 KA 634/04

  
 7,00 x 11,00 mm  
 KA 634/05

  
 8,50 x 12,50 mm  
 KA 634/06

  
 9,50 x 14,50 mm  
 KA 634/07

  
 10,50 x 16,80 mm  
 KA 634/08



**HATFIELD**  
 28,0 cm/11"

  
 3,00 x 5,00 mm  
 KA 635/00

  
 3,50 x 5,50 mm  
 KA 635/01

  
 4,50 x 6,40 mm  
 KA 635/02

  
 5,00 x 8,00 mm  
 KA 635/03

  
 6,00 x 9,00 mm  
 KA 635/04

  
 7,00 x 11,00 mm  
 KA 635/05

  
 8,50 x 12,50 mm  
 KA 635/06

  
 9,50 x 14,50 mm  
 KA 635/07

  
 10,50 x 16,80 mm  
 KA 635/08



**COBB**  
 28,0 cm/11"

  
 4,06 x 5,08 mm  
 KA 636/00

  
 5,08 x 6,35 mm  
 KA 636/01

  
 6,10 x 7,62 mm  
 KA 636/02

  
 7,11 x 8,89 mm  
 KA 636/03

  
 8,13 x 10,16 mm  
 KA 636/04

  
 9,14 x 11,43 mm  
 KA 636/05

  
 10,16 x 12,70 mm  
 KA 636/06

  
 11,18 x 13,97 mm  
 KA 636/07

  
 12,19 x 15,24 mm  
 KA 636/08

AA  
 AB  
 AC  
 AD  
 AE  
 AF  
 AG  
 AH  
 AI  
 AJ  
 AK  
 AL  
 AM  
 AN  
 AO  
 AP  
 AQ  
 AR  
 AS  
 AT  
 AU  
 AV  
 AW  
 AX  
 AY  
 AZ  
 BA  
 BB  
 BC  
 BD  
 BE  
 BF  
 BG  
 BH  
 BI  
 BJ  
 BK  
 BL  
 BM  
 BN  
 BO  
 BP  
 BQ  
 BR  
 BS  
 BT  
 BU  
 BV  
 BW  
 BX  
 BY  
 BZ  
 CA  
 CB  
 CC  
 CD  
 CE  
 CF  
 CG  
 CH  
 CI  
 CJ  
 CK  
 CL  
 CM  
 CN  
 CO  
 CP  
 CQ  
 CR  
 CS  
 CT  
 CU  
 CV  
 CW  
 CX  
 CY  
 CZ  
 DA  
 DB  
 DC  
 DD  
 DE  
 DF  
 DG  
 DH  
 DI  
 DJ  
 DK  
 DL  
 DM  
 DN  
 DO  
 DP  
 DQ  
 DR  
 DS  
 DT  
 DU  
 DV  
 DW  
 DX  
 DY  
 DZ  
 EA  
 EB  
 EC  
 ED  
 EE  
 EF  
 EG  
 EH  
 EI  
 EJ  
 EK  
 EL  
 EM  
 EN  
 EO  
 EP  
 EQ  
 ER  
 ES  
 ET  
 EU  
 EV  
 EW  
 EX  
 EY  
 EZ  
 FA  
 FB  
 FC  
 FD  
 FE  
 FF  
 FG  
 FH  
 FI  
 FJ  
 FK  
 FL  
 FM  
 FN  
 FO  
 FP  
 FQ  
 FR  
 FS  
 FT  
 FU  
 FV  
 FW  
 FX  
 FY  
 FZ  
 GA  
 GB  
 GC  
 GD  
 GE  
 GF  
 GG  
 GH  
 GI  
 GJ  
 GK  
 GL  
 GM  
 GN  
 GO  
 GP  
 GQ  
 GR  
 GS  
 GT  
 GU  
 GV  
 GW  
 GX  
 GY  
 GZ  
 HA  
 HB  
 HC  
 HD  
 HE  
 HF  
 HG  
 HH  
 HI  
 HJ  
 HK  
 HL  
 HM  
 HN  
 HO  
 HP  
 HQ  
 HR  
 HS  
 HT  
 HU  
 HV  
 HW  
 HX  
 HY  
 HZ  
 IA  
 IB  
 IC  
 ID  
 IE  
 IF  
 IG  
 IH  
 II  
 IJ  
 IK  
 IL  
 IM  
 IN  
 IO  
 IP  
 IQ  
 IR  
 IS  
 IT  
 IU  
 IV  
 IW  
 IX  
 IY  
 IZ  
 JA  
 JB  
 JC  
 JD  
 JE  
 JF  
 JG  
 JH  
 JI  
 JJ  
 JK  
 JL  
 JM  
 JN  
 JO  
 JP  
 JQ  
 JR  
 JS  
 JT  
 JU  
 JV  
 JW  
 JX  
 JY  
 JZ  
 KA  
 KB  
 KC  
 KD  
 KE  
 KF  
 KG  
 KH  
 KI  
 KJ  
 KK  
 KL  
 KM  
 KN  
 KO  
 KP  
 KQ  
 KR  
 KS  
 KT  
 KU  
 KV  
 KW  
 KX  
 KY  
 KZ  
 LA  
 LB  
 LC  
 LD  
 LE  
 LF  
 LG  
 LH  
 LI  
 LJ  
 LK  
 LL  
 LM  
 LN  
 LO  
 LP  
 LQ  
 LR  
 LS  
 LT  
 LU  
 LV  
 LW  
 LX  
 LY  
 LZ  
 MA  
 MB  
 MC  
 MD  
 ME  
 MF  
 MG  
 MH  
 MI  
 MJ  
 MK  
 ML  
 MM  
 MN  
 MO  
 MP  
 MQ  
 MR  
 MS  
 MT  
 MU  
 MV  
 MW  
 MX  
 MY  
 MZ  
 NA  
 NB  
 NC  
 ND  
 NE  
 NF  
 NG  
 NH  
 NI  
 NJ  
 NK  
 NL  
 NM  
 NN  
 NO  
 NP  
 NQ  
 NR  
 NS  
 NT  
 NU  
 NV  
 NW  
 NX  
 NY  
 NZ  
 OA  
 OB  
 OC  
 OD  
 OE  
 OF  
 OG  
 OH  
 OI  
 OJ  
 OK  
 OL  
 OM  
 ON  
 OO  
 OP  
 OQ  
 OR  
 OS  
 OT  
 OU  
 OV  
 OW  
 OX  
 OY  
 OZ  
 PA  
 PB  
 PC  
 PD  
 PE  
 PF  
 PG  
 PH  
 PI  
 PJ  
 PK  
 PL  
 PM  
 PN  
 PO  
 PP  
 PQ  
 PR  
 PS  
 PT  
 PU  
 PV  
 PW  
 PX  
 PY  
 PZ  
 QA  
 QB  
 QC  
 QD  
 QE  
 QF  
 QG  
 QH  
 QI  
 QJ  
 QK  
 QL  
 QM  
 QN  
 QO  
 QP  
 QQ  
 QR  
 QS  
 QT  
 QU  
 QV  
 QW  
 QX  
 QY  
 QZ  
 RA  
 RB  
 RC  
 RD  
 RE  
 RF  
 RG  
 RH  
 RI  
 RJ  
 RK  
 RL  
 RM  
 RN  
 RO  
 RP  
 RQ  
 RR  
 RS  
 RT  
 RU  
 RV  
 RW  
 RX  
 RY  
 RZ  
 SA  
 SB  
 SC  
 SD  
 SE  
 SF  
 SG  
 SH  
 SI  
 SJ  
 SK  
 SL  
 SM  
 SN  
 SO  
 SP  
 SQ  
 SR  
 SS  
 ST  
 SU  
 SV  
 SW  
 SX  
 SY  
 SZ  
 TA  
 TB  
 TC  
 TD  
 TE  
 TF  
 TG  
 TH  
 TI  
 TJ  
 TK  
 TL  
 TM  
 TN  
 TO  
 TP  
 TQ  
 TR  
 TS  
 TU  
 TV  
 TW  
 TX  
 TY  
 TZ  
 UA  
 UB  
 UC  
 UD  
 UE  
 UF  
 UG  
 UH  
 UI  
 UJ  
 UK  
 UL  
 UM  
 UN  
 UO  
 UP  
 UQ  
 UR  
 US  
 UT  
 UY  
 UZ  
 VA  
 VB  
 VC  
 VD  
 VE  
 VF  
 VG  
 VH  
 VI  
 VJ  
 VK  
 VL  
 VM  
 VN  
 VO  
 VP  
 VQ  
 VR  
 VS  
 VT  
 VU  
 VV  
 VW  
 VX  
 VY  
 VZ  
 WA  
 WB  
 WC  
 WD  
 WE  
 WF  
 WG  
 WH  
 WI  
 WJ  
 WK  
 WL  
 WM  
 WN  
 WO  
 WP  
 WQ  
 WR  
 WS  
 WT  
 WU  
 WV  
 WW  
 WX  
 WY  
 WZ  
 XA  
 XB  
 XC  
 XD  
 XE  
 XF  
 XG  
 XH  
 XI  
 XJ  
 XK  
 XL  
 XM  
 XN  
 XO  
 XP  
 XQ  
 XR  
 XS  
 XT  
 XU  
 XV  
 XW  
 XX  
 XY  
 XZ  
 YA  
 YB  
 YC  
 YD  
 YE  
 YF  
 YG  
 YH  
 YI  
 YJ  
 YK  
 YL  
 YM  
 YN  
 YO  
 YP  
 YQ  
 YR  
 YS  
 YT  
 YU  
 YV  
 YW  
 YX  
 YY  
 YZ  
 ZA  
 ZB  
 ZC  
 ZD  
 ZE  
 ZF  
 ZG  
 ZH  
 ZI  
 ZJ  
 ZK  
 ZL  
 ZM  
 ZN  
 ZO  
 ZP  
 ZQ  
 ZR  
 ZS  
 ZT  
 ZU  
 ZV  
 ZW  
 ZX  
 ZY  
 ZZ

Scharfe Löffel  
 Bone Curettes  
 Cucharillas cortantes  
 Curettes tranchantes  
 Curette taglienti

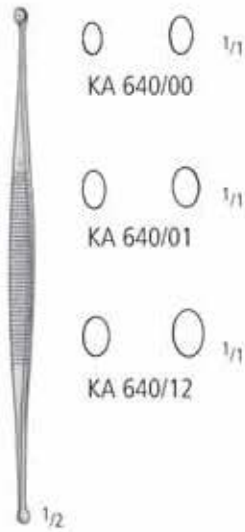

**WILLIGER**  
 13,5 cm/5<sup>1</sup>/<sub>4</sub>"

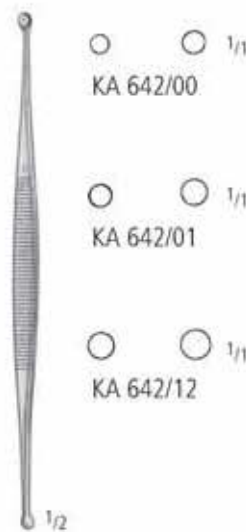

**MARTINI**  
 13,5 cm/5<sup>1</sup>/<sub>4</sub>"



**JANSEN**  
 KA 644/16  
 16,0 cm/6<sup>1</sup>/<sub>4</sub>"



**JANSEN**  
 KA 645/15  
 15,0 cm/6"



**KA 648/21**  
 21,0 cm/8<sup>1</sup>/<sub>4</sub>"



**VOLKMANN** KA 650/13  
 13,0 cm/5"

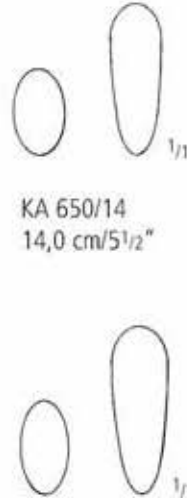

**KA 650/14**  
 14,0 cm/5<sup>1</sup>/<sub>2</sub>"



**KA 650/17**  
 17,0 cm/6<sup>3</sup>/<sub>4</sub>"

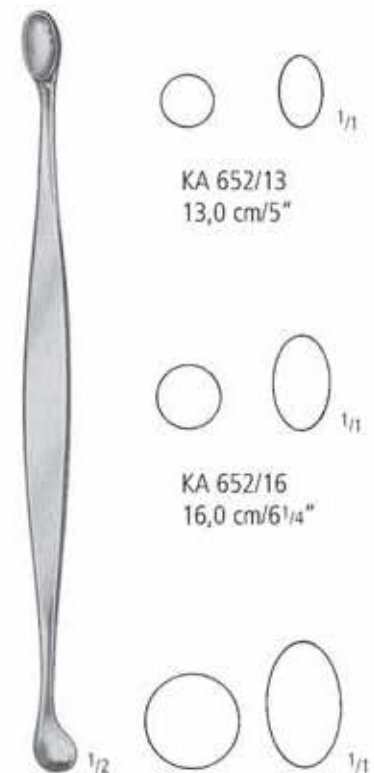

**KA 652/13**  
 13,0 cm/5"



**KA 652/16**  
 16,0 cm/6<sup>1</sup>/<sub>4</sub>"

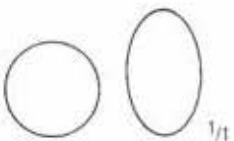

**VOLKMANN** KA 652/20  
 20,0 cm/8"

Scharfe Löffel  
 Bone Curettes  
 Cucharillas cortantes  
 Curettes tranchantes  
 Curette taglienti



**HEMINGWAY**  
 19,0 cm/7 1/2"

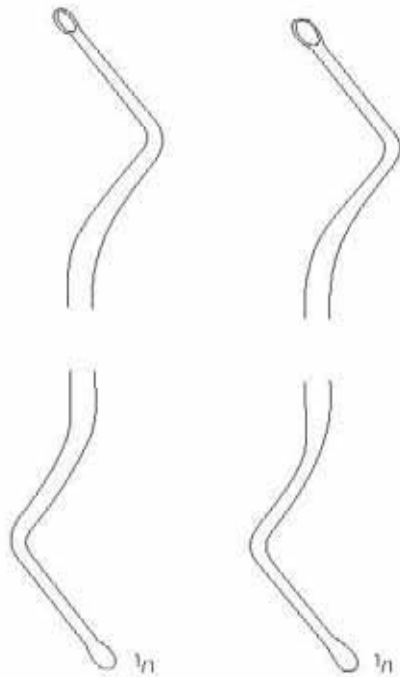

KA 654/11  
 19,0 cm/7 1/2"

KA 654/22  
 19,0 cm/7 1/2"

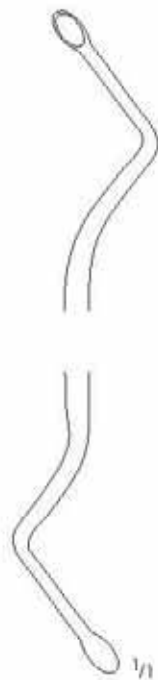

KA 654/33  
 19,0 cm/7 1/2"



**LUCAS**  
 17,0 cm/6 3/4"

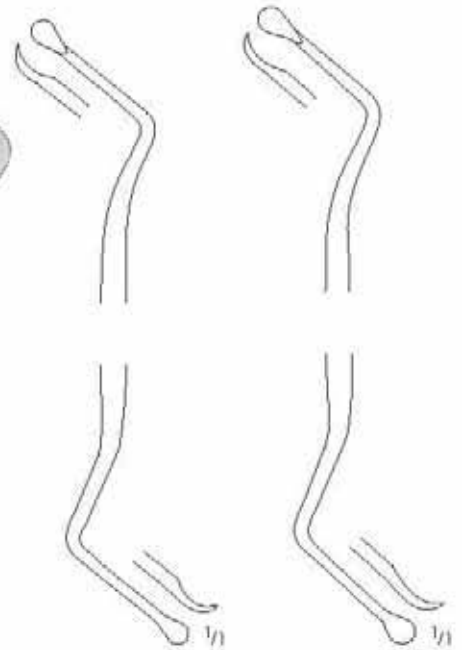

KA 654/85  
 17,0 cm/6 3/4"

KA 654/86  
 17,0 cm/6 3/4"

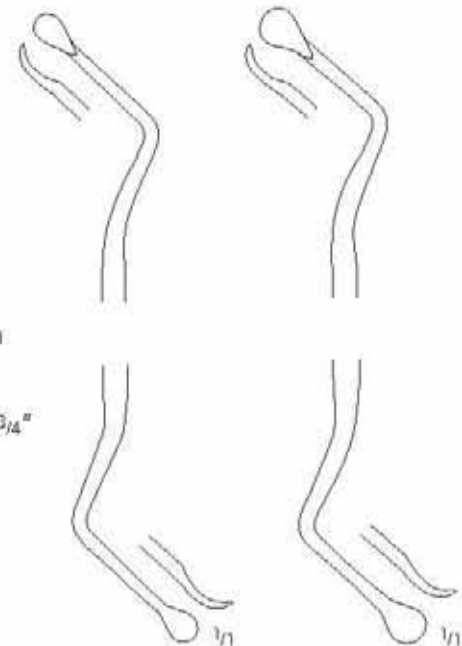

KA 654/87  
 17,0 cm/6 3/4"

KA 654/88  
 17,0 cm/6 3/4"

AA  
 AB  
 AC  
 AD  
 AE  
 AF  
 AG  
 AH  
 AI  
 AJ  
 AK  
 AL  
 AM  
 AN  
 AO  
 AP  
 AR  
 AS  
**KA**  
 KB  
 KC  
 KD  
 KE  
 KF  
 KG  
 KH  
 KI  
 KJ  
 KK  
 KY

Raspatorien  
Raspatories  
Raspadores  
Rugines-Raspatoires  
Periostotomi



KA 660/20  
20,0 cm/8"



KA 661/20  
20,0 cm/8"



KA 662/20  
20,0 cm/8"



KA 664/19  
19,0 cm/7 1/2"



KA 665/18  
18,0 cm/7"



KA 666/18  
18,0 cm/7"



KA 667/18  
18,0 cm/7"



KA 668/18  
18,0 cm/7"

Raspatorien  
Raspatories  
Raspadores  
Rugines-Raspatoires  
Periostotomi

AA  
AB  
AC  
AD  
AE  
AF  
AK  
AL  
AM  
AO  
AP  
AR  
**KA**  
KD  
KU  
KY

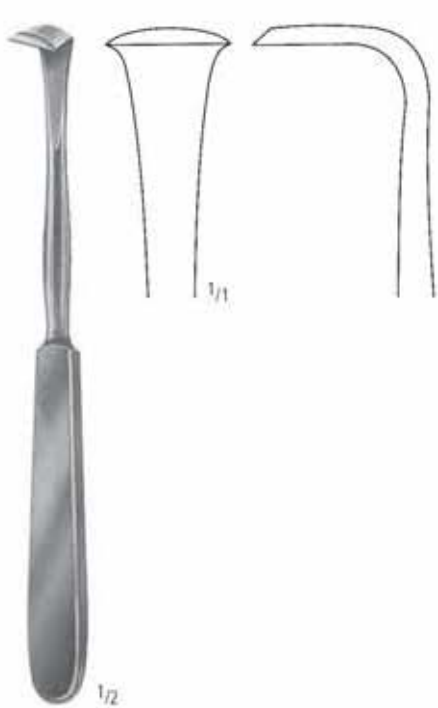

**LANGENBECK**  
KA 671/18  
18,0 cm/7"

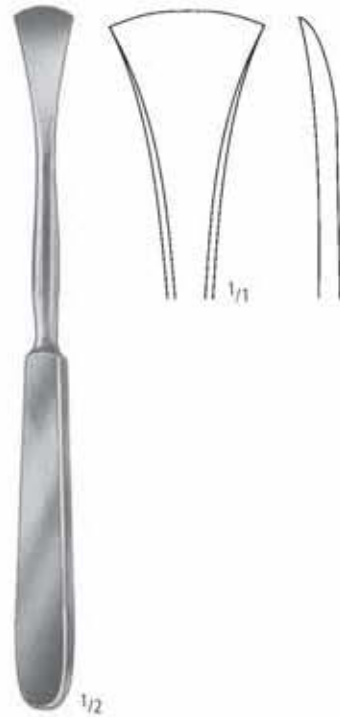

**LANGENBECK**  
KA 672/19  
19,0 cm/7 1/2"



16,0 cm/6 1/4"



**LAMBOTTE**  
21,0 cm/8 1/4"



**FARABEUF**  
KA 678/15  
15,0 cm/6"



**FARABEUF**  
KA 679/15  
15,0 cm/6"

Raspatorien  
 Raspatories  
 Raspadores  
 Rugines-Raspatoires  
 Periostotomi

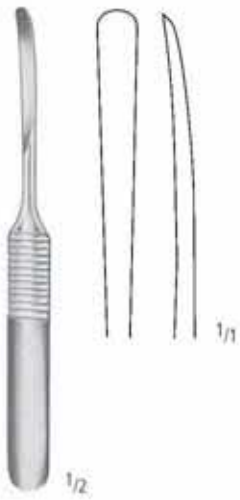

**WILLIGER**  
 KA 680/13  
 13,0 cm/5"

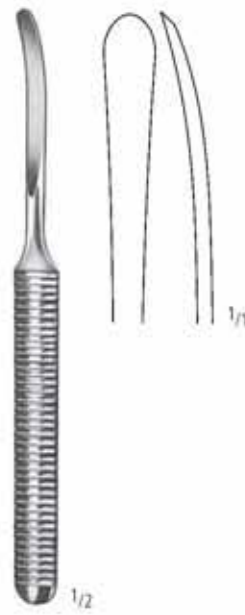

**WILLIGER**  
 KA 680/16  
 16,0 cm/6 1/4"

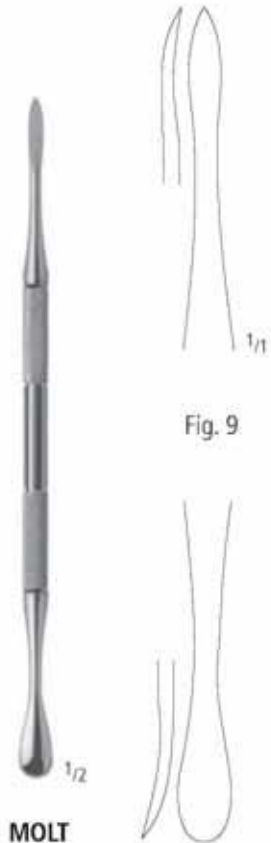

Fig. 9

**MOLT**  
 KA 682/09  
 18,0 cm/7"



Raspatorien  
 Raspatories  
 Raspadores  
 Rugines-Raspatoires  
 Periostotomi

AA  
 AB  
 AC  
 AD  
 AE  
 AF  
 AK  
 AL  
 AM  
 AO  
 AP  
 AR  
 KA  
 KD  
 KU  
 KY



**DOYEN**  
 17,0 cm/6<sup>3</sup>/<sub>4</sub>"

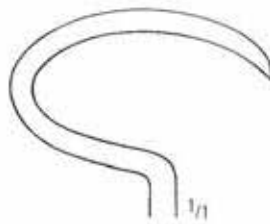

KA 681/17

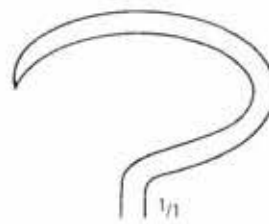

KA 683/17



KA 685/17



KA 687/17



**SEDILLOT**  
 KA 688/21  
 21,0 cm/8<sup>1</sup>/<sub>4</sub>"

Raspatorien  
 Raspatories  
 Raspadores  
 Rugines-Raspatoires  
 Periostotomi



1/2

**SEMB**



KA 689/01  
 17,5 cm/7"



KA 689/02  
 21,0 cm/8 1/4"



KA 689/03  
 17,5 cm/7"



KA 689/04  
 21,0 cm/8 1/4"



KA 689/05  
 20,5 cm/8"



1/2

**ALEXANDER**  
 KA 689/20  
 20,0 cm/8"



1/2

**MATSON**  
 KA 689/22  
 22,0 cm/8 3/4"

Elevatoren  
Elevators  
Elevadores  
Elévateurs  
Elevatori



KA 690/08

**LANGENBECK**  
19,5 cm/7<sup>3</sup>/<sub>4</sub>"



KA 690/10

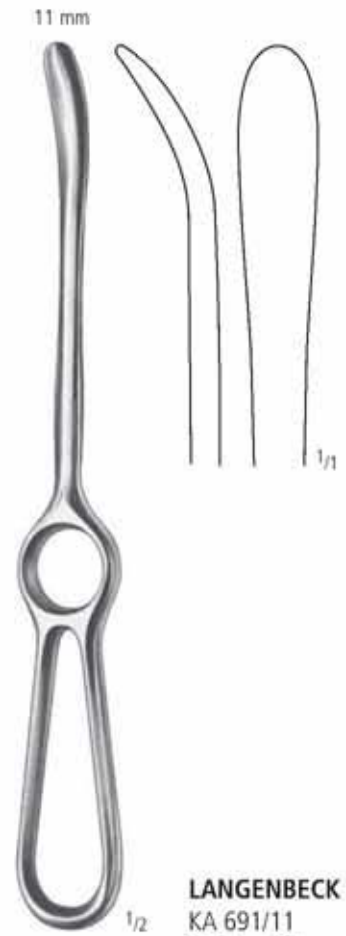

**LANGENBECK**  
KA 691/11  
23,0 cm/9"



**WILLIGER**  
KA 692/16  
16,0 cm/6<sup>1</sup>/<sub>4</sub>"



**WILLIGER**  
KA 694/17  
17,0 cm/6<sup>3</sup>/<sub>4</sub>"

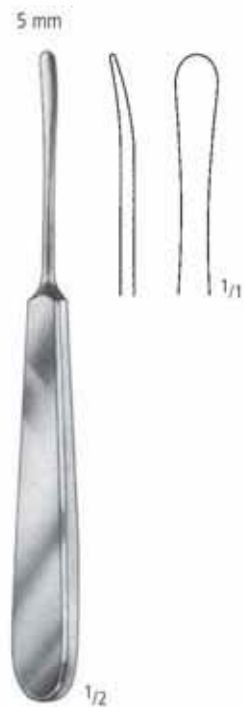

**SEBILLEAU**  
KA 695/05  
17,5 cm/7"

AA  
AB  
AC  
AD  
AE  
AF  
AK  
AL  
AM  
AO  
AP  
AR  
KA  
KD  
KU  
KY

Elevatoren  
Elevators  
Elevadores  
Elévateurs  
Elevatori



KA 696/17  
17,5 cm/6<sup>3</sup>/<sub>4</sub>"



KA 698/16  
16,0 cm/6<sup>1</sup>/<sub>4</sub>"



**ALDERDYCE**  
KA 699/21  
21,0 cm/8<sup>1</sup>/<sub>4</sub>"



**MCDONALD**  
KA 700/19  
19,0 cm/7<sup>1</sup>/<sub>2</sub>"



KA 701/19  
scharf  
sharp  
cortante  
tranchant  
tagliente

KA 702/19  
stumpf  
blunt  
romo  
mousse  
smusso

**FREER**  
19,0 cm/7<sup>1</sup>/<sub>2</sub>"



**FREER**  
KA 703/18  
18,0 cm/7"



**HOEN**

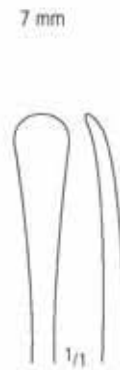

KA 704/07  
16,0 cm/6<sup>1</sup>/<sub>4</sub>"



KA 704/15  
19,0 cm/7<sup>1</sup>/<sub>2</sub>"

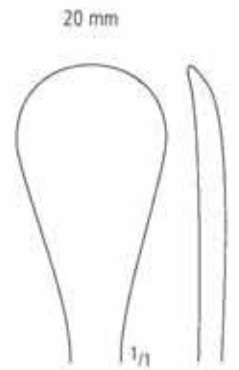

KA 704/20  
19,0 cm/7<sup>1</sup>/<sub>2</sub>"

Elevatori  
Elevators  
Elevadores  
Elévateurs  
Elevatori

AA

AB

AC

AD

AE

AF

AK

AL

AM

AO

AP

AR

**KA**

KD

KU

KY



**ADSON**  
17,0 cm/6<sup>3</sup>/<sub>4</sub>"



KA 705/01



KA 705/02



KA 705/03



KA 705/04



**COBB**  
28,0 cm/11"



KA 708/01



KA 708/02



KA 708/03

Knochenfeilen  
 Bone Files  
 Limas para huesos  
 Limes à os  
 Lime per ossa



KA 710/22  
 22,0 cm/8<sup>3</sup>/<sub>4</sub>"



KA 711/24  
 24,5 cm/9<sup>3</sup>/<sub>4</sub>"



KA 712/28  
 28,0 cm/11"



Raspeln, Stössel  
 Rasps, Tampers  
 Escofinas, Punzón  
 Râpes, Pîlons  
 Raspe, Pestoni



**PUTTI**  
 KA 715/27  
 27,0 cm/10<sup>1</sup>/<sub>2</sub>"



**PUTTI**  
 KA 715/30  
 30 cm/12"



15,5 cm/6"

Ø 2 mm  
 KA 720/02

Ø 3 mm  
 KA 720/03

Ø 4 mm  
 KA 720/04

Ø 5 mm  
 KA 720/05

Ø 6 mm  
 KA 720/06

Ø 8 mm  
 KA 720/08

Ø 10 mm  
 KA 720/10

AA  
 AB  
 AC  
 AD  
 AE  
 AF  
 AK  
 AL  
 AM  
 AO  
 AP  
 AR  
 KA  
 KD  
 KU  
 KY

Knochenhalte­zangen  
 Bone Holding Forceps  
 Pinzas para huesos  
 Daviers porte-os  
 Tenaglie per ossa



KA 730/00  
 14,0 cm/5 1/2"



KA 731/00  
 13,5 cm/5 1/4"



KA 732/00  
 12,0 cm/4 3/4"

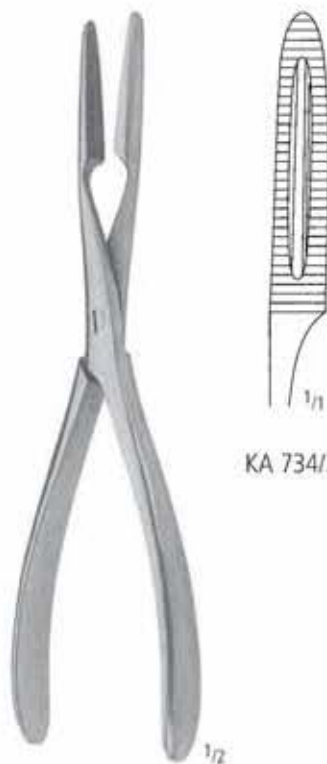

KA 734/20

20,0 cm/8"



KA 735/20

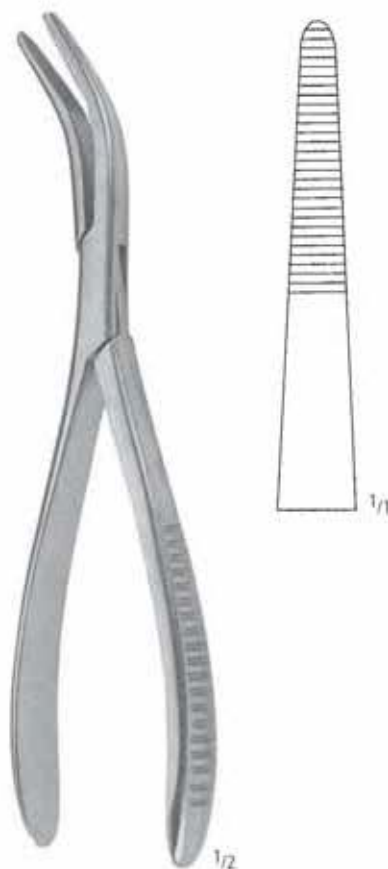

**VAN BUREN**  
 KA 736/23  
 23,0 cm/9"

Meniskus- und Knorpelfasszangen  
 Meniscus- and Cartilage Forceps  
 Pinzas para cartilago y menisco  
 Daviers à ménisques et cartilage  
 Pinze per afferrare menisci e cartilagine

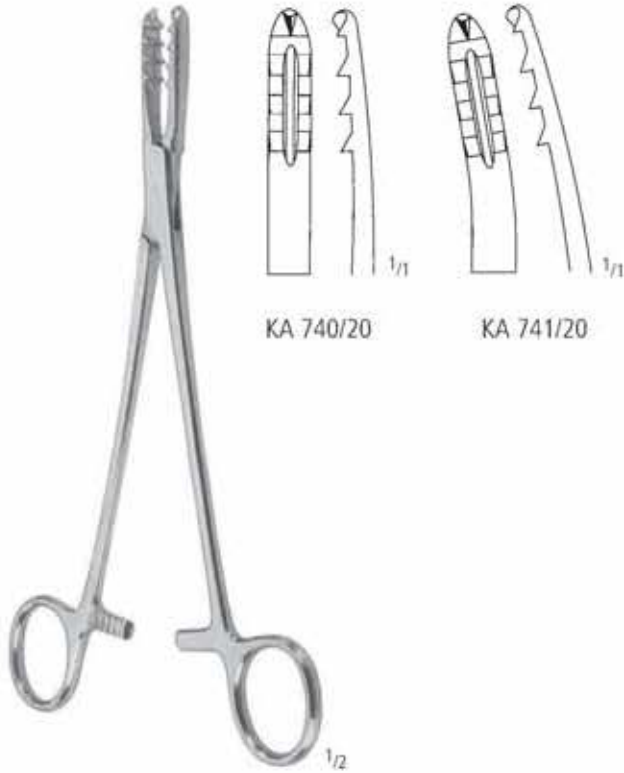

**BIRCHER-GANSKE**  
 20,0 cm/8"

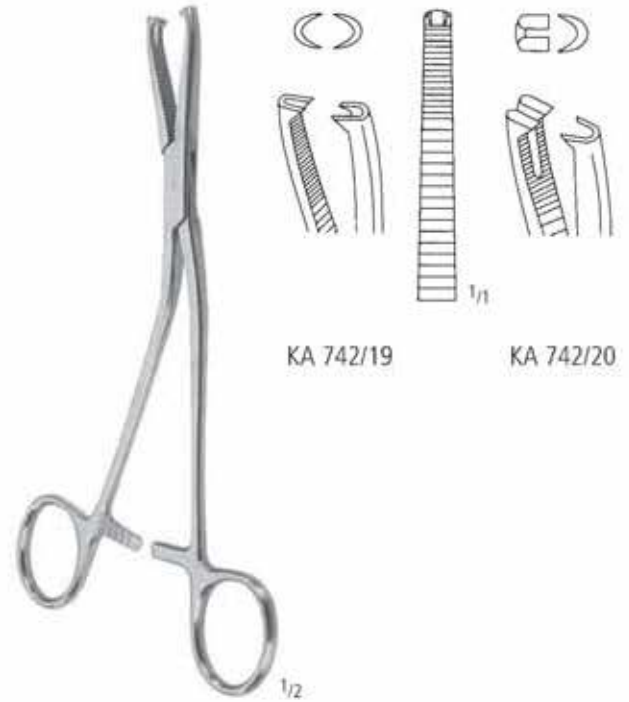

**DINGMANN**  
 19,0 cm/7 1/2"



**MARTIN**  
 KA 744/19  
 19,0 cm/7 1/2"



KA 745/13  
 13,5 cm/5 1/4"

AA  
 AB  
 AC  
 AD  
 AE  
 AF  
 AK  
 AL  
 AM  
 AO  
 AP  
 AR  
 KA  
 KD  
 KU  
 KY

Knochenhalte­zangen  
 Bone Holding Forceps  
 Pinzas para huesos  
 Daviers porte-os  
 Tenaglie per ossa



KA 747/21  
 21,0 cm/8 1/4"



**LEWIN**  
 KA 750/17  
 17,5 cm/7"

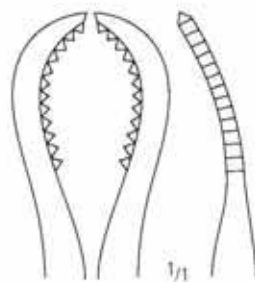

KA 752/16  
 16,0 cm/6 1/4"

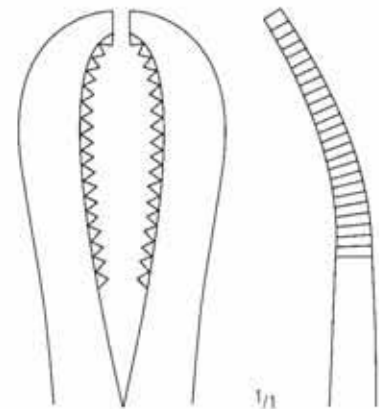

KA 752/24  
 24,0 cm/9 1/2"

Knochenhalte­zangen  
 Bone Holding Forceps  
 Pinzas para huesos  
 Daviers porte-os  
 Tenaglie per ossa

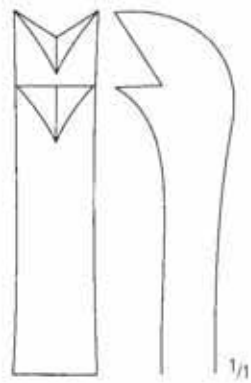

**FERGUSSON**  
 KA 754/21  
 21,0 cm/8<sup>1</sup>/<sub>4</sub>"

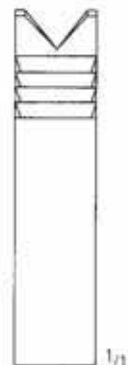

**LANGENBECK**  
 KA 756/21  
 21,0 cm/8<sup>1</sup>/<sub>4</sub>"



**KA 757/20**  
 20,0 cm/8"

AA  
 AB  
 AC  
 AD  
 AE  
 AF  
 AK  
 AL  
 AM  
 AO  
 AP  
 AR  
**KA**  
 KD  
 KU  
 KY

Knochenhalte­zangen  
Bone Holding Forceps  
Pinzas para huesos  
Daviers porte-os  
Tenaglie per ossa

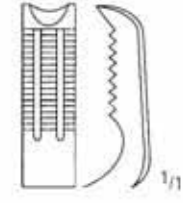

KA 758/17  
17,0 cm/6<sup>3</sup>/<sub>4</sub>"

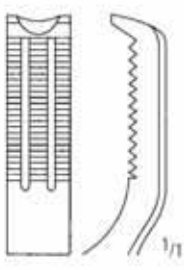

KA 758/21  
21,0 cm/8<sup>1</sup>/<sub>2</sub>"

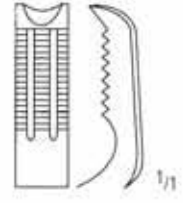
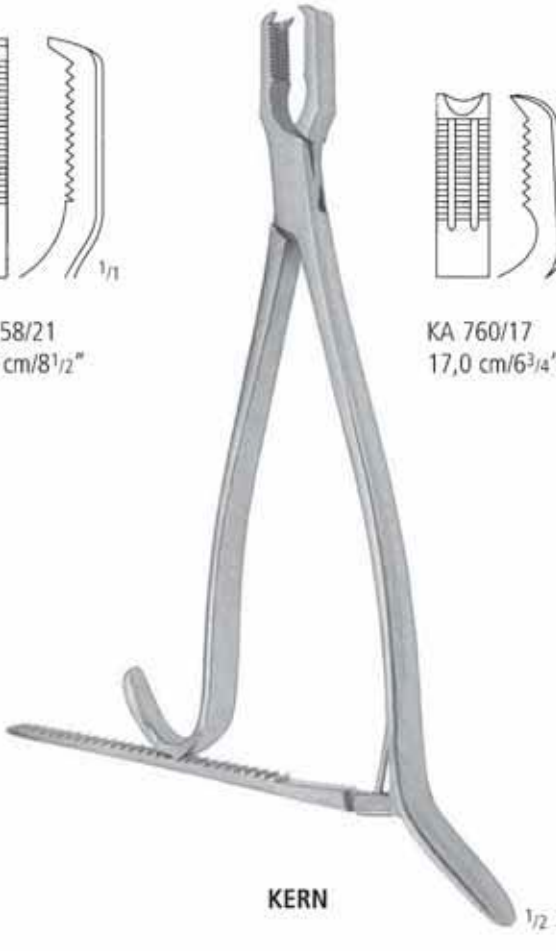

KA 760/17  
17,0 cm/6<sup>3</sup>/<sub>4</sub>"

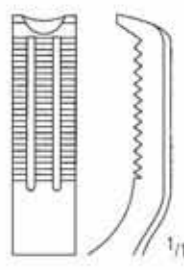

KA 760/21  
21,0 cm/8<sup>1</sup>/<sub>2</sub>"

**KERN**

**KERN**

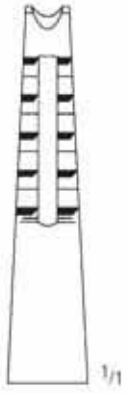

**SEMB**  
KA 762/19  
19,0 cm/7<sup>1</sup>/<sub>2</sub>"



**SEMB**  
KA 763/19  
19,0 cm/7<sup>1</sup>/<sub>2</sub>"



Knochenhalte­zangen  
Bone Holding Forceps  
Pinzas para huesos  
Daviers porte-os  
Tenaglie per ossa



LANE

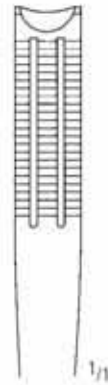

KA 766/33  
33,0 cm/13"

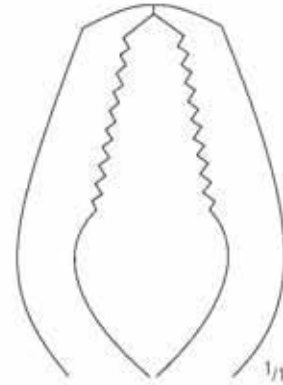

mit Sperre  
with ratchet  
con cremallera  
avec crémaillère  
con cremagliera

KA 768/33  
33,0 cm/13"

ohne Sperre  
without ratchet  
sin cremallera  
sans crémaillère  
senza cremagliera

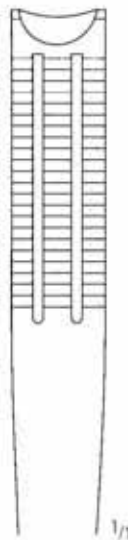

KA 768/45  
45,0 cm/17<sup>3</sup>/<sub>4</sub>"

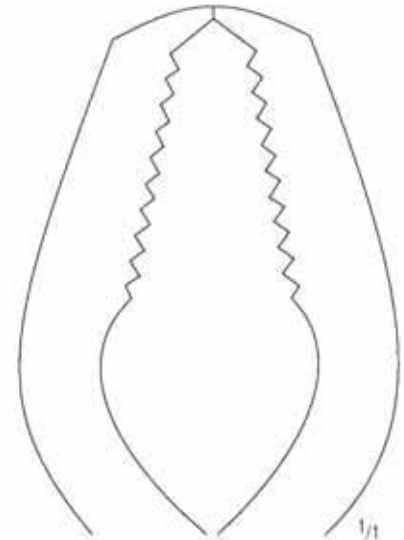

ohne Sperre  
without ratchet  
sin cremallera  
sans crémaillère  
senza cremagliera

AA  
AB  
AC  
AD  
AE  
AF  
AK  
AL  
AM  
AO  
AP  
AR  
KA  
KD  
KU  
KY

Knochenhalte­zangen  
 Bone Holding Forceps  
 Pinzas para huesos  
 Daviers porte-os  
 Tenaglie per ossa



**FARABEUF-LAMBOTTE**  
 KA 769/26  
 26,0 cm/10<sup>1</sup>/<sub>4</sub>"



**FARABEUF**

KA 770/23  
 23,0 cm/9"

KA 770/26  
 26,0 cm/10<sup>1</sup>/<sub>4</sub>"

Knochenhalte­zangen  
Bone Holding Forceps  
Pinzas para huesos  
Daviers porte-os  
Tenaglie per ossa



**VERBRUGGE**

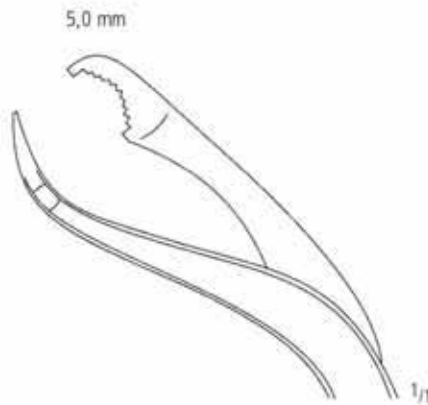

KA 771/05  
17,5 cm/6<sup>3</sup>/<sub>4</sub>"

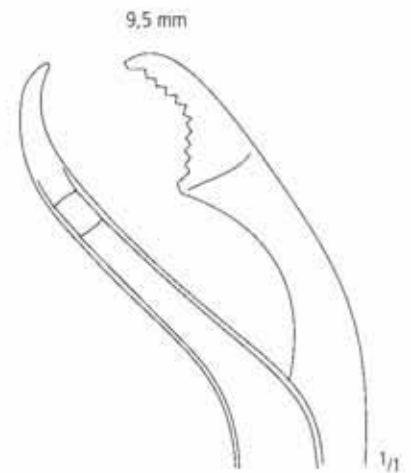

KA 771/10  
25,0 cm/10"



KA 771/11  
26,0 cm/10<sup>1</sup>/<sub>4</sub>"

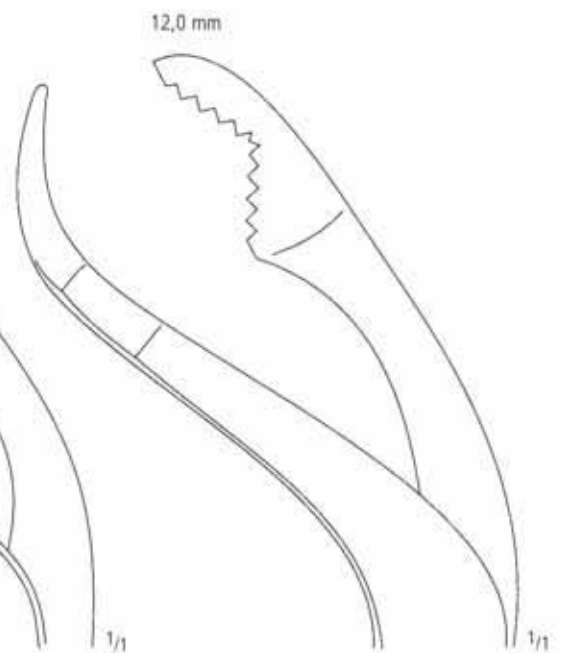

KA 771/12  
27,0 cm/11"

AA  
AB  
AC  
AD  
AE  
AF  
AK  
AL  
AM  
AO  
AP  
AR  
KA  
KD  
KU  
KY

Knochenhaltezangen  
 Bone Holding Forceps  
 Pinzas para huesos  
 Daviers porte-os  
 Tenaglie per ossa

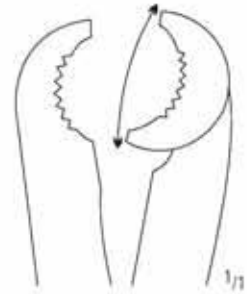
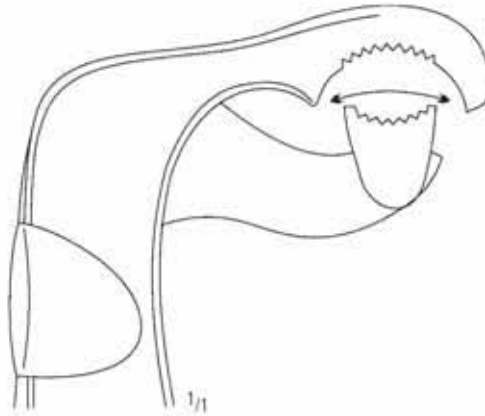

**LAMBOTTE**

KA 772/22 - 22,0 cm/8<sup>3</sup>/<sub>4</sub>"  
 KA 772/26 - 26,0 cm/10<sup>1</sup>/<sub>4</sub>"  
 KA 772/33 - 33,0 cm/13"

**LAMBOTTE**

KA 773/19 - 19,0 cm/7<sup>1</sup>/<sub>2</sub>"  
 KA 773/23 - 23,0 cm/9"  
 KA 773/26 - 26,0 cm/10<sup>1</sup>/<sub>4</sub>"

**LAMBOTTE**

KA 774/22 - 22,0 cm/8<sup>3</sup>/<sub>4</sub>"  
 KA 774/27 - 27,0 cm/10<sup>1</sup>/<sub>2</sub>"  
 KA 774/30 - 30,0 cm/12"

ORTHOPÄDIE ORTHOPAEDIC ORTOPEDIA ORTHOPEDIE ORTOPEDIA

Knochenhalte­zangen  
 Bone Holding Forceps  
 Pinzas para huesos  
 Daviers porte-os  
 Tenaglie per ossa

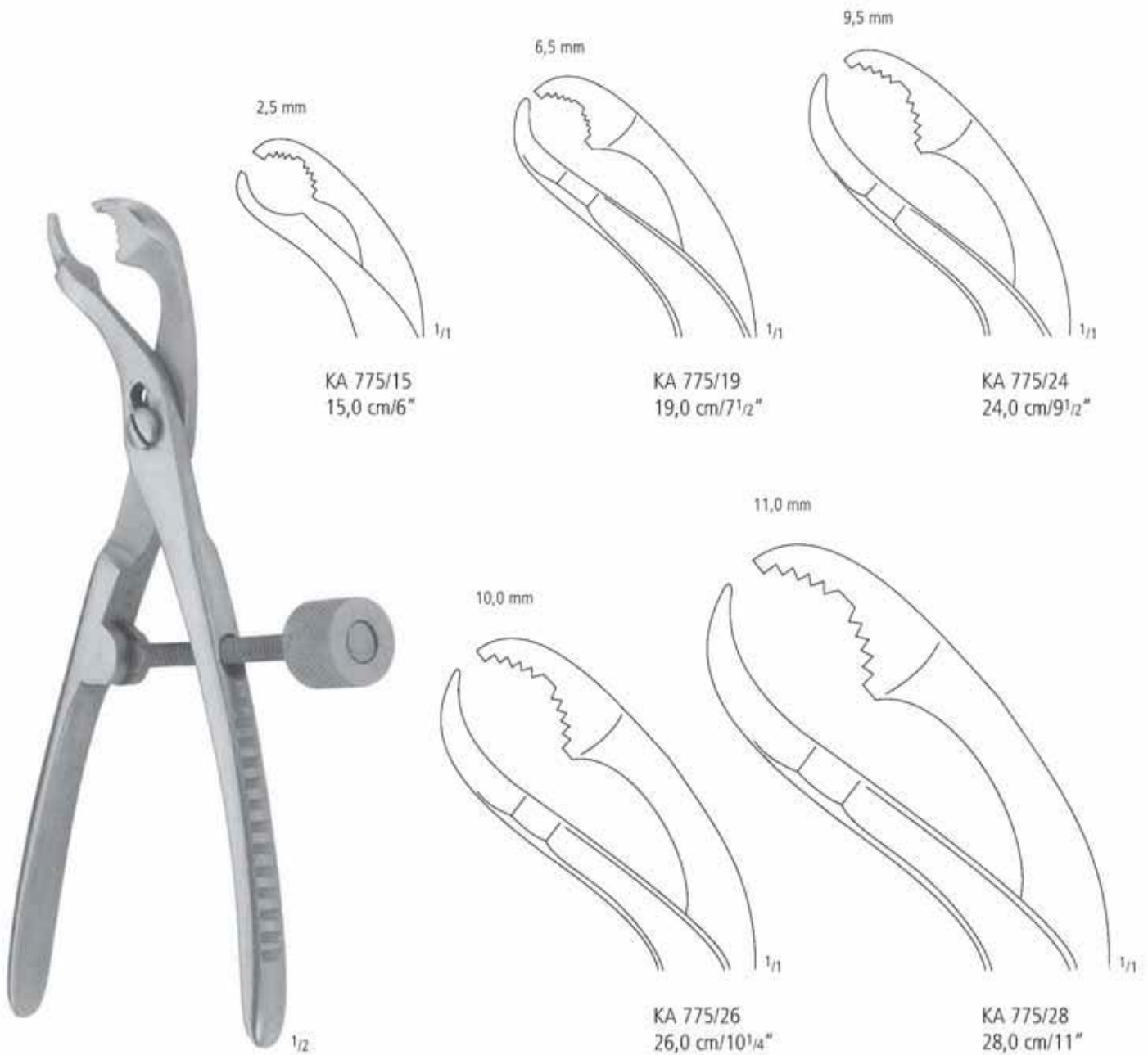

AA  
 AB  
 AC  
 AD  
 AE  
 AF  
 AK  
 AL  
 AM  
 AN  
 AP  
 AR  
 KA  
 KD  
 KU  
 KY

Knochenhalte­zangen  
 Bone Holding Forceps  
 Pinzas para huesos  
 Daviers porte-os  
 Tenaglie per ossa



KA 777/23  
 23,0 cm/9"



KA 778/23  
 23,0 cm/9"

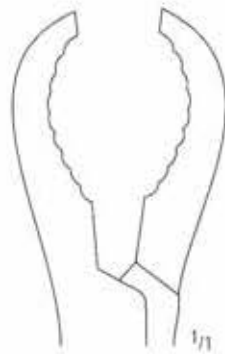

KA 777/25  
 25,0 cm/10"

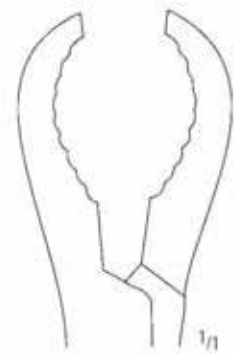

KA 778/25  
 25,0 cm/10"

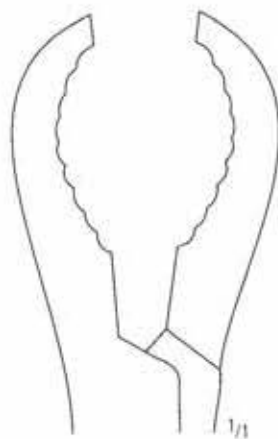

KA 777/28  
 28,0 cm/11"

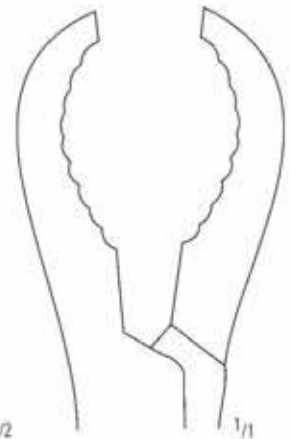

KA 778/28  
 28,0 cm/11"



**ULRICH**



**ULRICH**



Amputationsschild  
 Amputation Shield  
 Retractor para amputación  
 Retracteur pour amputation  
 Retrattore per amputazione



**PERCY**  
 KA 780/00

AA  
 AB  
 AC  
 AD  
 AE  
 AF  
 AK  
 AL  
 AM  
 AO  
 AP  
 AR  
**KA**  
 KD  
 KU  
 KY

Sehnenfassinstrumente  
 Tendon Seizing Instruments  
 Instrumentos para coger tendones  
 Instruments pour saisir les tendons  
 Strumenti per afferrare tendini



KA 785/15  
15,0 cm/6"



1/1

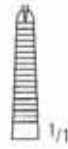

1/1

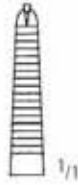

1/1

KA 785/19  
19,0 cm/7<sup>1</sup>/<sub>2</sub>"

KA 785/24  
24,0 cm/9<sup>1</sup>/<sub>2</sub>"

**BRAND**

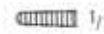

1/1

**CAROLL**  
 KA 786/11  
 11,0 cm/4"

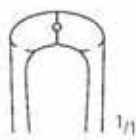

1/1

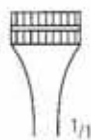

1/1

**STEINMANN**  
 KA 787/16  
 16,0 cm/6<sup>1</sup>/<sub>4</sub>"



1/1

**KLEINERT-KUTZ**  
 KA 788/20  
 20,0 cm/8"

Sehnenstripper  
Tendon Stripper  
Separadores para tendones  
Instruments à écorcher les tendons  
Scollatendini



biegsam  
malleable  
maleable  
malléable  
malleabile

**BUNNELL**  
KA 790/23  
23,0 cm/9"



4,0 mm  
KA 791/40

4,5 mm  
KA 791/45

5,5 mm  
KA 791/55

23,0 cm/9"  
biegsam  
malleable  
maleable  
malléable  
malleabile



KA 792/01

KA 792/02

KA 792/03

KA 792/04

KA 792/05

**BUNNELL**  
15,0 cm/6"

AA  
AB  
AC  
AD  
AE  
AF  
AK  
AL  
AM  
AO  
AP  
AR  
KA  
KD  
KU  
KY

Wund- und Meniskushaken  
 Knee Retractors  
 Separadores para rodilla  
 Ecarteurs pour le genou  
 Divaricatori per il ginocchio

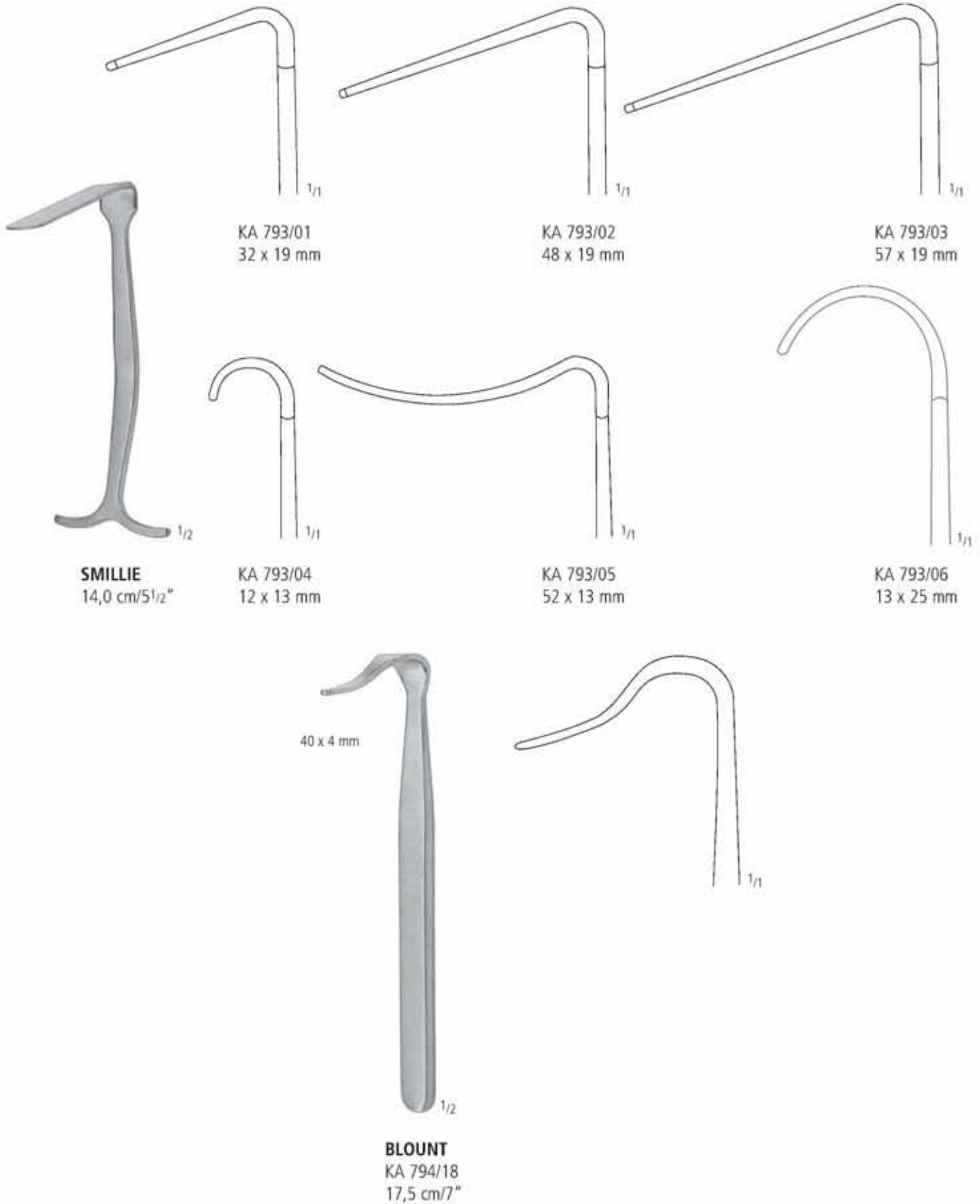

Meniskotome  
Meniscotomy Knives  
Bisturios para meniscos  
Bistouris à ménisques  
Meniscotomi

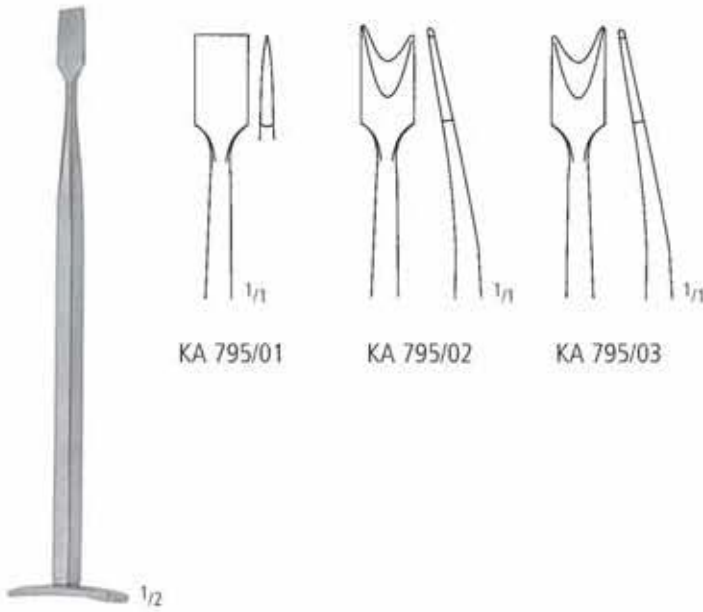

**SMILLIE**  
17,0 cm/6<sup>3</sup>/<sub>4</sub>"

KA 795/01

KA 795/02

KA 795/03



**SALENIUS**  
KA 796/01  
22,0 cm/8<sup>3</sup>/<sub>4</sub>"



**SALENIUS**  
KA 796/02  
22,0 cm/8<sup>3</sup>/<sub>4</sub>"



**NEFF**  
KA 797/01  
22,0 cm/8<sup>3</sup>/<sub>4</sub>"



**NEFF**  
KA 797/02  
22,0 cm/8<sup>3</sup>/<sub>4</sub>"



KA 798/01



KA 798/02



**BIRCHER**  
19,0 cm/7<sup>1</sup>/<sub>2</sub>"

AA  
AB  
AC  
AD  
AE  
AF  
AK  
AL  
AM  
AO  
AP  
AR  
**KA**  
KD  
KU  
KY

Hohlmeisselzangen  
 Bone Rongeurs  
 Pinzas-gubias  
 Pincès-gouges  
 Pinze-sgorbie

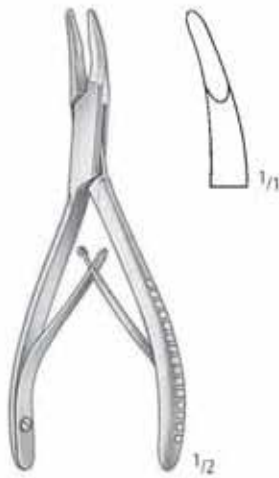

**MINI-FRIEDMAN**  
 KA 800/12  
 12,0 cm/5"



**FRIEDMAN**  
 KA 800/14  
 14,0 cm/5 1/2"

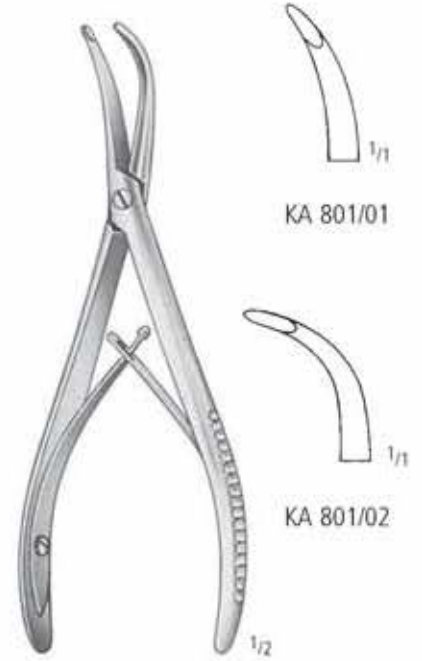

**STELLBRINK**  
 17,0 cm/6 3/4"

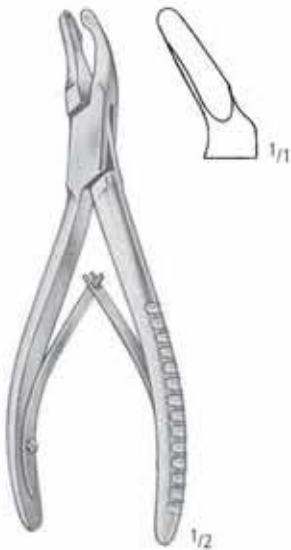

**CLEVELAND**  
 KA 802/14  
 14,0 cm/5 1/2"

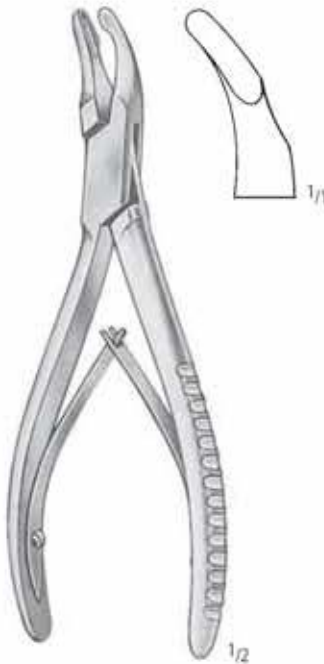

**CLEVELAND**  
 KA 802/17  
 17,0 cm/6 3/4"

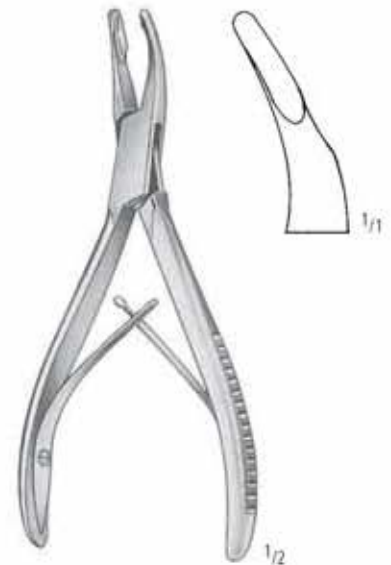

**UNIVERSAL**  
 KA 803/13  
 13,5 cm/5 1/4"



Hohlmeisselzangen  
 Bone Rongeurs  
 Pinzas-gubias  
 Pincès-gouges  
 Pinze-sgorbie

AA  
AB  
AC  
AD  
AE  
AF  
AK  
AL  
AM  
AO  
AP  
AR  
KA  
KD  
KU  
KY



**MEAD**  
 16,5 cm/6 1/2"



**HARTMANN**  
 KA 807/18  
 18,5 cm/7 1/3"

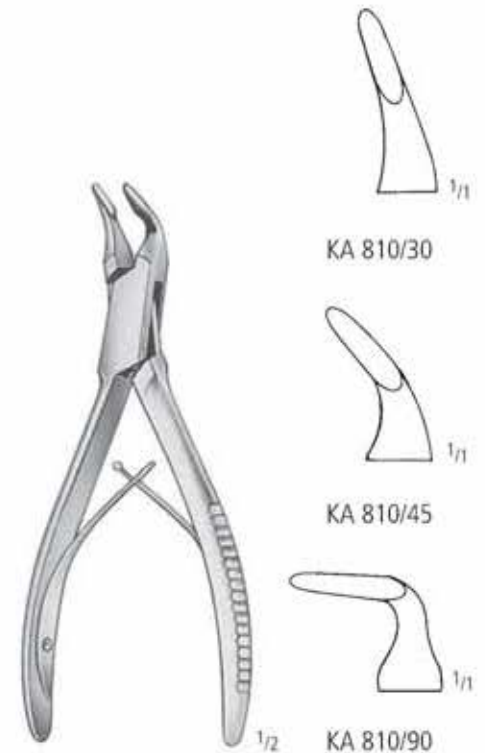

**BLUMENTHAL**  
 15,5 cm/6"

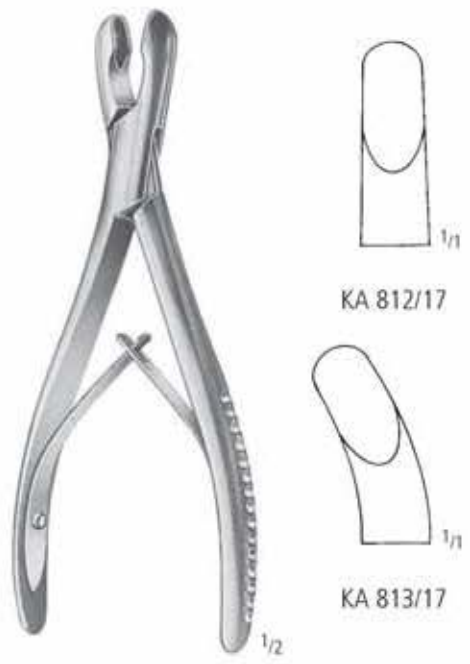

**LUER**  
 17,0 cm/6 3/4"

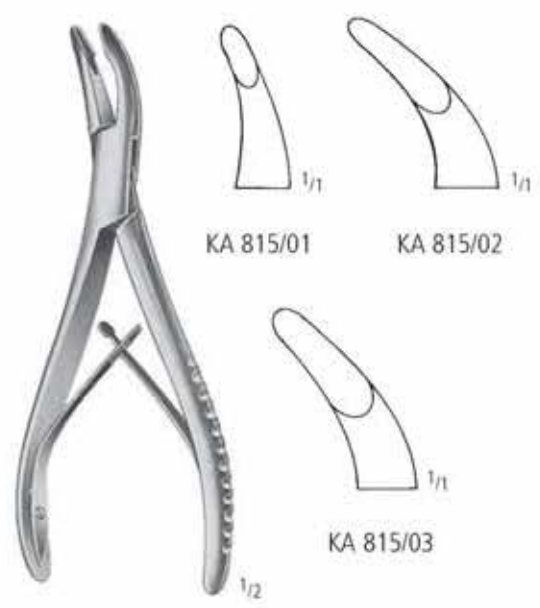

**LUER**  
 15,0 cm/6"

Hohlmeisselzangen  
 Bone Rongeurs  
 Pinzas-gubias  
 Pincès-gouges  
 Pinze-sgorbie



**LEMPERT**  
 KA 816/19  
 19,0 cm/7 1/2"



**BACON**  
 KA 819/20  
 20,0 cm/8"



**MARQUARDT**  
 KA 821/20  
 20,0 cm/8"



**MAYFIELD**  
 KA 823/17  
 17,0 cm/6 3/4"

Hohlmeißelzangen  
 Bone Rongeurs  
 Pinzas-gubias  
 Pincas-gouges  
 Pinze-sgorbie

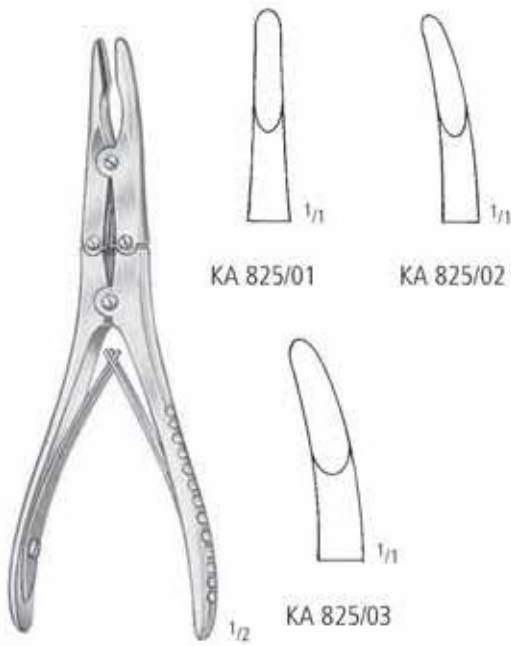

**BÖHLER**  
 15,0 cm/6"

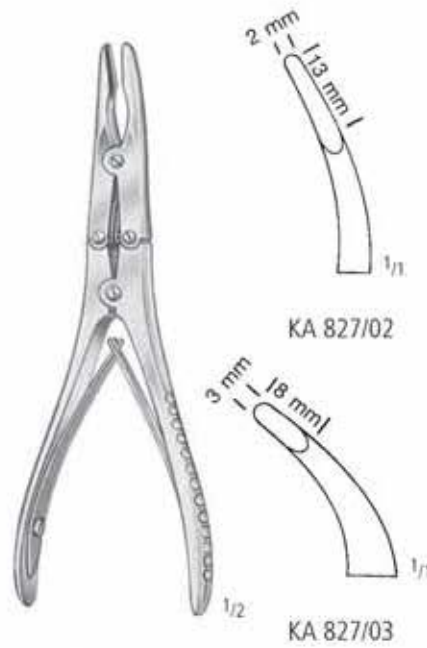

**KLEINERT-KUTZ**  
 15,0 cm/6"



**RUSKIN-MINI**  
 KA 829/15  
 15,0 cm/6"



**BEYER**  
 KA 830/18  
 18,0 cm/7"



**ZAUFAL-JANSEN**  
 KA 835/18  
 18,0 cm/7"



**RUSKIN**  
 KA 836/18  
 18,0 cm/7"

AA  
 AB  
 AC  
 AD  
 AE  
 AF  
 AK  
 AL  
 AM  
 AO  
 AP  
 AR  
**KA**  
 KD  
 KU  
 KY

Hohlmeisselzangen  
 Bone Rongeurs  
 Pinzas-gubias  
 Pincas-gouges  
 Pinze-sgorbie

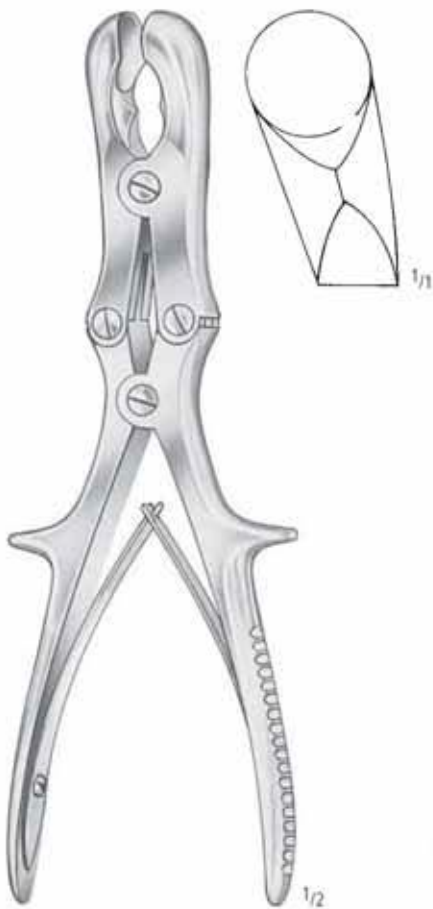

**SEMB**  
 KA 838/22  
 22,5 cm/9"



**STILLE**  
 KA 840/23  
 23,0 cm/9"



**STILLE-RUSKIN**  
 KA 841/23  
 23,0 cm/9"

Hohlmeisselzangen  
 Bone Rongeurs  
 Pinzas-gubias  
 Pincis-gouges  
 Pinze-sgorbie

AA  
AB  
AC  
AD  
AE  
AF  
AK  
AL  
AM  
AO  
AP  
AR  
KA  
KD  
KU  
KY



**ROETTGEN-RUSKIN**  
 KA 845/24  
 24,0 cm/9<sup>1</sup>/<sub>2</sub>"



**LEKSELL-STILLE**  
 24,0 cm/9<sup>1</sup>/<sub>2</sub>"

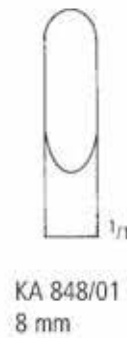

KA 848/01  
 8 mm

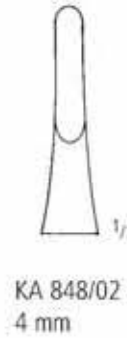

KA 848/02  
 4 mm



**STILLE-LUER**  
 22,0 cm/8<sup>3</sup>/<sub>4</sub>"

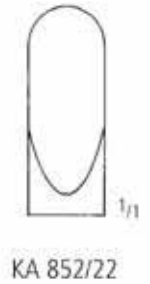

KA 852/22

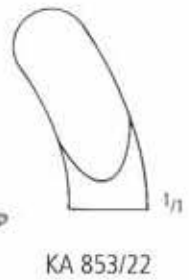

KA 853/22



Hohlmeisselzangen  
 Bone Rongeurs  
 Pinzas-gubias  
 Pincès-gouges  
 Pinze-sgorbie



**SAUERBRUCH**  
 30,0 cm/12"



**FRYKHOLM**  
 KA 859/23  
 23,0 cm/9"

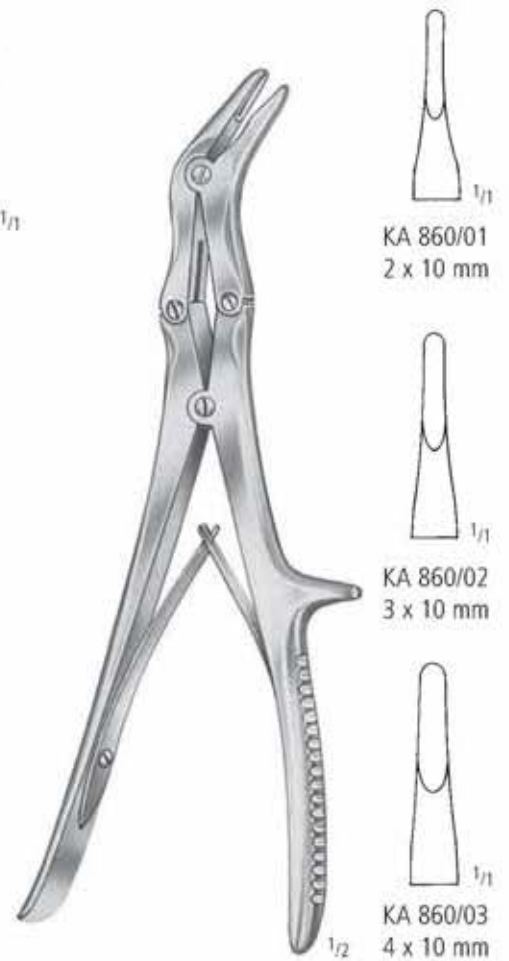

**ECHLIN**  
 23,0 cm/9"



Hohlmeisselzangen  
 Bone Rongeurs  
 Pinzas-gubias  
 Pincis-gouges  
 Pinze-sgorbie



**RUSKIN**  
 KA 862/23  
 23,0 cm/9"



**SMITH-PETERSON**  
 24,0 cm/9 1/2"



3,0 mm  
 KA 863/03

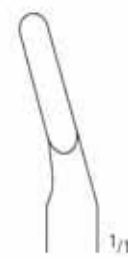

4,0 mm  
 KA 863/04



5,0 mm  
 KA 863/05



3,0 mm  
 KA 863/13



4,0 mm  
 KA 863/14



5,0 mm  
 KA 863/15

AA  
 AB  
 AC  
 AD  
 AE  
 AF  
 AK  
 AL  
 AM  
 AO  
 AP  
 AR  
**KA**  
 KD  
 KU  
 KY

Hohlmeißelzangen  
 Bone Rongeurs  
 Pinzas-gubias  
 Pincès-gouges  
 Pinze-sgorbie

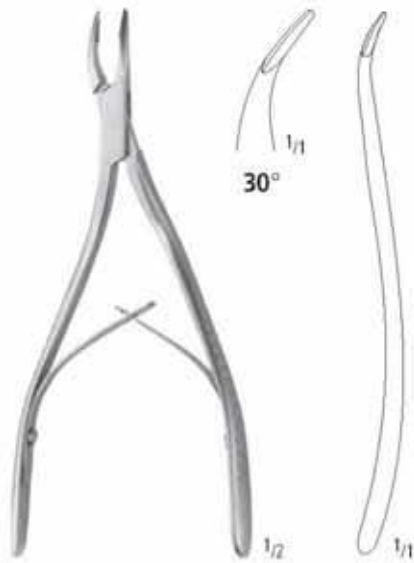

**MICRO-FRIEDMAN**  
 KA 865/14  
 14,5 cm/5<sup>3</sup>/<sub>4</sub>"

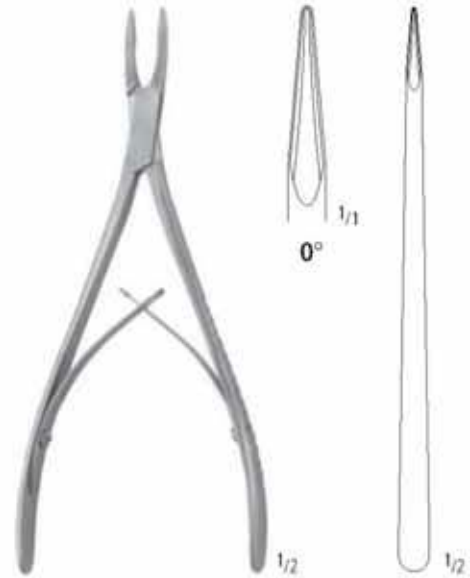

**MICRO-FRIEDMAN**  
 KA 866/15  
 15,0 cm/6"

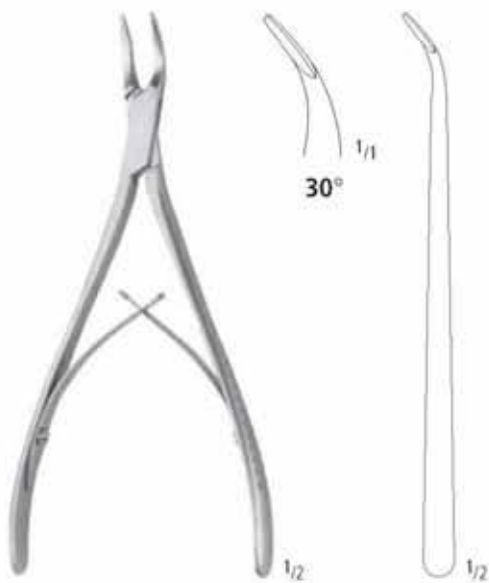

**MICRO-FRIEDMAN**  
 KA 867/15  
 15,0 cm/6"

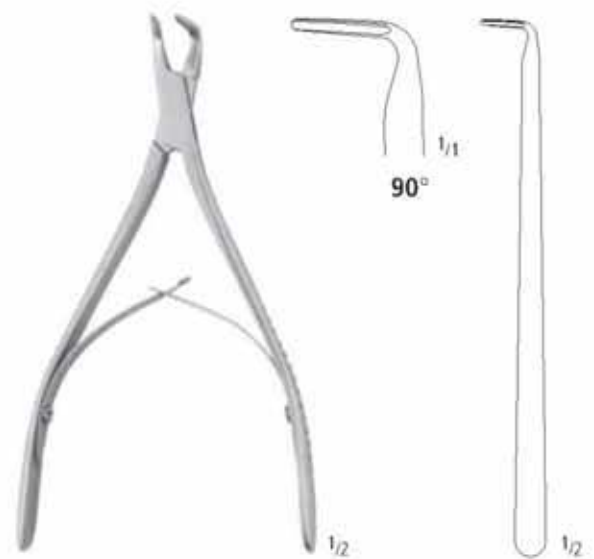

**MICRO-FRIEDMAN**  
 KA 868/15  
 14,5 cm/5<sup>3</sup>/<sub>4</sub>"

Knochensplitterzangen  
 Bone Cutting Forceps  
 Pinzas cortantes para huesos  
 Pinces coupantes à os  
 Cesioie per ossa

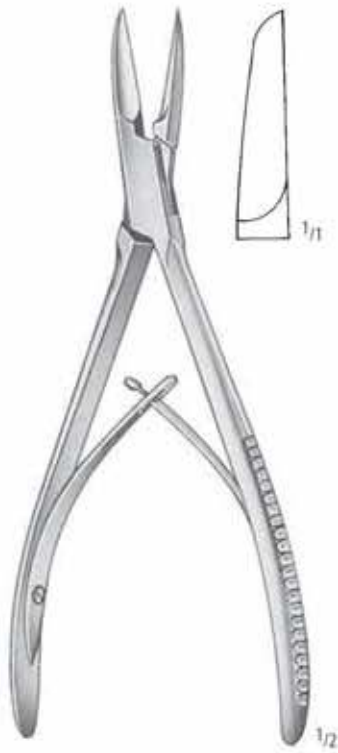

**COTTLE KAZANJIAN**  
 KA 870/19  
 19,0 cm/7<sup>1</sup>/<sub>2</sub>"

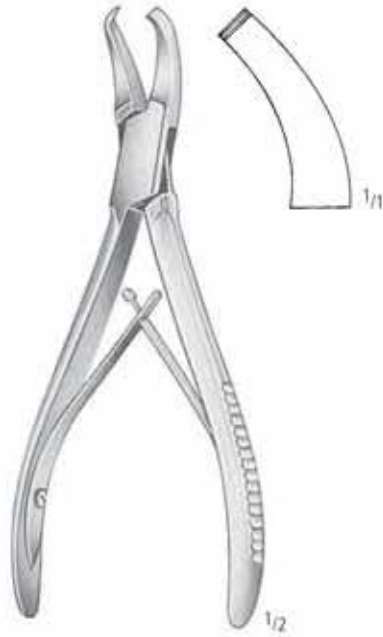

**CLEVELAND-GARDNER**  
 KA 872/16  
 18,0 cm/6<sup>1</sup>/<sub>4</sub>"



**MARKWALDER**  
 KA 874/20  
 20,0 cm/8"

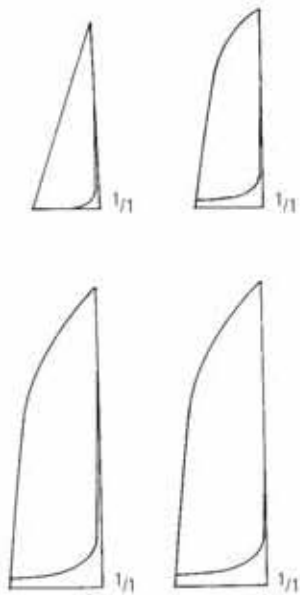

**LISTON**  
 KA 880/14 14,0 cm/5<sup>1</sup>/<sub>2</sub>"  
 KA 880/17 17,0 cm/6<sup>3</sup>/<sub>4</sub>"  
 KA 880/19 19,0 cm/7<sup>1</sup>/<sub>2</sub>"  
 KA 880/22 22,0 cm/8<sup>3</sup>/<sub>4</sub>"

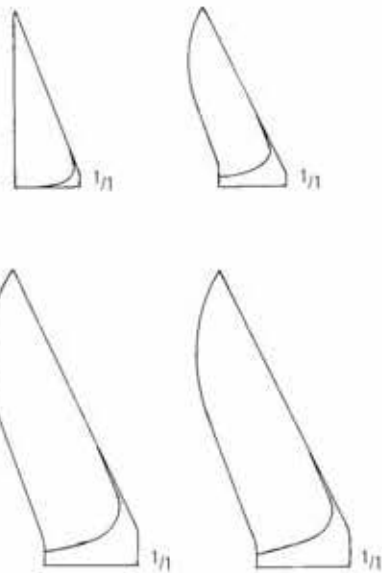

**LITTAUER-LISTON**  
 KA 882/15  
 15,0 cm/6"

KA 880/14  
 KA 880/17  
 KA 880/19  
 KA 880/22

KA 881/14  
 KA 881/17  
 KA 881/19  
 KA 881/22

AA  
 AB  
 AC  
 AD  
 AE  
 AF  
 AK  
 AL  
 AM  
 AO  
 AP  
 AR  
 KA  
 KD  
 KU  
 KY

Knochensplitterzangen  
 Bone Cutting Forceps  
 Pinzas cortantes para huesos  
 Pincas coupantes à os  
 Cesioie per ossa



**CLEVELAND**  
 KA 884/15  
 15,0 cm/6"



**CLEVELAND**  
 KA 884/17  
 17,0 cm/6<sup>3</sup>/<sub>4</sub>"



KA 885/12  
 10,0 cm/4"

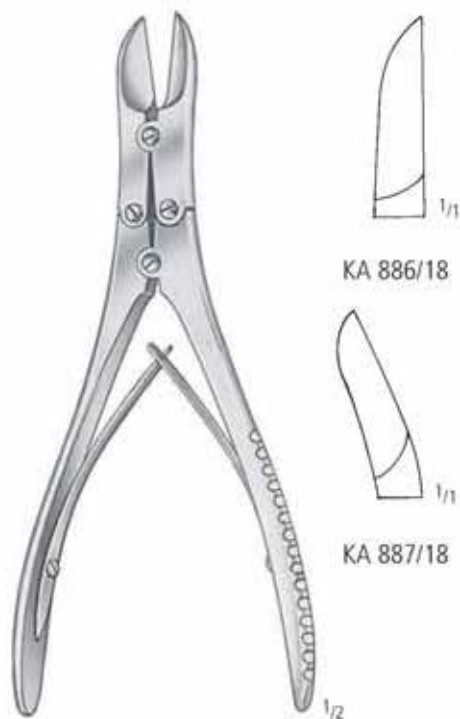

**RUSKIN-LISTON**  
 18,5 cm/7<sup>1</sup>/<sub>4</sub>"



KA 886/18

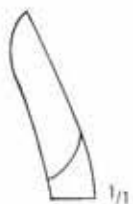

KA 887/18



**MC INDOE**  
 KA 888/17  
 17,5 cm/7"



**WALTON-LISTON**  
 KA 889/01  
 15,0 cm/6"

Knochensplitterzangen  
 Bone Cutting Forceps  
 Pinzas cortantes para huesos  
 Pincas coupantes à os  
 Cesioie per ossa

AA  
AB  
AC  
AD  
AE  
AF  
AK  
AL  
AM  
AO  
AP  
AR  
KA  
KD  
KU  
KY



KA 890/00

KA 890/30

KA 890/90

**STILLE-LISTON**  
 27,0 cm/10<sup>1</sup>/<sub>2</sub>"



**LISTON-KEY (TUDOR-EDWARDS)**  
 KA 892/27  
 27,0 cm/10<sup>1</sup>/<sub>2</sub>"

Knochensplitterzangen  
 Bone Cutting Forceps  
 Pinzas cortantes para huesos  
 Pinces coupantes à os  
 Cesioie per ossa



**SEMB**  
 KA 893/24  
 24,0 cm/9<sup>1</sup>/<sub>2</sub>"

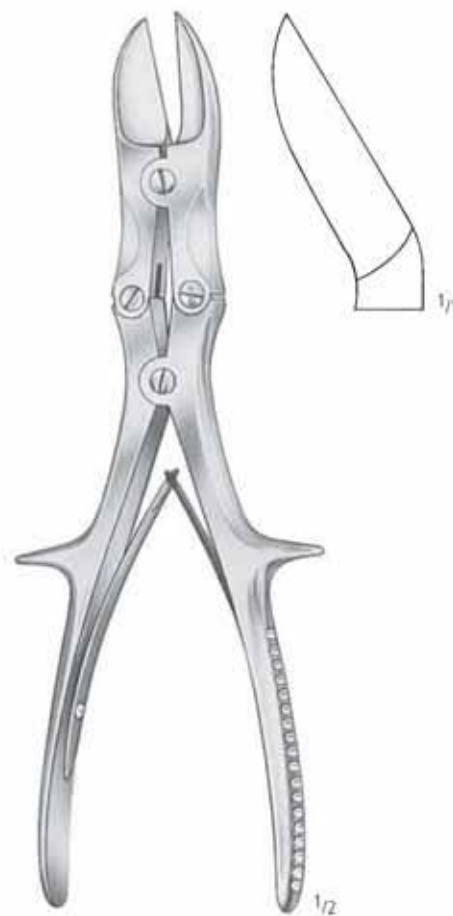

**LISTON**  
 KA 894/23  
 23,5 cm/9<sup>1</sup>/<sub>4</sub>"



Elevatori, Weisheitszahnhaken  
 Elevators, Third molar hook  
 Elevadores, Ganchito retractor de la muela del juicio  
 Elevateur, Crochet à dent de sagesse  
 Elevatori, Uncino per dente del giudizio



**HENAHAN**  
 20,0 cm/8"



Fig. 1-1  
 KA 897/01



Fig. 1-2  
 KA 897/02



Fig. 1-3  
 KA 897/03



AA  
 AB  
 AC  
 AD  
 AE  
 AF  
 AK  
 AL  
 AM  
 AO  
 AP  
 AR  
**KA**  
 KD  
 KU  
 KY

Bleihände, Fingerringsägen und Nagelzange  
 Lead Hands, Finger Ring Saws and Nail Instrument  
 Manoplas de plomo, sierras para abrir anillos y pinza para uñas  
 Manches en plomb, scies pour bagues et pince à ongle  
 Mani di piombo, seghe per anelli e pinza per unghie

**KA 900/01**  
 für Kinder  
 Child Size  
 Para niños  
 Pour enfants  
 Per bambini



**KA 900/02**  
 für Erwachsene  
 Adult Size  
 Para adultos  
 Pour adultes  
 Per adulti



**KA 908/17**  
 17,0 cm/6<sup>3</sup>/<sub>4</sub>"



**WALTON**  
**KA 910/17**  
 16,0 cm/6<sup>1</sup>/<sub>4</sub>"

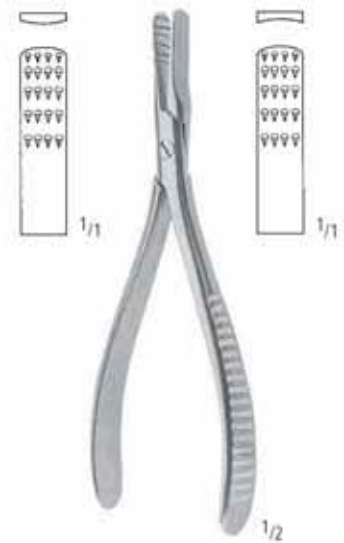

**RADOLF**  
**KA 918/13**  
 13,5 cm/5<sup>1</sup>/<sub>4</sub>"

Autopsie-Säge  
Post Mortem Saw  
Sierra para autopsia  
Scie à autopsie  
Sega per autopsia

# OSCI nopa<sup>®</sup>

**Autoklavierbar  
Autoclavable  
Autoclavable  
Autoclavable  
Autoclavabile**



KA 995/00 = 230 V  
(+ KA 996/50 + KA 996/65 + KA 997/01 + KA 998/23 + KA 999/16)  
Euro-Flachstecker / EU-plug

KA 995/01 = 110 V  
(+ KA 996/50 + KA 996/65 + KA 997/01 + KA 998/23 + KA 999/16)  
USA-Stecker / USA-plug



KA 996/50 = Ø 50 mm  
KA 996/65 = Ø 65 mm



KA 997/01



KA 998/23



KA 999/16  
16,0 cm/6<sup>1</sup>/<sub>4</sub>"

AA  
AB  
AC  
AD  
AE  
AF  
AK  
AL  
AM  
AO  
AP  
AR  
KA  
KD  
KU  
KY

Autopsie-Säge  
 Post Mortem Saw  
 Sierra para autopsia  
 Scie à autopsie  
 Sega per autopsia

nopa® P R O F I



KA 995/10 = 230 V  
 (+ KA 996/50 + KA 996/65 + KA 997/01 + KA 997/39 + KA 998/24 + KA 999/16)  
 Euro-Flachstecker / EU-plug  
 KA 995/11 = 110 V  
 (+ KA 996/50 + KA 996/65 + KA 997/01 + KA 997/39 + KA 998/24 + KA 999/16)  
 USA-Stecker / USA-plug



KA 996/50 = Ø 50 mm  
 KA 996/65 = Ø 65 mm



KA 997/01



KA 997/39



KA 998/24



KA 999/16  
 16,0 cm/6<sup>1</sup>/<sub>4</sub>"

Autopsie-Säge  
 Post Mortem Saw  
 Sierra para autopsia  
 Scie à autopsie  
 Sega per autopsia



1/2

KA 996/50 = Ø 50 mm  
 KA 996/65 = Ø 65 mm



1/2

KA 997/01



1/2

KA 997/02 = 8 mm  
 KA 997/03 = 20 mm



1/2

KA 997/04



1/2

KA 997/05

nur für nopa PROF I  
 only for nopa PROF I



KA 997/11



KA 997/39



KA 997/58

AA  
 AB  
 AC  
 AD  
 AE  
 AF  
 AK  
 AL  
 AM  
 AN  
 AO  
 AP  
 AR  
 KA  
 KD  
 KE  
 KF  
 KG  
 KH  
 KI  
 KJ  
 KK  
 KL  
 KM  
 KN  
 KO  
 KP  
 KQ  
 KR  
 KS  
 KT  
 KU  
 KV  
 KW  
 KY



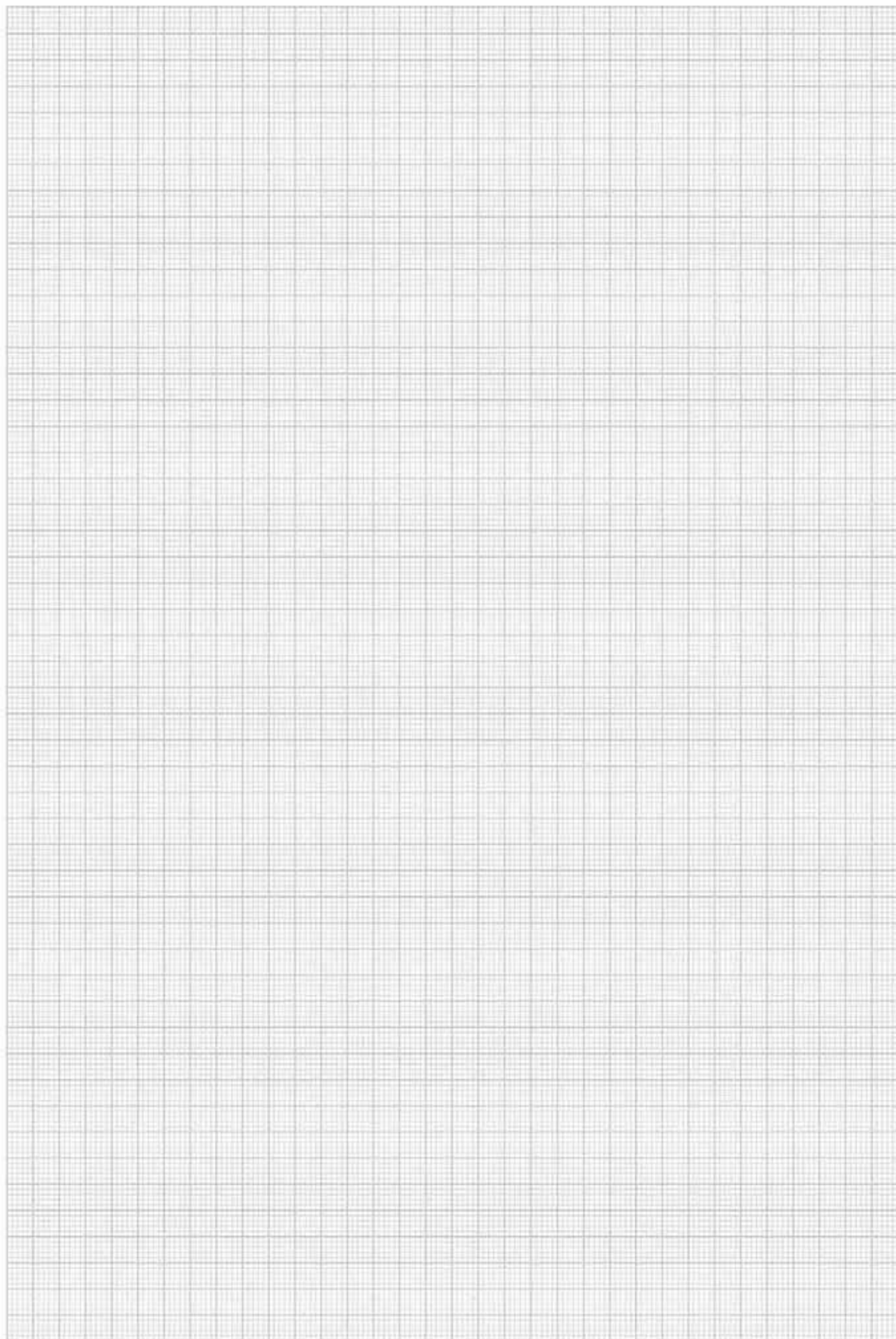



Repositionszangen  
 Reposition forceps  
 Pinzas de reposicion  
 Pincas de reposition  
 Pinze per riposizione



**ROWE**  
 KA 2970/23  
 23,0 cm/9"



**ROWE**  
 KA 2971/23  
 23,0 cm/9"

AA  
 AB  
 AC  
 AD  
 AE  
 AF  
 AK  
 AL  
 AM  
 AO  
 AP  
 AR  
 KA  
 KD  
 KU  
 KY

KA

Instrumentarium für Küntscher - Nägel  
 Instruments for Küntscher Nails  
 Instrumentos para clavos Küntscher  
 Instrumentation pour les clous de Küntscher  
 Strumenti per chiodi Küntscher



**KÜNTSCHER**  
KA 4900/01



**KÜNTSCHER**  
KA 4900/02



**KÜNTSCHER**  
KA 4900/03



KA 4901/00



29,0 cm/11 <sup>1</sup> / <sub>2</sub> "	KA 4902/29
37,0 cm/14 <sup>1</sup> / <sub>2</sub> "	KA 4902/37
42,0 cm/16 <sup>1</sup> / <sub>2</sub> "	KA 4902/42
49,0 cm/19 <sup>1</sup> / <sub>4</sub> "	KA 4902/49

Instrumentarium für Küntscher - Nägel  
 Instruments for Küntscher Nails  
 Instrumentos para clavos Küntscher  
 Instrumentation pour les clous de Küntscher  
 Strumenti per chiodi Küntscher

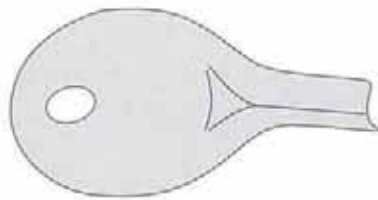

KA 4913/00



KÜNTSCHER  
KA 4913/26



KÜNTSCHER  
KA 4913/35



Führungsspieß - Guide Pin - Tallo guida - Guide broche - Spiedo da guida

cm	inch	Ø 3,0 mm	Ø 3,5 mm	Ø 4,0 mm	Ø 5,0 mm
35,0	14	KA 4915/35	KA 4916/35	KA 4917/35	KA 4918/35
46,0	18	KA 4915/46	KA 4916/46	KA 4917/46	KA 4918/46
60,0	23 1/2		KA 4916/60	KA 4917/60	KA 4918/60
		für Nägel bis for nails up to para clavos hasta pour clous jusqu'à per chiodi fino a Ø 8,0 mm	für Nägel for nails para clavos pour clous per chiodi Ø 9,0 mm Ø 10,0 mm Ø 11,0 mm		für Nägel ab for nails from para clavos desde pour clous à partir de per chiodi a partire da Ø 11,0 mm

AA  
AB  
AC  
AD  
AE  
AF  
AK  
AL  
AM  
AO  
AP  
AR  
KA  
KD  
KU  
KY

Zubehör für Haken-Marknägel  
 Accessories for Intramedullary Pins with Hooks  
 Accesorios para clavos intramedulares con ganchos  
 Accessoires pour broches centro-médullaires  
 Accessori per chiodi centromidollari con gancio



KA 4919/20

Ø 2,5 mm KA 4920/02  
 Ø 3,0 mm KA 4920/03  
 Ø 5,0 mm KA 4920/05  
 Ø 6,0 mm KA 4920/06

Ø 2,5 mm  
 KA 4922/02

Ø 3,0 mm  
 KA 4922/03

Ø 5,0 mm  
 KA 4922/05

Ø 6,0 mm  
 KA 4922/06

Schraubenzieher  
Screw Drivers  
Destornilladores  
Tournevis  
Giravite

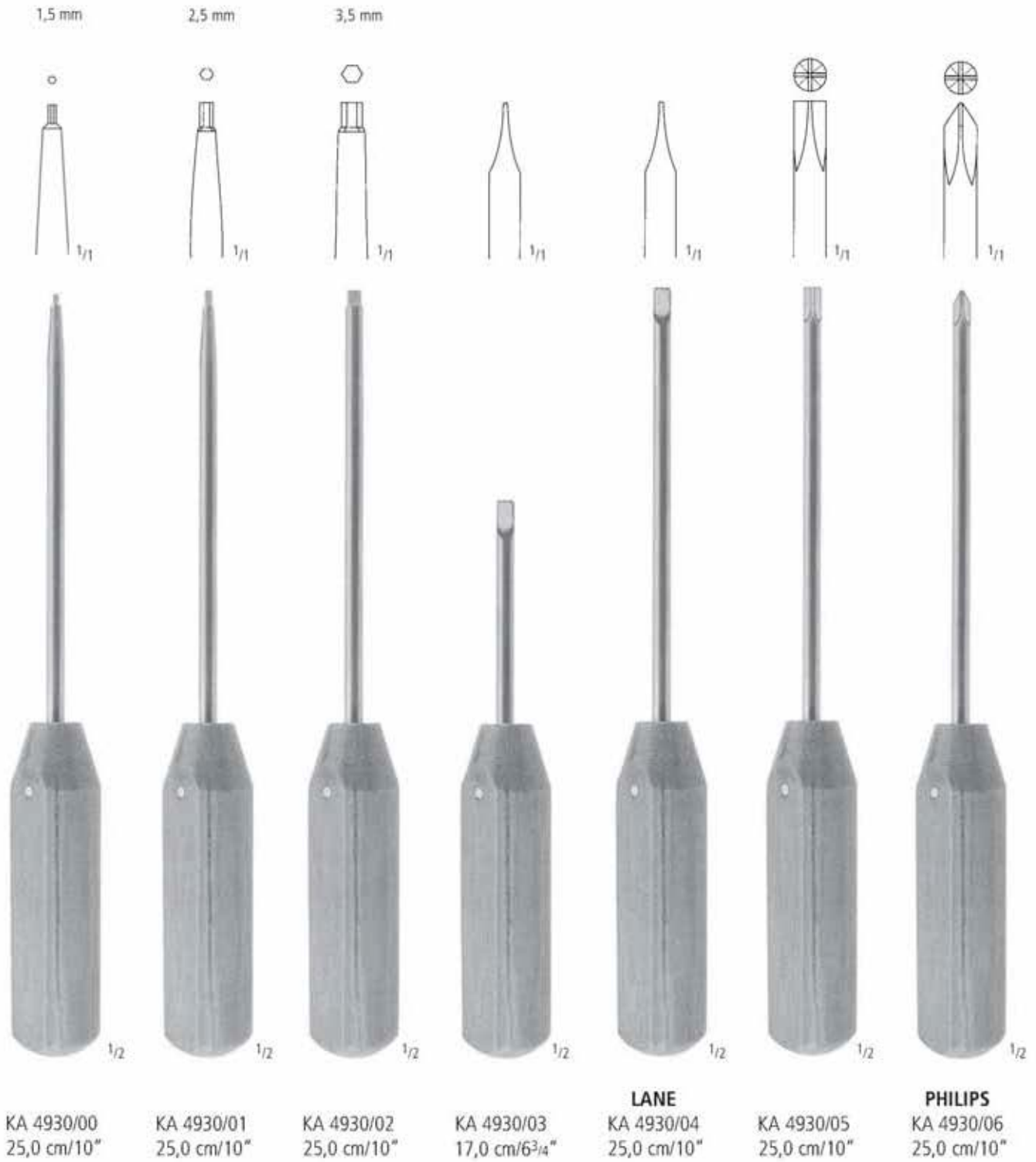

AA  
AB  
AC  
AD  
AE  
AF  
AK  
AL  
AM  
AO  
AP  
AR  
**KA**  
KD  
KU  
KY

Küntscher Nägel, Oberschenkel  
 Küntscher Intramedullary Nails, Femur  
 Küntscher clavos intramedulares, fémur  
 Clous centromédullaires selon Küntscher pour le fémur  
 Chiodi centromidollari secondo Küntscher per femore



KÜNTSCHER

Single Slot

cm	"	6 mm	7 mm	8 mm	9 mm	10 mm	11 mm	12 mm
14,0	5 <sup>1</sup> / <sub>2</sub>	KA 5006/14	KA 5007/14					
16,0	6 <sup>1</sup> / <sub>4</sub>	KA 5006/16	KA 5007/16					
18,0	7	KA 5006/18	KA 5007/18					
20,0	8	KA 5006/20	KA 5007/20					
22,0	8 <sup>3</sup> / <sub>4</sub>	KA 5006/22	KA 5007/22					
24,0	9 <sup>1</sup> / <sub>2</sub>	KA 5006/24	KA 5007/24	KA 5008/24				
26,0	10 <sup>1</sup> / <sub>2</sub>	KA 5006/26	KA 5007/26	KA 5008/26				
28,0	11	KA 5006/28	KA 5007/28	KA 5008/28				
30,0	12	KA 5006/30	KA 5007/30	KA 5008/30	KA 5009/30			
32,0	12 <sup>3</sup> / <sub>4</sub>	KA 5006/32	KA 5007/32	KA 5008/32	KA 5009/32	KA 5010/32	KA 5011/32	
34,0	13 <sup>1</sup> / <sub>3</sub>	KA 5006/34	KA 5007/34	KA 5008/34	KA 5009/34	KA 5010/34	KA 5011/34	KA 5012/34
36,0	14	KA 5006/36	KA 5007/36	KA 5008/36	KA 5009/36	KA 5010/36	KA 5011/36	KA 5012/36
38,0	15 <sup>1</sup> / <sub>4</sub>		KA 5007/38	KA 5008/38	KA 5009/38	KA 5010/38	KA 5011/38	KA 5012/38
40,0	15 <sup>3</sup> / <sub>4</sub>		KA 5007/40	KA 5008/40	KA 5009/40	KA 5010/40	KA 5011/40	KA 5012/40
42,0	16 <sup>1</sup> / <sub>2</sub>			KA 5008/42	KA 5009/42	KA 5010/42	KA 5011/42	KA 5012/42
44,0	17 <sup>1</sup> / <sub>3</sub>			KA 5008/44	KA 5009/44	KA 5010/44	KA 5011/44	KA 5012/44
46,0	18			KA 5008/46	KA 5009/46	KA 5010/46	KA 5011/46	KA 5012/46
48,0	19			KA 5008/48	KA 5009/48	KA 5010/48	KA 5011/48	KA 5012/48
50,0	19 <sup>3</sup> / <sub>4</sub>			KA 5008/50	KA 5009/50	KA 5010/50	KA 5011/50	KA 5012/50
52,0	20 <sup>1</sup> / <sub>2</sub>				KA 5009/52	KA 5010/52	KA 5011/52	KA 5012/52

cm	"	13 mm	14 mm	15 mm	16 mm	17 mm	18 mm
14,0	5 <sup>1</sup> / <sub>2</sub>						
16,0	6 <sup>1</sup> / <sub>4</sub>						
18,0	7						
20,0	8						
22,0	8 <sup>3</sup> / <sub>4</sub>						
24,0	9 <sup>1</sup> / <sub>2</sub>						
26,0	10 <sup>1</sup> / <sub>2</sub>						
28,0	11						
30,0	12						
32,0	12 <sup>3</sup> / <sub>4</sub>						
34,0	13 <sup>1</sup> / <sub>3</sub>	KA 5013/34	KA 5014/34				
36,0	14	KA 5013/36	KA 5014/36	KA 5015/36	KA 5016/36	KA 5017/36	KA 5018/36
38,0	15 <sup>1</sup> / <sub>4</sub>	KA 5013/38	KA 5014/38	KA 5015/38	KA 5016/38	KA 5017/38	KA 5018/38
40,0	15 <sup>3</sup> / <sub>4</sub>	KA 5013/40	KA 5014/40	KA 5015/40	KA 5016/40	KA 5017/40	KA 5018/40
42,0	16 <sup>1</sup> / <sub>2</sub>	KA 5013/42	KA 5014/42	KA 5015/42	KA 5016/42	KA 5017/42	KA 5018/42
44,0	17 <sup>1</sup> / <sub>3</sub>	KA 5013/44	KA 5014/44	KA 5015/44	KA 5016/44	KA 5017/44	KA 5018/44
46,0	18	KA 5013/46	KA 5014/46	KA 5015/46	KA 5016/46	KA 5017/46	KA 5018/46
48,0	19	KA 5013/48	KA 5014/48	KA 5015/48	KA 5016/48	KA 5017/48	KA 5018/48
50,0	19 <sup>3</sup> / <sub>4</sub>	KA 5013/50	KA 5014/50	KA 5015/50	KA 5016/50	KA 5017/50	KA 5018/50
52,0	20 <sup>1</sup> / <sub>2</sub>	KA 5013/52	KA 5014/52	KA 5015/52	KA 5016/52	KA 5017/52	KA 5018/52



ORTHOPÄDIE ORTHOPAEDIC ORTOPEDIA ORTHOPEDIE ORTOPEDIA

Küntscher Nägel, Oberschenkel  
 Küntscher Intramedullary Nails, Femur  
 Küntscher clavos intramedulares, fémur  
 Clous centromédullaires selon Küntscher pour le fémur  
 Chiodi centromidollari secondo Küntscher per femore



KÜNTSCHER

Double Slot

cm	"	6 mm	7 mm	8 mm	9 mm	10 mm	11 mm	12 mm
14,0	5 <sup>1</sup> / <sub>2</sub>	KA 5026/14	KA 5027/14					
16,0	6 <sup>1</sup> / <sub>4</sub>	KA 5026/16	KA 5027/16					
18,0	7	KA 5026/18	KA 5027/18					
20,0	8	KA 5026/20	KA 5027/20					
22,0	8 <sup>3</sup> / <sub>4</sub>	KA 5026/22	KA 5027/22					
24,0	9 <sup>1</sup> / <sub>2</sub>	KA 5026/24	KA 5027/24	KA 5028/24				
26,0	10 <sup>1</sup> / <sub>2</sub>	KA 5026/26	KA 5027/26	KA 5028/26				
28,0	11	KA 5026/28	KA 5027/28	KA 5028/28				
30,0	12	KA 5026/30	KA 5027/30	KA 5028/30	KA 5029/30			
32,0	12 <sup>3</sup> / <sub>4</sub>	KA 5026/32	KA 5027/32	KA 5028/32	KA 5029/32	KA 5030/32	KA 5031/32	
34,0	13 <sup>1</sup> / <sub>3</sub>	KA 5026/34	KA 5027/34	KA 5028/34	KA 5029/34	KA 5030/34	KA 5031/34	KA 5032/34
36,0	14	KA 5026/36	KA 5027/36	KA 5028/36	KA 5029/36	KA 5030/36	KA 5031/36	KA 5032/36
38,0	15 <sup>1</sup> / <sub>4</sub>		KA 5027/38	KA 5028/38	KA 5029/38	KA 5030/38	KA 5031/38	KA 5032/38
40,0	15 <sup>3</sup> / <sub>4</sub>		KA 5027/40	KA 5028/40	KA 5029/40	KA 5030/40	KA 5031/40	KA 5032/40
42,0	16 <sup>1</sup> / <sub>2</sub>			KA 5028/42	KA 5029/42	KA 5030/42	KA 5031/42	KA 5032/42
44,0	17 <sup>1</sup> / <sub>3</sub>			KA 5028/44	KA 5029/44	KA 5030/44	KA 5031/44	KA 5032/44
46,0	18			KA 5028/46	KA 5029/46	KA 5030/46	KA 5031/46	KA 5032/46
48,0	19			KA 5028/48	KA 5029/48	KA 5030/48	KA 5031/48	KA 5032/48
50,0	19 <sup>3</sup> / <sub>4</sub>			KA 5028/50	KA 5029/50	KA 5030/50	KA 5031/50	KA 5032/50
52,0	20 <sup>1</sup> / <sub>2</sub>				KA 5029/52	KA 5030/52	KA 5031/52	KA 5032/52

cm	"	13 mm	14 mm	15 mm	16 mm	17 mm	18 mm
14,0	5 <sup>1</sup> / <sub>2</sub>						
16,0	6 <sup>1</sup> / <sub>4</sub>						
18,0	7						
20,0	8						
22,0	8 <sup>3</sup> / <sub>4</sub>						
24,0	9 <sup>1</sup> / <sub>2</sub>						
26,0	10 <sup>1</sup> / <sub>2</sub>						
28,0	11						
30,0	12						
32,0	12 <sup>3</sup> / <sub>4</sub>						
34,0	13 <sup>1</sup> / <sub>3</sub>	KA 5033/34	KA 5034/34				
36,0	14	KA 5033/36	KA 5034/36	KA 5035/36	KA 5036/36	KA 5037/36	KA 5038/36
38,0	15 <sup>1</sup> / <sub>4</sub>	KA 5033/38	KA 5034/38	KA 5035/38	KA 5036/38	KA 5037/38	KA 5038/38
40,0	15 <sup>3</sup> / <sub>4</sub>	KA 5033/40	KA 5034/40	KA 5035/40	KA 5036/40	KA 5037/40	KA 5038/40
42,0	16 <sup>1</sup> / <sub>2</sub>	KA 5033/42	KA 5034/42	KA 5035/42	KA 5036/42	KA 5037/42	KA 5038/42
44,0	17 <sup>1</sup> / <sub>3</sub>	KA 5033/44	KA 5034/44	KA 5035/44	KA 5036/44	KA 5037/44	KA 5038/44
46,0	18	KA 5033/46	KA 5034/46	KA 5035/46	KA 5036/46	KA 5037/46	KA 5038/46
48,0	19	KA 5033/48	KA 5034/48	KA 5035/48	KA 5036/48	KA 5037/48	KA 5038/48
50,0	19 <sup>3</sup> / <sub>4</sub>	KA 5033/50	KA 5034/50	KA 5035/50	KA 5036/50	KA 5037/50	KA 5038/50
52,0	20 <sup>1</sup> / <sub>2</sub>	KA 5033/52	KA 5034/52	KA 5035/52	KA 5036/52	KA 5037/52	KA 5038/52

AA  
AB  
AC  
AD  
AE  
AF  
AK  
AL  
AM  
AO  
AP  
AR  
KA  
KD  
KU  
KY

Küntscher Nägel für Unterschenkel und Oberarm  
 Küntscher Intramedullary Nails, tibia and humerus  
 Küntscher clavos intramedulares, tibia y húmero  
 Clous centromédullaires selon Küntscher pour le tibia et l'humerus  
 Chiodi centromidollari secondo Küntscher per tibia e omero



KÜNTSCHER

cm	"	6 mm	7 mm	8 mm	9 mm	10 mm	11 mm	12 mm	13 mm	14 mm
18,0	7	KA 5046/18	KA 5047/18	KA 5048/18	KA 5049/18	KA 5050/18	KA 5051/18	KA 5052/18	KA 5053/18	
19,0	7½	KA 5046/19	KA 5047/19	KA 5048/19	KA 5049/19	KA 5050/19	KA 5051/19	KA 5052/19	KA 5053/19	
20,0	8	KA 5046/20	KA 5047/20	KA 5048/20	KA 5049/20	KA 5050/20	KA 5051/20	KA 5052/20	KA 5053/20	
21,0	8¼	KA 5046/21	KA 5047/21	KA 5048/21	KA 5049/21	KA 5050/21	KA 5051/21	KA 5052/21	KA 5053/21	
22,0	8¾	KA 5046/22	KA 5047/22	KA 5048/22	KA 5049/22	KA 5050/22	KA 5051/22	KA 5052/22	KA 5053/22	
23,0	9	KA 5046/23	KA 5047/23	KA 5048/23	KA 5049/23	KA 5050/23	KA 5051/23	KA 5052/23	KA 5053/23	
24,0	9½	KA 5046/24	KA 5047/24	KA 5048/24	KA 5049/24	KA 5050/24	KA 5051/24	KA 5052/24	KA 5053/24	
25,0	10	KA 5046/25	KA 5047/25	KA 5048/25	KA 5049/25	KA 5050/25	KA 5051/25	KA 5052/25	KA 5053/25	
26,0	10½	KA 5046/26	KA 5047/26	KA 5048/26	KA 5049/26	KA 5050/26	KA 5051/26	KA 5052/26	KA 5053/26	
27,0	10¾	KA 5046/27	KA 5047/27	KA 5048/27	KA 5049/27	KA 5050/27	KA 5051/27	KA 5052/27	KA 5053/27	
28,0	11	KA 5046/28	KA 5047/28	KA 5048/28	KA 5049/28	KA 5050/28	KA 5051/28	KA 5052/28	KA 5053/28	
29,0	11½	KA 5046/29	KA 5047/29	KA 5048/29	KA 5049/29	KA 5050/29	KA 5051/29	KA 5052/29	KA 5053/29	
30,0	12	KA 5046/30	KA 5047/30	KA 5048/30	KA 5049/30	KA 5050/30	KA 5051/30	KA 5052/30	KA 5053/30	KA 5054/30
31,0	12¼		KA 5047/31	KA 5048/31	KA 5049/31	KA 5050/31	KA 5051/31	KA 5052/31	KA 5053/31	KA 5054/31
32,0	12¾		KA 5047/32	KA 5048/32	KA 5049/32	KA 5050/32	KA 5051/32	KA 5052/32	KA 5053/32	KA 5054/32
33,0	13		KA 5047/33	KA 5048/33	KA 5049/33	KA 5050/33	KA 5051/33	KA 5052/33	KA 5053/33	KA 5054/33
34,0	13⅓		KA 5047/34	KA 5048/34	KA 5049/34	KA 5050/34	KA 5051/34	KA 5052/34	KA 5053/34	KA 5054/34
35,0	13¾		KA 5047/35	KA 5048/35	KA 5049/35	KA 5050/35	KA 5051/35	KA 5052/35	KA 5053/35	KA 5054/35
36,0	14		KA 5047/36	KA 5048/36	KA 5049/36	KA 5050/36	KA 5051/36	KA 5052/36	KA 5053/36	KA 5054/36
37,0	14½		KA 5047/37	KA 5048/37	KA 5049/37	KA 5050/37	KA 5051/37	KA 5052/37	KA 5053/37	KA 5054/37
38,0	15¼		KA 5047/38	KA 5048/38	KA 5049/38	KA 5050/38	KA 5051/38	KA 5052/38	KA 5053/38	KA 5054/38
39,0	15⅓		KA 5047/39	KA 5048/39	KA 5049/39	KA 5050/39	KA 5051/39	KA 5052/39	KA 5053/39	KA 5054/39
40,0	15¾		KA 5047/40	KA 5048/40	KA 5049/40	KA 5050/40	KA 5051/40	KA 5052/40	KA 5053/40	KA 5054/40

ORTHOPÄDIE ORTHOPAEDIC ORTOPEDIA ORTHOPEDIE ORTOPEDIA

Marknägel, rund, mit Haken  
 Intramedullary Pins, round, with hook  
 Clavos intramedulares, redondos, con gancho  
 Broches à crochet pour enclouage centro-médullaire, rondes  
 Chiodi a gancio per inchiodamento centromidollare, rotondi

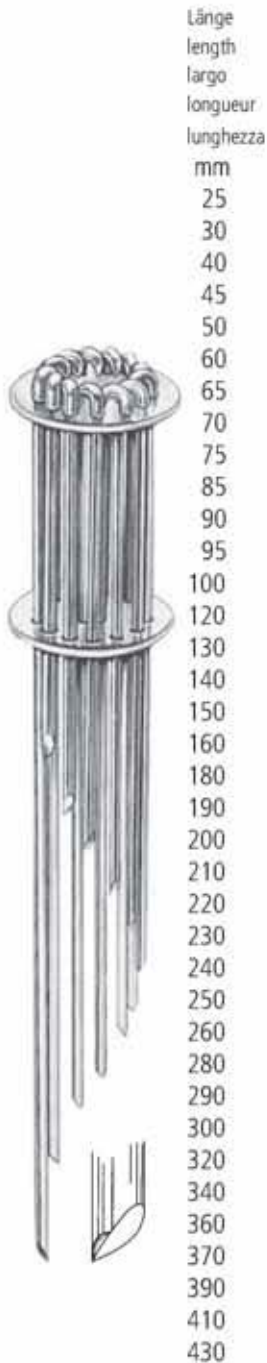

Länge	
length	
largo	
longueur	KA 5080/00
lunghezza	Ø 2,5 mm
mm	
25	KA 5080/25
30	KA 5080/30
40	KA 5080/40
45	KA 5080/45
50	KA 5080/50
60	KA 5080/60
65	KA 5080/65
70	KA 5080/70
75	KA 5080/75
85	KA 5080/85
90	KA 5080/90
95	KA 5080/95
100	KA 5080/99
120	
130	
140	
150	
160	
180	
190	
200	
210	
220	
230	
240	
250	
260	
280	
290	
300	
320	
340	
360	
370	
390	
410	
430	

Satz - set - juego - jeu - serie

KA 5081/00	KA 5082/00	KA 5083/00
Ø 3,0 mm	Ø 5,0 mm	Ø 5,0 mm
KA 5081/10		
KA 5081/12		
KA 5081/13		
KA 5081/14		
KA 5081/15		
KA 5081/16		
KA 5081/18		
KA 5081/19		
KA 5081/20	KA 5082/20	
KA 5081/21		
	KA 5082/22	
KA 5081/23		
KA 5081/24	KA 5082/24	
KA 5081/25		
	KA 5082/26	
	KA 5082/28	KA 5083/28
		KA 5083/29
	KA 5082/30	
	KA 5082/32	KA 5083/32
	KA 5082/34	KA 5083/34
	KA 5082/36	KA 5083/36
		KA 5083/37
		KA 5083/39
		KA 5083/41
		KA 5083/43

**KA 5080/00**  
**KA 5080/25 - KA 5080/99**

für Finger und Fuß

for small bones  
 para huesos pequeños  
 pour les petits os  
 per le ossa piccole

**KA 5081/00**  
**KA 5081/10 - KA 5081/25**

für Unterarm und Clavicula

for radius, ulna and clavica  
 para radio, ulna y clavícula  
 pour radius, cubitus et clavicule  
 per radio, ulna e clavicola

**KA 5082/00**  
**KA 5082/20 - KA 5082/36**

für Unterschenkel und Oberarm

for tibia and humeros  
 para tibia y humero  
 pour tibia et humérus  
 per tibia e omero

**KA 5083/00**  
**KA 5083/28 - KA 5083/43**

für Ober- und Unterschenkel

for femur and tibia  
 para fémur y tibia  
 pour fémur et tibia  
 per femore e tibia

AA  
AB  
AC  
AD  
AE  
AF  
AK  
AL  
AM  
AO  
AP  
AR  
KA  
KD  
KU  
KY



Nägel, Klammern  
Fracture Pins, Clips  
Clavos para huesos, Grapas  
Clous à os, agrafes  
Chiodi per ossa, grappas

**WILDBERG**



KA 5087/16



KA 5087/19



KA 5087/22



**PALMER**  
Ø 1,5 mm

KA 5090/15	15 mm
KA 5090/20	20 mm
KA 5090/25	25 mm
KA 5090/35	35 mm
KA 5090/40	40 mm
KA 5090/45	45 mm
KA 5090/50	50 mm
KA 5090/55	55 mm
KA 5090/60	60 mm
KA 5090/65	65 mm
KA 5090/70	70 mm

ORTHOPÄDIE ORTHOPAEDIC ORTOPEDIA ORTHOPEDIE ORTOPEDIA

Steinmann Nägel  
Steinmann Pins  
Clavos Steinmann  
Clous Steinmann  
Aghi Steinmann

AA  
AB  
AC  
AD  
AE  
AF  
AK  
AL  
AM  
AO  
AP  
AR  
KA  
KD  
KU  
KY



STEINMANN

	3,2 mm	3,5 mm	4,0 mm	4,2 mm	4,5 mm	4,8 mm	5,0 mm	5,5 mm	6,0 mm
10,0 cm	KA 5301/10	KA 5302/10	KA 5303/10	KA 5304/10	KA 5305/10	KA 5306/10	KA 5307/10	KA 5308/10	KA 5309/10
15,0 cm	KA 5301/15	KA 5302/15	KA 5303/15	KA 5304/15	KA 5305/15	KA 5306/15	KA 5307/15	KA 5308/15	KA 5309/15
18,0 cm	KA 5301/18	KA 5302/18	KA 5303/18	KA 5304/18	KA 5305/18	KA 5306/18	KA 5307/18	KA 5308/18	KA 5309/18
20,0 cm	KA 5301/20	KA 5302/20	KA 5303/20	KA 5304/20	KA 5305/20	KA 5306/20	KA 5307/20	KA 5308/20	KA 5309/20
22,0 cm	KA 5301/22	KA 5302/22	KA 5303/22	KA 5304/22	KA 5305/22	KA 5306/22	KA 5307/22	KA 5308/22	KA 5309/22
23,5 cm	KA 5301/23	KA 5302/23	KA 5303/23	KA 5304/23	KA 5305/23	KA 5306/23	KA 5307/23	KA 5308/23	KA 5309/23
25,0 cm	KA 5301/25	KA 5302/25	KA 5303/25	KA 5304/25	KA 5305/25	KA 5306/25	KA 5307/25	KA 5308/25	KA 5309/25
28,0 cm	KA 5301/28	KA 5302/28	KA 5303/28	KA 5304/28	KA 5305/28	KA 5306/28	KA 5307/28	KA 5308/28	KA 5309/28
30,0 cm	KA 5301/30	KA 5302/30	KA 5303/30	KA 5304/30	KA 5305/30	KA 5306/30	KA 5307/30	KA 5308/30	KA 5309/30



STEINMANN

	3,2 mm	3,5 mm	4,0 mm	4,2 mm	4,5 mm	4,8 mm	5,0 mm	5,5 mm	6,0 mm
10,0 cm	KA 5311/10	KA 5312/10	KA 5313/10	KA 5314/10	KA 5315/10	KA 5316/10	KA 5317/10	KA 5318/10	KA 5319/10
15,0 cm	KA 5311/15	KA 5312/15	KA 5313/15	KA 5314/15	KA 5315/15	KA 5316/15	KA 5317/15	KA 5318/15	KA 5319/15
18,0 cm	KA 5311/18	KA 5312/18	KA 5313/18	KA 5314/18	KA 5315/18	KA 5316/18	KA 5317/18	KA 5318/18	KA 5319/18
20,0 cm	KA 5311/20	KA 5312/20	KA 5313/20	KA 5314/20	KA 5315/20	KA 5316/20	KA 5317/20	KA 5318/20	KA 5319/20
22,0 cm	KA 5311/22	KA 5312/22	KA 5313/22	KA 5314/22	KA 5315/22	KA 5316/22	KA 5317/22	KA 5318/22	KA 5319/22
23,5 cm	KA 5311/23	KA 5312/23	KA 5313/23	KA 5314/23	KA 5315/23	KA 5316/23	KA 5317/23	KA 5318/23	KA 5319/23
25,0 cm	KA 5311/25	KA 5312/25	KA 5313/25	KA 5314/25	KA 5315/25	KA 5316/25	KA 5317/25	KA 5318/25	KA 5319/25
28,0 cm	KA 5311/28	KA 5312/28	KA 5313/28	KA 5314/28	KA 5315/28	KA 5316/28	KA 5317/28	KA 5318/28	KA 5319/28
30,0 cm	KA 5311/30	KA 5312/30	KA 5313/30	KA 5314/30	KA 5315/30	KA 5316/30	KA 5317/30	KA 5318/30	KA 5319/30

KA

**KA** ORTHOPÄDIE ORTHOPAEDIC ORTOPEDIA ORTHOPEDIE ORTOPEDIA

Steinmann Nägel  
 Steinmann Pins  
 Clavos Steinmann  
 Clous Steinmann  
 Aghi Steinmann



**STEINMANN**

	3,2 mm	3,5 mm	4,0 mm	4,2 mm	4,5 mm	4,8 mm	5,0 mm	5,5 mm	6,0 mm
10,0 cm	KA 5321/10	KA 5322/10	KA 5323/10	KA 5324/10	KA 5325/10	KA 5326/10	KA 5327/10	KA 5328/10	KA 5329/10
15,0 cm	KA 5321/15	KA 5322/15	KA 5323/15	KA 5324/15	KA 5325/15	KA 5326/15	KA 5327/15	KA 5328/15	KA 5329/15
18,0 cm	KA 5321/18	KA 5322/18	KA 5323/18	KA 5324/18	KA 5325/18	KA 5326/18	KA 5327/18	KA 5328/18	KA 5329/18
20,0 cm	KA 5321/20	KA 5322/20	KA 5323/20	KA 5324/20	KA 5325/20	KA 5326/20	KA 5327/20	KA 5328/20	KA 5329/20
22,0 cm	KA 5321/22	KA 5322/22	KA 5323/22	KA 5324/22	KA 5325/22	KA 5326/22	KA 5327/22	KA 5328/22	KA 5329/22
23,5 cm	KA 5321/23	KA 5322/23	KA 5323/23	KA 5324/23	KA 5325/23	KA 5326/23	KA 5327/23	KA 5328/23	KA 5329/23
25,0 cm	KA 5321/25	KA 5322/25	KA 5323/25	KA 5324/25	KA 5325/25	KA 5326/25	KA 5327/25	KA 5328/25	KA 5329/25
28,0 cm	KA 5321/28	KA 5322/28	KA 5323/28	KA 5324/28	KA 5325/28	KA 5326/28	KA 5327/28	KA 5328/28	KA 5329/28
30,0 cm	KA 5321/30	KA 5322/30	KA 5323/30	KA 5324/30	KA 5325/30	KA 5326/30	KA 5327/30	KA 5328/30	KA 5329/30



**STEINMANN**

	3,2 mm	3,5 mm	4,0 mm	4,2 mm	4,5 mm	4,8 mm	5,0 mm	5,5 mm	6,0 mm
10,0 cm	KA 5331/10	KA 5332/10	KA 5333/10	KA 5334/10	KA 5335/10	KA 5336/10	KA 5337/10	KA 5338/10	KA 5339/10
15,0 cm	KA 5331/15	KA 5332/15	KA 5333/15	KA 5334/15	KA 5335/15	KA 5336/15	KA 5337/15	KA 5338/15	KA 5339/15
18,0 cm	KA 5331/18	KA 5332/18	KA 5333/18	KA 5334/18	KA 5335/18	KA 5336/18	KA 5337/18	KA 5338/18	KA 5339/18
20,0 cm	KA 5331/20	KA 5332/20	KA 5333/20	KA 5334/20	KA 5335/20	KA 5336/20	KA 5337/20	KA 5338/20	KA 5339/20
22,0 cm	KA 5331/22	KA 5332/22	KA 5333/22	KA 5334/22	KA 5335/22	KA 5336/22	KA 5337/22	KA 5338/22	KA 5339/22
23,5 cm	KA 5331/23	KA 5332/23	KA 5333/23	KA 5334/23	KA 5335/23	KA 5336/23	KA 5337/23	KA 5338/23	KA 5339/23
25,0 cm	KA 5331/25	KA 5332/25	KA 5333/25	KA 5334/25	KA 5335/25	KA 5336/25	KA 5337/25	KA 5338/25	KA 5339/25
28,0 cm	KA 5331/28	KA 5332/28	KA 5333/28	KA 5334/28	KA 5335/28	KA 5336/28	KA 5337/28	KA 5338/28	KA 5339/28
30,0 cm	KA 5331/30	KA 5332/30	KA 5333/30	KA 5334/30	KA 5335/30	KA 5336/30	KA 5337/30	KA 5338/30	KA 5339/30



ORTHOPÄDIE ORTHOPAEDIC ORTOPEDIA ORTHOPEDIE ORTOPEDIA

Kirschner Bohrdrähte  
Kirschner Wires  
Agujas Kirschner  
Broches de Kirschner  
Fili Kirschner

AA  
AB  
AC  
AD  
AE  
AF  
AK  
AL  
AM  
AO  
AP  
AR  
KA  
KD  
KY



KIRSCHNER

	60 mm	70 mm	80 mm	120 mm	140 mm	160 mm	230 mm	310 mm
0,6 mm	KA 5401/06	KA 5402/06	KA 5403/06	KA 5404/06	KA 5405/06	KA 5406/06	KA 5407/06	KA 5408/06
0,8 mm	KA 5401/08	KA 5402/08	KA 5403/08	KA 5404/08	KA 5405/08	KA 5406/08	KA 5407/08	KA 5408/08
0,9 mm	KA 5401/09	KA 5402/09	KA 5403/09	KA 5404/09	KA 5405/09	KA 5406/09	KA 5407/09	KA 5408/09
1,0 mm	KA 5401/10	KA 5402/10	KA 5403/10	KA 5404/10	KA 5405/10	KA 5406/10	KA 5407/10	KA 5408/10
1,2 mm	KA 5401/12	KA 5402/12	KA 5403/12	KA 5404/12	KA 5405/12	KA 5406/12	KA 5407/12	KA 5408/12
1,4 mm	KA 5401/14	KA 5402/14	KA 5403/14	KA 5404/14	KA 5405/14	KA 5406/14	KA 5407/14	KA 5408/14
1,5 mm	KA 5401/15	KA 5402/15	KA 5403/15	KA 5404/15	KA 5405/15	KA 5406/15	KA 5407/15	KA 5408/15
1,6 mm	KA 5401/16	KA 5402/16	KA 5403/16	KA 5404/16	KA 5405/16	KA 5406/16	KA 5407/16	KA 5408/16
1,7 mm	KA 5401/17	KA 5402/17	KA 5403/17	KA 5404/17	KA 5405/17	KA 5406/17	KA 5407/17	KA 5408/17
1,8 mm	KA 5401/18	KA 5402/18	KA 5403/18	KA 5404/18	KA 5405/18	KA 5406/18	KA 5407/18	KA 5408/18
2,0 mm	KA 5401/20	KA 5402/20	KA 5403/20	KA 5404/20	KA 5405/20	KA 5406/20	KA 5407/20	KA 5408/20
2,2 mm	KA 5401/22	KA 5402/22	KA 5403/22	KA 5404/22	KA 5405/22	KA 5406/22	KA 5407/22	KA 5408/22
2,5 mm	KA 5401/25	KA 5402/25	KA 5403/25	KA 5404/25	KA 5405/25	KA 5406/25	KA 5407/25	KA 5408/25
3,0 mm	KA 5401/30	KA 5402/30	KA 5403/30	KA 5404/30	KA 5405/30	KA 5406/30	KA 5407/30	KA 5408/30



KIRSCHNER

	60 mm	70 mm	80 mm	120 mm	140 mm	160 mm	230 mm	310 mm
0,6 mm	KA 5411/06	KA 5412/06	KA 5413/06	KA 5414/06	KA 5415/06	KA 5416/06	KA 5417/06	KA 5418/06
0,8 mm	KA 5411/08	KA 5412/08	KA 5413/08	KA 5414/08	KA 5415/08	KA 5416/08	KA 5417/08	KA 5418/08
0,9 mm	KA 5411/09	KA 5412/09	KA 5413/09	KA 5414/09	KA 5415/09	KA 5416/09	KA 5417/09	KA 5418/09
1,0 mm	KA 5411/10	KA 5412/10	KA 5413/10	KA 5414/10	KA 5415/10	KA 5416/10	KA 5417/10	KA 5418/10
1,2 mm	KA 5411/12	KA 5412/12	KA 5413/12	KA 5414/12	KA 5415/12	KA 5416/12	KA 5417/12	KA 5418/12
1,4 mm	KA 5411/14	KA 5412/14	KA 5413/14	KA 5414/14	KA 5415/14	KA 5416/14	KA 5417/14	KA 5418/14
1,5 mm	KA 5411/15	KA 5412/15	KA 5413/15	KA 5414/15	KA 5415/15	KA 5416/15	KA 5417/15	KA 5418/15
1,6 mm	KA 5411/16	KA 5412/16	KA 5413/16	KA 5414/16	KA 5415/16	KA 5416/16	KA 5417/16	KA 5418/16
1,7 mm	KA 5411/17	KA 5412/17	KA 5413/17	KA 5414/17	KA 5415/17	KA 5416/17	KA 5417/17	KA 5418/17
1,8 mm	KA 5411/18	KA 5412/18	KA 5413/18	KA 5414/18	KA 5415/18	KA 5416/18	KA 5417/18	KA 5418/18
2,0 mm	KA 5411/20	KA 5412/20	KA 5413/20	KA 5414/20	KA 5415/20	KA 5416/20	KA 5417/20	KA 5418/20
2,2 mm	KA 5411/22	KA 5412/22	KA 5413/22	KA 5414/22	KA 5415/22	KA 5416/22	KA 5417/22	KA 5418/22
2,5 mm	KA 5411/25	KA 5412/25	KA 5413/25	KA 5414/25	KA 5415/25	KA 5416/25	KA 5417/25	KA 5418/25
3,0 mm	KA 5411/30	KA 5412/30	KA 5413/30	KA 5414/30	KA 5415/30	KA 5416/30	KA 5417/30	KA 5418/30

**KA** ORTHOPÄDIE ORTHOPAEDIC ORTOPEDIA ORTHOPEDIE ORTOPEDIA

Kirschner Bohrdrähte  
Kirschner Wires  
Agujas Kirschner  
Broches de Kirschner  
Fili Kirschner



	60 mm	70 mm	80 mm	120 mm	140 mm	160 mm	230 mm	310 mm
0,6 mm	KA 5421/06	KA 5422/06	KA 5423/06	KA 5424/06	KA 5425/06	KA 5426/06	KA 5427/06	KA 5428/06
0,8 mm	KA 5421/08	KA 5422/08	KA 5423/08	KA 5424/08	KA 5425/08	KA 5426/08	KA 5427/08	KA 5428/08
0,9 mm	KA 5421/09	KA 5422/09	KA 5423/09	KA 5424/09	KA 5425/09	KA 5426/09	KA 5427/09	KA 5428/09
1,0 mm	KA 5421/10	KA 5422/10	KA 5423/10	KA 5424/10	KA 5425/10	KA 5426/10	KA 5427/10	KA 5428/10
1,2 mm	KA 5421/12	KA 5422/12	KA 5423/12	KA 5424/12	KA 5425/12	KA 5426/12	KA 5427/12	KA 5428/12
1,4 mm	KA 5421/14	KA 5422/14	KA 5423/14	KA 5424/14	KA 5425/14	KA 5426/14	KA 5427/14	KA 5428/14
1,5 mm	KA 5421/15	KA 5422/15	KA 5423/15	KA 5424/15	KA 5425/15	KA 5426/15	KA 5427/15	KA 5428/15
1,6 mm	KA 5421/16	KA 5422/16	KA 5423/16	KA 5424/16	KA 5425/16	KA 5426/16	KA 5427/16	KA 5428/16
1,7 mm	KA 5421/17	KA 5422/17	KA 5423/17	KA 5424/17	KA 5425/17	KA 5426/17	KA 5427/17	KA 5428/17
1,8 mm	KA 5421/18	KA 5422/18	KA 5423/18	KA 5424/18	KA 5425/18	KA 5426/18	KA 5427/18	KA 5428/18
2,0 mm	KA 5421/20	KA 5422/20	KA 5423/20	KA 5424/20	KA 5425/20	KA 5426/20	KA 5427/20	KA 5428/20
2,2 mm	KA 5421/22	KA 5422/22	KA 5423/22	KA 5424/22	KA 5425/22	KA 5426/22	KA 5427/22	KA 5428/22
2,5 mm	KA 5421/25	KA 5422/25	KA 5423/25	KA 5424/25	KA 5425/25	KA 5426/25	KA 5427/25	KA 5428/25
3,0 mm	KA 5421/30	KA 5422/30	KA 5423/30	KA 5424/30	KA 5425/30	KA 5426/30	KA 5427/30	KA 5428/30



	60 mm	70 mm	80 mm	120 mm	140 mm	160 mm	230 mm	310 mm
0,6 mm	KA 5431/06	KA 5432/06	KA 5433/06	KA 5434/06	KA 5435/06	KA 5436/06	KA 5437/06	KA 5438/06
0,8 mm	KA 5431/08	KA 5432/08	KA 5433/08	KA 5434/08	KA 5435/08	KA 5436/08	KA 5437/08	KA 5438/08
0,9 mm	KA 5431/09	KA 5432/09	KA 5433/09	KA 5434/09	KA 5435/09	KA 5436/09	KA 5437/09	KA 5438/09
1,0 mm	KA 5431/10	KA 5432/10	KA 5433/10	KA 5434/10	KA 5435/10	KA 5436/10	KA 5437/10	KA 5438/10
1,2 mm	KA 5431/12	KA 5432/12	KA 5433/12	KA 5434/12	KA 5435/12	KA 5436/12	KA 5437/12	KA 5438/12
1,4 mm	KA 5431/14	KA 5432/14	KA 5433/14	KA 5434/14	KA 5435/14	KA 5436/14	KA 5437/14	KA 5438/14
1,5 mm	KA 5431/15	KA 5432/15	KA 5433/15	KA 5434/15	KA 5435/15	KA 5436/15	KA 5437/15	KA 5438/15
1,6 mm	KA 5431/16	KA 5432/16	KA 5433/16	KA 5434/16	KA 5435/16	KA 5436/16	KA 5437/16	KA 5438/16
1,7 mm	KA 5431/17	KA 5432/17	KA 5433/17	KA 5434/17	KA 5435/17	KA 5436/17	KA 5437/17	KA 5438/17
1,8 mm	KA 5431/18	KA 5432/18	KA 5433/18	KA 5434/18	KA 5435/18	KA 5436/18	KA 5437/18	KA 5438/18
2,0 mm	KA 5431/20	KA 5432/20	KA 5433/20	KA 5434/20	KA 5435/20	KA 5436/20	KA 5437/20	KA 5438/20
2,2 mm	KA 5431/22	KA 5432/22	KA 5433/22	KA 5434/22	KA 5435/22	KA 5436/22	KA 5437/22	KA 5438/22
2,5 mm	KA 5431/25	KA 5432/25	KA 5433/25	KA 5434/25	KA 5435/25	KA 5436/25	KA 5437/25	KA 5438/25
3,0 mm	KA 5431/30	KA 5432/30	KA 5433/30	KA 5434/30	KA 5435/30	KA 5436/30	KA 5437/30	KA 5438/30



ORTHOPÄDIE ORTHOPAEDIC ORTOPEDIA ORTHOPEDIE ORTOPEDIA

Kirschner Bohrdrähte  
Kirschner Wires  
Agujas Kirschner  
Broches de Kirschner  
Fili Kirschner

AA  
AB  
AC  
AD  
AE  
AF  
AK  
AL  
AM  
AO  
AP  
AR  
KA  
KD  
KY



KIRSCHNER

	60 mm	70 mm	80 mm	120 mm	140 mm	160 mm	230 mm	310 mm
0,6 mm	KA 5451/06	KA 5452/06	KA 5453/06	KA 5454/06	KA 5455/06	KA 5456/06	KA 5457/06	KA 5458/06
0,8 mm	KA 5451/08	KA 5452/08	KA 5453/08	KA 5454/08	KA 5455/08	KA 5456/08	KA 5457/08	KA 5458/08
0,9 mm	KA 5451/09	KA 5452/09	KA 5453/09	KA 5454/09	KA 5455/09	KA 5456/09	KA 5457/09	KA 5458/09
1,0 mm	KA 5451/10	KA 5452/10	KA 5453/10	KA 5454/10	KA 5455/10	KA 5456/10	KA 5457/10	KA 5458/10
1,2 mm	KA 5451/12	KA 5452/12	KA 5453/12	KA 5454/12	KA 5455/12	KA 5456/12	KA 5457/12	KA 5458/12
1,4 mm	KA 5451/14	KA 5452/14	KA 5453/14	KA 5454/14	KA 5455/14	KA 5456/14	KA 5457/14	KA 5458/14
1,5 mm	KA 5451/15	KA 5452/15	KA 5453/15	KA 5454/15	KA 5455/15	KA 5456/15	KA 5457/15	KA 5458/15
1,6 mm	KA 5451/16	KA 5452/16	KA 5453/16	KA 5454/16	KA 5455/16	KA 5456/16	KA 5457/16	KA 5458/16
1,7 mm	KA 5451/17	KA 5452/17	KA 5453/17	KA 5454/17	KA 5455/17	KA 5456/17	KA 5457/17	KA 5458/17
1,8 mm	KA 5451/18	KA 5452/18	KA 5453/18	KA 5454/18	KA 5455/18	KA 5456/18	KA 5457/18	KA 5458/18
2,0 mm	KA 5451/20	KA 5452/20	KA 5453/20	KA 5454/20	KA 5455/20	KA 5456/20	KA 5457/20	KA 5458/20
2,2 mm	KA 5451/22	KA 5452/22	KA 5453/22	KA 5454/22	KA 5455/22	KA 5456/22	KA 5457/22	KA 5458/22
2,5 mm	KA 5451/25	KA 5452/25	KA 5453/25	KA 5454/25	KA 5455/25	KA 5456/25	KA 5457/25	KA 5458/25
3,0 mm	KA 5451/30	KA 5452/30	KA 5453/30	KA 5454/30	KA 5455/30	KA 5456/30	KA 5457/30	KA 5458/30



KIRSCHNER

	60 mm	70 mm	80 mm	120 mm	140 mm	160 mm	230 mm	310 mm
0,6 mm	KA 5461/06	KA 5462/06	KA 5463/06	KA 5464/06	KA 5465/06	KA 5466/06	KA 5467/06	KA 5468/06
0,8 mm	KA 5461/08	KA 5462/08	KA 5463/08	KA 5464/08	KA 5465/08	KA 5466/08	KA 5467/08	KA 5468/08
0,9 mm	KA 5461/09	KA 5462/09	KA 5463/09	KA 5464/09	KA 5465/09	KA 5466/09	KA 5467/09	KA 5468/09
1,0 mm	KA 5461/10	KA 5462/10	KA 5463/10	KA 5464/10	KA 5465/10	KA 5466/10	KA 5467/10	KA 5468/10
1,2 mm	KA 5461/12	KA 5462/12	KA 5463/12	KA 5464/12	KA 5465/12	KA 5466/12	KA 5467/12	KA 5468/12
1,4 mm	KA 5461/14	KA 5462/14	KA 5463/14	KA 5464/14	KA 5465/14	KA 5466/14	KA 5467/14	KA 5468/14
1,5 mm	KA 5461/15	KA 5462/15	KA 5463/15	KA 5464/15	KA 5465/15	KA 5466/15	KA 5467/15	KA 5468/15
1,6 mm	KA 5461/16	KA 5462/16	KA 5463/16	KA 5464/16	KA 5465/16	KA 5466/16	KA 5467/16	KA 5468/16
1,7 mm	KA 5461/17	KA 5462/17	KA 5463/17	KA 5464/17	KA 5465/17	KA 5466/17	KA 5467/17	KA 5468/17
1,8 mm	KA 5461/18	KA 5462/18	KA 5463/18	KA 5464/18	KA 5465/18	KA 5466/18	KA 5467/18	KA 5468/18
2,0 mm	KA 5461/20	KA 5462/20	KA 5463/20	KA 5464/20	KA 5465/20	KA 5466/20	KA 5467/20	KA 5468/20
2,2 mm	KA 5461/22	KA 5462/22	KA 5463/22	KA 5464/22	KA 5465/22	KA 5466/22	KA 5467/22	KA 5468/22
2,5 mm	KA 5461/25	KA 5462/25	KA 5463/25	KA 5464/25	KA 5465/25	KA 5466/25	KA 5467/25	KA 5468/25
3,0 mm	KA 5461/30	KA 5462/30	KA 5463/30	KA 5464/30	KA 5465/30	KA 5466/30	KA 5467/30	KA 5468/30

**KA** ORTHOPÄDIE ORTHOPAEDIC ORTOPEDIA ORTHOPEDIE ORTOPEDIA

Kirschner Bohrdrähte  
 Kirschner Wires  
 Agujas Kirschner  
 Broches de Kirschner  
 Fili Kirschner



	60 mm	70 mm	80 mm	120 mm	140 mm	160 mm	230 mm	310 mm
0,6 mm	KA 5471/06	KA 5472/06	KA 5473/06	KA 5474/06	KA 5475/06	KA 5476/06	KA 5477/06	KA 5478/06
0,8 mm	KA 5471/08	KA 5472/08	KA 5473/08	KA 5474/08	KA 5475/08	KA 5476/08	KA 5477/08	KA 5478/08
0,9 mm	KA 5471/09	KA 5472/09	KA 5473/09	KA 5474/09	KA 5475/09	KA 5476/09	KA 5477/09	KA 5478/09
1,0 mm	KA 5471/10	KA 5472/10	KA 5473/10	KA 5474/10	KA 5475/10	KA 5476/10	KA 5477/10	KA 5478/10
1,2 mm	KA 5471/12	KA 5472/12	KA 5473/12	KA 5474/12	KA 5475/12	KA 5476/12	KA 5477/12	KA 5478/12
1,4 mm	KA 5471/14	KA 5472/14	KA 5473/14	KA 5474/14	KA 5475/14	KA 5476/14	KA 5477/14	KA 5478/14
1,5 mm	KA 5471/15	KA 5472/15	KA 5473/15	KA 5474/15	KA 5475/15	KA 5476/15	KA 5477/15	KA 5478/15
1,6 mm	KA 5471/16	KA 5472/16	KA 5473/16	KA 5474/16	KA 5475/16	KA 5476/16	KA 5477/16	KA 5478/16
1,7 mm	KA 5471/17	KA 5472/17	KA 5473/17	KA 5474/17	KA 5475/17	KA 5476/17	KA 5477/17	KA 5478/17
1,8 mm	KA 5471/18	KA 5472/18	KA 5473/18	KA 5474/18	KA 5475/18	KA 5476/18	KA 5477/18	KA 5478/18
2,0 mm	KA 5471/20	KA 5472/20	KA 5473/20	KA 5474/20	KA 5475/20	KA 5476/20	KA 5477/20	KA 5478/20
2,2 mm	KA 5471/22	KA 5472/22	KA 5473/22	KA 5474/22	KA 5475/22	KA 5476/22	KA 5477/22	KA 5478/22
2,5 mm	KA 5471/25	KA 5472/25	KA 5473/25	KA 5474/25	KA 5475/25	KA 5476/25	KA 5477/25	KA 5478/25
3,0 mm	KA 5471/30	KA 5472/30	KA 5473/30	KA 5474/30	KA 5475/30	KA 5476/30	KA 5477/30	KA 5478/30



**KIRSCHNER**

- 15,5 cm KA 5540/15
- 19,0 cm KA 5540/19
- 32,0 cm KA 5540/32



**SCHANZ**

	100 mm	120 mm	150 mm	170 mm	200 mm	250 mm
3,0 mm	KA 5560/30	KA 5562/30	KA 5564/30	KA 5566/30	KA 5568/30	KA 5570/30
3,5 mm	KA 5560/35	KA 5562/35	KA 5564/35	KA 5566/35	KA 5568/35	KA 5570/35
4,0 mm	KA 5560/40	KA 5562/40	KA 5564/40	KA 5566/40	KA 5568/40	KA 5570/40
4,5 mm	KA 5560/45	KA 5562/45	KA 5564/45	KA 5566/45	KA 5568/45	KA 5570/45
5,0 mm	KA 5560/50	KA 5562/50	KA 5564/50	KA 5566/50	KA 5568/50	KA 5570/50

AA  
AB  
AC  
AD  
AE  
AF  
AK  
AL  
AM  
AO  
AP  
AR  
KA  
KD  
KU  
KY

KA





Knochen-Schrauben  
 Bone Screws  
 Tornillos para huesos  
 Vis d'ostéo-synthèse  
 Viti per ossa

CORTICALIS

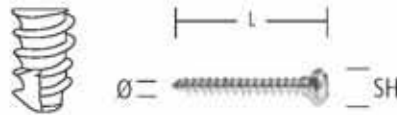

	SH 3,0 mm	SH 3,0 mm
		TITAN
L	Ø 1,5 mm	Ø 1,5 mm
4 mm	KA 5600/04	KA 5601/04
6 mm	KA 5600/06	KA 5601/06
7 mm	KA 5600/07	KA 5601/07
8 mm	KA 5600/08	KA 5601/08
9 mm	KA 5600/09	KA 5601/09
10 mm	KA 5600/10	KA 5601/10
11 mm	KA 5600/11	KA 5601/11
12 mm	KA 5600/12	KA 5601/12
14 mm	KA 5600/14	KA 5601/14
16 mm	KA 5600/16	KA 5601/16
18 mm	KA 5600/18	KA 5601/18
20 mm	KA 5600/20	KA 5601/20
22 mm		
24 mm		
26 mm		
28 mm		
30 mm		
32 mm		
34 mm		
36 mm		
38 mm		
40 mm		

SH 4,0 mm	SH 4,0 mm
	TITAN
Ø 2,0 mm	Ø 2,0 mm
KA 5602/04	KA 5603/04
KA 5602/06	KA 5603/06
KA 5602/08	KA 5603/08
KA 5602/10	KA 5603/10
KA 5602/12	KA 5603/12
KA 5602/14	KA 5603/14
KA 5602/16	KA 5603/16
KA 5602/18	KA 5603/18
KA 5602/20	KA 5603/20
KA 5602/22	KA 5603/22
KA 5602/24	KA 5603/24
KA 5602/26	KA 5603/26
KA 5602/28	KA 5603/28
KA 5602/30	KA 5603/30
KA 5602/32	KA 5603/32
KA 5602/34	KA 5603/34
KA 5602/36	KA 5603/36
KA 5602/38	KA 5603/38

SH 5,0 mm	SH 5,0 mm
	TITAN
Ø 2,7 mm	Ø 2,7 mm
KA 5604/06	KA 5605/06
KA 5604/08	KA 5605/08
KA 5604/10	KA 5605/10
KA 5604/12	KA 5605/12
KA 5604/14	KA 5605/14
KA 5604/16	KA 5605/16
KA 5604/18	KA 5605/18
KA 5604/20	KA 5605/20
KA 5604/22	KA 5605/22
KA 5604/24	KA 5605/24
KA 5604/26	KA 5605/26
KA 5604/28	KA 5605/28
KA 5604/30	KA 5605/30
KA 5604/32	KA 5605/32
KA 5604/34	KA 5605/34
KA 5604/36	KA 5605/36
KA 5604/38	KA 5605/38
KA 5604/40	KA 5605/40



KA 5690/11

KA 5690/15

KA 5690/20

AA  
AB  
AC  
AD  
AE  
AF  
AK  
AL  
AM  
AO  
AP  
AR  
KA  
KD  
KU  
KY

Knochen-Schrauben  
Bone Screws  
Tomillos para huesos  
Vis d'ostéo-synthèse  
Viti per ossa

**CORTICALIS**

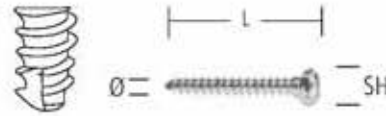

	SH 6,0 mm	SH 6,0 mm	SH 8,0 mm	SH 8,0 mm
		TITAN		TITAN
L	Ø 3,5 mm	Ø 3,5 mm	Ø 4,5 mm	Ø 4,5 mm
10 mm	KA 5606/10	KA 5607/10		
12 mm	KA 5606/12	KA 5607/12		
14 mm	KA 5606/14	KA 5607/14	KA 5608/14	KA 5609/14
16 mm	KA 5606/16	KA 5607/16	KA 5608/16	KA 5609/16
18 mm	KA 5606/18	KA 5607/18	KA 5608/18	KA 5609/18
20 mm	KA 5606/20	KA 5607/20	KA 5608/20	KA 5609/20
22 mm	KA 5606/22	KA 5607/22	KA 5608/22	KA 5609/22
24 mm	KA 5606/24	KA 5607/24	KA 5608/24	KA 5609/24
26 mm	KA 5606/26	KA 5607/26	KA 5608/26	KA 5609/26
28 mm	KA 5606/28	KA 5607/28	KA 5608/28	KA 5609/28
30 mm	KA 5606/30	KA 5607/30	KA 5608/30	KA 5609/30
32 mm	KA 5606/32	KA 5607/32	KA 5608/32	KA 5609/32
34 mm			KA 5608/34	KA 5609/34
36 mm	KA 5606/36	KA 5607/36	KA 5608/36	KA 5609/36
38 mm			KA 5608/38	KA 5609/38
40 mm	KA 5606/40	KA 5607/40	KA 5608/40	KA 5609/40
42 mm			KA 5608/42	KA 5609/42
44 mm			KA 5608/44	KA 5609/44
45 mm	KA 5606/45	KA 5607/45		
46 mm			KA 5608/46	KA 5609/46
48 mm			KA 5608/48	KA 5609/48
50 mm	KA 5606/50	KA 5607/50	KA 5608/50	KA 5609/50
52 mm			KA 5608/52	KA 5609/52
54 mm			KA 5608/54	KA 5609/54
55 mm	KA 5606/55	KA 5607/55		
56 mm			KA 5608/56	KA 5609/56
58 mm			KA 5608/58	KA 5609/58
60 mm	KA 5606/60	KA 5607/60	KA 5608/60	KA 5609/60
62 mm			KA 5608/62	KA 5609/62
64 mm			KA 5608/64	KA 5609/64
65 mm	KA 5606/65	KA 5607/65		
68 mm			KA 5608/68	KA 5609/68
70 mm	KA 5606/70	KA 5607/70	KA 5608/70	KA 5609/70
72 mm			KA 5608/72	KA 5609/72
75 mm	KA 5606/75	KA 5607/75		
76 mm			KA 5608/76	KA 5609/76
80 mm	KA 5606/80	KA 5607/80	KA 5608/80	KA 5609/80
85 mm	KA 5606/85	KA 5607/85	KA 5608/85	KA 5609/85
90 mm	KA 5606/90	KA 5607/90	KA 5608/90	KA 5609/90
95 mm	KA 5606/95	KA 5607/95	KA 5608/95	KA 5609/95
100 mm	KA 5606/96	KA 5607/96	KA 5608/96	KA 5609/96
105 mm	KA 5606/97	KA 5607/97	KA 5608/97	KA 5609/97
110 mm	KA 5606/98	KA 5607/98	KA 5608/98	KA 5609/98



KA 5690/25

KA 5690/32

Knochen-Schrauben  
 Bone Screws  
 Tornillos para huesos  
 Vis d'ostéo-synthèse  
 Viti per ossa

SPONGIOSA

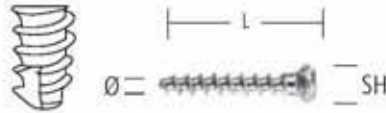

	SH 6,0 mm	SH 6,0 mm
		TITAN
L	Ø 4,0 mm	Ø 4,0 mm
10 mm	KA 5620/10	KA 5621/10
11 mm	KA 5620/11	KA 5621/11
12 mm	KA 5620/12	KA 5621/12
14 mm	KA 5620/14	KA 5621/14
16 mm	KA 5620/16	KA 5621/16
18 mm	KA 5620/18	KA 5621/18
20 mm	KA 5620/20	KA 5621/20
22 mm	KA 5620/22	KA 5621/22
24 mm	KA 5620/24	KA 5621/24
26 mm	KA 5620/26	KA 5621/26
28 mm	KA 5620/28	KA 5621/28
30 mm	KA 5620/30	KA 5621/30
35 mm	KA 5620/35	KA 5621/35
40 mm	KA 5620/40	KA 5621/40
45 mm	KA 5620/45	KA 5621/45
50 mm	KA 5620/50	KA 5621/50
55 mm	KA 5620/55	KA 5621/55
60 mm	KA 5620/60	KA 5621/60

	SH 8,0 mm	SH 8,0 mm
		TITAN
L	Ø 6,5 mm	Ø 6,5 mm
25 mm	KA 5624/25	KA 5625/25
30 mm	KA 5624/30	KA 5625/30
35 mm	KA 5624/35	KA 5625/35
40 mm	KA 5624/40	KA 5625/40
45 mm	KA 5624/45	KA 5625/45
50 mm	KA 5624/50	KA 5625/50
55 mm	KA 5624/55	KA 5625/55
60 mm	KA 5624/60	KA 5625/60
65 mm	KA 5624/65	KA 5625/65
70 mm	KA 5624/70	KA 5625/70
75 mm	KA 5624/75	KA 5625/75
80 mm	KA 5624/80	KA 5625/80
85 mm	KA 5624/85	KA 5625/85
90 mm	KA 5624/90	KA 5625/90
95 mm	KA 5624/95	KA 5625/95
100 mm	KA 5624/96	KA 5625/96
105 mm	KA 5624/97	KA 5625/97
110 mm	KA 5624/98	KA 5625/98



KA 5690/25



KA 5690/32

7 mm



KA 5698/07

13 mm



KA 5698/13

AA  
 AB  
 AC  
 AD  
 AE  
 AF  
 AK  
 AL  
 AM  
 AO  
 AP  
 AR  
 KA  
 KD  
 KU  
 KY



Knochen-Schrauben  
 Bone Screws  
 Tornillos para huesos  
 Vis d'ostéo-synthèse  
 Viti per ossa

**SPONGIOSA**

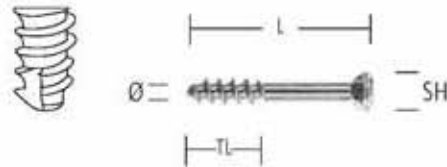

		SH 6,0 mm	SH 6,0 mm
			TITAN
L	TL	Ø 4,0 mm	Ø 4,0 mm
10 mm	5 mm	KA 5630/10	KA 5631/10
12 mm	5 mm	KA 5630/12	KA 5631/12
14 mm	5 mm	KA 5630/14	KA 5631/14
16 mm	6 mm	KA 5630/16	KA 5631/16
18 mm	7 mm	KA 5630/18	KA 5631/18
20 mm	8 mm	KA 5630/20	KA 5631/20
22 mm	9 mm	KA 5630/22	KA 5631/22
24 mm	10 mm	KA 5630/24	KA 5631/24
26 mm	12 mm	KA 5630/26	KA 5631/26
28 mm	14 mm	KA 5630/28	KA 5631/28
30 mm	14 mm	KA 5630/30	KA 5631/30
35 mm	14 mm	KA 5630/35	KA 5631/35
40 mm	14 mm	KA 5630/40	KA 5631/40
45 mm	15 mm	KA 5630/45	KA 5631/45
50 mm	15 mm	KA 5630/50	KA 5631/50



KA 5690/25

7 mm



KA 5698/07

Knochen-Schrauben  
Bone Screws  
Tornillos para huesos  
Vis d'ostéo-synthèse  
Viti per ossa

SPONGIOSA

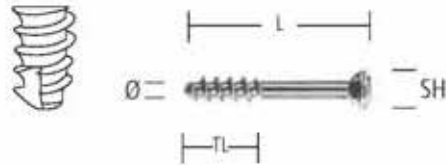

		SH 8,0 mm	SH 8,0 mm			SH 8,0 mm	SH 8,0 mm
			TITAN				TITAN
L	TL	Ø 6,5 mm	Ø 6,5 mm	TL	Ø 6,5 mm	Ø 6,5 mm	
30 mm	16 mm	KA 5632/30	KA 5633/30				
35 mm	16 mm	KA 5632/35	KA 5633/35				
40 mm	16 mm	KA 5632/40	KA 5633/40				
45 mm	16 mm	KA 5632/45	KA 5633/45	32 mm	KA 5634/45	KA 5635/45	
50 mm	16 mm	KA 5632/50	KA 5633/50	32 mm	KA 5634/50	KA 5635/50	
55 mm	16 mm	KA 5632/55	KA 5633/55	32 mm	KA 5634/55	KA 5635/55	
60 mm	16 mm	KA 5632/60	KA 5633/60	32 mm	KA 5634/60	KA 5635/60	
65 mm	16 mm	KA 5632/65	KA 5633/65	32 mm	KA 5634/65	KA 5635/65	
70 mm	16 mm	KA 5632/70	KA 5633/70	32 mm	KA 5634/70	KA 5635/70	
75 mm	16 mm	KA 5632/75	KA 5633/75	32 mm	KA 5634/75	KA 5635/75	
80 mm	16 mm	KA 5632/80	KA 5633/80	32 mm	KA 5634/80	KA 5635/80	
85 mm	16 mm	KA 5632/85	KA 5633/85	32 mm	KA 5634/85	KA 5635/85	
90 mm	16 mm	KA 5632/90	KA 5633/90	32 mm	KA 5634/90	KA 5635/90	
95 mm	16 mm	KA 5632/95	KA 5633/95	32 mm	KA 5634/95	KA 5635/95	
100 mm	16 mm	KA 5632/96	KA 5633/96	32 mm	KA 5634/96	KA 5635/96	
105 mm	16 mm	KA 5632/97	KA 5633/97	32 mm	KA 5634/97	KA 5635/97	
110 mm	16 mm	KA 5632/98	KA 5633/98	32 mm	KA 5634/98	KA 5635/98	



KA 5690/32

KA 5690/32

13 mm



KA 5698/13

KA 5698/13

AA  
AB  
AC  
AD  
AE  
AF  
AK  
AL  
AM  
AO  
AP  
AR  
KA  
KD  
KU  
KY

Knochen-Schrauben  
Bone Screws  
Tornillos para huesos  
Vis d'ostéo-synthèse  
Viti per ossa

selbstschneidend  
self-cutting  
rosca cortante  
auto-taraudeuses  
filetto tagliante

**CORTICALIS  
CANNULATED**

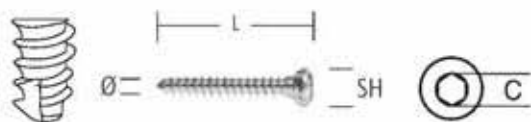

	SH 6,0 mm	SH 8,0 mm
	C 1,6 mm	C 1,8 mm
	TITAN	TITAN
L	Ø 3,5 mm	Ø 4,5 mm
12 mm	KA 5640/12	
14 mm	KA 5640/14	
16 mm	KA 5640/16	
18 mm	KA 5640/18	
20 mm	KA 5640/20	
22 mm	KA 5640/22	
24 mm	KA 5640/24	
26 mm	KA 5640/26	
28 mm	KA 5640/28	
30 mm	KA 5640/30	KA 5642/30
32 mm	KA 5640/32	KA 5642/32
34 mm	KA 5640/34	KA 5642/34
36 mm	KA 5640/36	KA 5642/36
38 mm	KA 5640/38	KA 5642/38
40 mm	KA 5640/40	KA 5642/40
42 mm	KA 5640/42	KA 5642/42
44 mm	KA 5640/44	KA 5642/44
46 mm	KA 5640/46	KA 5642/46
48 mm	KA 5640/48	KA 5642/48
52 mm	KA 5640/52	
57 mm	KA 5640/57	KA 5642/57
62 mm	KA 5640/62	KA 5642/62
67 mm	KA 5640/67	KA 5642/67
72 mm	KA 5640/72	KA 5642/72



KA 5690/25	KA 5690/32
------------	------------

**CORTICALIS  
CANNULATED**

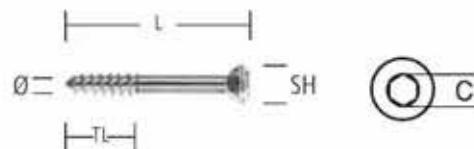

		SH 6,0 mm	SH 8,0 mm
		C 1,6 mm	C 1,8 mm
		TITAN	TITAN
L	TL	Ø 4,0 mm	Ø 4,5 mm
30 mm	20 mm	KA 5644/30	KA 5646/30
32 mm	20 mm	KA 5644/32	KA 5646/32
34 mm	20 mm	KA 5644/34	KA 5646/34
35 mm	20 mm		
40 mm	20 mm	KA 5644/40	KA 5646/40
42 mm	20 mm	KA 5644/42	KA 5646/42
44 mm	20 mm	KA 5644/44	KA 5646/44
45 mm	20 mm		
46 mm	20 mm	KA 5644/46	KA 5646/46
48 mm	20 mm	KA 5644/48	KA 5646/48
50 mm	20 mm	KA 5644/50	KA 5646/50
55 mm	20 mm	KA 5644/55	KA 5646/55
60 mm	20 mm	KA 5644/60	KA 5646/60
65 mm	20 mm	KA 5644/65	KA 5646/65
70 mm	20 mm	KA 5644/70	KA 5646/70



KA 5690/25	KA 5690/32
------------	------------



ORTHOPÄDIE ORTHOPAEDIC ORTOPEDIA ORTHOPEDIE ORTOPEDIA

Knochen-Schrauben  
Bone Screws  
Tornillos para huesos  
Vis d'ostéo-synthèse  
Viti per ossa

SPONGIOSA  
CANNULATED

selbstschneidend  
self-cutting  
rosca cortante  
auto-taraudeuses  
filetto tagliante

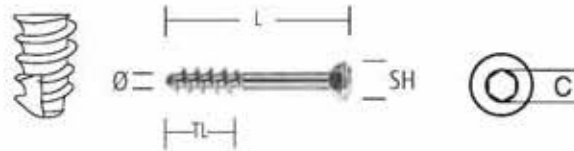

		SH 8,0 mm
		C 2,0 mm
		TITAN
L	TL	Ø 5,0 mm
30 mm	20 mm	KA 5648/30
32 mm	20 mm	KA 5648/32
34 mm	20 mm	KA 5648/34
40 mm	20 mm	KA 5648/40
42 mm	20 mm	KA 5648/42
44 mm	20 mm	KA 5648/44
46 mm	20 mm	KA 5648/46
48 mm	20 mm	KA 5648/48
50 mm	20 mm	KA 5648/50
55 mm	20 mm	KA 5648/55
60 mm	20 mm	KA 5648/60
65 mm	20 mm	KA 5648/65
70 mm	20 mm	KA 5648/70

		SH 8,0 mm
		C 3,2 mm
		TITAN
L	TL	Ø 6,5 mm
35 mm	25 mm	KA 5649/35
40 mm	25 mm	KA 5649/40
45 mm	25 mm	KA 5649/45
50 mm	25 mm	KA 5649/50
55 mm	25 mm	KA 5649/55
60 mm	25 mm	KA 5649/60
65 mm	25 mm	KA 5649/65
70 mm	25 mm	KA 5649/70
75 mm	25 mm	KA 5649/75
80 mm	25 mm	KA 5649/80
85 mm	25 mm	KA 5649/85
90 mm	25 mm	KA 5649/90
95 mm	25 mm	KA 5649/95
100 mm	25 mm	KA 5650/01
105 mm	25 mm	KA 5650/02
110 mm	25 mm	KA 5650/03
115 mm	25 mm	KA 5650/04
120 mm	25 mm	KA 5650/05
125 mm	25 mm	KA 5650/06
130 mm	25 mm	KA 5650/07



KA 5690/32

13 mm



KA 5698/13



KA 5690/25

13 mm



KA 5698/13

AA  
AB  
AC  
AD  
AE  
AF  
AK  
AL  
AM  
AO  
AP  
AR  
KA  
KD  
KU  
KY

Knochen-Schrauben  
 Bone Screws  
 Tornillos para huesos  
 Vis d'ostéo-synthèse  
 Viti per ossa

**MALLEOLAR**

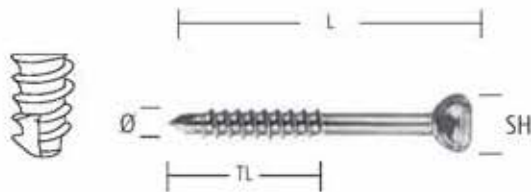

		SH 8,0 mm	SH 8,0 mm
			TITAN
L	TL	Ø 4,5 mm	Ø 4,5 mm
30 mm	15 mm	KA 5655/30	KA 5656/30
35 mm	18 mm	KA 5655/35	KA 5656/35
40 mm	20 mm	KA 5655/40	KA 5656/40
45 mm	22 mm	KA 5655/45	KA 5656/45
50 mm	24 mm	KA 5655/50	KA 5656/50
55 mm	26 mm	KA 5655/55	KA 5656/55
60 mm	28 mm	KA 5655/60	KA 5656/60
65 mm	30 mm	KA 5655/65	KA 5656/65
70 mm	32 mm	KA 5655/70	KA 5656/70



KA 5690/32

Vorbohrer für Knochen-Schrauben  
 Drill Bit for Bone Screws  
 Broca para tornillos para huesos  
 Alésoir pour Vis d'ostéo-synthèse  
 Alesatore per Viti per ossa



Ø	L	
1,1 mm	52 mm	KA 5690/11
1,5 mm	100 mm	KA 5690/15
2,0 mm	100 mm	KA 5690/20
2,5 mm	111 mm	KA 5690/25
3,2 mm	130 mm	KA 5690/32

AA

AB

AC

AD

AE

AF

AK

AL

AM

AO

AP

AR

KA

KD

KU

KY



---

DARM, MAGEN  
INTESTINES, STOMACH  
INTESTINOS, ESTOMAGO  
INTESTINS, ESTOMAC  
INTESTINI, STOMACO

**KD**

**nopa**<sup>®</sup> instruments



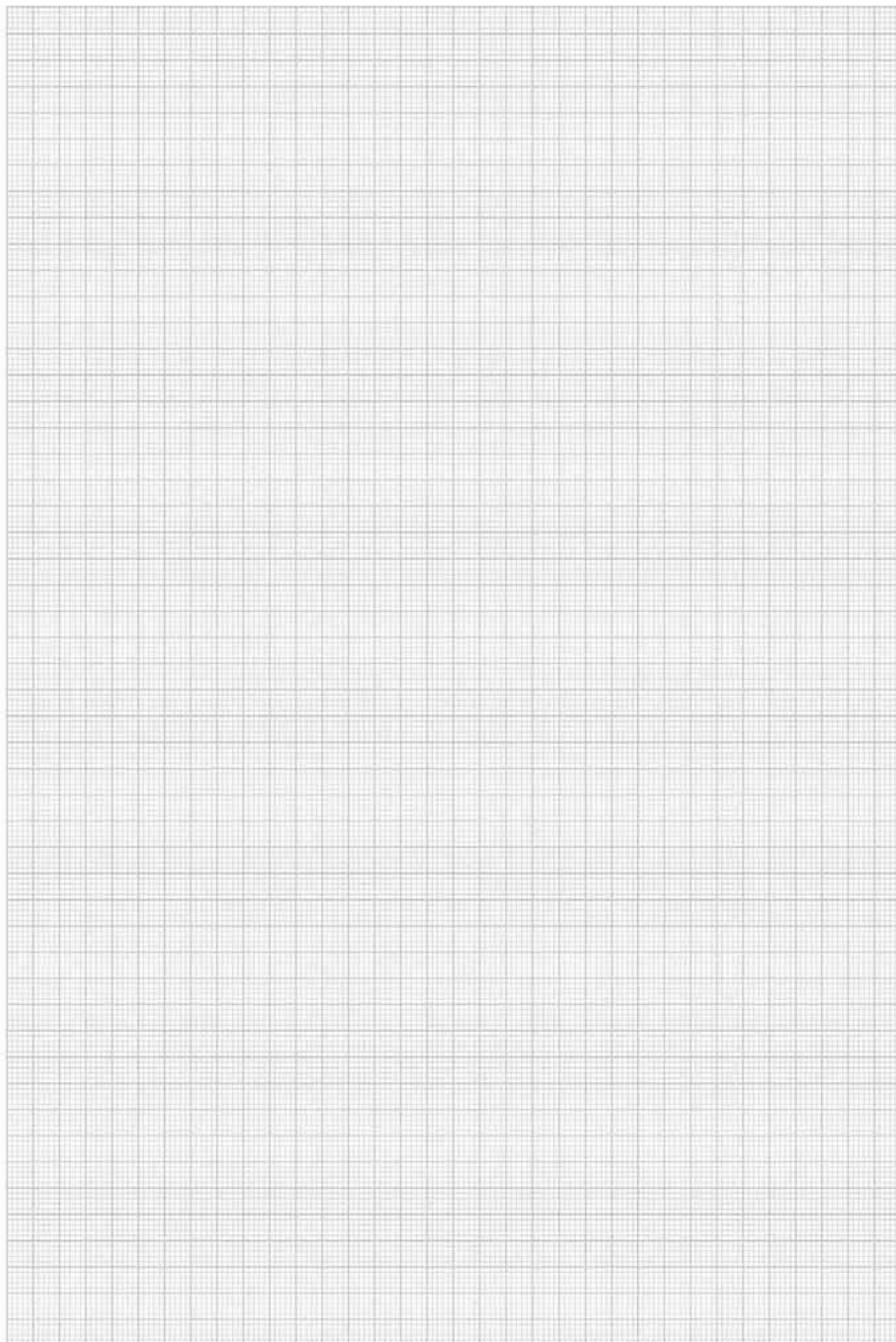



Gewebefasszängchen, Darmfasszangen  
 Tissue Seizing Forceps  
 Pinzas para coger tejidos e intestinos  
 Pincès pour saisir le tissu et l'intestin  
 Pinze per afferrare tessuti e l'intestino



**ALLIS-BABY 4:5**  
 KD 050/12  
 12,5 cm/5"



**ALLIS 4:5**  
 KD 054/15  
 15,0 cm/6"



**ALLIS 5:6**  
 15,0 cm/6"    KD 055/15  
 19,0 cm/7 1/2"    KD 055/19  
 25,0 cm/10"    KD 055/25  
 36,0 cm/14"    KD 055/36



**ALLIS**

KD 058/16  
 16,0 cm/6 1/4"

KD 058/20  
 20,0 cm/8"

KD 058/25  
 25,0 cm/10"

KD 058/30  
 30,0 cm/12"



**ALLIS-ADAIR 10:11**  
 KD 060/15  
 15,0 cm/6"

AA  
 AB  
 AC  
 AD  
 AE  
 AF  
 AK  
 AL  
 AM  
 AO  
 AP  
 AR  
 KA  
 KD  
 KU  
 KY

Gewebefasszängchen, Darmfasszangen  
 Tissue Seizing Forceps  
 Pinzas para coger tejidos e intestinos  
 Pincès pour saisir le tissu et l'intestin  
 Pinze per afferrare tessuti e l'intestino

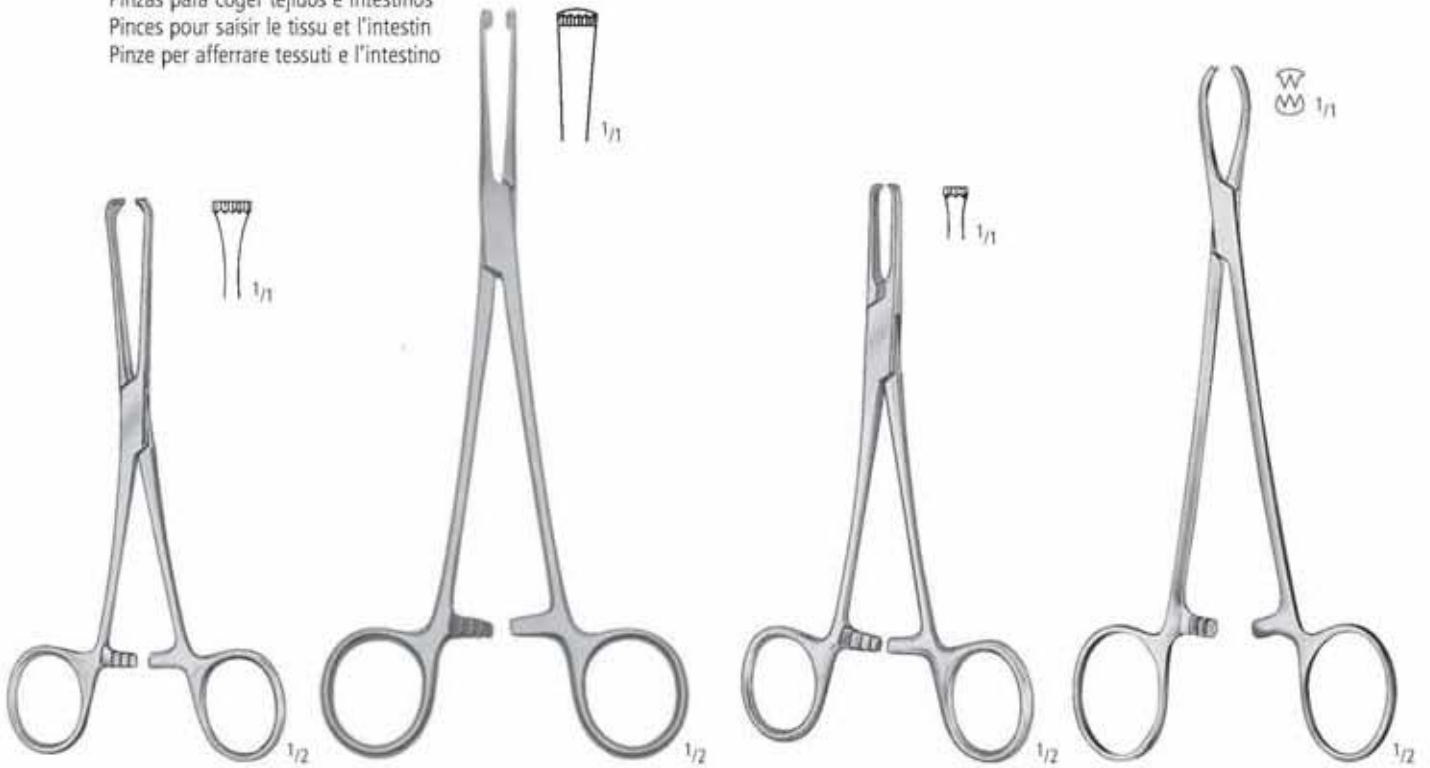

**BOYS-ALLIS 5:6**  
 KD 065/15  
 15,0 cm/6"

**LOCKWOOD-ALLIS 5:6**  
 KD 067/20  
 20,0 cm/8"

**JUDD-ALLIS 3:4**  
 15,0 cm/6"    KD 070/15  
 19,0 cm/7 1/2"    KD 070/19

**LITTLEWOOD**  
 KD 075/18  
 18,0 cm/7"



**THOMS-ALLIS 6:7**  
 KD 080/20  
 20,0 cm/8"

**LOCKWOOD**  
 KD 085/20  
 20,0 cm/8"

**WILLIAMS**  
 KD 090/16  
 16,0 cm/6 1/4"

Darmfasszangen  
 Intestinal Tissue Forceps  
 Pinzas para coger intestinos  
 Pinces pour saisir l'intestin  
 Pinze per afferrare l'intestino



**BABCOCK**  
 16,0 cm/6 1/4" KD 100/16  
 20,0 cm/8" KD 100/20

**BABCOCK**

KD 111/16  
 16,0 cm/6 1/4"

KD 111/18  
 18,0 cm/7"

KD 111/20  
 20,0 cm/8"

KD 111/24  
 24,0 cm/9 1/2"

KD 111/36  
 36,0 cm/14"

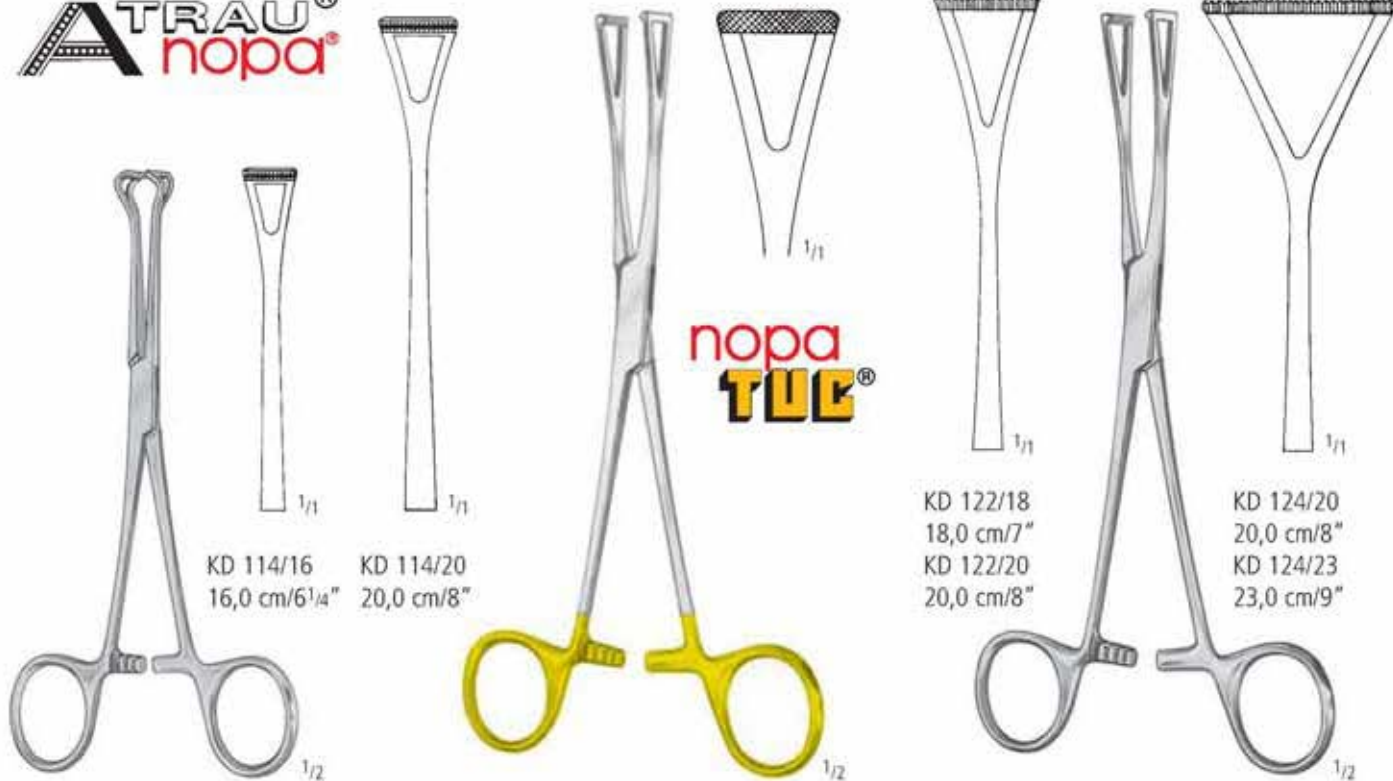

**BABCOCK**

**DUVAL**  
 KD 120/20  
 20,0 cm/8"

**DUVAL**

KD 122/18  
 18,0 cm/7"  
 KD 122/20  
 20,0 cm/8"

KD 124/20  
 20,0 cm/8"  
 KD 124/23  
 23,0 cm/9"

AA  
 AB  
 AC  
 AD  
 AE  
 AF  
 AK  
 AL  
 AM  
 AO  
 AP  
 AR  
 KA  
**KD**  
 KU  
 KY

Magen- und Darmklemmen  
 Stomach and Intestinal Clamp Forceps  
 Pinzas-clamps estomacales e intestinales  
 Pincés-clamps stomacales et pour l'intestin  
 Pinze stomacali e intestinali

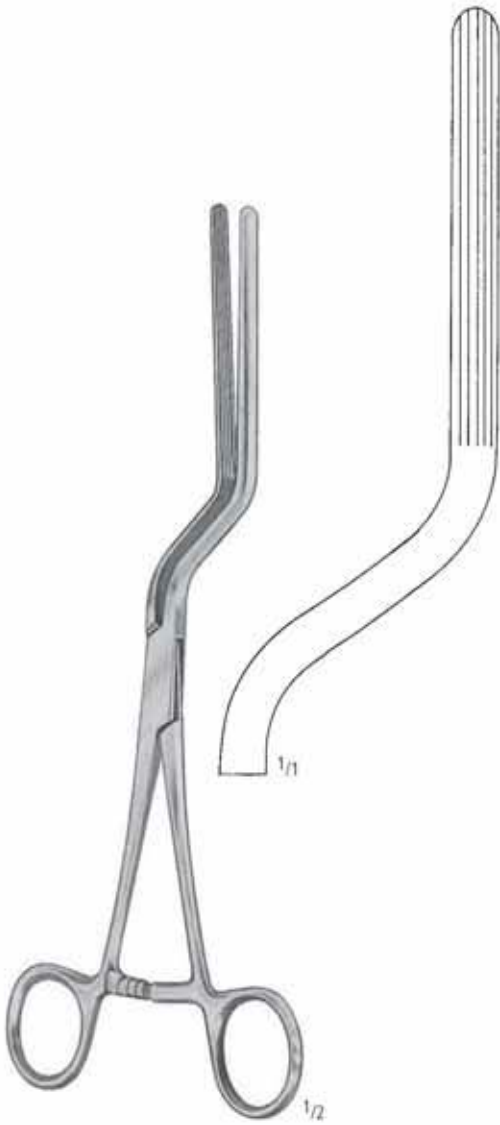

**BRUNNER**  
 KD 180/24  
 24,0 cm/9<sup>1</sup>/<sub>2</sub>"

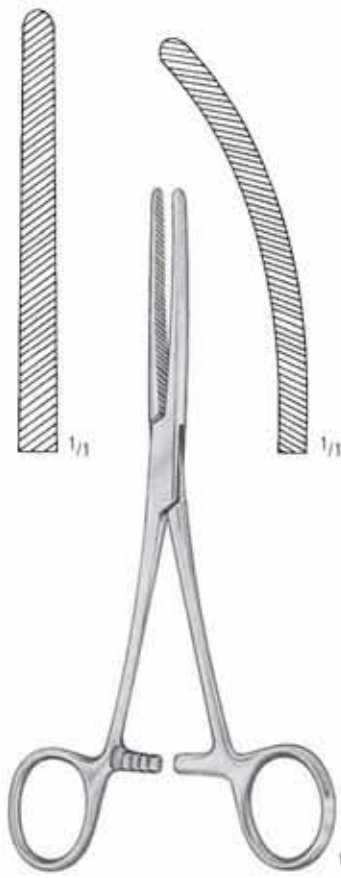

**BABY-DOYEN**  
 KD 190/16 16,5 cm/6<sup>1</sup>/<sub>2</sub>"    KD 191/16  
 KD 190/18 18,0 cm/7"    KD 191/18

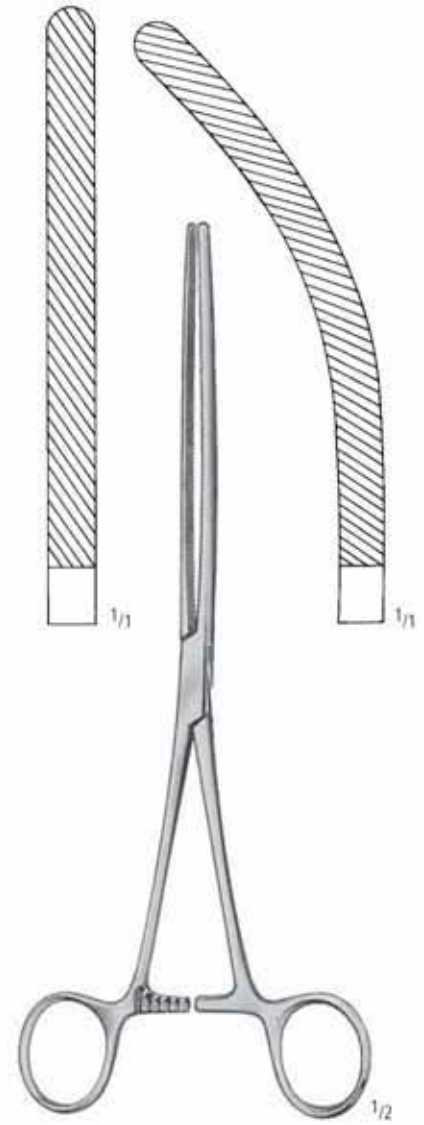

**DOYEN**  
 KD 200/21 21,0 cm/8<sup>1</sup>/<sub>4</sub>"    KD 201/21  
 KD 200/23 23,0 cm/9"    KD 201/23

Magen- und Darmklemmen  
 Stomach and Intestinal Clamp Forceps  
 Pinzas-clamps estomacales e intestinales  
 Pincas-clamps stomacales et pour l'intestin  
 Pinze stomacali e intestinali

AA  
 AB  
 AC  
 AD  
 AE  
 AF  
 AK  
 AL  
 AM  
 AO  
 AP  
 AR  
 KA  
 KU  
 KY

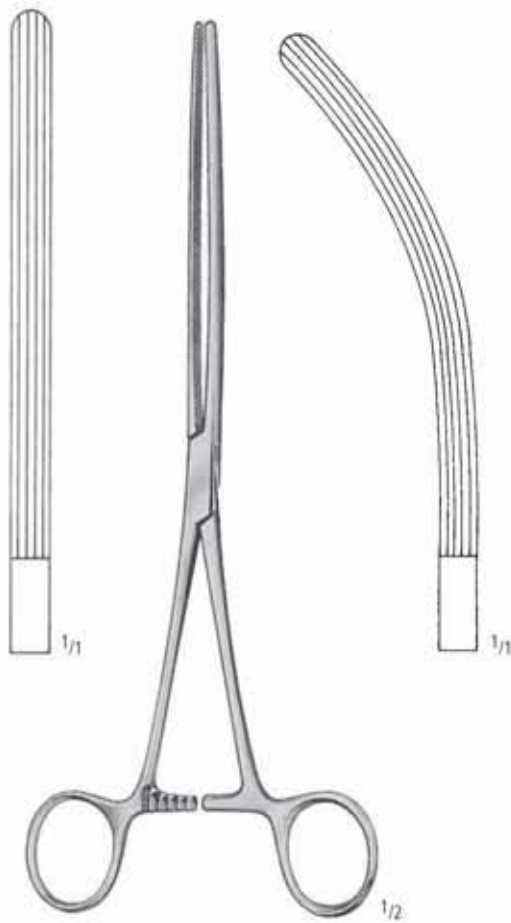

**MAYO-ROBSON**

- |           |   |           |
|-----------|---|-----------|
| KD 210/21 | 21,0 cm/8 <sup>1</sup> / <sub>4</sub> " | KD 211/21 |
| KD 210/23 | 23,0 cm/9"                              | KD 211/23 |
| KD 210/25 | 25,0 cm/10"                             | KD 211/25 |

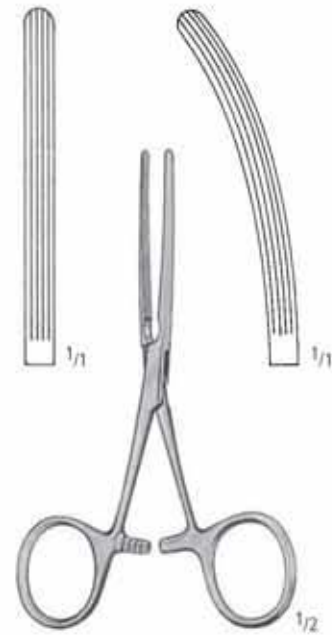

**BABY-KOCHER**

- |           |            |           |
|-----------|------------|-----------|
| KD 212/13 | 13,0 cm/5" | KD 213/13 |
|-----------|------------|-----------|

**KD**



Magen- und Darmklemmen  
 Stomach and Intestinal Clamp Forceps  
 Pinzas-clamps estomacales e intestinales  
 Pincas-clamps stomacales et pour l'intestin  
 Pinze stomacali e intestinali



**KOCHER**

KD 214/22	22,0 cm/8 <sup>3</sup> / <sub>4</sub> "	KD 215/22
KD 214/25	25,0 cm/10"	KD 215/25
KD 214/28	28,0 cm/11"	KD 215/28

sehr elastisch - very elastic - muy elásticas - très élastiques - molto elastiche



Magen- und Darmklemmen  
 Stomach and Intestinal Clamp Forceps  
 Pinzas-clamps estomacales e intestinales  
 Pincas-clamps stomacales et pour l'intestin  
 Pinze stomacali e intestinali

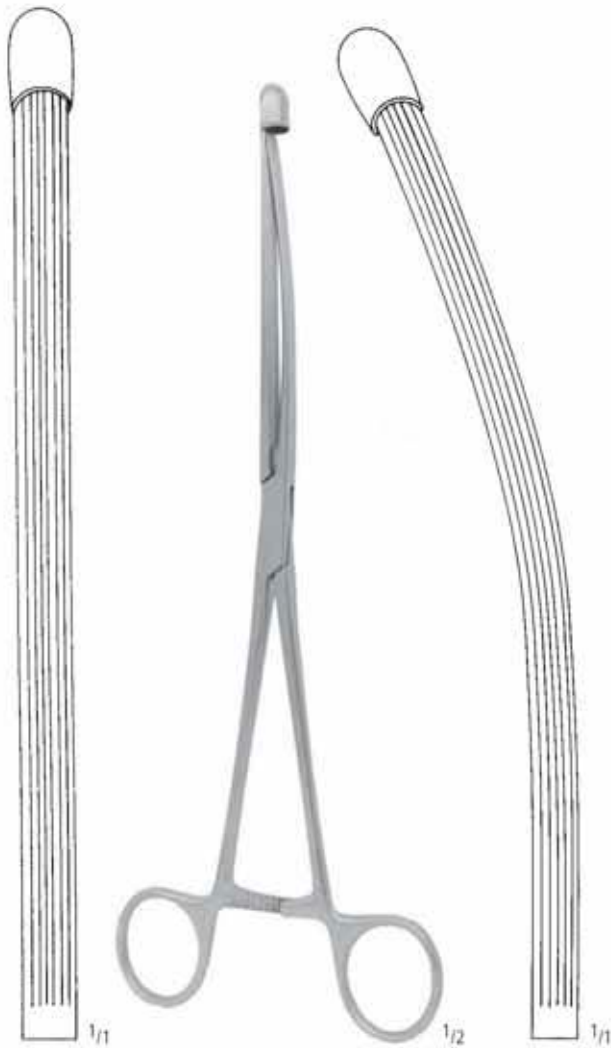

KD 224/25

**NUSSBAUM**  
 25,0 cm/10"

KD 225/25

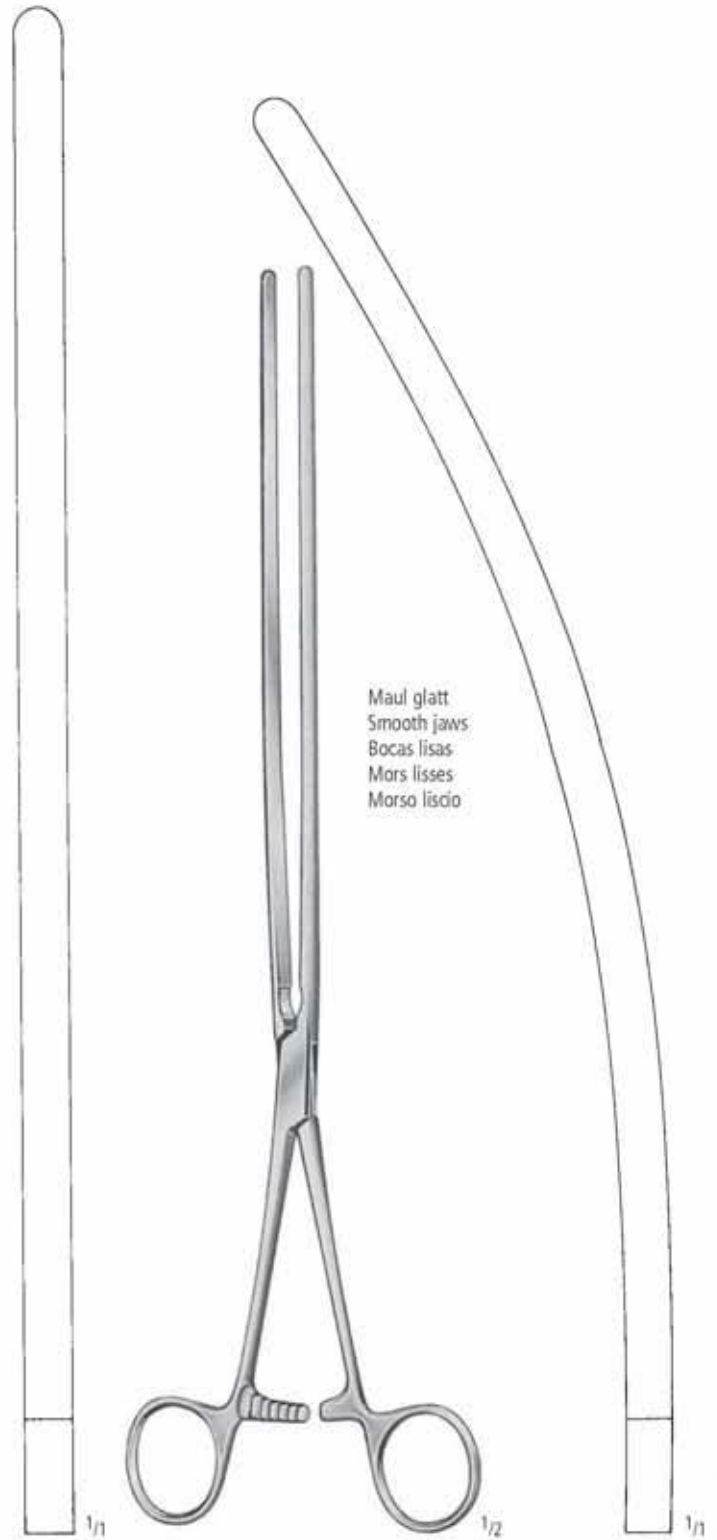

Maul glatt  
 Smooth jaws  
 Bocas lisas  
 Mors lisses  
 Morso liscio

KD 230/25  
 KD 230/33

**SCUDDER**  
 25,0 cm/10"  
 33,0 cm/13"

KD 231/25  
 KD 231/33

AA  
 AB  
 AC  
 AD  
 AE  
 AF  
 AG  
 AH  
 AI  
 AJ  
 AK  
 AL  
 AM  
 AN  
 AO  
 AP  
 AQ  
 AR  
 AS  
 AT  
 AU  
 AV  
 AW  
 AX  
 AY  
 AZ  
 BA  
 BB  
 BC  
 BD  
 BE  
 BF  
 BG  
 BH  
 BI  
 BJ  
 BK  
 BL  
 BM  
 BN  
 BO  
 BP  
 BQ  
 BR  
 BS  
 BT  
 BU  
 BV  
 BW  
 BX  
 BY  
 BZ  
 CA  
 CB  
 CC  
 CD  
 CE  
 CF  
 CG  
 CH  
 CI  
 CJ  
 CK  
 CL  
 CM  
 CN  
 CO  
 CP  
 CQ  
 CR  
 CS  
 CT  
 CU  
 CV  
 CW  
 CX  
 CY  
 CZ  
 DA  
 DB  
 DC  
 DD  
 DE  
 DF  
 DG  
 DH  
 DI  
 DJ  
 DK  
 DL  
 DM  
 DN  
 DO  
 DP  
 DQ  
 DR  
 DS  
 DT  
 DU  
 DV  
 DW  
 DX  
 DY  
 DZ  
 EA  
 EB  
 EC  
 ED  
 EE  
 EF  
 EG  
 EH  
 EI  
 EJ  
 EK  
 EL  
 EM  
 EN  
 EO  
 EP  
 EQ  
 ER  
 ES  
 ET  
 EU  
 EV  
 EW  
 EX  
 EY  
 EZ  
 FA  
 FB  
 FC  
 FD  
 FE  
 FF  
 FG  
 FH  
 FI  
 FJ  
 FK  
 FL  
 FM  
 FN  
 FO  
 FP  
 FQ  
 FR  
 FS  
 FT  
 FU  
 FV  
 FW  
 FX  
 FY  
 FZ  
 GA  
 GB  
 GC  
 GD  
 GE  
 GF  
 GG  
 GH  
 GI  
 GJ  
 GK  
 GL  
 GM  
 GN  
 GO  
 GP  
 GQ  
 GR  
 GS  
 GT  
 GU  
 GV  
 GW  
 GX  
 GY  
 GZ  
 HA  
 HB  
 HC  
 HD  
 HE  
 HF  
 HG  
 HH  
 HI  
 HJ  
 HK  
 HL  
 HM  
 HN  
 HO  
 HP  
 HQ  
 HR  
 HS  
 HT  
 HU  
 HV  
 HW  
 HX  
 HY  
 HZ  
 IA  
 IB  
 IC  
 ID  
 IE  
 IF  
 IG  
 IH  
 II  
 IJ  
 IK  
 IL  
 IM  
 IN  
 IO  
 IP  
 IQ  
 IR  
 IS  
 IT  
 IU  
 IV  
 IW  
 IX  
 IY  
 IZ  
 JA  
 JB  
 JC  
 JD  
 JE  
 JF  
 JG  
 JH  
 JI  
 JJ  
 JK  
 JL  
 JM  
 JN  
 JO  
 JP  
 JQ  
 JR  
 JS  
 JT  
 JU  
 JV  
 JW  
 JX  
 JY  
 JZ  
 KA  
 KB  
 KC  
 KD  
 KE  
 KF  
 KG  
 KH  
 KI  
 KJ  
 KK  
 KL  
 KM  
 KN  
 KO  
 KP  
 KQ  
 KR  
 KS  
 KT  
 KU  
 KV  
 KW  
 KX  
 KY  
 KZ  
 LA  
 LB  
 LC  
 LD  
 LE  
 LF  
 LG  
 LH  
 LI  
 LJ  
 LK  
 LL  
 LM  
 LN  
 LO  
 LP  
 LQ  
 LR  
 LS  
 LT  
 LU  
 LV  
 LW  
 LX  
 LY  
 LZ  
 MA  
 MB  
 MC  
 MD  
 ME  
 MF  
 MG  
 MH  
 MI  
 MJ  
 MK  
 ML  
 MM  
 MN  
 MO  
 MP  
 MQ  
 MR  
 MS  
 MT  
 MU  
 MV  
 MW  
 MX  
 MY  
 MZ  
 NA  
 NB  
 NC  
 ND  
 NE  
 NF  
 NG  
 NH  
 NI  
 NJ  
 NK  
 NL  
 NM  
 NN  
 NO  
 NP  
 NQ  
 NR  
 NS  
 NT  
 NU  
 NV  
 NW  
 NX  
 NY  
 NZ  
 OA  
 OB  
 OC  
 OD  
 OE  
 OF  
 OG  
 OH  
 OI  
 OJ  
 OK  
 OL  
 OM  
 ON  
 OO  
 OP  
 OQ  
 OR  
 OS  
 OT  
 OU  
 OV  
 OW  
 OX  
 OY  
 OZ  
 PA  
 PB  
 PC  
 PD  
 PE  
 PF  
 PG  
 PH  
 PI  
 PJ  
 PK  
 PL  
 PM  
 PN  
 PO  
 PP  
 PQ  
 PR  
 PS  
 PT  
 PU  
 PV  
 PW  
 PX  
 PY  
 PZ  
 QA  
 QB  
 QC  
 QD  
 QE  
 QF  
 QG  
 QH  
 QI  
 QJ  
 QK  
 QL  
 QM  
 QN  
 QO  
 QP  
 QQ  
 QR  
 QS  
 QT  
 QU  
 QV  
 QW  
 QX  
 QY  
 QZ  
 RA  
 RB  
 RC  
 RD  
 RE  
 RF  
 RG  
 RH  
 RI  
 RJ  
 RK  
 RL  
 RM  
 RN  
 RO  
 RP  
 RQ  
 RR  
 RS  
 RT  
 RU  
 RV  
 RW  
 RX  
 RY  
 RZ  
 SA  
 SB  
 SC  
 SD  
 SE  
 SF  
 SG  
 SH  
 SI  
 SJ  
 SK  
 SL  
 SM  
 SN  
 SO  
 SP  
 SQ  
 SR  
 SS  
 ST  
 SU  
 SV  
 SW  
 SX  
 SY  
 SZ  
 TA  
 TB  
 TC  
 TD  
 TE  
 TF  
 TG  
 TH  
 TI  
 TJ  
 TK  
 TL  
 TM  
 TN  
 TO  
 TP  
 TQ  
 TR  
 TS  
 TT  
 TU  
 TV  
 TW  
 TX  
 TY  
 TZ  
 UA  
 UB  
 UC  
 UD  
 UE  
 UF  
 UG  
 UH  
 UI  
 UJ  
 UK  
 UL  
 UM  
 UN  
 UO  
 UP  
 UQ  
 UR  
 US  
 UT  
 UY  
 UZ  
 VA  
 VB  
 VC  
 VD  
 VE  
 VF  
 VG  
 VH  
 VI  
 VJ  
 VK  
 VL  
 VM  
 VN  
 VO  
 VP  
 VQ  
 VR  
 VS  
 VT  
 VY  
 VZ  
 WA  
 WB  
 WC  
 WD  
 WE  
 WF  
 WG  
 WH  
 WI  
 WJ  
 WK  
 WL  
 WM  
 WN  
 WO  
 WP  
 WQ  
 WR  
 WS  
 WT  
 WY  
 WZ  
 XA  
 XB  
 XC  
 XD  
 XE  
 XF  
 XG  
 XH  
 XI  
 XJ  
 XK  
 XL  
 XM  
 XN  
 XO  
 XP  
 XQ  
 XR  
 XS  
 XT  
 XY  
 XZ  
 YA  
 YB  
 YC  
 YD  
 YE  
 YF  
 YG  
 YH  
 YI  
 YJ  
 YK  
 YL  
 YM  
 YN  
 YO  
 YP  
 YQ  
 YR  
 YS  
 YT  
 YZ  
 ZA  
 ZB  
 ZC  
 ZD  
 ZE  
 ZF  
 ZG  
 ZH  
 ZI  
 ZJ  
 ZK  
 ZL  
 ZM  
 ZN  
 ZO  
 ZP  
 ZQ  
 ZR  
 ZS  
 ZT  
 ZY  
 ZZ

Atraumatische Magen- und Darmklemmen  
 Non-traumatic Stomach and Intestinal Clamp Forceps  
 Pinzas-clamps estomacales e intestinales Atrauma  
 Pincas-clamps stomacales et pour l'intestin Atrauma  
 Pinze stomacali e intestinali Atrauma



**BAINBRIDGE**

KD 234/15	15,0 cm/6"	KD 235/15
KD 234/18	18,0 cm/7"	KD 235/18



**DOYEN**

KD 240/16	16,0 cm/6 <sup>1</sup> / <sub>4</sub> "	KD 241/16
KD 240/18	18,0 cm/7"	KD 241/18
KD 240/21	21,0 cm/8 <sup>1</sup> / <sub>4</sub> "	KD 241/21
KD 240/23	23,0 cm/9"	KD 241/23

Atraumatische Magen- und Darmklemmen  
 Non-traumatic Stomach and Intestinal Clamp Forceps  
 Pinzas-clamps estomacales e intestinales Atrauma  
 Pincas-clamps stomacales et pour l'intestin Atrauma  
 Pinze stomacali e intestinali Atrauma



**KOCHER**

KD 250/22	22,0 cm/8 <sup>3</sup> / <sub>4</sub> "	KD 251/22
KD 250/25	25,0 cm/10"	KD 251/25
KD 250/28	28,0 cm/11"	KD 251/28

AA  
AB  
AC  
AD  
AE  
AF  
AK  
AL  
AM  
AO  
AP  
AR  
KA  
KU  
KY

**KD**

Atraumatische Magen- und Darmklemmen  
 Non-traumatic Stomach and Intestinal Clamp Forceps  
 Pinzas-clamps estomacales e intestinales Atrauma  
 Pincas-clamps stomacales et pour l'intestin Atrauma  
 Pinze stomacali e intestinali Atrauma

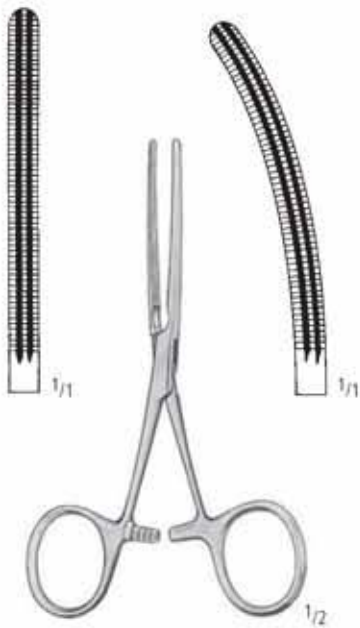

**BABY KOCHER**  
 KD 252/13    13,0 cm/5"    KD 253/13

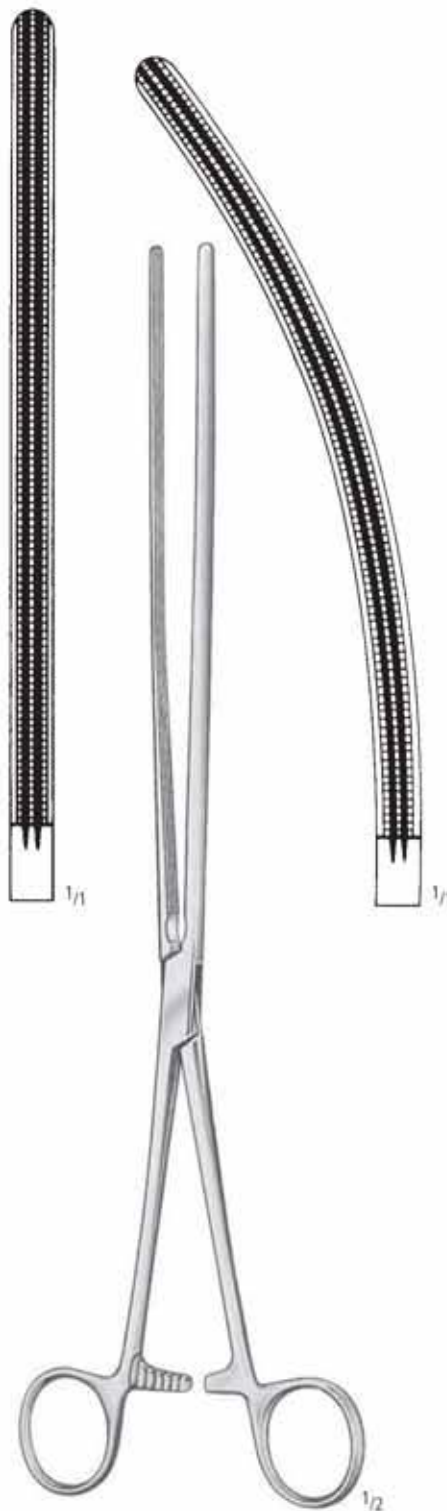

**MAYO ROBSON**  
 KD 256/25    25,0 cm/10"    KD 257/25

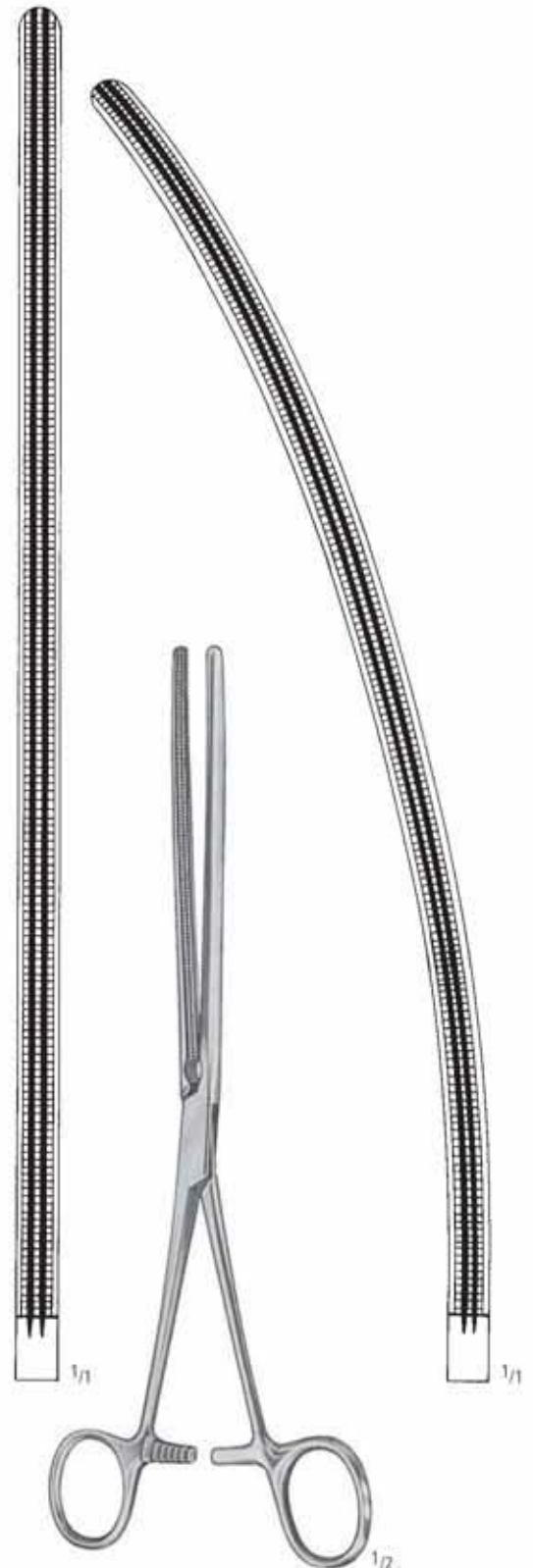

**SCUDDER**  
 KD 258/33    33,0 cm/13"    KD 259/33



Atraumatische Magen- und Darmklemmen  
 Non-traumatic Stomach and Intestinal Clamp Forceps  
 Pinzas-clamps estomacales e intestinales Atrauma  
 Pincas-clamps stomacales et pour l'intestin Atrauma  
 Pinze stomacali e intestinali Atrauma

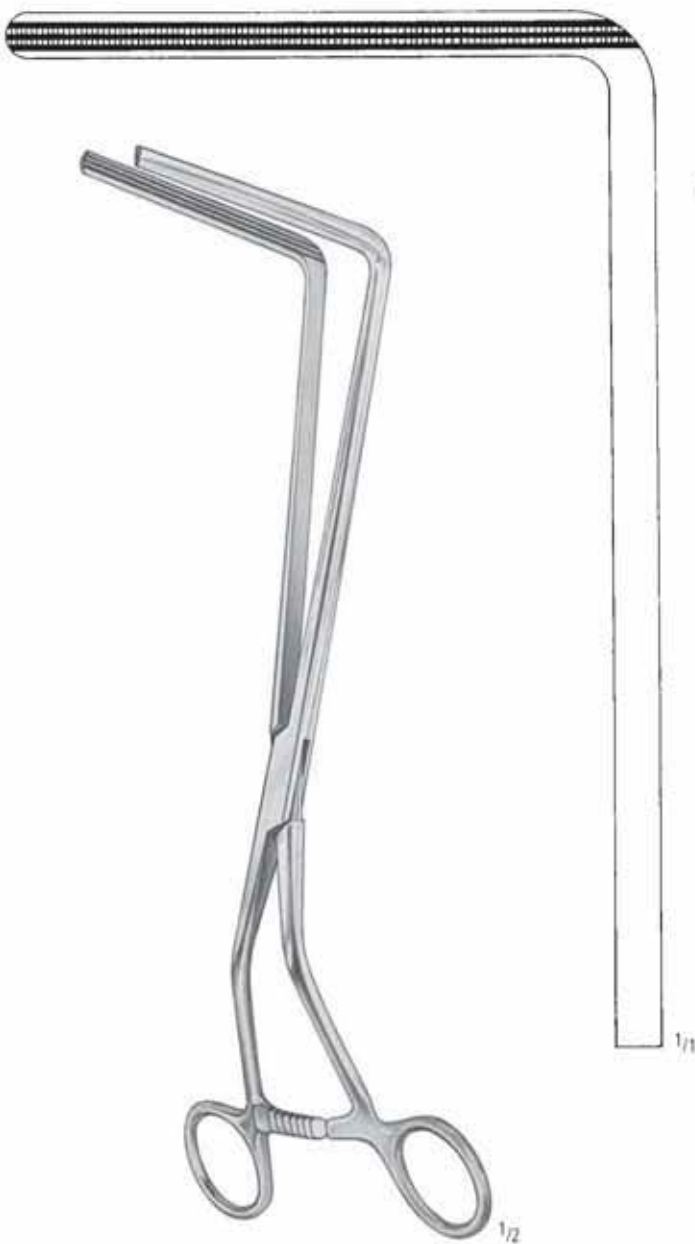

**RESANO**  
 KD 260/30  
 30,0 cm/12"



**FEHLAND**  
 KD 270/24  
 24,0 cm/9 1/2"

AA  
 AB  
 AC  
 AD  
 AE  
 AF  
 AK  
 AL  
 AM  
 AO  
 AP  
 AR  
 KA  
**KD**  
 KU  
 KY

Anastomosenklemmen  
 Anastomosis Forceps  
 Pinzas para anastomosis  
 Pincès à anastomose  
 Pinze per anastomosi

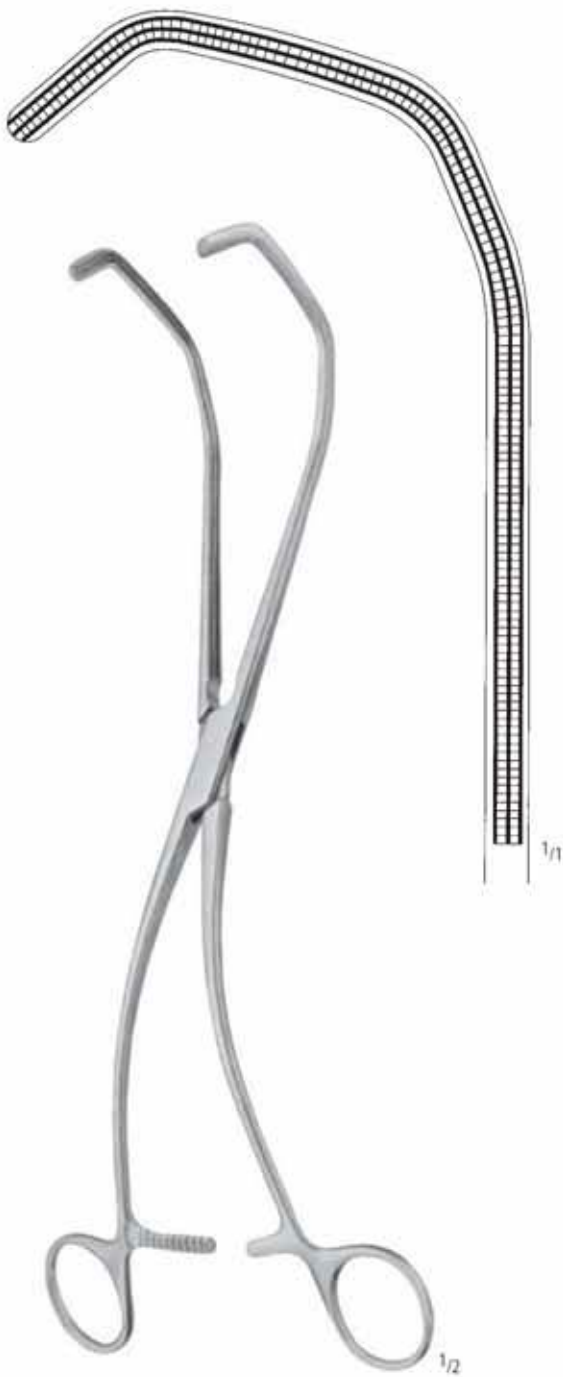

**KERSTING**  
 KD 273/30  
 30,0 cm/12"



**DICK**

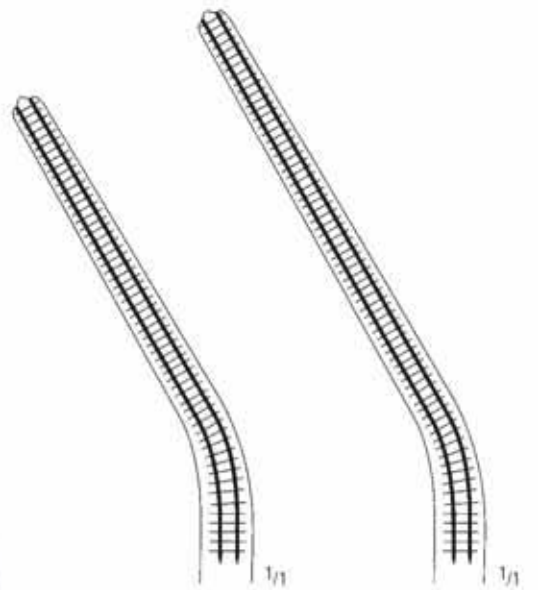

**KD 275/01**  
 25,5 cm/10"

**KD 275/02**  
 26,5 cm/10½"

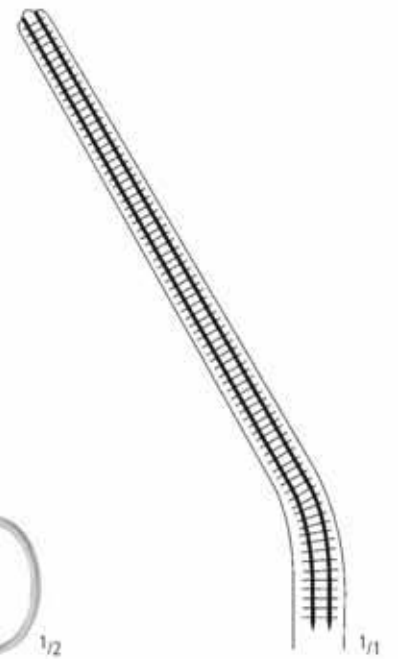

**KD 275/03**  
 27,5 cm/10¾"



Anastomosenklemmen  
 Anastomosis Forceps  
 Pinzas para anastomosis  
 Pinces à anastomose  
 Pinze per anastomosi



**LLOYD-DAVIS**  
 KD 277/32  
 31,5 cm/12<sup>1</sup>/<sub>2</sub>"

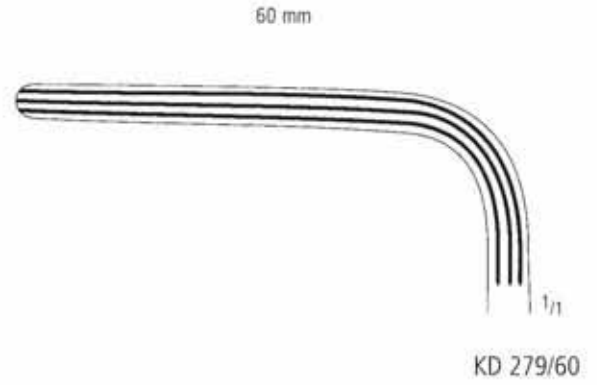

AA  
 AB  
 AC  
 AD  
 AE  
 AF  
 AK  
 AL  
 AM  
 AO  
 AP  
 AR  
 KA  
**KD**  
 KU  
 KY

Darm- und Magenquetschklemmen  
 Intestinal and Stomach Crushing Clamps  
 Pinzas-clamps intestinales y estomacales  
 Pincas-clamps et Ecraseurs pour l'intestin et l'estomac  
 Pinze e Schiacciatori per intestino e stomaco

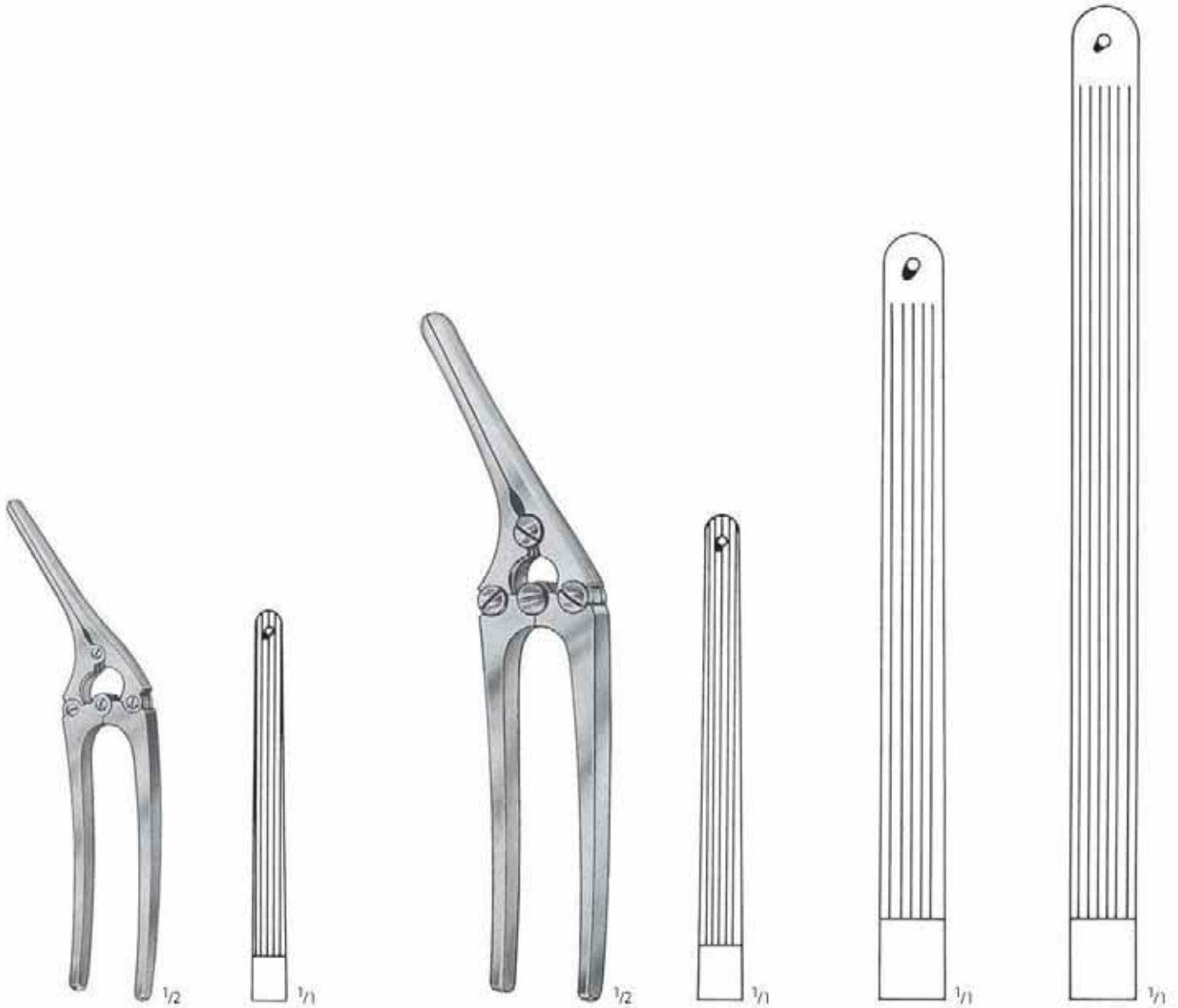

**PAYR-BABY**  
 15,0 cm/6"

ohne Stift  
 without pin  
 sin espiga  
 sans cheville  
 senza perno

KD 310/15

mit Stift  
 with pin  
 con espiga  
 avec cheville  
 con perno

KD 312/15

**PAYR**

21,0 cm/8<sup>1</sup>/<sub>4</sub>"

ohne Stift  
 without pin  
 sin espiga  
 sans cheville  
 senza perno

KD 314/21

mit Stift  
 with pin  
 con espiga  
 avec cheville  
 con perno

KD 316/21

29,0 cm/11<sup>1</sup>/<sub>2</sub>"

KD 318/29

KD 320/29

35,0 cm/14"

KD 322/35

KD 324/35

Magenklemmen  
 Stomach Clamp Forceps  
 Pinzas-clamps estomacales  
 Pincas-clamps stomacales  
 Pinze stomacali

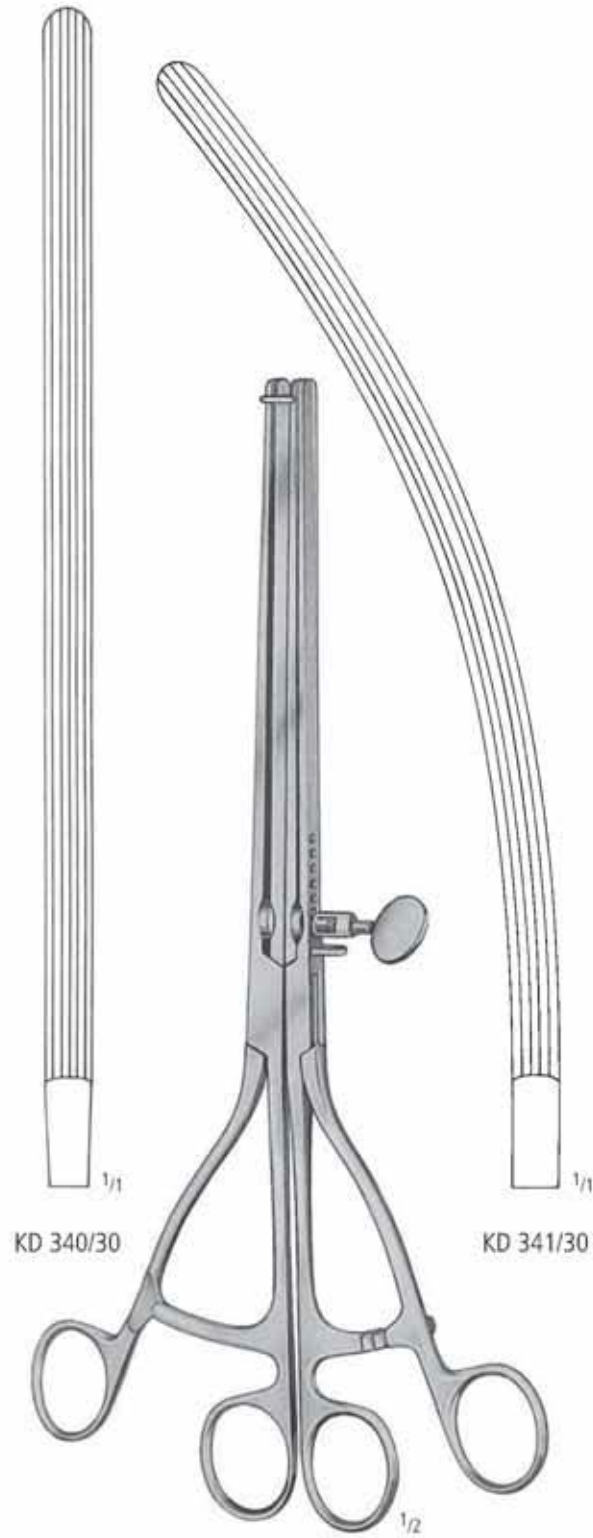

**LANE**  
 30,0 cm/12"

AA  
 AB  
 AC  
 AD  
 AE  
 AF  
 AK  
 AL  
 AM  
 AO  
 AP  
 AR  
 KA  
 KU  
 KY

**KD**

Darmklemmen, Anastomosenklemmen  
 Intestinal and Anastomosis Clamp Forceps  
 Pinzas-clamps intestinales y para anastomosis  
 Pinces-clamps intestinales et à anastomose  
 Pinze intestinali e per anastomosi



Maullänge  
 jaw length  
 largo de boca  
 longueur des mors  
 lunghezza del morso

5,0 cm/2"	KD 350/05
7,0 cm/2 <sup>3</sup> / <sub>4</sub> "	KD 350/07
10,0 cm/4"	KD 350/10

**DE MARTEL-WOLFSON**

Satz zu 3 Anastomosenklemmen  
 Set of 3 anastomosis clamps  
 Juego de 3 clamps para anastomosis  
 Jeu de 3 pinces-clamps à anastomose  
 Serie di 3 pinze per anastomosi

Darmklemmen, Anastomosenklemmen  
 Intestinal and Anastomosis Clamp forceps  
 Pinzas-clamps intestinales y para anastomosis  
 Pincas-damps intestinales et à anastomose  
 Pinze intestinali e per anastomosi



**DE MARTEL-WOLFSON**  
 KD 355/26  
 26,0 cm/10<sup>1</sup>/<sub>2</sub>"



KD 370/08  
 8,5 cm/3<sup>1</sup>/<sub>3</sub>"



**DE MARTEL-WOLFSON**  
 KD 370/23  
 23,0 cm/9"

AA  
 AB  
 AC  
 AD  
 AE  
 AF  
 AK  
 AL  
 AM  
 AO  
 AP  
 AR  
 KA  
**KD**  
 KU  
 KY

**KD** MASTDARM RECTUM RECTO RECTUM RETTO

Mastdarm - Spekula  
 Rectal Specula  
 Espécúlos rectales  
 Spéculums rectaux  
 Specoli rettali



**CZERNY**  
 KD 618/22  
 22,0 cm/8<sup>3</sup>/<sub>4</sub>"



**SAWYER**  
 KD 619/01 64 x 22 mm 270 mm  
 KD 619/02 75 x 30 mm 280 mm  
 KD 619/03 89 x 38 mm 280 mm



**SIMS**  
 KD 622/15  
 15,0 cm/6"



**SIMS**  
 KD 624/15  
 15,0 cm/6"



MASTDARM RECTUM RECTO RECTUM RETTO

Mastdarm - Spekula  
 Rectal Specula  
 Espéculos rectales  
 Spéculums rectaux  
 Specoli rettali



**SCHULZE-BERGMANN**  
 22,0 cm/8<sup>3</sup>/<sub>4</sub>"

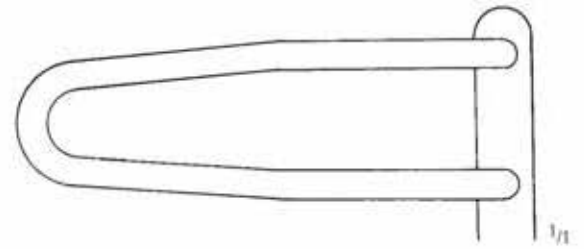

KD 630/06  
 60 mm

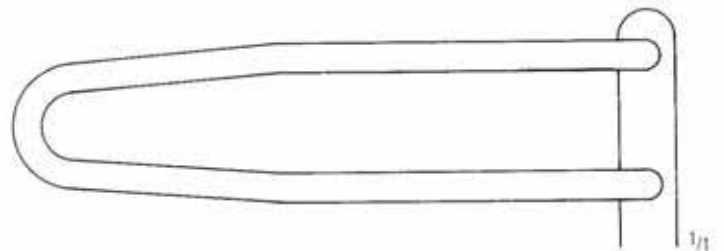

KD 630/08  
 80 mm

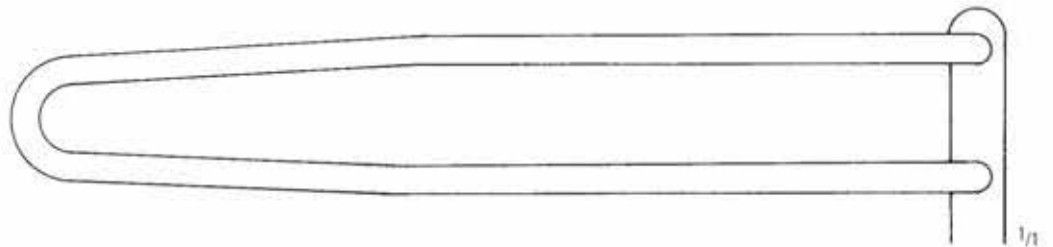

KD 630/12  
 125 mm

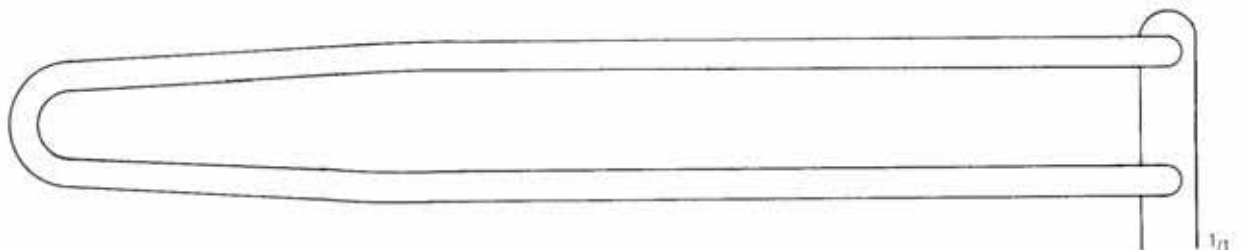

KD 630/15  
 150 mm

AA  
 AB  
 AC  
 AD  
 AE  
 AF  
 AK  
 AL  
 AM  
 AO  
 AP  
 AR  
 KA  
**KD**  
 KU  
 KY

**KD** MASTDARM RECTUM RECTO RECTUM RETTO

Mastdarm - Spekula  
 Rectal Specula  
 Espécúlos rectales  
 Spéculums rectaux  
 Specoli rettali



1/2

**PRATT**  
 KD 640/21  
 21,5 cm/8 1/2"  
 85 x 25 mm



1/2

**MATHIEU**  
 KD 650/19  
 19,5 cm/7 3/4"  
 90 x 15 mm



1/2

**SMITH-BUIE**  
 KD 660/15  
 15,0 cm/6"  
 75 x 23 mm

MASTDARM RECTUM RECTO RECTUM RETTO

Sphinkteroskope, Anuskope, Proktoskope  
 Sphincteroscopes, Anoscopes, Proctoscopes  
 Esfinteroscopios, Anoscopios, Proctoscopios  
 Sphinctérosopes, Anusopes, Proctosopes  
 Sfinteroscopi, Anoscopi, Protoscopi



**ROSCHKE**  
 KD 662/01  
 Ø 15/30 x 70 mm



**ROSCHKE**  
 KD 662/02  
 Ø 15/30 x 70 mm

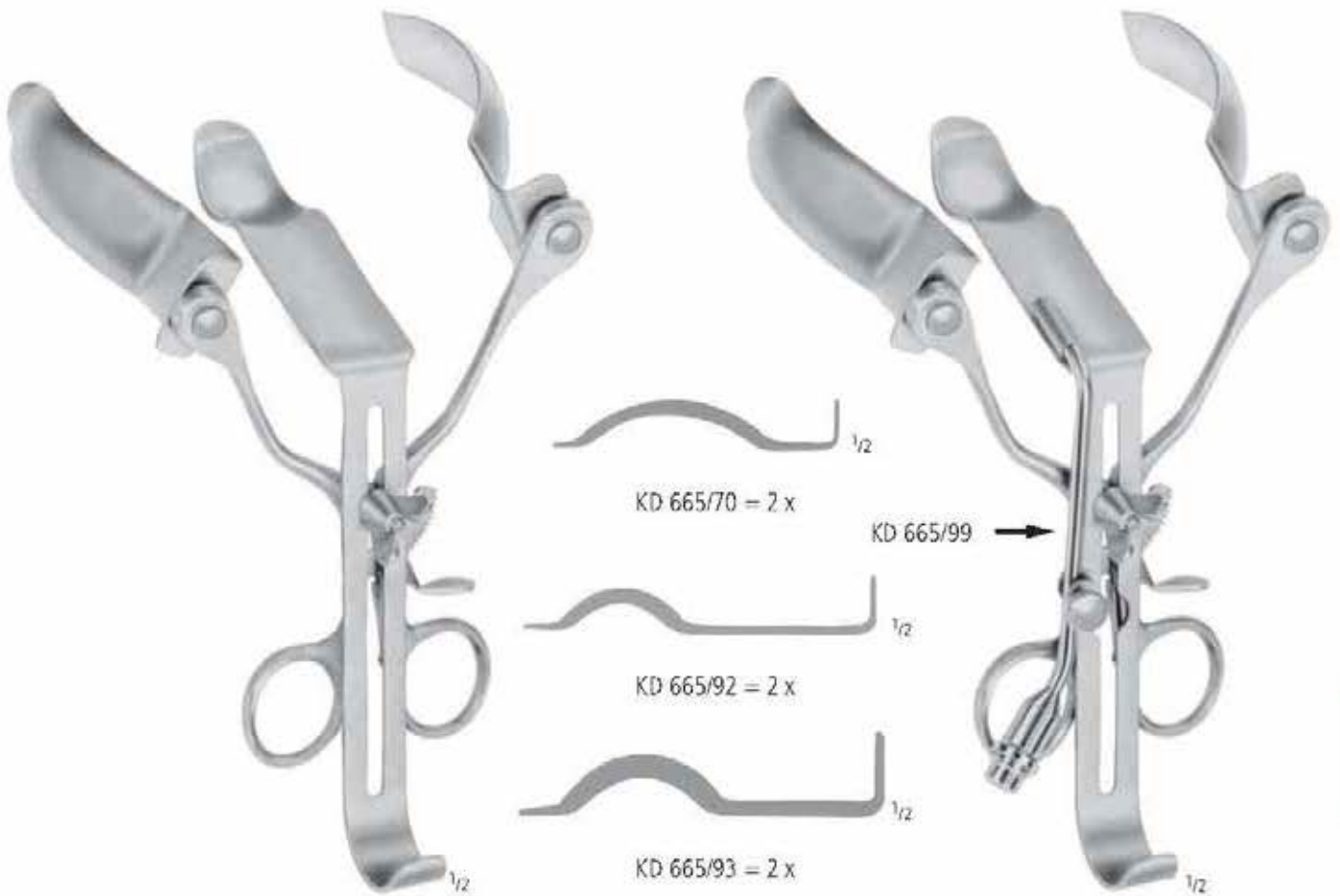

**ALAN PARKS**  
 KD 665/01

komplett mit 2 Paar Valven  
 complete with 2 pair of valves

**ALAN PARKS**  
 KD 665/02

AA  
 AB  
 AC  
 AD  
 AE  
 AF  
 AK  
 AL  
 AM  
 AO  
 AP  
 AR  
 KA  
 KD  
 KU  
 KY

**KD** MASTDARM RECTUM RECTO RECTUM RETTO

Sphinkterskope, Anuskope, Proktoskope  
 Sphincteroscopes, Anoscopes, Proctoscopes  
 Esfinteroscopios, Anoscopios, Proctoscopios  
 Sphinctéroscofes, Anoscopos, Proctoscopos  
 Sfinteroscopi, Anoscopi, Proctoscopi



**IVES-FANSLER**  
 KD 668/22  
 Ø 22 mm



**IVES-FANSLER**  
 KD 669/22  
 Ø 22 mm

← KD 669/99

MASTDARM RECTUM RECTO RECTUM RETTO

Sphinkterskope, Anuskope, Proktoskope  
 Sphincteroscopes, Anoscopes, Proctoscopes  
 Esfinteroscopios, Anoscopios, Proctoscopios  
 Sphinctérosopes, Anusopes, Proctoscopes  
 Sfinteroscopi, Anoscopi, Proctoscopi



**HIRSCHMANN**

- KD 670/01 = 16 mm Ø x 65 mm
- KD 670/02 = 19 mm Ø x 65 mm
- KD 670/03 = 22 mm Ø x 65 mm
- KD 670/04 = 22 mm Ø x 125 mm



**HIRSCHMANN**

- KD 671/01 = 16 mm Ø x 60 mm
- KD 671/02 = 19 mm Ø x 70 mm
- KD 671/03 = 24 mm Ø x 90 mm
- KD 671/04 = 24 mm Ø x 130 mm

AA  
AB  
AC  
AD  
AE  
AF  
AK  
AL  
AM  
AO  
AP  
AR  
KA  
KU  
KY

**KD**

**KD** MASTDARM RECTUM RECTO RECTUM RETTO

Sphinkteroskope, Anuskope, Proktoskope  
 Sphincteroscopes, Anoscopes, Proctoscopes  
 Esfinteroscopios, Anoscopios, Proctoscopios  
 Sphinctéroscofes, Anoscopes, Proctoscopes  
 Sfinteroscopi, Anoscopi, Proctoscopi



**BENSAUDE**

KD 675/19 = 19 mm Ø x 70 mm

KD 675/22 = 22 mm Ø x 70 mm



**KELLY**

KD 680/05 = 22 mm Ø x 50 mm

KD 680/10 = 22 mm Ø x 100 mm

KD 680/14 = 22 mm Ø x 140 mm

KD 680/20 = 22 mm Ø x 200 mm



MASTDARM RECTUM RECTO RECTUM RETTO

Sphinkterskope, Anuskope, Proktoskope  
 Sphincteroscopes, Anoscopes, Proctoscopes  
 Esfinteroscopios, Anoscopios, Proctoscopios  
 Sphinctérosopes, Anusopes, Proctoscopes  
 Sfinteroscopi, Anoscopi, Proctoscopi



**KELLY**

KD 685/21 = 21 mm Ø x 50 mm

KD 685/27 = 27 mm Ø x 50 mm



**MORGAN**

KD 690/01 = 17 mm Ø x 65 mm

KD 690/02 = 17 mm Ø x 80 mm

KD 690/03 = 20 mm Ø x 65 mm

KD 690/04 = 20 mm Ø x 80 mm

KD 690/05 = 24 mm Ø x 65 mm

KD 690/06 = 24 mm Ø x 80 mm



**MORGAN**

KD 690/99

**KALTLICHT / FIBRE OPTIC**

AA  
AB  
AC  
AD  
AE  
AF  
AK  
AL  
AM  
AO  
AP  
AR  
KA  
KD  
KU  
KY

**KD** MASTDARM RECTUM RECTO RECTUM RETTO

Anuskope, Proktoskope  
 Anoscopes, Proctoscopes  
 Anoscopios, Proctoscopios  
 Anuscopes, Proctoscopes  
 Anoscopi, Proctoscopi

**BLOND**

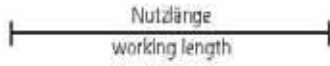

KD 700/01  
 18/24 mm Ø x 75 mm



KD 700/02  
 18/24 mm Ø x 75 mm



KD 700/03  
 15/23 mm Ø x 75 mm



KD 700/04  
 18/25 mm Ø x 105 mm



KD 702/01  
 26 mm Ø x 60 mm



KD 702/02  
 21 mm Ø x 80 mm



KD 702/03  
 24 mm Ø x 80 mm



KD 702/04  
 21 mm Ø x 120 mm

MASTDARM RECTUM RECTO RECTUM RETTO

Anuskope, Proktoskope  
Anoscopes, Proctoscopes  
Anoscopios, Proctoscopios  
Anuscopes, Proctoscopes  
Anoscopi, Proctoscopi



KD 705/01



KD 705/02 = KD 705/80  
KD 705/90  
KD 705/99

GRIFFE FÜR KD 700/01 - KD 702/04  
HANDLES FOR KD 700/01 - KD 702/04



**BLOND**  
KD 707/01 = KD 705/01  
KD 700/01



**BLOND**  
KD 707/02 = KD 705/02  
KD 700/01

AA  
AB  
AC  
AD  
AE  
AF  
AK  
AL  
AM  
AO  
AP  
AR  
KA  
KD  
KU  
KY

Rektoskope  
 Rectoscopes  
 Rectoscopios  
 Rektoskopes  
 Rectoscopi



**KALTLICHT KOPF**  
**F/O HEAD**  
 KD 715/01



**KALTLICHT**  
**FIBRE OPTIC**  
 KD 715/02

**GRIFFE FÜR NACHFOLGENDE TUBEN**  
**HANDLES FOR TUBES SHOWN NEXT PAGES**



**KD 717/01**  
**KOPF für**            **KD 717/02**  
**HEAD for**         **KD 717/02**



**WARMLICHT**  
**BATTERY**  
 KD 717/02

MASTDARM RECTUM RECTO RECTUM RETTO

Rektoskope  
 Rectoscopes  
 Rectoscopios  
 Rektoskopes  
 Rectoscopi



**DIAGNOSTIC**  
 KD 719/15 = 15 mm Ø x 200 mm



**PROKTOSKOP**  
 KD 720/00 = 18/24 mm Ø x 75 mm



**ANUSKOP**  
 KD 722/00 = 21 mm Ø x 80 mm



**KALTLICHT / FIBRE OPTIC**  
 KD 722/99  
 62 mm

AA  
 AB  
 AC  
 AD  
 AE  
 AF  
 AK  
 AL  
 AM  
 AN  
 AO  
 AP  
 AR  
 KA  
 KU  
 KY

**KD**

**KD** MASTDARM RECTUM RECTO RECTUM RETTO

Rektoskope  
Rectoscopes  
Rectoscopios  
Rektoskopes  
Rectoscopi



KD 724/20 = 20 mm Ø x 200 mm  
KD 724/25 = 20 mm Ø x 250 mm  
KD 724/30 = 20 mm Ø x 300 mm



KD 725/20 = 200 mm  
KD 725/25 = 250 mm  
KD 725/30 = 300 mm



**KALT LICHT  
FIBRE OPTIC**

KD 728/20 = 200 mm  
KD 728/25 = 250 mm  
KD 728/30 = 300 mm

**WARM LICHT  
CONVENTIONAL ILLUMINATION**

KD 729/20 = 200 mm  
KD 729/25 = 250 mm  
KD 729/30 = 300 mm

KD 729/99



**VERSCHLUSSDECKEL  
COVER CAP**  
KD 731/00



**SCHWENKLUPE  
SWIVEL LENS**  
KD 731/01



**TELESKOPIK  
TELESCOPE**  
KD 731/02



**DOPPELGEBLÄSE MIT L/L  
DOUBLEBLOWER WITH L/L**  
KD 731/04



## MASTDARM RECTUM RECTO RECTUM RETTO

Rektoskope  
 Rectoscopes  
 Rectoscopios  
 Rektoskopes  
 Rectoscopi



KD 740/00 = KD 715/01  
 KD 731/00  
 KD 731/01  
 KD 715/02  
 KD 724/25  
 KD 725/25  
 KD 728/25  
 KD 720/00  
 KD 722/00  
 KD 722/99  
 KD 731/04

**REKTO - PROKTOSKOPSET MIT F/O - BELEUCHTUNG**

F/O - Rektoskopkopf mit Zweiweghahn, Verschlussdeckel und Schwenklupe, Griff, Rektoskoptubus 250 mm, Ø 20 mm mit Mandrin und F/O Lichtträger, Anuskoptubus 80 mm, mit Mandrin, Proktoskoptubus mit Seitenfenster und kurzem F/O Lichtträger, Doppelgebläse.

**RECTO - PROCTOSCOPE WITH F/O - ILLUMINATION**

F/O - Rectoscope-head with two-way stop-cock, lens cover and swivel lens, handle, Rectoscope-tube 250 mm, Ø 20 mm, with obturator and F/O light-carrier, Anoscope-tube 80 mm with obturator, Proctoscope-tube with lateral window and short F/O light-carrier, double blower.

AA

AB

AC

AD

AE

AF

AK

AL

AM

AO

AP

AR

KA

KD

KU

KY

Rektoskope  
 Rectoscopes  
 Rectoscopios  
 Rektoskopes  
 Rectoscopi

### STRAUSS



KD 741/00 – KD 715/01  
 KD 715/02  
 KD 731/00  
 KD 731/02  
 KD 724/20  
 KD 724/25  
 KD 724/30  
 KD 725/20  
 KD 725/25  
 KD 725/30  
 KD 728/20  
 KD 728/25  
 KD 728/30  
 KD 731/04

#### F/O - REKTOSKOP NACH STRAUSS

F/O - Rektoskopkopf mit Zweifweghahn, Verschlussdeckel und Teleskop-Optik, Griff, je ein Rektoskoptubus in 200 mm, 250 mm und 300 mm, Ø 20 mm, mit Mandrin und F/O Lichtträger, Doppelgebläse.

#### F/O - RECTOSCOPE BY STRAUSS

F/O - Rectoscope-head with two-way stop-cock, lens cover and telescope, handle, 3 Rectoscope-tubes Ø 20 mm, with obturator and F/O light-carrier 200 mm, 250 mm and 300 mm, double blower.

## MASTDARM RECTUM RECTO RECTUM RETTO

Rektoskope  
 Rectoscopes  
 Rectoscopios  
 Rektoskopes  
 Rectoscopti



KD 742/00 – KD 715/01  
 KD 731/00  
 KD 731/02  
 KD 715/02  
 KD 724/30  
 KD 725/30  
 KD 728/30  
 KD 731/04

**KOMPLETTES REKTOSKOPSET MIT F/O - BELEUCHTUNG**

F/O - Rektoskopkopf mit Zweiweghahn, Verschlussdeckel und Teleskop-Optik, Griff, Rektoskoptubus in 300 mm Ø 20 mm, mit Mandrin und F/O Lichtträger, Doppelgebläse.

**COMPLETE RECTOSCOPE WITH F/O - ILLUMINATION**

F/O - Rectoscope-head with two-way stop-cock, lens cover and telescope, handle, Rectoscope-tube 300 mm, Ø 20 mm, with obturator and F/O light-carrier, double blower.

AA

AB

AC

AD

AE

AF

AK

AL

AM

AO

AP

AR

KA

KD

KU

KY

Rektoskope  
 Rectoscopes  
 Rectoscopios  
 Rektoskopes  
 Rectoscopi

**REKTOSKOP MIT KONVENTIONELLER BELEUCHTUNG  
 RECTOSCOPE WITH CONVENTIONAL ILLUMINATION**



KD 743/00 – KD 717/01  
 KD 731/00  
 KD 731/02  
 KD 724/30  
 KD 725/30  
 KD 729/30  
 KD 731/04  
 KD 717/02

**KOMPLETTES REKTOSKOP MIT KONVENTIONELLER BELEUCHTUNG**

Rektoskopkopf mit Zweiweghahn, Verschlussdeckel und Teleskop-Optik, Rektoskoptubus 300 mm, Ø 20 mm, mit Mandrin und Lampenträger, Doppelgebläse, Batteriegriff.

**COMPLETE RECTOSCOPE WITH CONVENTIONAL ILLUMINATION**

Rectoscope-head with two-way stop-cock, lens cover and telescope, Rectoscope-tube 300 mm, Ø 20 mm, with obturator and lamp-carrier, double blower, battery handle.

MASTDARM RECTUM RECTO RECTUM RETTO

Mastdarm - Biopsiezangen  
 Rectal Biopsy Forceps  
 Pinzas saca bocado para biopsia retal  
 Pincas emporte-pièces à biopsie rectale  
 Pinze tagliente per biopsia rettale

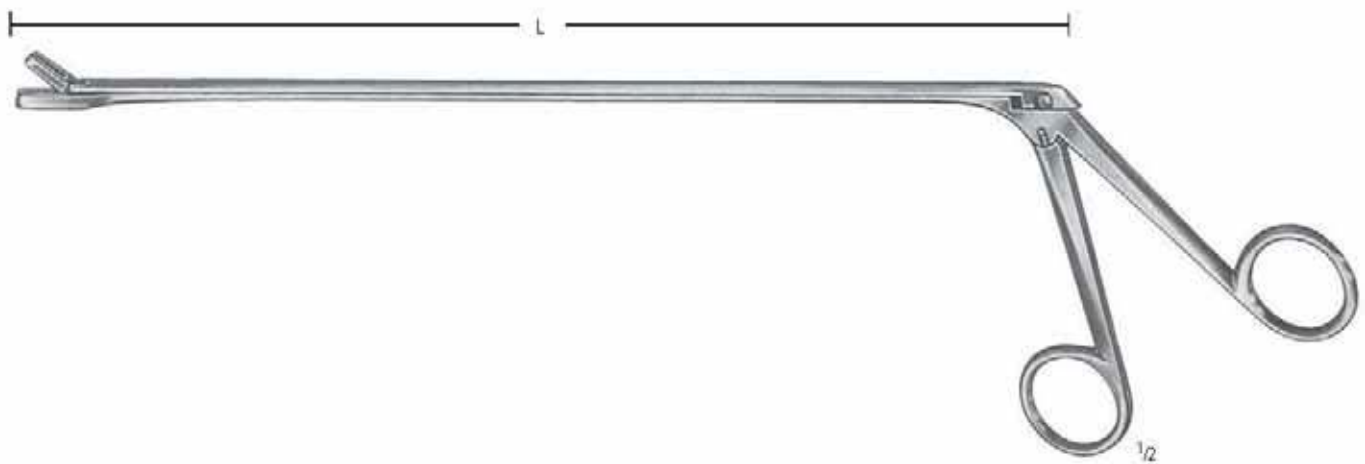

YEOMANN

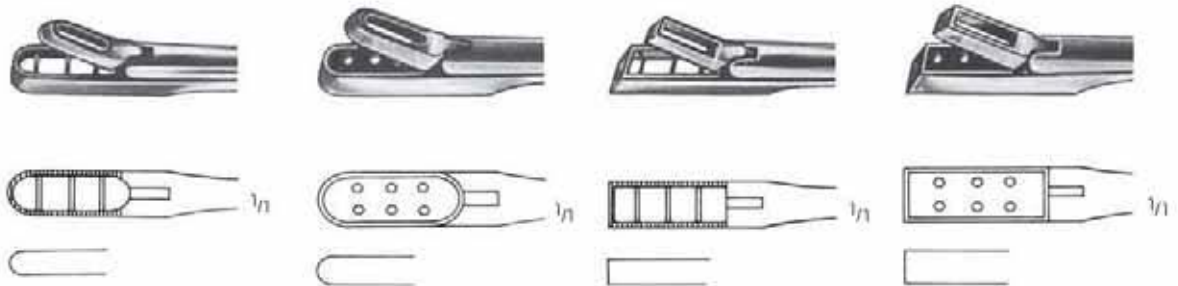

L = 28,0 cm/11"  
 L = 35,0 cm/14"  
 L = 42,0 cm/16 1/2"

Fig.1  
 KD 751/28  
 KD 751/35  
 KD 751/42

Fig. 2  
 KD 752/28  
 KD 752/35  
 KD 752/42

Fig. 3  
 KD 753/28  
 KD 753/35  
 KD 753/42

Fig. 4  
 KD 754/28  
 KD 754/35  
 KD 754/42

AA  
 AB  
 AC  
 AD  
 AE  
 AF  
 AK  
 AL  
 AM  
 AO  
 AP  
 AR  
 KA  
 KU  
 KY

KD

**KD** MASTDARM RECTUM RECTO RECTUM RETTO

Hämorrhoidal-Ligatoren  
 Haemorrhoidal Ligators  
 Ligadores hemorroides  
 Ligateurs hémorroïdes  
 Legatori emorroidali

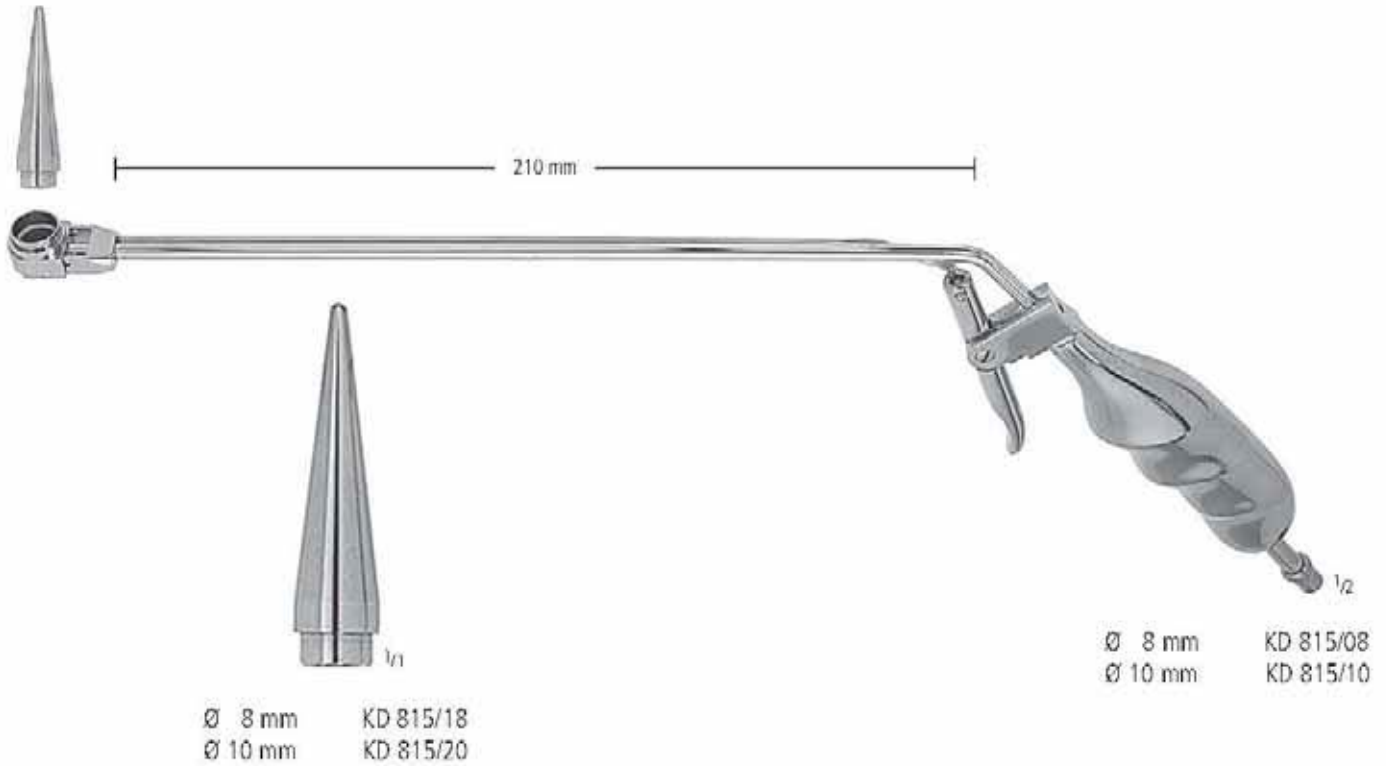



MASTDARM RECTUM RECTO RECTUM RETTO

Hämorrhoidal-Ligatoren  
Haemorrhoidal Ligators  
Ligadores hemorroides  
Ligateurs hémorroïdes  
Legatori emorroidali



**KD 817/00**  
Ligatur-Gummringe, 100 Stück  
O-rings, 100 pieces  
Anillos ligadura, 100 piezas  
Anneaux de caoutchouc, 100 pièces  
Anelli per legature, 100 pezzi



**KD 818/01**  
Ø 10 mm

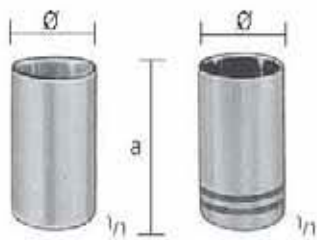

**KD 818/11**  
Ø 10 mm  
a = 11 mm

**KD 818/16**  
Ø 10 mm  
a = 16 mm



**KD 820/01**  
Ø 12 mm



**KD 818/00 =**  
mit  
with  
con  
avec  
con  
**KD 818/01 + KD 818/11**



**MC GIVNEY**  
**KD 820/19**  
19,0 cm/7 1/2"

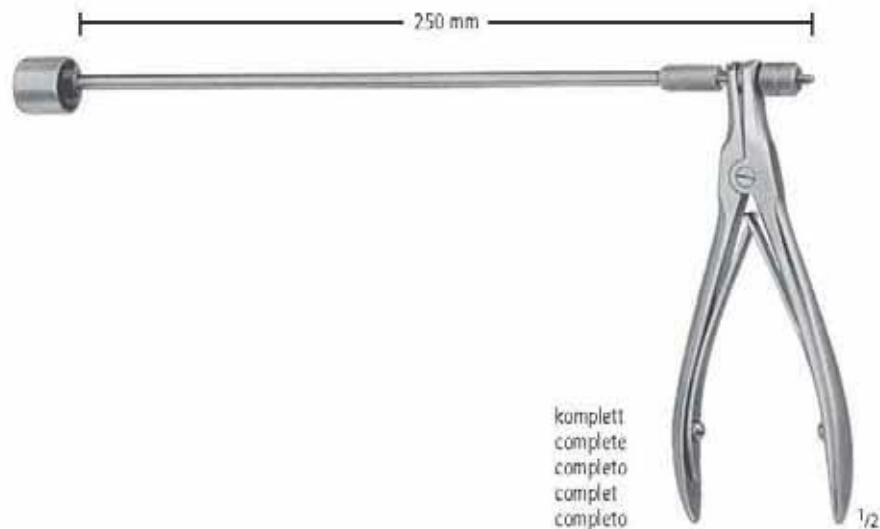

komplett  
complete  
completo  
complet  
completo

**KD 820/00**

AA  
AB  
AC  
AD  
AE  
AF  
AK  
AL  
AM  
AO  
AP  
AR  
KA  
KD  
KU  
KY

**KD** MASTDARM RECTUM RECTO RECTUM RETTO

Hämorrhoidal-Ligatoren  
 Haemorrhoidal Ligators  
 Ligadores hemorroides  
 Ligateurs hémorroïdes  
 Legatori emorroidali



**RUDD**  
 KD 822/00



KD 822/12

---

VERSCHIEDENES  
VARIOUS ITEMS  
DIVERSOS ARTICULOS  
ARTICLES DIVERS  
ARTICOLI DIVERSI

**KU**

**nopa**<sup>®</sup> instruments





KU 210/10  
ca. 100 cc



KU 211/12  
ca. 120 cc



KU 280/12  
110 x 30 mm 1,25 cl



KU 280/50  
Ø = 100 mm



KU 284/10  
Ø = 100 mm



KU 286/05  
45 x 53 mm 0,05 l

AA

AB

AC

AD

AE

AF

AK

AL

AM

AO

AP

AR

KA

KD

KU

KY



Ø x h		
75 x 75 mm	0,3 l	KU 290/03
80 x 85 mm	0,4 l	KU 290/04



Ø x h		
80 x 85 mm	0,4 l	KU 291/04
komplett mit Deckel		
complete with cap		



Ø x h		
60 x 60 mm	0,15 l	KU 295/10
85 x 50 mm	0,25 l	KU 295/11
85 x 85 mm	0,40 l	KU 295/12
85 x 125 mm	0,60 l	KU 295/13
100 x 50 mm	0,35 l	KU 295/14
100 x 100 mm	0,75 l	KU 295/15
120 x 120 mm	1,25 l	KU 295/16
150 x 100 mm	1,75 l	KU 295/17
150 x 150 mm	2,50 l	KU 295/18
200 x 100 mm	3,00 l	KU 295/19
200 x 200 mm	6,00 l	KU 295/20
komplett mit Deckel		
complete with cap		





1/2

Ø x h		
40 x 19 mm	0,05 l	KU 300/04
61 x 30 mm	0,07 l	KU 300/06
80 x 40 mm	0,14 l	KU 300/08
116 x 50 mm	0,35 l	KU 300/11
128 x 55 mm	0,45 l	KU 300/12
147 x 65 mm	0,70 l	KU 300/14



1/2

KU 301/01	= 0,25 l
KU 301/02	= 0,50 l
KU 301/03	= 1,00 l
KU 301/04	= 2,00 l



L = 170 mm	KU 302/17
L = 250 mm	KU 302/25
L = 275 mm	KU 302/27

AA

AB

AC

AD

AE

AF

AK

AL

AM

AO

AP

AR

KA

KD

**KU**

KY



KU 303/65

KU 303/00  
Ø = 65 mm



KU 304/50 = 50 x 25 x 4,5 mm  
KU 304/65 = 65 x 42 x 8,0 mm  
KU 304/75 = 75 x 25 x 4,5 mm



KU 306/15 = 150 x 95 x 13 mm



l x b x h	
230 x 155 x 30 mm	KU 307/23
300 x 175 x 30 mm	KU 307/30
300 x 175 x 40 mm	KU 308/30
350 x 240 x 36 mm	KU 308/35
400 x 300 x 50 mm	KU 308/50



l x b x h	
210 x 160 x 10 mm	KU 309/21
240 x 180 x 10 mm	KU 309/24
310 x 150 x 10 mm	KU 309/31
310 x 210 x 10 mm	KU 310/31
350 x 240 x 10 mm	KU 310/35
400 x 270 x 20 mm	KU 310/40
420 x 280 x 10 mm	KU 310/42

AA

AB

AC

AD

AE

AF

AK

AL

AM

AO

AP

AR

KA

KD

**KU**

KY



Ø x h	l	
165 x 60 mm	0,75	KU 311/16
175 x 70 mm	1,00	KU 311/17
220 x 80 mm	2,00	KU 311/22
225 x 90 mm	2,50	KU 311/23
240 x 110 mm	3,00	KU 311/24
275 x 115 mm	4,50	KU 311/27
290 x 125 mm	6,00	KU 311/29
310 x 120 mm	6,00	KU 311/31
345 x 125 mm	8,50	KU 311/34
380 x 130 mm	11,00	KU 311/38



l x b x h	
16,5 x 9,0 x 3,5 cm	KU 312/16
20,0 x 10,0 x 5,0 cm	KU 312/20
22,0 x 15,0 x 5,0 cm	KU 312/22
26,0 x 15,0 x 5,0 cm	KU 312/26
30,5 x 20,5 x 5,0 cm	KU 312/30
30,0 x 15,0 x 5,0 cm	KU 312/31
50,0 x 20,0 x 10,0 cm	KU 312/50
50,0 x 20,0 x 12,0 cm	KU 312/51

Deckel ohne Knopf  
Lid without knob  
Tapa sin botón  
Couvercle sans bouton  
Coperchio senza pomolo

l x b x h	
16,5 x 9,0 x 3,5 cm	KU 313/16
20,0 x 10,0 x 5,0 cm	KU 313/20
22,0 x 15,0 x 5,0 cm	KU 313/22
26,0 x 15,0 x 5,0 cm	KU 313/26
30,5 x 20,5 x 5,0 cm	KU 313/30
30,0 x 15,0 x 5,0 cm	KU 313/31
50,0 x 20,0 x 10,0 cm	KU 313/50
50,0 x 20,0 x 12,0 cm	KU 313/51



Ø x h	
30 x 90 mm	KU 314/09
50 x 100 mm	KU 314/10
50 x 130 mm	KU 314/13
50 x 175 mm	KU 314/17
75 x 100 mm	KU 315/10
75 x 130 mm	KU 315/13
75 x 175 mm	KU 315/17



KU 316/10  
350 x 270 x 100 mm



Ø 235 mm KU 316/23  
Ø 310 mm KU 316/31



KU 316/42  
230 x 120 mm  
männlich / male



KU 316/43  
220 x 135 mm  
weiblich / female

AA

AB

AC

AD

AE

AF

AK

AL

AM

AO

AP

AR

KA

KD

**KU**

KY

Nagelzangen  
Nail Nippers  
Pinzas corta-unas  
Pinces à ongles  
Tronchesine per unghie



**MAYO**  
KU 318/14  
14,0 cm/5½"



**MAYO**  
KU 320/14  
14,0 cm/5½"



**CHEATE**  
KU 321/27  
27,0 cm/10¾"



**ROGGE**  
KU 322/23  
23,0 cm/9"



**PYE-SMITH (HARRISON)**  
KU 323/25 25,0 cm/10"  
KU 323/30 30,0 cm/12"



KU 325/18  
18,0 cm/7"





KU 328/01  
50 x 75 mm



KU 329/01  
Ø 30,0 mm



KU 329/02  
Ø 30,0 mm

Disposable dappen dish  
Kunststoff - plastic - plástico - plastique - plastica



KU 332/01  
Verpackungseinheit / packing unit 1000 St./pc.  
250 pro Farbe / 250 per colour

Glass dappen dish  
Glas - glass - cristal - verre - vetro



KU 333/01

KU 333/02

KU 333/03

KU 333/04

Verpackungseinheit / packing unit  
2 St. pro Farbe / 2 pcs. per colour

AA

AB

AC

AD

AE

AF

AK

AL

AM

AO

AP

AR

KA

KD

KU

KY

Glas-Anmischplatten / glass mixing slabs

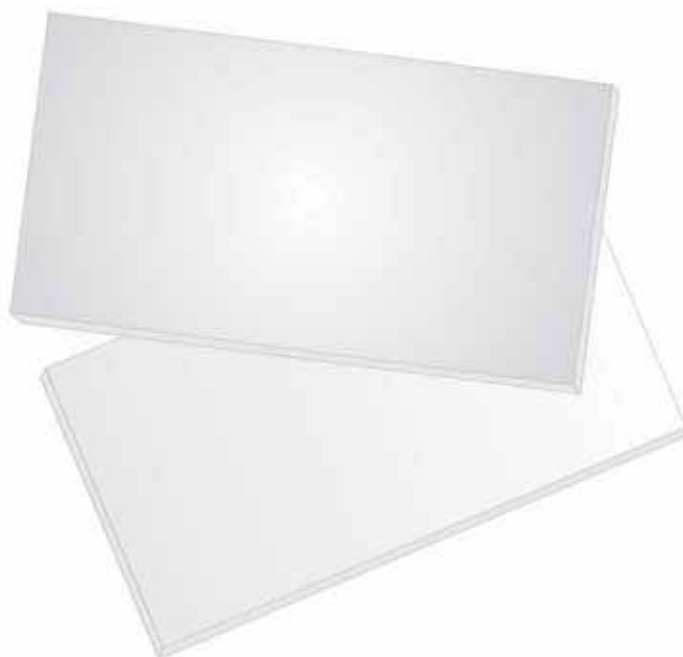

KU 335/02  
150 x 80 x 2 mm



KU 340/01  
Ø 11,0 mm  
15,0 cm/6"



KU 340/02  
Ø 11,0 mm  
11,0 cm/4 1/8"



KU 340/03  
Ø 11,0 mm  
14,0 cm/5 1/2"

---

FUSSPFLEGE  
PODIATRY  
PEDICURA  
SOINS DES PIEDS  
PEDICURE

**KU**

**nopa**<sup>®</sup> instruments



Nagelzangen  
Nail Nippers  
Pinzas corta-uñas  
Pincès à ongles  
Tronchesine per unghie

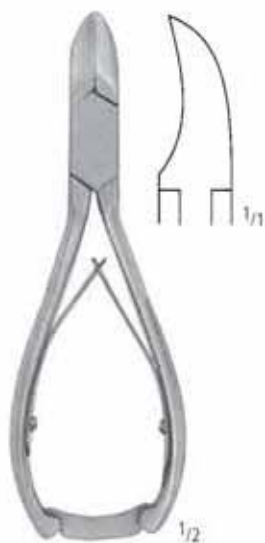

KU 800/14  
14,0 cm/5 1/2"



KU 802/14  
14,0 cm/5 1/2"



KU 803/13  
13,0 cm/5"



**TURNBULL**  
11,5 cm/4 1/2" KU 804/11  
13,0 cm/5" KU 804/13



KU 806/14  
14,0 cm/5 1/2"



KU 808/14  
14,0 cm/5 1/2"

Nagelzangen  
Nail Nippers  
Pinzas corta-uñas  
Pinces à ongles  
Tronchesine per unghie

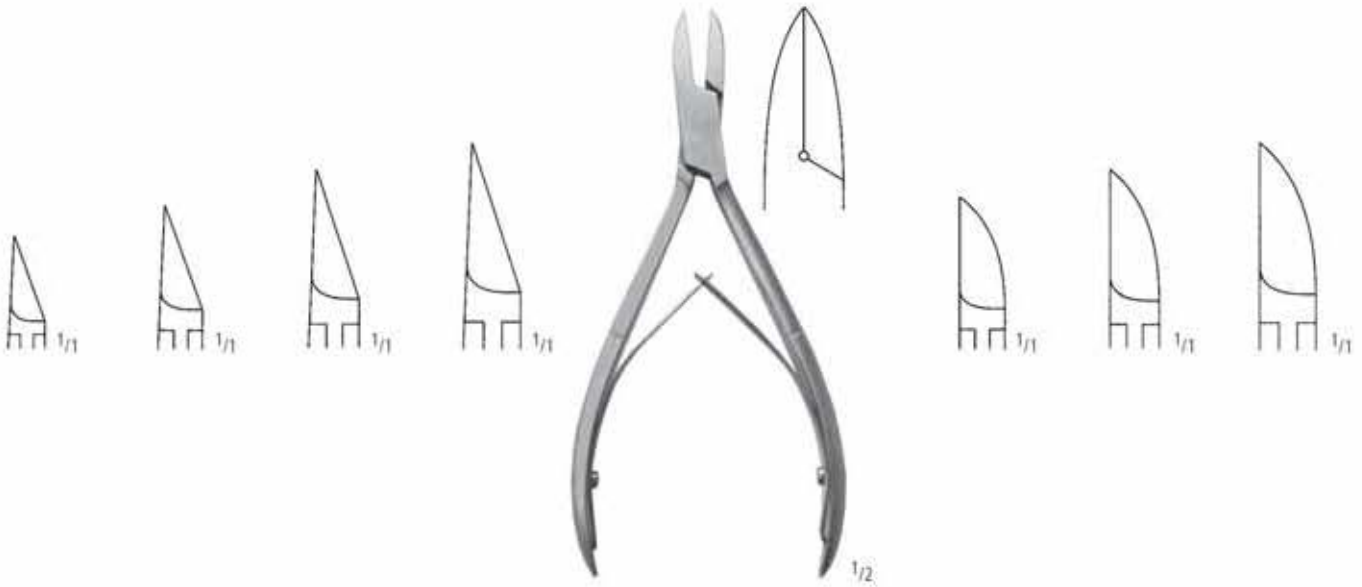

KU 810/10  
KU 810/11  
KU 810/12  
KU 810/15

**LITTAUER**  
10,0 cm/4"  
11,0 cm/4<sup>1</sup>/<sub>3</sub>"  
12,5 cm/5"  
15,0 cm/6"

KU 811/11  
KU 811/12  
KU 811/15



KU 812/12  
12,0 cm/4<sup>3</sup>/<sub>4</sub>"

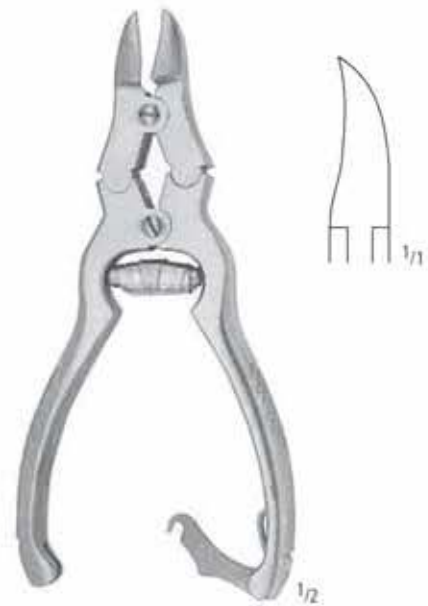

KU 814/15  
14,5 cm/5<sup>3</sup>/<sub>4</sub>"

AA

AB

AC

AD

AE

AF

AK

AL

AM

AO

AP

AR

KA

KD

**KU**

KY

Nagelzangen  
 Nail Nippers  
 Pinzas corta-uñas  
 Pincès à ongles  
 Tronchesine per unghie

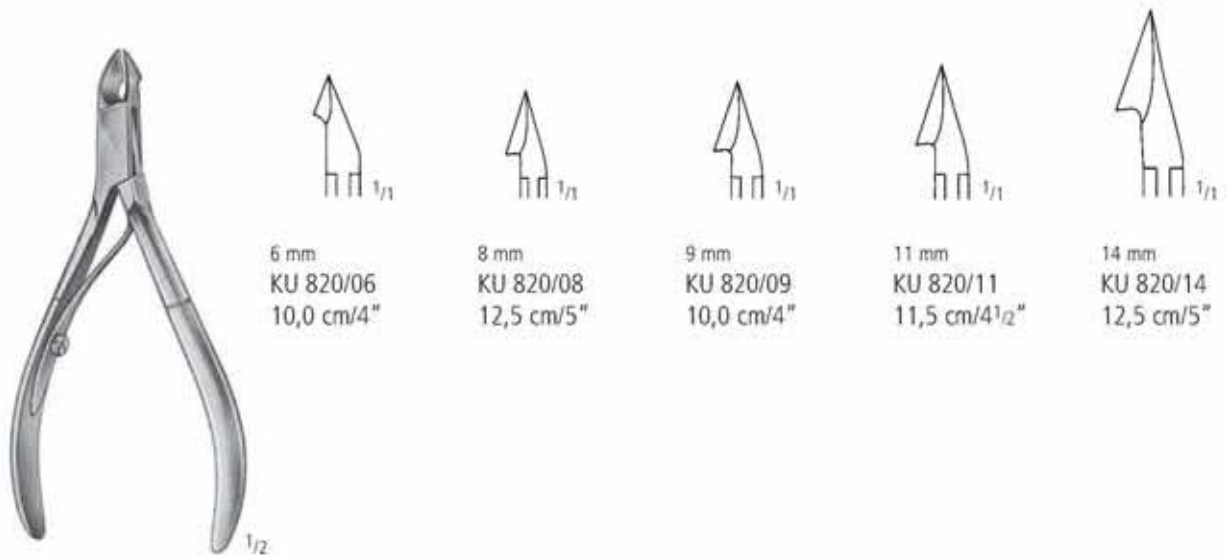



AA  
AB  
AC  
AD  
AE  
AF  
AK  
AL  
AM  
AO  
AP  
AR  
KA  
KD  
KY



**RADOLF**  
13,5 cm/5<sup>1</sup>/<sub>4</sub>"

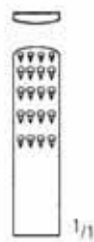

6 mm  
KU 830/06



4 mm  
KU 831/04



**ANVIL**  
KU 832/12  
12,5 cm/5"



KU 840/08  
8,0 cm/3"



KU 842/10  
10,0 cm/4"



KU 842/11



KU 842/12



KU 842/13

Satz - Set  
KU 842/00 = KU 842/10  
KU 842/11  
KU 842/12  
KU 842/13

KU



KU 850/01  
15,0 cm/6"



KU 850/02  
15,0 cm/6"



KU 850/03  
12,0 cm/4<sup>3</sup>/<sub>4</sub>"



KU 850/04  
13,5 cm/5<sup>1</sup>/<sub>4</sub>"



KU 850/05  
13,5 cm/5<sup>1</sup>/<sub>4</sub>"



KU 850/06  
13,0 cm/5"



KU 850/07  
14,0 cm/5 1/2"



KU 850/08  
13,0 cm/5"



KU 850/09  
14,0 cm/5 1/2"



KU 850/10  
15,5 cm/6"

AA

AB

AC

AD

AE

AF

AK

AL

AM

AO

AP

AR

KA

KD

**KU**

KY



KU 850/20  
14,0 cm/5 1/2"



KU 850/21  
14,0 cm/5 1/2"



KU 850/22  
14,0 cm/5 1/2"



Ø 1,0 mm KU 850/30  
Ø 1,5 mm KU 850/31  
Ø 2,0 mm KU 850/32  
Ø 2,5 mm KU 850/33  
12,5 cm/5"



KU 850/35  
12,5 cm/5"



KU 854/01  
13,0 cm/5"



KU 854/02  
12,0 cm/4<sup>3</sup>/<sub>4</sub>"



KU 854/03  
11,0 cm/4<sup>1</sup>/<sub>2</sub>"



KU 854/04  
14,0 cm/5<sup>1</sup>/<sub>2</sub>"



KU 854/05  
11,0 cm/4<sup>1</sup>/<sub>2</sub>"



KU 860/01  
15,0 cm/6"



KU 860/02  
15,0 cm/6"



KU 862/17  
17,0 cm/6<sup>3</sup>/<sub>8</sub>"



KU 863/14  
14,0 cm/5<sup>1</sup>/<sub>2</sub>"



KU 864/16  
15,5 cm/6"



KU 865/14  
14,0 cm/5<sup>1</sup>/<sub>2</sub>"





KU 866/13  
13,0 cm/5"

KU 866/15  
15,0 cm/6"



KU 867/16  
16,0 cm/6 1/4"



KU 868/16  
16,0 cm/6 1/4"



KU 869/16  
16,0 cm/6 1/4"



KU 870/15  
15,0 cm/6"



AA  
AB  
AC  
AD  
AE  
AF  
AK  
AL  
AM  
AO  
AP  
AR  
KA  
KD  
KY  
KU



KU 872/15  
15,5 cm/6"



KU 873/16  
16,0 cm/6 1/4"



KU 874/18  
18,0 cm/7"



KU 876/20  
Ø 1,5 mm + 2,0 mm  
14,5 cm/5 3/4"



KU 876/25  
Ø 1,5 mm + 2,5 mm  
14,5 cm/5 3/4"



KU 878/01  
13,0 cm/5"

Nagel-Feilen  
Nail-files  
Limas de uñas  
Limes à ongles  
Lime per le unghie



KU 891/10  
10,0 cm/4"



KU 892/12  
11,5 cm/4 1/2"



KU 894/15  
15,0 cm/6"



KU 896/00

AA  
AB  
AC  
AD  
AE  
AF  
AK  
AL  
AM  
AO  
AP  
AR  
KA  
KD  
KY

KU



---

REINIGUNGSBÜRSTEN  
CLEANING BRUSHES  
CEPILLOS DE LIMPIEZA  
BROSSES POUR NETTOYER  
SPAZZOLI PER PULIRE

**KY**

**nopa**<sup>®</sup> instruments







STERILISATION STERILIZATION ESTERILIZACION STERILISATION STERILIZZAZIONE

Reinigungsbürsten  
 Cleaning brushes  
 Cepillos de limpieza  
 Brosses pour nettoyer  
 Spazzoli per pulire

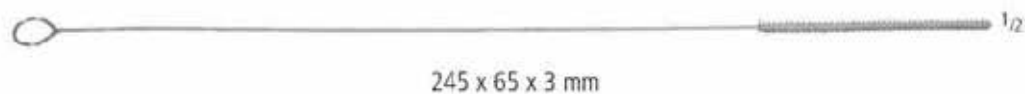
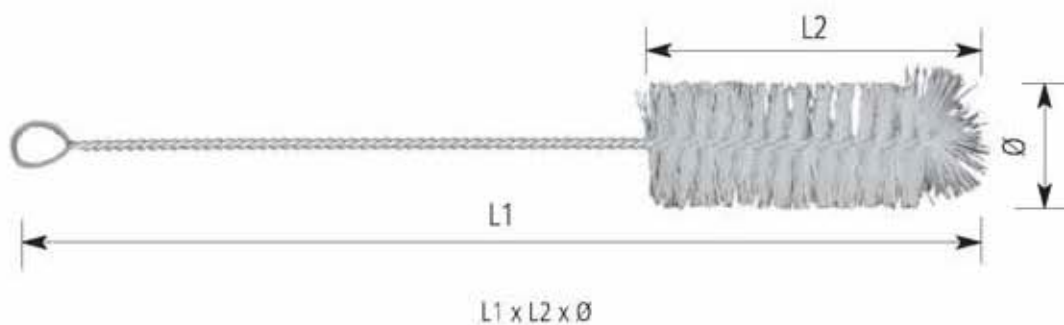

KY 800/03

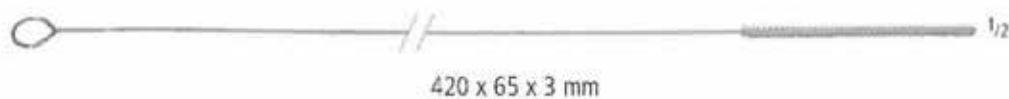

KY 801/03

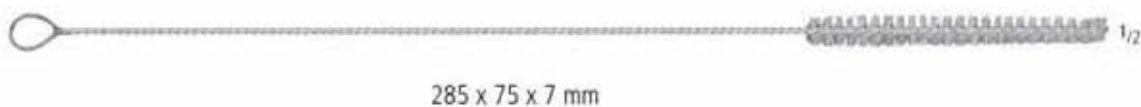

KY 802/07

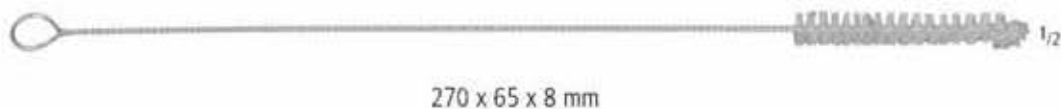

KY 803/08

AA

AB

AC

AD

AE

AF

AK

AL

AM

AO

AP

AR

KA

KD

KU

KY

Reinigungsbürsten  
 Cleaning brushes  
 Cepillos de limpieza  
 Brosses pour nettoyer  
 Spazzoli per pulire



270 x 65 x 12 mm

KY 803/12



215 x 60 x 13 mm

KY 803/13



215 x 70 x 15 mm

KY 803/15



215 x 65 x 20 mm

KY 803/20



215 x 65 x 25 mm

KY 803/25



215 x 65 x 30 mm

KY 803/30

Reinigungsbürsten  
 Cleaning brushes  
 Cepillos de limpieza  
 Brosses pour nettoyer  
 Spazzoli per pulire



KY 804/00 = KY 805/13  
 KY 805/15  
 KY 805/20  
 KY 805/25  
 KY 805/28



215 x 60 x 13 mm

KY 805/13



215 x 65 x 15 mm

KY 805/15



215 x 95 x 20 mm

KY 805/20



215 x 95 x 25 mm

KY 805/25



215 x 100 x 28 mm

KY 805/28

AA

AB

AC

AD

AE

AF

AK

AL

AM

AO

AP

AR

KA

KD

KU

KY

KY

Reinigungsbürsten  
 Cleaning brushes  
 Cepillos de limpieza  
 Broses pour nettoyer  
 Spazzoli per pulire



275 x 65 x 12 mm

KY 806/12



275 x 80 x 15 mm

KY 806/15



300 x 120 x 30 mm

KY 806/30



320 x 130 x 50 mm

KY 806/50



360 x 140 x 35 mm

KY 807/35



420 x 180 x 40 mm

KY 808/40

Reinigungsbürsten  
 Cleaning brushes  
 Cepillos de limpieza  
 Brosses pour nettoyer  
 Spazzoli per pulire

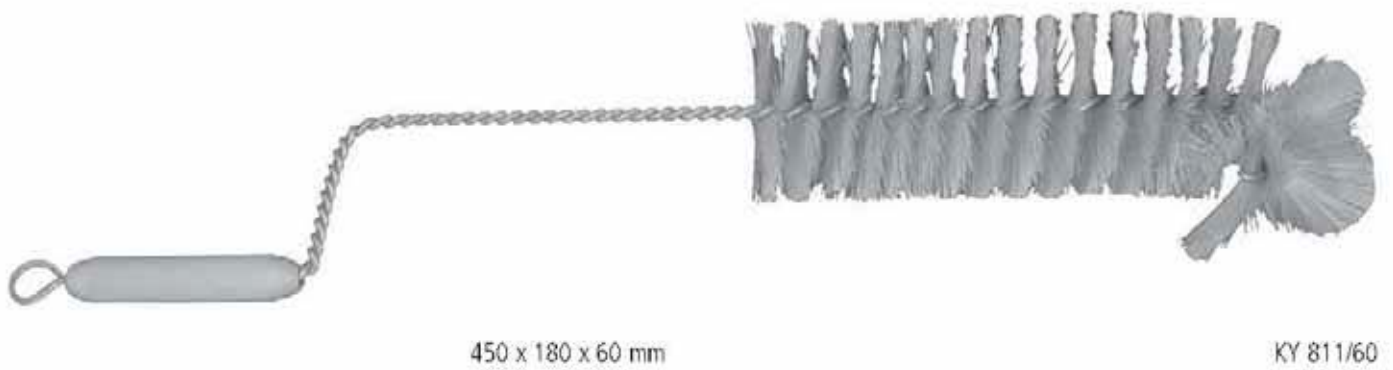
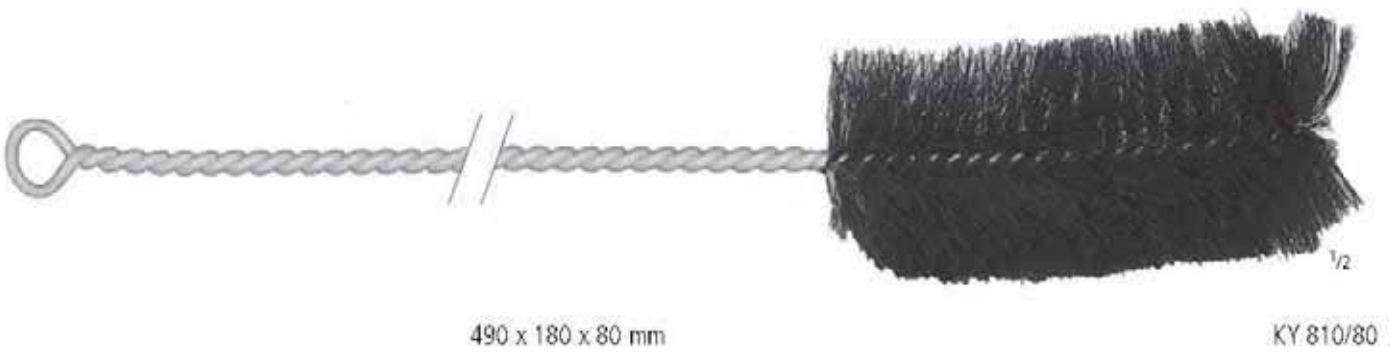
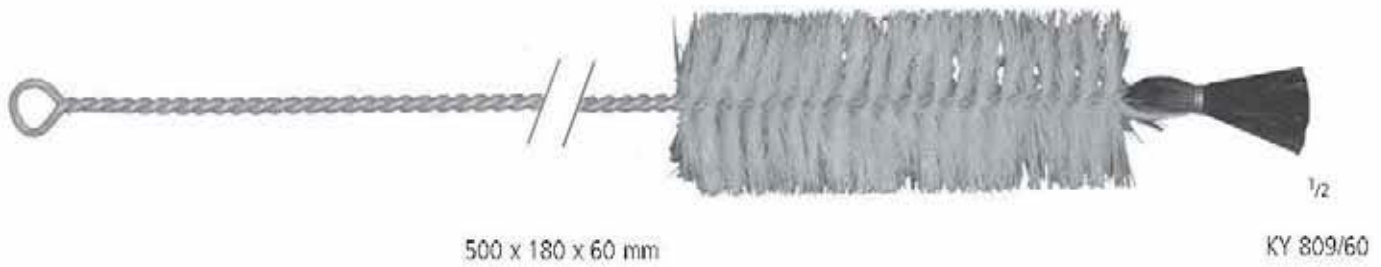

AA  
 AB  
 AC  
 AD  
 AE  
 AF  
 AK  
 AL  
 AM  
 AO  
 AP  
 AR  
 KA  
 KD  
 KU  
 KY

Reinigungsbürsten  
 Cleaning brushes  
 Cepillos de limpieza  
 Brosses pour nettoyer  
 Spazzoli per pulire



330 x 130 x 50 mm

KY 813/50



400 x 190 x 8/20 mm

<sup>1/2</sup>  
 KY 814/20



300 x 110 x 18/33 mm

<sup>1/2</sup>  
 KY 815/33



320 x 70 x 15/25 mm

<sup>1/2</sup>  
 KY 816/25



420 x 60 x 8/15 mm

<sup>1/2</sup>  
 KY 817/15



Reinigungsbürsten  
 Cleaning brushes  
 Cepillos de limpieza  
 Brosses pur nettoyer  
 Spazzoli per pulire

AA

AB

AC

AD

AE

AF

AK

AL

AM

AO

AP

AR

KA

KD

KU

KY

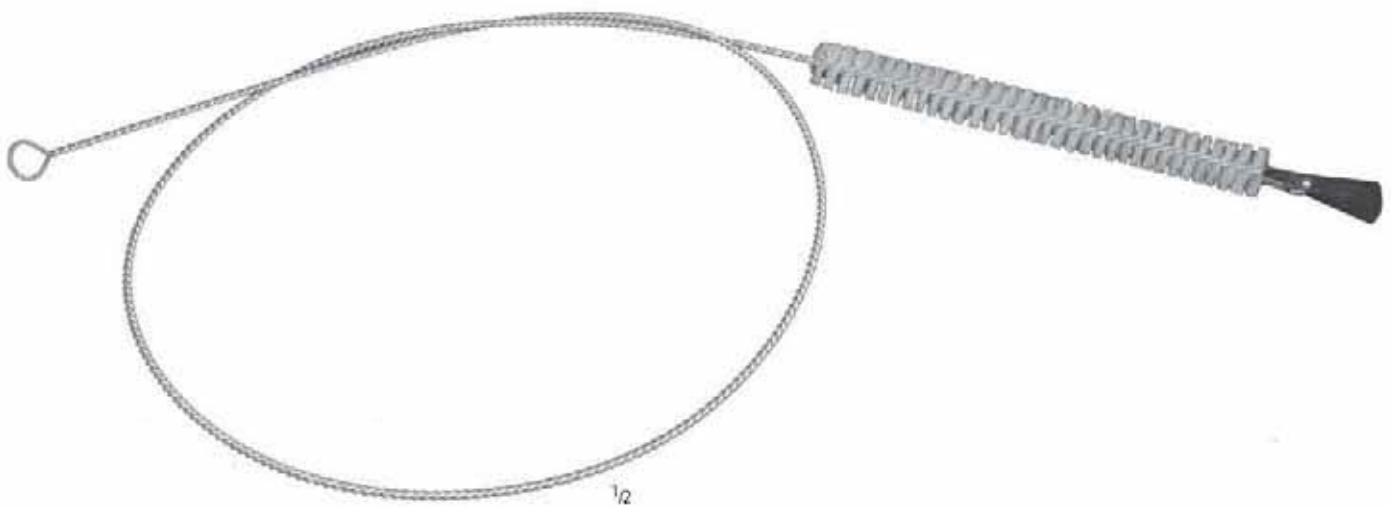

1/2  
 1000 x 180 x 16 mm

KY 818/16



210 x 95 mm

KY 819/95

Reinigungspistole  
 Spray gun  
 Pistola lavatoria  
 Pistolet laveur  
 Pistola lavatrice



KY 940/01

## KY 940/00

Reinigungspistole und Ansatzset komplett KY 940/01 + KY 945/00  
 Spray gun and set of attachment complete KY 940/01 + KY 945/00  
 Pistola lavatoria y set de toberas completo con KY 940/01 + KY 945/00  
 Pistolet laveur et set d'embouts complet avec KY 940/01 + KY 945/00  
 Pistola lavatrice e set di to raccordi completo con KY 940/01 + KY 945/00

Die nopa Reinigungspistole ist das ideale Werkzeug für die Reinigung von Laborgläsern, Pipetten, Spritzen, Kathetern, Küvetten, Endoskopen, Cystoskopen, Kanülen und anderen Gegenständen in Klinik, Labor und Praxis – also überall dort, wo es auf höchste Sauberkeit und Hygiene ankommt.

Die Reinigung erfolgt mit Wasser oder Druckluft besonders schnell, effizient und damit kostensparend.

Bei der neuen nopa Reinigungspistole ist der Wasser- oder Luftstrahl durch eine neuartige Dosiermechanik stufenlos über die gesamte Betätigungsstrecke des Abzughahns fein dosierbar.

Der maximale Wasser- oder Luftfluss kann auch mit der kleinen Rändelschraube hinter dem Abzughahn individuell eingestellt werden.

The nopa Spray Gun is the ideal instrument for cleaning laboratory glassware, pipettes, syringes, catheters, cuvettes, endoscopes, cystoscopes, cannulae and a variety of other instruments and articles used in clinics, laboratories, and medical practices – in other words, everywhere where highest cleanliness and hygiene are mandatory.

The nopa Spray Gun uses either water or pressurized air – this means the cleaning process is quick, efficient and inexpensive.

The nopa Spray Gun features a new type of internal flow control mechanism. It permits the smooth and simple adjustment of the water or air flow across the entire range of the trigger movement.

The desired maximum water or air flow can be set by using the small knurled screw located behind the trigger. It is then regulated via the trigger up to the set maximum value.

Reinigungspistole  
 Spray gun  
 Pistola lavatoria  
 Pistolet laveur  
 Pistola lavatrice



Fig.1 KY 945/01    Fig.2 KY 945/02    Fig.3 KY 945/03    Fig.4 KY 945/04    Fig.5 KY 945/05    Fig.6 KY 945/06    Fig.7 KY 945/07    Fig.8 KY 945/08

KY 945/00 – KY 945/01  
 KY 945/02  
 KY 945/03  
 KY 945/04  
 KY 945/05  
 KY 945/06  
 KY 945/07  
 KY 945/08

- >> Spülen, Saugen und Trocknen für die unterschiedlichsten Einsatzgebiete wird durch ein Sortiment von 8 Ansätzen ermöglicht.
- >> Das Standard-Set mit 8 Ansätzen wird auf einer stabilen Aufsteckleiste für die Wandmontage geliefert. Damit ist jedes Einzelteil sicher und griffbereit aufbewahrt.

- >> Rinsing, suction or drying in every area of application is made possible through the set of 8 attachments.
- >> The standard set of 8 attachments is delivered on a stable storage rack for mounting on the wall. All attachments are kept within easy reach.

AA  
 AB  
 AC  
 AD  
 AE  
 AF  
 AG  
 AH  
 AI  
 AJ  
 AK  
 AL  
 AM  
 AN  
 AO  
 AP  
 AQ  
 AR  
 AS  
 AT  
 AU  
 AV  
 AW  
 AX  
 AY  
 AZ  
 BA  
 BB  
 BC  
 BD  
 BE  
 BF  
 BG  
 BH  
 BI  
 BJ  
 BK  
 BL  
 BM  
 BN  
 BO  
 BP  
 BQ  
 BR  
 BS  
 BT  
 BU  
 BV  
 BW  
 BX  
 BY  
 BZ  
 CA  
 CB  
 CC  
 CD  
 CE  
 CF  
 CG  
 CH  
 CI  
 CJ  
 CK  
 CL  
 CM  
 CN  
 CO  
 CP  
 CQ  
 CR  
 CS  
 CT  
 CU  
 CV  
 CW  
 CX  
 CY  
 CZ  
 DA  
 DB  
 DC  
 DD  
 DE  
 DF  
 DG  
 DH  
 DI  
 DJ  
 DK  
 DL  
 DM  
 DN  
 DO  
 DP  
 DQ  
 DR  
 DS  
 DT  
 DU  
 DV  
 DW  
 DX  
 DY  
 DZ  
 EA  
 EB  
 EC  
 ED  
 EE  
 EF  
 EG  
 EH  
 EI  
 EJ  
 EK  
 EL  
 EM  
 EN  
 EO  
 EP  
 EQ  
 ER  
 ES  
 ET  
 EU  
 EV  
 EW  
 EX  
 EY  
 EZ  
 FA  
 FB  
 FC  
 FD  
 FE  
 FF  
 FG  
 FH  
 FI  
 FJ  
 FK  
 FL  
 FM  
 FN  
 FO  
 FP  
 FQ  
 FR  
 FS  
 FT  
 FU  
 FV  
 FW  
 FX  
 FY  
 FZ  
 GA  
 GB  
 GC  
 GD  
 GE  
 GF  
 GG  
 GH  
 GI  
 GJ  
 GK  
 GL  
 GM  
 GN  
 GO  
 GP  
 GQ  
 GR  
 GS  
 GT  
 GU  
 GV  
 GW  
 GX  
 GY  
 GZ  
 HA  
 HB  
 HC  
 HD  
 HE  
 HF  
 HG  
 HH  
 HI  
 HJ  
 HK  
 HL  
 HM  
 HN  
 HO  
 HP  
 HQ  
 HR  
 HS  
 HT  
 HU  
 HV  
 HW  
 HX  
 HY  
 HZ  
 IA  
 IB  
 IC  
 ID  
 IE  
 IF  
 IG  
 IH  
 II  
 IJ  
 IK  
 IL  
 IM  
 IN  
 IO  
 IP  
 IQ  
 IR  
 IS  
 IT  
 IU  
 IV  
 IW  
 IX  
 IY  
 IZ  
 JA  
 JB  
 JC  
 JD  
 JE  
 JF  
 JG  
 JH  
 JI  
 JJ  
 JK  
 JL  
 JM  
 JN  
 JO  
 JP  
 JQ  
 JR  
 JS  
 JT  
 JU  
 JV  
 JW  
 JX  
 JY  
 JZ  
 KA  
 KB  
 KC  
 KD  
 KE  
 KF  
 KG  
 KH  
 KI  
 KJ  
 KK  
 KL  
 KM  
 KN  
 KO  
 KP  
 KQ  
 KR  
 KS  
 KT  
 KU  
 KV  
 KW  
 KX  
 KY  
 KZ  
 LA  
 LB  
 LC  
 LD  
 LE  
 LF  
 LG  
 LH  
 LI  
 LJ  
 LK  
 LL  
 LM  
 LN  
 LO  
 LP  
 LQ  
 LR  
 LS  
 LT  
 LU  
 LV  
 LW  
 LX  
 LY  
 LZ  
 MA  
 MB  
 MC  
 MD  
 ME  
 MF  
 MG  
 MH  
 MI  
 MJ  
 MK  
 ML  
 MM  
 MN  
 MO  
 MP  
 MQ  
 MR  
 MS  
 MT  
 MU  
 MV  
 MW  
 MX  
 MY  
 MZ  
 NA  
 NB  
 NC  
 ND  
 NE  
 NF  
 NG  
 NH  
 NI  
 NJ  
 NK  
 NL  
 NM  
 NN  
 NO  
 NP  
 NQ  
 NR  
 NS  
 NT  
 NU  
 NV  
 NW  
 NX  
 NY  
 NZ  
 OA  
 OB  
 OC  
 OD  
 OE  
 OF  
 OG  
 OH  
 OI  
 OJ  
 OK  
 OL  
 OM  
 ON  
 OO  
 OP  
 OQ  
 OR  
 OS  
 OT  
 OU  
 OV  
 OW  
 OX  
 OY  
 OZ  
 PA  
 PB  
 PC  
 PD  
 PE  
 PF  
 PG  
 PH  
 PI  
 PJ  
 PK  
 PL  
 PM  
 PN  
 PO  
 PP  
 PQ  
 PR  
 PS  
 PT  
 PU  
 PV  
 PW  
 PX  
 PY  
 PZ  
 QA  
 QB  
 QC  
 QD  
 QE  
 QF  
 QG  
 QH  
 QI  
 QJ  
 QK  
 QL  
 QM  
 QN  
 QO  
 QP  
 QQ  
 QR  
 QS  
 QT  
 QU  
 QV  
 QW  
 QX  
 QY  
 QZ  
 RA  
 RB  
 RC  
 RD  
 RE  
 RF  
 RG  
 RH  
 RI  
 RJ  
 RK  
 RL  
 RM  
 RN  
 RO  
 RP  
 RQ  
 RR  
 RS  
 RT  
 RU  
 RV  
 RW  
 RX  
 RY  
 RZ  
 SA  
 SB  
 SC  
 SD  
 SE  
 SF  
 SG  
 SH  
 SI  
 SJ  
 SK  
 SL  
 SM  
 SN  
 SO  
 SP  
 SQ  
 SR  
 SS  
 ST  
 SU  
 SV  
 SW  
 SX  
 SY  
 SZ  
 TA  
 TB  
 TC  
 TD  
 TE  
 TF  
 TG  
 TH  
 TI  
 TJ  
 TK  
 TL  
 TM  
 TN  
 TO  
 TP  
 TQ  
 TR  
 TS  
 TT  
 TU  
 TV  
 TW  
 TX  
 TY  
 TZ  
 UA  
 UB  
 UC  
 UD  
 UE  
 UF  
 UG  
 UH  
 UI  
 UJ  
 UK  
 UL  
 UM  
 UN  
 UO  
 UP  
 UQ  
 UR  
 US  
 UT  
 UY  
 UZ  
 VA  
 VB  
 VC  
 VD  
 VE  
 VF  
 VG  
 VH  
 VI  
 VJ  
 VK  
 VL  
 VM  
 VN  
 VO  
 VP  
 VQ  
 VR  
 VS  
 VT  
 VU  
 VV  
 VW  
 VX  
 VY  
 VZ  
 WA  
 WB  
 WC  
 WD  
 WE  
 WF  
 WG  
 WH  
 WI  
 WJ  
 WK  
 WL  
 WM  
 WN  
 WO  
 WP  
 WQ  
 WR  
 WS  
 WT  
 WU  
 WV  
 WW  
 WX  
 WY  
 WZ  
 XA  
 XB  
 XC  
 XD  
 XE  
 XF  
 XG  
 XH  
 XI  
 XJ  
 XK  
 XL  
 XM  
 XN  
 XO  
 XP  
 XQ  
 XR  
 XS  
 XT  
 XU  
 XV  
 XW  
 XX  
 XY  
 XZ  
 YA  
 YB  
 YC  
 YD  
 YE  
 YF  
 YG  
 YH  
 YI  
 YJ  
 YK  
 YL  
 YM  
 YN  
 YO  
 YP  
 YQ  
 YR  
 YS  
 YT  
 YU  
 YV  
 YW  
 YX  
 YZ  
 ZA  
 ZB  
 ZC  
 ZD  
 ZE  
 ZF  
 ZG  
 ZH  
 ZI  
 ZJ  
 ZK  
 ZL  
 ZM  
 ZN  
 ZO  
 ZP  
 ZQ  
 ZR  
 ZS  
 ZT  
 ZU  
 ZV  
 ZW  
 ZX  
 ZY  
 ZZ





# Inhaltsverzeichnis

	Seite		Seite
<b>A</b>		<b>B</b>	
Abszessmesser	174	<b>BABCOCK</b> , Darmfazzangen	9, 519
<b>ADAMS-MAYO</b> , selbsthaltende Wundsperrer	296	<b>BABINSKY</b> , Perkussionshammer	369
<b>ADISON</b> , Schutzzange	390	<b>BABY KOCHER</b> , Atraumatische Magen- und Darmklemmen	526
<b>ADLERKREUTZ</b> , Pinzetten	65	<b>BABY-ADSON</b> , Arterienklemmen	25
<b>ADSON</b> , selbsthaltende Wundsperrer	290, 291	<b>BABY-ADSON</b> , selbsthaltende Wundsperrer	292
<b>ADSON</b> , Arterienklemmen	25	<b>BABY-BALFOUR</b> , Bauchdeckenhalter	299
<b>ADSON</b> , Elevatorien	449	<b>BABY-COLLIN</b> , Bauchdeckenhalter	304
<b>ADSON</b> , Hartmetallpinzetten TUC	93	<b>BABY-CRILE-WOOD</b> , Hartmetallnadelhalter TUC	196
<b>ADSON</b> , Nadelhalter	183	<b>BABY-CRILE-WOOD</b> , Nadelhalter	182
<b>ADSON</b> , Pinzetten	59, 60	<b>BABY-DOYEN</b> , Magen- und Darmklemmen	520
<b>ADSON</b> , Saugrohre	335	<b>BABY-KOCHER</b> , Magen- und Darmklemmen	521, 526
<b>ADSON-ANDERSON</b> , selbsthaltende Wundsperrer	290	<b>BABY-LEXER</b> , Präparierschere	111
<b>ADSON-BABY</b> , Arterienklemmen	25	<b>BABY-LIGHTWEIGHT-DUPLEX</b> , Stethoskop	378
<b>ADSON-BABY</b> , selbsthaltende Wundsperrer	292	<b>BABY-METZENBAUM</b> , Präparierschere	108
<b>ADSON-BECKMANN</b> , selbsthaltende Wundsperrer	293	<b>BABY-MIKULICZ</b> , Peritoneumklemme	49
<b>ADSON-BROWN</b> , Pinzetten	60	<b>BABY-MIXTER</b> , Präparier- und Ligaturklemmen	33
<b>ADSON-MICRO</b> , Pinzetten	59	<b>BABY-OVERHOLT</b> , Präparier- und Ligaturklemme	23
<b>ADSON-TOENNIS</b> , Gefäßscheren	116	<b>BABY-POOLE</b> , Saugrohre	332
<b>ADSON-TOENNIS-DELICATE</b> , Hartmetallscheren TUC	161	<b>BABY-SENN-MILLER</b> , feine Wundhaken	250
<b>ADVENTITIA</b> , Mikroscheren	145, 147	<b>BABY-WEITLANER</b> , selbsthaltende Wundsperrer	287
Akku / Ladegeräte	393	<b>BACKHAUS</b> , Tuchklemmen	52
Akku Bohraparat	391	<b>BACON</b> , Hohlmeißelzangen	470
<b>ALAN PARKS</b> , Anuskope	537	<b>BAINBRIDGE</b> , Arterienklemmen	27
<b>ALDERDYCE</b> , Elevatorien	448	<b>BAINBRIDGE</b> , Atraumatische Magen- und Darmklemmen	524
<b>ALEXANDER</b> , Meißel	418	<b>BALFOUR</b> , Bauchdeckenhalter	299, 300
<b>ALEXANDER</b> , Raspatorien	446	<b>BALFOUR-BABY</b> , Bauchdeckenhalter	299
<b>ALLIS</b> , Fasszängchen	517	<b>BALFOUR-US-TYPE</b> , Bauchdeckenhalter	299
<b>ALLIS</b> , Gewebefasszängchen	9	<b>BALL &amp; SOCKET</b> , Tuchklemmen	52
<b>ALLIS-ADAIR</b> , Fasszängchen	517	<b>BALLANTINE-HEANEY</b> , Hysterektomieklappen	43
<b>ALLIS-BABY</b> , Fasszängchen	517	<b>BALLENGER-FOERSTER</b> , Schwammzangen	237
<b>ALM</b> , selbsthaltende Wundsperrer	283	<b>BARRAQUER</b> , Cilienpinzetten	76
<b>ALY</b> , Sensibilitätsinstrument	376	<b>BARRAQUER</b> , Iridektomieschere	138
Ampullenspritzen	347	<b>BARRAQUER</b> , Mikronadelhalter	206
Amputations- und Resektionssägen	384	<b>BARRAQUER</b> , Vorderkammer-Pinzetten	85
Amputationsmesser	172	<b>BARRAQUER-KATZIN (COLIBRI)</b> , Irispinzetten	82
Amputationsschild	463	<b>BARRAQUER-KATZIN</b> , Hornhautscheren	142
Anastomosenklemmen	528, 529, 532, 533	<b>BARRAQUER-TROUTMAN</b> , Mikronadelhalter	206
Anatomiescheren	118	<b>BARRAYA-STILLE</b> , Pinzetten	65
<b>ANDERSON-ADSON</b> , selbsthaltende Wundsperrer	290	Bauchdeckenhalter	298-307
<b>ANDREWS-PYNCHON</b> , Saugrohre	331	Bauchdeckenscheren	106
Anlegezangen	11	Bauchspatel	308
Anuskope	537-543	<b>BAUMGARTNER</b> , Nadelhalter	184
<b>ANVIL</b> , Nagelspaltzange	571	<b>BECK-LUETHY</b> , Hartmetallnadelhalter TUC	202
<b>ARLT-FISCHER</b> , Irispinzetten	80	<b>BECKMANN</b> , selbsthaltende Wundsperrer	292
<b>ARRUGA</b> , Hartmetallnadelhalter TUC	201	<b>BECKMANN-ADSON</b> , selbsthaltende Wundsperrer	293
<b>ARRUGA</b> , Kapselpinzetten	83	<b>BECKMANN-EATON</b> , selbsthaltende Wundsperrer	293
<b>ARRUGA</b> , Mikronadelhalter	212	<b>BEEBEE</b> , Kronenschere	130, 131
<b>ARRUGA</b> , Nadelhalter	180	<b>BEER</b> , Cilienpinzetten	76
<b>ARRUGA-KALT</b> , Mikronadelhalter	212	<b>BEESON</b> , Gipsspreizer	319
Arterienklemmen	13-23, 25-28	<b>BENGOLEA</b> , Arterienklemmen	28
Arterienklemmen, grazil	22	<b>BENSAUDE</b> , Anuskope	540
Arthroskopie	408-415	<b>BERENS</b> , Muskelpinzetten	88
Artikulationspapierpinzetten	98	<b>BERGMANN</b> , Gipssäge	318
Atraumatische Magen- und Darmklemmen	524-527	<b>BERGMANN</b> , Hämmer	427
Atraumatische Pinzetten	91	<b>BERGMANN</b> , Verbandschere	132
Augenschere	125-127, 138-143	<b>BERKE</b> , Chalazionspinzetten	89
Aurikelklemmen	29	<b>BERLINER</b> , Perkussionshammer	370
<b>AUSTIN</b> , Knüpfpinzetten	71	<b>BERNHARD</b> , Tuchklemmen	51
<b>AUSTRALIA</b> , Fingerwundspreizer	283	Besteck, Diagnostik-	380, 381
<b>AUSTRALIA</b> , Wundspreizer für die Handchirurgie	285	Besteck, Krampfader-	312
Autopsie-Säge	483-485	<b>BEYER</b> , Hohlmeißelzangen	471
<b>AYER</b> , Chalazionspinzetten	88	<b>BILLROTH</b> , Wundhaken	252
		<b>BINKHORST</b> , Kapselpinzetten	83

	Seite		Seite
Biopsiekaniülen	343, 344	<b>CARMALT-WALTER</b> , Splitterpinzetten	73
<b>BIRCHER</b> , Meniskotome	467	<b>CAROLL</b> , Goniometer	373
<b>BIRCHER-GANSKE</b> , Knochenhaltezzangen	453	<b>CAROLL</b> , Sehnenfassinstrumente	464
<b>BIRKETT</b> , Präparier- und Ligaturklemmen	41	<b>CARREL</b> , Arterienklemme	14
<b>BISHOP-HARMAN</b> , Irispinzetten	82	<b>CARROLL</b> , Hartmetallnadelhalter TUC	194
<b>BLASCOVICS</b> , Muskelpinzetten	87	<b>CARROLL</b> , Nadelhalter	182
Bleihände	482	<b>CARTILAGE-MARTIN</b> , Scheren	118
<b>BLOND</b> , Anuskope	542, 543	<b>CASTROVIEJO</b> , Fixierpinzetten	84
<b>BLOUNT</b> , Knochenhebel	398	<b>CASTROVIEJO</b> , Hartmetallmikronadelhalter TUC	204, 205
<b>BLOUNT</b> , Meniskushaken	466	<b>CASTROVIEJO</b> , Hornhautscheren	138
<b>BLUEPOWER</b> , elektrische Gipsäge	322	<b>CASTROVIEJO</b> , Hornhautscheren	141
<b>BLUMENTHAL</b> , Hohlmeißelzangen	469	<b>CASTROVIEJO</b> , Iridektomieschere	138
Blutdruckmessapparate	379	<b>CASTROVIEJO</b> , Kapselpinzetten	83
<b>BÖHLER</b> , Extensionsbügel	399	<b>CASTROVIEJO</b> , Klingenbrecher	177
<b>BÖHLER</b> , Hohlmeißelzangen	471	<b>CASTROVIEJO</b> , Mikronadelhalter	210, 213
Bohrdrähte	499-502	<b>CASTROVIEJO</b> , Nahtpinzetten	85
<b>BOLEY</b> , Schieblehre	373	<b>CASTROVIEJO</b> , Zirkel	375
<b>BONACCOLTO</b> , Nahtpinzetten	85	<b>CASTROVIEJO-EPKER</b> , Zirkel	375
<b>BONN MOD.</b> , Nahtpinzetten	86	<b>CASTROVIEJO-KALT</b> , Mikronadelhalter	212
<b>BONNEY</b> , Fasspinzetten	68	<b>CATLIN</b> , Amputationsmesser	172
<b>BONNEY</b> , Hartmetallpinzetten TUC	94	<b>CHADWICK</b> , Augenschere	126
Boomerang Nadelhalter	189	Chalazionspinzetten	88, 89
<b>BÖTTCHER</b> , Tonsillenschere	119	<b>CHAPUT</b> , Fasszangen	12
<b>BOYNTON</b> , Hartmetallnadelhalter TUC	201	<b>CHARRIERE</b> , Amputationssägen	384
<b>BOYNTON</b> , Nadelhalter	180	<b>CHEATLE</b> , Sterilisierzangen	564
<b>BOYS-ALLIS</b> , Fasszängchen	518	<b>CHERON</b> , Tupferzangen	234
<b>BOZEMANN</b> , Hartmetallnadelhalter TUC	197	<b>CHILDE</b> , Wundklammerpinzetten	225
<b>BOZEMANN</b> , Nadelhalter	182	Chirurgische Scheren	102-105, 122
<b>BOZEMANN</b> , Nahtinstrumente	223	<b>CHRIS-TROUTMAN</b> , Klingenbrecher	177
<b>BOZEMANN</b> , Tupferzangen	233	<b>CHURCH</b> , Gefäßschere	117
<b>BOZEMANN-DOUGLAS</b> , Tupferzangen	233	Cilienpinzetten	76
<b>BRAND</b> , Sehnenfassinstrumente	464	<b>CLAR 55</b> , Stirnlampen	368
<b>BRAUN-STADLER</b> , Episiotomieschere	121	<b>CLAR STANDARD</b> , Stirnlampen	368
<b>BRIDGE</b> , Präparier- und Ligaturklemmen	34	<b>CLASSON</b> , Gefäßschere	117
<b>BRODIE</b> , Sonden	311	<b>CLAUS</b> , Unterbindungsnadeln	218
Bronchusklemmen	30	<b>CLAUS-EICKEN</b> , Unterbindungsnadeln	219
<b>BROPHY</b> , Pinzetten	63	<b>CLEVELAND</b> , Hohlmeißelzangen	468
<b>BROPHY-SULLIVAN</b> , feine Scheren	123	<b>CLEVELAND</b> , Knochensplitterzangen	478
<b>BROWN</b> , Nadelhalter	183	<b>CLEVELAND-GARDNER</b> , Knochensplitterzangen	477
<b>BROWN</b> , Pinzetten	64	<b>CLOWARD HIBBS SPRATT</b> , scharfe Löffel	437
<b>BROWN-ADSON</b> , Pinzetten	60	<b>COAKLEY</b> , Trokare	330
<b>BROWNE-DENIS</b> , Bauchdeckenhalter	301	<b>COBB</b> , Elevatorien	449
<b>BRUNNER</b> , Führungshohlsonden	220	<b>COBB</b> , Meißel	424
<b>BRUNNER</b> , Magen- und Darmklemmen	520	<b>COBB</b> , scharfe Löffel	439
<b>BRUNNER</b> , Unterbindungsnadeln	216, 217	<b>COGSWELL</b> , Saugrohre	336
<b>BRUNNER</b> , Wundhaken	263	<b>COLIBRI (BARRAQUER-KATZIN)</b> , Irispinzetten	82
<b>BRUNNER-FERROZELL</b> , Führungshohlsonden	222	<b>COLLEGE-LONDON</b> , Zahnpinzetten	95
<b>BRUNS</b> , Gipschere	134	<b>COLLER</b> , Arterienklemmen	17
<b>BRUNS</b> , scharfe Löffel	434, 437	<b>COLLIER</b> , Nadelhalter	180
<b>BRYANT</b> , Schwammzange	228	<b>COLLIN</b> , Amputationsmesser	172
<b>BUCK</b> , Ligaturschere	129	<b>COLLIN</b> , Bauchdeckenhalter	304, 305
<b>BUCK</b> , Perkussionshammer	369	<b>COLLIN</b> , Dynamometer	374
<b>BUELAU</b> , Trokare	328	<b>COLLIN</b> , Fasszange	13
Bulldogklemmen	10, 11	<b>COLLIN</b> , Hämmer	429
<b>BUNNELL</b> , Handbohrapparate	388	<b>COLLIN</b> , Skalpelle	170
<b>BUNNELL</b> , Sehnenstripper	465	<b>COLLIN</b> , Skalpellgriffe	166
<b>BUSCH</b> , Nabelschnurschere	121	<b>COLLIN</b> , Tupferzangen	234
<b>BYRD</b> , Saugrohre	332	<b>COLLIN</b> , Wundklammerzängchen	224
		<b>COLLIN-BABY</b> , Bauchdeckenhalter	304
<b>C</b>		<b>COLLIN-DUVAL</b> , Fasspinzette	66
<b>CAIRNS</b> , Arterienklemmen	22	<b>COLLIN-HARTMANN</b> , Wundhaken	277
<b>CAMPBELL</b> , Trokare	328	<b>CONE</b> , selbsthaltende Wundsperrer	292
<b>CANNY RYALL</b> , Wundhaken	279	<b>CONVERSE</b> , Hartmetallnadelhalter TUC	195
<b>CAPLAN</b> , Nasenschere	119	<b>CONVERSE-DERF</b> , Nadelhalter	180
<b>CARDINALE</b> , Gynäkologische Schere	107	<b>COOLEY</b> , Gefäßdilatoren	313
<b>CARDINALE</b> , Hartmetallschere TUC	155	<b>COOLEY</b> , Saugrohre	333
<b>CARDIOPHON</b> , Stethoskop	378	<b>COOPER</b> , Unterbindungsnadeln	216
<b>CARMALT-ROCHESTER</b> , Arterienklemmen	27	<b>CORNEAL (TROUTMAN)</b> , Irispinzetten	82
		Coronarschere	115



	Seite		Seite
<b>CORWIN</b> , Drahtzangen TUC	403	<b>DERF-CONVERSE</b> , Nadelhalter	180
<b>CORWIN</b> , Hartmetalldrahtzangen TUC	203	Dermatome	176
<b>CORYLLOS</b> , Wundhaken	274	<b>DESCHAMPS</b> , Unterbindungsnadeln	215
<b>COTTLE KAZANJIAN</b> , Knochensplitterzangen	477	<b>DESJARDINS</b> , Gallenkanalklemmen	40
<b>COTTLE</b> , Hämmer	428	<b>DESMARRES</b> , Chalazionspinzetten	88
<b>COTTLE</b> , Nasenpinzetten	77	<b>DESMARRES</b> , feine Wundhaken	248
<b>COTTLE</b> , Nasenscheren	120	Diagnostik	367-382
<b>COUPLAND</b> , Saugröhre	332	Diagnostikbestecke	380, 381
<b>COUPLAND</b> , Saugröhre	337	<b>DICK</b> , Anastomosenklemmen	528
<b>CRAFOORD</b> , Bronchusklemme	30	<b>DIEFFENBACH</b> , Abszessmesser	174
<b>CRAFOORD</b> , Scheren	118	<b>DIEFFENBACH</b> , Bulldogklemmen	11
<b>CRAFOORD-SELLORS</b> , Aurikelklemmen	29	<b>DIEFFENBACH</b> , Skalpelle	170, 171
<b>CRANE-KAPLAN</b> , Markierungspinzetten	98	<b>DIETRICH</b> , Hartmetallmikronadelhalter TUC	205
<b>CREGO</b> , Knochenhebel	398	<b>DIETRICH-HEGEMANN</b> , Gefäßscheren	114
<b>CRILE</b> , Arterienklemmen	17	Dilatatoren, Gefäß-	313, 314
<b>CRILE</b> , Nadelhalter	187	<b>DINGMANN</b> , Knorpelfasszange	453
<b>CRILE-MURRAY</b> , Nadelhalter	182	<b>DIPLOMAT</b> , Blutdruckmessapparate	379
<b>CRILE-RANKIN</b> , Arterienklemmen	17	<b>DISSECTION</b> , Mikroscheren	145, 147
<b>CRILE-WOOD</b> , Hartmetallnadelhalter TUC	196	<b>DIXON-LOVELACE</b> , Arterienklemmen	26
<b>CRILE-WOOD</b> , Nadelhalter	182	<b>DOUGLAS</b> , Cilienpinzetten	76
<b>CRILE-WOOD-BABY</b> , Hartmetallnadelhalter TUC	196	<b>DOUGLAS</b> , Trokare	330
<b>CRILE-WOOD-BABY</b> , Nadelhalter	182	<b>DOUGLAS-BOZEMANN</b> , Tupferzangen	233
<b>CULLEN-WERTHEIM</b> , Hysterektomieklemmen	44	<b>DOYEN</b> , Atraumatische Magen- und Darmklemmen	524
<b>CUSHING</b> , feine Wundhaken	244, 248	<b>DOYEN</b> , Bauchdeckenhalter	302
<b>CUSHING</b> , Flachbohrer	387	<b>DOYEN</b> , Hämmer	428
<b>CUSHING</b> , Hartmetallpinzetten TUC	93	<b>DOYEN</b> , Magen- und Darmklemmen	520, 524
<b>CUSHING</b> , Pinzetten	62	<b>DOYEN</b> , Nadelhalter	180
<b>CUSHING</b> , Spinalhaken	250	<b>DOYEN</b> , Raspatorien	445
<b>CUSHING-TAYLOR</b> , Hartmetallpinzetten TUC	93	<b>DOYEN</b> , Scheren	106
<b>CZERNY</b> , Mastdarm-Spekula	534	<b>DOYEN</b> , Sonden	310
<b>CZERNY</b> , Wundhaken	279	<b>DOYEN</b> , Tuchklemmen	51
		<b>DOYEN</b> , Wundhaken	267
<b>D</b>		<b>DOYEN-STILLE</b> , Wundhaken	266
		Drahtscheren	130
<b>DAHMEN</b> , Meißel	425	Drahtspanninstrumente	407
<b>DAHMEN</b> , Osteotome	425	Drahtzangen	401-403, 405, 406
<b>DANDY</b> , Gefäßscheren	115	Drahtzangen mit Hartmetalleinsätzen TUC	203
<b>DANDY</b> , Kopfhautklemmen	26	Druckklemmen	47, 48
<b>DARLING</b> , selbsthaltende Wundsperrer	295	<b>DUBOIS</b> , Gynäkologische Scheren	107
Darm- und Magenklemmen	520-523	<b>DUEHRSEN</b> , Pinzetten	64
Darm- und Magenquetschklemmen	530	<b>DUNHILL</b> , Arterienklemme	22
Darmfasszangen	9	<b>DUPLAY</b> , Kornzangen	236
Darmfasszangen	517-519	<b>DUPLEX-LIGHTWEIGHT/BABY</b> , Stethoskope	378
Darmklemmen	532, 533	<b>DURANTE</b> , Fasspinzetten	68
Darmscheren	118	<b>DUVAL</b> , Darmfasszangen	519
<b>DAVIDSON</b> , Wundhaken	276	<b>DUVAL</b> , Fasspinzetten	68
<b>DAVIS-RAGNELL</b> , feine Wundhaken	250	<b>DUVAL-COLLIN</b> , Fasspinzetten	66
<b>DE BAKEY</b> , Atraumatische Pinzetten	91	Dynamometer	374
<b>DE BAKEY</b> , Gefäßdilatoren	314	<b>DYNAMOMETER III</b>	374
<b>DE BAKEY</b> , Gefäßscheren	113, 116		
<b>DE BAKEY</b> , Hartmetallnadelhalter TUC	192	<b>E</b>	
<b>DE BAKEY</b> , Hartmetallpinzetten TUC	94	<b>EASTMAN-RICHARDSON</b> , Wundhaken	264
<b>DE BAKEY</b> , Hartmetallscheren TUC	157	<b>EATON-BECKMANN</b> , selbsthaltende Wundsperrer	293
<b>DE BAKEY</b> , Saugröhre	331	<b>ECHLIN</b> , Hohlmeißelzangen	474
<b>DE LA ROZA</b> , Unterbindungsnadeln	217	<b>ECONOM</b> , Diagnostikbestecke	380
<b>DE MARTEL-POTTS</b> , Gefäßscheren	116	<b>EICKEN</b> , Trokare	330
<b>DE MARTEL-WOLFSON</b> , Anastomosenklemmen	532, 533	<b>EICKEN-CLAUS</b> , Unterbindungsnadeln	219
<b>DE MARTEL-WOLFSON</b> , Darmklemmen	532, 533	<b>EICKEN-KILLIAN</b> , Saugkanüle	335
<b>DEAN</b> , Hartmetallscheren TUC	162	<b>EISELSBERG</b> , Ligaturscheren	128
<b>DEAN</b> , Zahnfleischscheren	136	Elektrische Gipsäge	321, 322
<b>DEAN-DELICATE</b> , Zahnfleischscheren	136	Elevatoren	447-449, 481
<b>DEAVER</b> , Chirurgische Scheren	104	<b>ELSCHNIG</b> , Fixierpinzetten	84
<b>DEAVER</b> , Wundhaken	269-271	<b>ENGEL</b> , Gipsäge	318
Deckglaspinzetten	78	<b>ENGLISCHES MODELL</b> , Tuchklemmen	51
<b>DEJERINE</b> , Perkussionshammer	370	Entropiumpinzetten	88
<b>DEMEL</b> , Drahtspanninstrumente	407	Episiotomiescheren	121
<b>DENIS BROWNE</b> , Bauchdeckenhalter	301	<b>ERHARDT</b> , Entropiumpinzette	88
<b>DERF</b> , Hartmetallnadelhalter TUC	195	<b>ESMARCH</b> , Gipsmesser	318
<b>DERF</b> , Nadelhalter	180		

	Seite		Seite
<b>ESMARCH</b> , Verbandsscheren	134	<b>FRENCH-EYE-RYDER</b> , Hartmetallnadelhalter TUC	193
<b>EUFRATE PASQUE</b> , Hartmetallnadelhalter TUC	193	<b>FRIEDMAN</b> , Hohlmeißelzangen	468
<b>EWALD</b> , Pinzetten	60	<b>FRIEDMAN-MICRO</b> , Hohlmeißelzange	476
<b>EXCENTRIC-LISTER</b> , Verbandsscheren	133	<b>FRIEDRICH</b> , Nahtinstrumente	223
Extensionsbügel	399, 400	<b>FRITSCH</b> , Wundhaken	266
<b>F</b>		<b>FRYKHOLM</b> , Hohlmeißelzangen	474
Facelift Markierer	376	<b>FUCHS-GILL</b> , Irispinzetten	83
Face-Lift-Scheren TUC	161	Führungshohlsonden	220-222
Fadenfänger	223	Führungsnadeln	346
Fadenknoter	223	<b>FULTON</b> , Gefäßscheren	117
Fadenschlingendreher	223	Fußpflege	568-579
<b>FALK</b> , Unterbindungsnadeln	219	<b>G</b>	
<b>FARABEUF</b> , Knochenhaltezangen	458	Gallenkanalklemmen	37, 40
<b>FARABEUF</b> , Raspatorien	443	<b>GARRETT</b> , Gefäßdilatatoren	313
<b>FARABEUF</b> , Wundhaken	278	Gefäßchirurgiescheren	113-117
<b>FARABEUF-LAMBOTTE</b> , Knochenhaltezangen	458	Gefäßdilatatoren	72, 313, 314
<b>FARRELL</b> , Watteträger	311	Gefäßklemmen	12
Fasspinzetten	66-68, 70, 316	Gefäßstripper	315
Fasszangen	12, 13, 316	<b>GEISSENDOERFER-OVERHOLT</b> , Arterienklemmen	23
<b>FAULKNER</b> , Linsenhaltepinzette	90	<b>GELPI</b> , selbsthaltende Wundsperrer	294
<b>FAURE</b> , Hysterektomieklemmen	45	<b>GEMINI</b> , Präparier- und Ligaturklemmen	35
<b>FAURE</b> , Peritoneumklemmen	50	<b>GERALD</b> , Pinzetten	62
<b>FAVALORO</b> , Gefäßscheren	115	<b>GERSTER</b> , Knochenhalteklammern	394
<b>FEHLAND</b> , Atraumatische Magen- und Darmklemmen	527	<b>GERSTER-LOWMAN</b> , Knochenhalteklammern	394
<b>FEILCHENFELD</b> , Splitterpinzetten	73	Gewebefasszängchen	9
<b>FEIN</b> , Watteträger	312	Gewebefasszängchen	517, 518
Feine Arterienklemmen	15	<b>GILL</b> , Kapselpinzetten	83
Feine Scheren	124	<b>GILL-FUCHS</b> , Irispinzetten	83
Feine Wundhaken	242-250	<b>GILL-HESS</b> , Irispinzetten	82
<b>FERGUSON</b> , Chirurgische Scheren	104	<b>GILLIES</b> , feine Wundhaken	242
<b>FERGUSON</b> , Druckklemmen	47	<b>GILLIES</b> , Hartmetallnadelhalter TUC	198
<b>FERGUSON</b> , Knochenhaltezangen	455	<b>GILLIES</b> , Hartmetallpinzetten TUC	92
<b>FERGUSON</b> , Saugrohre	335	<b>GILLIES</b> , Nadelhalter	185
<b>FERREIRA</b> , Wundhaken	280	<b>GILLIES</b> , Pinzetten	67
<b>FERRIS-SMITH</b> , Pinzetten	65	<b>GILLS-WELSH</b> , Kapsulotomieschere	140
<b>FERROZELL</b> , Führungshohlsonden	222	<b>GIL-VERNET</b> , feine Wundhaken	249
<b>FERROZELL-BRUNNER</b> , Führungshohlsonden	222	Gipsabreisszange	320
<b>FERROZELL-KIRSCHNER</b> , Führungshohlsonden	222	Gipsmesser	318
<b>FIBRE OPTIC</b> , Kaltlichtlaryngoskope	360	Gipssäge	318
Fingerringssägen	482	Gipssäge, elektrisch	321, 322
Fingerwundspreizer	283	Gipsschere	134
<b>FINOCCHIETTO</b> , Hartmetallnadelhalter TUC	197	Gipsscheren	320
<b>FINOCCHIETTO</b> , Nadelhalter	185	Gipsspreizer	319
<b>FINOCCHIETTO</b> , Nierenstielklemmen	37	Gipstrepine	318
<b>FINOCCHIETTO</b> , Scheren	118	<b>GOELET</b> , Wundhaken	279
<b>FINSEN</b> , selbsthaltende Wundsperrer	283	<b>GOLDMAN-FOX SPEZIAL</b> , Zahnfleischeren	136
<b>FISCHER-ARLT</b> , Irispinzetten	80	<b>GOLDMAN-FOX</b> , Hartmetallscheren TUC	161
Fistelmesser	174	<b>GOLDMAN-FOX</b> , Zahnfleischeren	136
Fistelscheren	106	Goniometer	373
Fixierpinzetten	84	<b>GOOD</b> , Tonsillenscheren	119
Flachzangen	404	<b>GOOD-SCHWECKENDICK</b> , Tonsillenscheren	119
<b>FLAGG</b> , Zahnpinzetten	96	<b>GORNEY</b> , Präparierscheren	111
<b>FLETCHER</b> , Schwammzangen	232	<b>GOSSET</b> , Bauchdeckenhalter	298
<b>FOERSTER</b> , Irispinzetten	81	<b>GRADLE</b> , Cilienpinzetten	76
<b>FOERSTER-BALLENGER</b> , Schwammzangen	237	<b>GRAEFE</b> , Augenscheren	126
<b>FOMON</b> , Nasenscheren	119	<b>GRAEFE</b> , feine Wundhaken	243
<b>FOMON</b> , Präparierscheren	111	<b>GRAEFE</b> , Fixierpinzetten	84
<b>FOREGGER-WISCONSIN FIBRE OPTIC</b> , Laryngoskope	358	<b>GRAEFE</b> , Irispinzetten	79
<b>FOREGGER-WISCONSIN</b> , Laryngoskope	354	<b>GRAY</b> , Gallenkanalklemmen	40
<b>FOX</b> , scharfe Löffel	436	<b>GRAZIL</b> , Chirurgische Scheren	103
<b>FOX-GOLDMAN SPEZIAL</b> , Zahnfleischeren	136	Grazile Arterienklemmen	22
<b>FOX-GOLDMAN</b> , Zahnfleischeren	136	<b>GREEN</b> , Fixierpinzetten	84
<b>FRANKENFELDT</b> , Fasszange	316	<b>GREEN-SENN</b> , feine Wundhaken	247
<b>FRANZ</b> , Bauchdeckenhalter	302	<b>GROSS-MAIER</b> , Kornzangen	230, 231
<b>FRAZIER</b> , feine Wundhaken	242	<b>GRUENWALD</b> , Nasenpinzetten	78
<b>FRAZIER</b> , Saugrohre	335	<b>GRUENWALD-JANSEN</b> , Nasenpinzetten	78
<b>FREER</b> , Elevatorien	448	<b>GUTHRIE</b> , feine Wundhaken	246



	Seite		Seite
<b>GUYON</b> , Nierenstielklemmen	38, 39	<b>HOLINGER</b> , Laryngoskope	362
<b>GUYON-ARTRAUMATIC</b> , Nierenstielklemmen	39	<b>HOPKINS</b> , Gipsmesser	318
Gynäkologische Scheren	105-107	<b>HOPKINS-JOHNS</b> , Anlegezangen	11
<b>H</b>		<b>HOPKINS-JOHNS</b> , Bulldogklemmen	11
<b>HABERER</b> , Bauchspatel	308	<b>HOPKINS-JOHNS</b> , Präparier- und Ligaturklemmen	32
Hähne	349	<b>HORNE-JOBSON</b> , Watteträger	312
<b>HAJEK</b> , Hämmer	429	Hornhautscheren	141-143
Haken, Spinal-	250	<b>HÖSEL</b> , Hartmetallnadelhalter TUC	201
Haken, Wund-	242-308	<b>HÖSEL</b> , Nadelhalter	188
<b>HALLE</b> , Nasenscheren	120	<b>HOSPITAL-PROVIDENCE</b> , Arterienklemmen	16
<b>HALSEY</b> , Hartmetallnadelhalter TUC	195	<b>HRYNTSCHAK-YOUNG</b> , Nadelhalter	189
<b>HALSEY</b> , Nadelhalter	181	<b>HUDSON</b> , Handbohrapparate	387
<b>HALSTED</b> , Arterienklemmen	16	<b>HUMBY</b> , Dermatome	176
<b>HALSTED-MOSQUITO</b> , Arterienklemmen	15	<b>HUNT</b> , Pinzetten	70
Halter, Bauchdecken-	298-307	<b>HUNTER</b> , Splitterpinzetten	73
Hämmer	427-433	<b>HURD</b> , Unterbindungsnadeln	218
Hämmer, Perkussions-	369, 370	Hysterektomieklammern	41-45
Hämorrhoidal-Ligatoren	552-554	<b>I</b>	
Hämorrhoidenklammern	47, 48	Instrumentarium für Küntscher-Nägeln	488, 489
Hämorrhoidenklammern, atraumatisch	48	Instrumente, Mess-	371-375
Handbohrapparate	385-390	Instrumente, Sensibilitäts-	376
Handgriffe für Liposuktions- und Infiltrationskanülen	338, 340	Instrumentenablageplatten	561
<b>HARMAN-BISHOP</b> , Irispinzetten	82	Instrumentenkästen	562
<b>HARMS</b> , Nahtpinzetten	86	Inzisionsscheren	104
<b>HARRINGTON</b> , Wundhaken	267	<b>IOWA</b> , Spezialkanülen	345
<b>HARRINGTON-MAYO</b> , Scheren	105	Indektomiescheren	138
<b>HARRISON (PYE-SMITH)</b> , Sterilisierzange	564	Irispinzetten	79-82
<b>HARTMANN</b> , Arterienklemme	14	Irisscheren	125, 138
<b>HARTMANN</b> , Hohlmeißelzangen	469	<b>ISRAEL</b> , Wundhaken	253
Hartmetalleinsatzplättchen mit Pyramidenprofil	190, 191	<b>IVES-FANSLER</b> , Sphinkteroskope	538
<b>HARVEY</b> , Drahtscheren	130	<b>IWANSON</b> , Zirkel	375
<b>HATFIELD</b> , scharfe Löffel	439	<b>J</b>	
Hautscheren	135	<b>JACKSON</b> , Kaltlichtlaryngoskope	363
<b>HEANEY</b> , Hysterektomieklammern	43	<b>JACKSON</b> , Tamponpinzetten	78
<b>HEANEY</b> , Nadelhalter	184	<b>JACOBI</b> , Unterbindungsnadeln	217
<b>HEANEY</b> , Wundhaken	277	<b>JACOBS CHUCK</b> , Handbohrapparate	388
<b>HEANEY-BALLANTINE</b> , Hysterektomieklammern	43	<b>JACOBSON</b> , Hartmetallmikronadelhalter TUC	204
<b>HEANEY-KANTER</b> , Hysterektomieklammern	43	<b>JACOBSON</b> , Hartmetallnadelhalter TUC	194
<b>HEANEY-REZAK</b> , Hysterektomieklammern	44	<b>JACOBSON</b> , Mikronadelhalter	210
<b>HEATH</b> , Ligaturscheren	129	<b>JACOBSON</b> , Nadelhalter	182
<b>HEATH-RICHTER</b> , Wundklammerzängchen	224	<b>JAMESON</b> , Muskelpinzetten	87
<b>HEGAR-OLSEN</b> , Hartmetallnadelhalter TUC	198	<b>JAMESON</b> , Nadelhalter	184
<b>HEGAR-OLSEN</b> , Nadelhalter	185	<b>JAMESON</b> , Schieblehre	372
<b>HEGEMANN-DIETRICH</b> , Gefäßscheren	114	<b>JANET</b> , Spritzen	348
<b>HEGENBARTH</b> , Wundklammerpinzetten	224	<b>JANSEN</b> , Nasenpinzetten	77
<b>HEIFETZ</b> , Pinzetten	70	<b>JANSEN</b> , scharfe Löffel	440
<b>HEISS</b> , Arterienklemmen	30	<b>JANSEN</b> , selbsthaltende Wundsperrern	284
<b>HELFERICH-BIER</b> , Amputationssägen	384	<b>JANSEN-GRUENWALD</b> , Nasenpinzetten	78
<b>HEMINGWAY</b> , scharfe Löffel	441	<b>JEWELER</b> , Hartmetallpinzetten TUC	92
<b>HENAHAN</b> , Wiesheitszahnhaken	481	<b>JOBSON-HORNE</b> , Watteträger	312
<b>HENLEY</b> , selbsthaltende Wundsperrern	288	<b>JOHANSSON</b> , Trokare	329
<b>HENNIG</b> , Gipsspreizer	319	<b>JOHNS HOPKINS</b> , Präparier- und Ligaturklemmen	32
<b>HERRICK</b> , Nierenstielklemmen	39	<b>JOHNS-HOPKINS</b> , Anlegezangen	11
<b>HESS</b> , Irispinzetten	81	<b>JOHNS-HOPKINS</b> , Bulldogklemmen	11
<b>HESSBERG</b> , Unterbindungsnadeln	217	<b>JONES</b> , Tuchklemmen	51
<b>HESS-GILL</b> , Irispinzetten	82	<b>JOSEPH</b> , feine Wundhaken	246
<b>HEYMANN</b> , Nasenscheren	120	<b>JOSEPH</b> , Präparierscheren	112
<b>HEYWOOD-SMITH</b> , Schwammzangen	236	<b>JUDD-ALLIS</b> , Fasszangen	518
<b>HIBBS</b> , Meißel	420	<b>K</b>	
<b>HIBBS</b> , Osteotome	420	<b>KADER</b> , Wundhaken	273
Hirnmesser	173	<b>KALT</b> , Hartmetallmikronadelhalter TUC	205
<b>HIRSCHMANN</b> , Anuskope	539	<b>KALT</b> , Mikronadelhalter	212
<b>HOEN</b> , Elevatorien	448	<b>KALT-ARRUGA</b> , Mikronadelhalter	212
<b>HOESEL</b> , Wundhaken	265		
Hohlmeißelzangen	468-476		
<b>HOHMANN</b> , Knochenhebel	396, 397		
<b>HOKE</b> , Osteotome	417		

	Seite		Seite
<b>KALT-CASTROVIEJO</b> , Mikronadelhalter	212	Knochenhalteklammern	394
Kaltlichtlaryngoskope	357-360	Knochenhaltezangen	452, 454-462
Kaltlichtträger	363	Knochenhebel	395-398
Kamm	564	Knochenschrauben	505-512
<b>KANTER-HEANEY</b> , Hysterektomieklemmen	43	Knochensplitterzangen	477-480
<b>KANTROWITZ</b> , Präparier- und Ligaturklemmen	35	Knorpelscheren	118
Kanülen, Biopsie-	343, 344	<b>KNOWLES</b> , Verbandscheren	133
Kanülen, Spezial-	345	Knüpfpinzetten mit Plateau	71, 72
<b>KAPLAN-CRANE</b> , Markierungspinzetten	98	<b>KOCHER</b> , Atraumatische Magen- und Darmklemmen	525
Kapselpinzetten	83	<b>KOCHER</b> , Führungshohlsonden	222
Kapsulorhexispinzetten	90	<b>KOCHER</b> , Magen- und Darmklemmen	522, 525
Kapsulotomiescheren	140	<b>KOCHER</b> , Unterbindungsnadeln	216
Katheterzangen	361	<b>KOCHER</b> , Wundhaken	260, 266
<b>KATZIN</b> , Hornhautscheren	142	<b>KOCHER</b> , Wundhaken	251, 260, 266
<b>KATZIN-BARRAQUER</b> , Hornhautscheren	142	<b>KOCHER-DELICATE</b> , Arterienklemmen	22
<b>KAYE</b> , Face-Lift-Scheren TUC	161	<b>KOCHER-LANGENBECK</b> , Wundhaken	259
<b>KELLY</b> , Arterienklemmen	17	<b>KOCHER-OCHSNER</b> , Arterienklemmen	20, 21
<b>KELLY</b> , Fistelscheren	106	<b>KOERTE</b> , Wundhaken	252, 267
<b>KELLY</b> , Hartmetallschere TUC	153	<b>KÖNIG</b> , Führungshohlsonden	221
<b>KELLY</b> , Proktoskope	540, 541	<b>KÖNIG</b> , Nagelspaltscheren	135
<b>KELLY</b> , Schwammzangen	235	Kopfhautklemmen	12, 26
<b>KELLY</b> , Wundhaken	268	Kornzangen	229-239
<b>KELLY-RANKIN</b> , Arterienklemmen	17	Krampfaderbesteck	312
<b>KELLY-RICHARDSON</b> , Wundhaken	264	<b>KRAUSE</b> , Trokare	330
<b>KELMAN-McPHERSON</b> , Nahtpinzetten	85	<b>KROENLEIN</b> , Fasszange	13
<b>KERN</b> , Knochenhaltezangen	456	<b>KRONECKER</b> , Unterbindungsnadeln	218
<b>KERSTING</b> , Anastomosenklemmen	528	Kronenscheren	130, 131
<b>KILNER</b> , feine Wundhaken	242	Kropfscheren	119
<b>KILNER</b> , Hartmetallnadelhalter TUC	195	<b>KUEHNE</b> , Deckglaspinzetten	78
<b>KILNER</b> , Nadelhalter	181	<b>KÜNTSCHER</b> , Instrumentarium für Nägel	488, 489
<b>KILNER-RAGNELL</b> , Präparierscheren	112	<b>KÜNTSCHER</b> , Nägel	492-494
<b>KIRBY</b> , Irispinzetten	82	Küretten	434-441
<b>KIRSCHNER</b> , Bauchdeckenhalter	303	<b>KUTZ-KLEINERT</b> , feine Wundhaken	242
<b>KIRSCHNER</b> , Bohrdrähte	499-502		
<b>KIRSCHNER</b> , Extensionsbügel	400	<b>L</b>	
<b>KIRSCHNER</b> , Führungshohlsonden	222	<b>LA GRANGE</b> , Augenscheren	126
<b>KIRSCHNER</b> , Saugrohre	503	<b>LAHEY</b> , Gallenkanalklemmen	37
<b>KIRSCHNER-FERROZZELL</b> , Führungshohlsonden	222	<b>LAHEY</b> , Wundhaken	263
Klammern	496	<b>LAMBOTTE</b> , Knochenhaltezangen	460
Klammern, Wund-	225	<b>LAMBOTTE</b> , Osteotome	426
Kleiderscheren	132, 133	<b>LAMBOTTE</b> , Raspatorien	443
<b>KLEINERT-KUTZ</b> , feine Wundhaken	242	Lampen, Stirn-	368
<b>KLEINERT-KUTZ</b> , Hohlmeißelzangen	471	<b>LAMPERT</b> , Chalazionpinzette	89
<b>KLEINERT-KUTZ</b> , Sehnenfassinstrumente	464	<b>LANDAU</b> , Trokare	329
Klemmen	9-53	<b>LANDAU-SEGOND</b> , Hysterektomieklemmen	45
Klemmen, Arterien-	13-23, 25-28	<b>LANDGRAF</b> , Zahnpinzetten	97
Klemmen, Auriel-	29	<b>LANDOLT</b> , feine Scheren	124
Klemmen, Bronchus-	30	<b>LANE</b> , chirurgische Pinzetten	61
Klemmen, Bulldog-	10, 11	<b>LANE</b> , Knochenhaltezangen	457
Klemmen, Druck-	47, 48	<b>LANE</b> , Magenklemmen	531
Klemmen, Gallenkanal-	37, 40	<b>LANE</b> , Schraubenzieher	491
Klemmen, Hämorrhoiden-	47, 48	<b>LANE</b> , Tuchklemmen	51
Klemmen, Hysterektomie-	41-45	<b>LANGE</b> , Kleiderscheren	132
Klemmen, Kopfhaut-	12, 26	<b>LANGE</b> , Wundklammerpinzetten	225
Klemmen, Ligatur- und Präparier-	23-25, 29, 31-36	<b>LANGE-HOHMANN</b> , Knochenhebel	397
Klemmen, Nierenstiel-	37-39	<b>LANGENBECK</b> , Amputationsmesser	172
Klemmen, Parametrium-	46	<b>LANGENBECK</b> , Elevatorien	447
Klemmen, Peritoneum-	49, 50	<b>LANGENBECK</b> , Hartmetallnadelhalter TUC	202
Klemmen, Präparier- und Ligatur-	23-25, 29, 31-36	<b>LANGENBECK</b> , Knochenhaltezangen	455
Klemmen, Schlauch-	53	<b>LANGENBECK</b> , Nadelhalter	188
Klemmen, Tonsillen-	27	<b>LANGENBECK</b> , Raspatorien	443
Klemmen, Tuch-	51, 52	<b>LANGENBECK</b> , Resektionssägen	384
<b>KLIMA-ROSSEGGER</b> , Biopsiekanülen	343	<b>LANGENBECK</b> , Wundhaken	254, 258
Klingenbrecher	177	<b>LANGENBECK-DELICATE</b> , Hartmetallnadelhalter TUC	202
<b>KLINIKUM BERLIN</b> , Schlauchklemme	53	<b>LANGENBECK-KOCHER</b> , Wundhaken	259
<b>KLINKENBERGH-LOTH</b> , Gefäßscheren	117	<b>LANGENBECK-MINI</b> , feine Wundhaken	247
<b>KNAPP</b> , feine Wundhaken	246	<b>LANGENBECK-PARKER</b> , Wundhaken	278
<b>KNIGHTON</b> , selbsthaltende Wundsperrer	297	<b>LANGENBECK-RYDER</b> , Hartmetallnadelhalter TUC	202
Knochenfeilen	450		



	Seite		Seite
Laryngoskope	353-360	<b>MARKHAM-MEYERDING</b> , selbsthaltende Wundsperrer	294
Laryngoskope, Kaltlicht-	357-360	Markierungspinzetten	98
<b>LAWRENCE</b> , Präparier- und Ligaturklemmen	34	Marknägel	495
<b>LEKSELL-STILLE</b> , Hohlmeißelzangen	473	<b>MARKWALDER</b> , Knochensplitterzangen	477
<b>LEMPERT</b> , Hohlmeißelzangen	470	<b>MARQUARDT</b> , Hohlmeißelzangen	470
<b>LERICHE</b> , Arterienklemmen	16	<b>MARTEL</b> , Kopfhautklemmen	12
<b>LESTER</b> , Fixierpinzetten	84	<b>MARTEL-WILLET</b> , Kopfhautklemmen	12
<b>LEWIN</b> , Knochenhalte-zangen	454	<b>MARTIN</b> , Knorpelfasszangen	453
<b>LEXER</b> , Hartmetallscheren TUC	158	<b>MARTIN</b> , Wundhaken	262
<b>LEXER</b> , Meißel	422, 423	<b>MARTIN-CARTILAGE</b> , Scheren	118
<b>LEXER</b> , Osteotome	422, 423	<b>MARTINI</b> , scharfe Löffel	440
<b>LEXER</b> , Präparierscheren	111	<b>MASS.-GENERAL-HOSPITAL (M.G.H.)</b> , Nadelhalter	183
<b>LEXER-BABY</b> , Präparierscheren	111	<b>MASSE-ROBIN</b> , Bauchdeckenhalter	306
<b>LICHTENBERG</b> , Hartmetallnadelhalter TUC	201	<b>MASSON</b> , Hartmetallnadelhalter TUC	197
<b>LICHTENBERG</b> , Nadelhalter	187	<b>MASSON</b> , Nadelhalter	184
<b>LICHTWITZ</b> , Trokare	330	Mastdarm-Biopsiezangen	551
Ligatur- und Präparierklemmen	23-25, 29, 31-36	Mastdarm-Spekula	534-536
Ligaturscheren	128, 129	<b>MATHIEU</b> , Hartmetallnadelhalter TUC	199
<b>LINCOLN</b> , Gefäßscheren	117	<b>MATHIEU</b> , Mastdarm-Spekula	536
<b>LINDEMANN</b> , Resektionssägen	384	<b>MATHIEU</b> , Nadelhalter	186
Linsenhaltepinzetten	90	<b>MATHIEU</b> , Wundhaken	278
Liposuktions- und Infiltrationskanülen	339, 341, 342	<b>MATHIEU-DELICATE</b> , Hartmetallnadelhalter TUC	199
<b>LISTER</b> , Hartmetallscheren TUC	162	<b>MATHIEU-DELICATE</b> , Nadelhalter	186
<b>LISTER</b> , Tupferzangen	228	<b>MATHIEU-RYDER</b> , Hartmetallnadelhalter TUC	200
<b>LISTER</b> , Verbandscheren	133, 134	<b>MATHIEU-RYDER-VASCULAR</b> , Hartmetallnadelhalter TUC	200
<b>LISTER-EXCENTRIC</b> , Verbandscheren	133	<b>MATSON</b> , Raspatorien	446
<b>LISTON</b> , Amputationsmesser	172	<b>MAYFIELD</b> , Hohlmeißelzangen	470
<b>LISTON</b> , Knochensplitterzangen	477, 480	<b>MAYO ROBSON</b> , Atraumatische Magen- und Darmklemmen	526
<b>LISTON-KEY</b> , Knochensplitterzangen	479	<b>MAYO</b> , Hartmetallscheren TUC	153
<b>LITTAUER</b> , Cilienpinzetten	76	<b>MAYO</b> , Scheren	105
<b>LITTAUER</b> , Ligaturscheren	128	<b>MAYO</b> , Sterilisierklammern	564
<b>LITTAUER</b> , Nagelzangen	569	<b>MAYO-ADAMS</b> , selbsthaltende Wundsperrer	296
<b>LITTAUER-LISTON</b> , Knochensplitterzangen	477	<b>MAYO-HARRINGTON</b> , Scheren	105
<b>LITTLE</b> , Wundhaken	263	<b>MAYO-HEGAR</b> , Hartmetallnadelhalter TUC	192
<b>LITTLER</b> , feine Scheren	123	<b>MAYO-HEGAR</b> , Nadelhalter	184
<b>LITTLEWOOD</b> , Darmfasszange	518	<b>MAYO-HEGAR-DELICATE</b> , Hartmetallnadelhalter TUC	192
<b>LLOYD-DAVIS</b> , Anastomosenklemmen	529	<b>MAYO-HEGAR-DELICATE</b> , Nadelhalter	184
<b>LOCKHART-MUMMERY</b> , Sonden	311	<b>MAYO-NOBLE</b> , Scheren	105
<b>LOCKLIN</b> , Hartmetallscheren TUC	162	<b>MAYO-ROBSON</b> , Magen- und Darmklemmen	521, 526
<b>LOCKLIN</b> , Zahnfleischscheren	136	<b>MAYO-RUSS.</b> , Fasspinzetten	66
<b>LOCKWOOD</b> , Fasszangen	518	<b>MAYO-STILLE</b> , Hartmetallscheren TUC	154
<b>LOCKWOOD-ALLIS</b> , Fasszange	518	<b>MAYO-STILLE</b> , Scheren	105
<b>LONDON-COLLEGE</b> , Zahnpinzetten	95	<b>MC GIVNEY</b> , Hämorrhoidal-Ligatoren	553
<b>LONG</b> , Hysterektomieklemmen	44	<b>MC INDOE</b> , Knochensplitterzangen	478
<b>LORENZ</b> , Verbandscheren	133	<b>MC INDOE</b> , Pinzetten	60
<b>LORNA</b> , Tuchklemme	52	<b>MC INDOE</b> , Scheren	118
<b>LOTH-KLINKENBERGH</b> , Gefäßscheren	117	<b>MC INTOSH FIBRE OPTIC</b> , Laryngoskope	357
<b>LOTH-SCHOEMAKER</b> , Ligaturscheren	128	<b>MC INTOSH</b> , Laryngoskope	353
<b>LOUTE</b> , Drahtspanninstrumente	407	<b>McDONALD</b> , Elevatorien	448
<b>LOVELACE-DIXON</b> , Arterienklemmen	26	<b>McDONALD</b> , Kapsulorhexispinzette	90
<b>LOWER</b> , Gallenkanalklemmen	37	<b>McPHERSON</b> , Nahtpinzetten	85
<b>LUCAE</b> , Hämmer	430	<b>McPHERSON-KELMAN</b> , Nahtpinzetten	85
<b>LUCAE</b> , Nasenpinzetten	77	<b>MEAD</b> , Hämmer	430
<b>LUCAS</b> , Meißel	417	<b>MEAD</b> , Hohlmeißelzangen	469
<b>LUCAS</b> , scharfe Löffel	441	<b>MEEKER</b> , Präparier- und Ligaturklemmen	25
<b>LUER</b> , Hämorrhoidenklemmen, atraumatisch	48	Meißel	417-426
<b>LUER</b> , Hohlmeißelzangen	469	<b>MENGHINI</b> , Biopsiekanülen	344
<b>LUER</b> , Saugrohre	336	Meniskotome	467
<b>LUETHY-BECK</b> , Hartmetallnadelhalter TUC	202	Meniskus- und Knorpelfasszangen	453
Luft Bohraparat	391	Meniskushaken	466
Lungenlappenscheren	118	<b>MERIAM</b> , Zahnpinzetten	96
		Messapparate, Blutdruck-	379
<b>M</b>		Messbecher	556, 559
Magen- und Darmklemmen	520-523	Messer, Abszess-	174
Magen- und Darmquetschklemmen	530	Messer, Amputations-	172
Magenklemmen	531	Messer, Fistel-	174
<b>MAGILL</b> , Katheterzangen	361	Messer, Gips-	318
<b>MAJER-SIMS</b> , Kornzangen	239	Messer, Hirn-	173
		Messer, Organ-	173

	Seite		Seite
Messer, Transplantations-	175	<b>MOORFIELD</b> , Nahtpinzetten	84
Messinstrumente	371-375	<b>MORGAN</b> , Anuskope	541
<b>METZENBAUM</b> , Hartmetallnadelhalter TUC	199	<b>MORGAN</b> , Kaltlicht	541
<b>METZENBAUM</b> , Hartmetallscheren TUC	155, 156	<b>MORRIS</b> , Wundhaken	261
<b>METZENBAUM</b> , Präparierscheren	108	<b>MOSQUITO-HALSTED</b> , Arterienklemmen	15
<b>METZENBAUM-BABY</b> , Präparierscheren	108	<b>MOSQUITO-MICRO</b> , Arterienklemmen	15
<b>METZENBAUM-DELICATE</b> , Hartmetallscheren TUC	158-160	<b>MOYNIHAN</b> , Hysterektomieklappen	44
<b>METZENBAUM-DELICATE</b> , Präparierscheren	110	<b>MUMMERY-LOCKHART</b> , Sonden	311
<b>METZENBAUM-NELSON</b> , Präparierscheren	109	Muskelpinzetten	87, 88
<b>MEYERDING</b> , feine Wundhaken	247	<b>MYRTLE-LEAF</b> , Sonden	310
<b>MEYERDING</b> , selbsthaltende Wundsperrerr	294		
<b>MEYERDING</b> , Wundhaken	273	<b>N</b>	
<b>MEYERDING-MARKHAM</b> , selbsthaltende Wundsperrerr	294	<b>NABATOFF</b> , Krampfaderbesteck	312
<b>MICHEL</b> , Wundklammern	225	Nabelschnurscheren	121
<b>MICHEL</b> , Wundklammerpinzetten	224	Nachstarscheren	139
<b>MICHEL</b> , Wundklammerzängchen	224	Nadelhalter	180-213
<b>MICRO-ADSON</b> , Pinzetten	59	Nadelhalter, Boomerang-	189
<b>MICRO-FRIEDMAN</b> , Hohlmeißelzange	476	Nadelhalter, Hartmetall TUC-	192-205
<b>MICRO-MOSQUITO</b> , Arterienklemmen	15	Nadelhalter, Mikro-	204-213
<b>MICRO-RYDER</b> , Hartmetallnadelhalter TUC	193	Nadeln, Führungs-	346
<b>MICROVASCULAR</b> , Hartmetallnadelhalter TUC	193	Nadeln, <b>REVERDIN</b>	214
<b>MICRO-WULLSTEIN</b> , Saugrohre	335	Nadeln, Unterbindungs-	215-219
<b>MIDDELDORPF</b> , Wundhaken	264	Nadel-Sterilisierkästen	560
Mikronadelhalter	204-213	Nägel	492-498
Mikronadelhalter mit Rundgriff	206-209	Nagelfeilen	579
Mikropinzetten	71, 72	Nagelscheren	135
Mikroscheren	143-149	Nagelspaltscheren	135
Mikroscheren, Adventitia	145, 147	Nagelzangen	568-570
Mikroscheren, Dissection	145, 147	<b>NAGER</b> , Unterbindungsnadeln	219
Mikroscheren, Nerve	147	Naht	180-225
<b>MIKULICZ</b> , Peritoneumklemmen	49	Nahtpinzetten	85, 86
<b>MIKULICZ</b> , Wundhaken	268	Nahtpinzetten	97
<b>MIKULICZ-BABY</b> , Peritoneumklemmen	49	Narkose	353-363
<b>MILLER FIBRE OPTIC</b> , Laryngoskope	359	Nasen- und Ohrpinzetten	77, 78
<b>MILLER</b> , Artikulationspapierpinzette	98	Nasenscheren	119, 120
<b>MILLER</b> , Laryngoskope	355	<b>NEFF</b> , Meniskotome	467
<b>MILLER-SENN</b> , feine Wundhaken	250	<b>NEGUS</b> , Gallenkanalklemmen	40
<b>MILLIGAN</b> , selbsthaltende Wundsperrerr	288	<b>NEIVERT</b> , Hartmetallnadelhalter TUC	195
<b>MILLS</b> , Gefäßschere	116	<b>NEIVERT</b> , Nadelhalter	181
<b>MINI</b> , Skalpellgriffe	167	<b>NELATON</b> , Sonden	310
<b>MINI</b> , Skalpellklingen	167	<b>NELSON</b> , Fasspinzetten	66
<b>MINI-FRIEDMAN</b> , Hohlmeißelzangen	468	<b>NELSON</b> , Trokare	328
<b>MINI-HOHMANN</b> , Knochenhebel	395	<b>NELSON-METZENBAUM</b> , Präparierscheren	109
<b>MINI-LAMBOTTE</b> , Osteotome	426	<b>NERVE</b> , Mikroscheren	147
<b>MINI-LANGENBECK</b> , feine Wundhaken	247	Nerv-Präparierscheren	111
<b>MINI-LEXER</b> , Meißel	422	<b>NEUMANN</b> , Zahnfleischscheren	137
<b>MINI-LEXER</b> , Osteotome	422	Neurochirurgiescheren	115-117
<b>MISKIMON</b> , selbsthaltende Wundsperrerr	289	<b>NEW ORLEANS</b> , Hartmetallnadelhalter TUC	194
<b>MIXTER</b> , Chirurgische Scheren	104	<b>NEW ORLEANS</b> , Nadelhalter	183
<b>MIXTER</b> , Präparier- und Ligaturklemmen	33, 34	Nierenschalen	559
<b>MIXTER-BABY</b> , Präparier- und Ligaturklemmen	33	Nierenstielklemmen	37-39
<b>MIXTER-O'SHAUGNESSY</b> , Präparier- und Ligaturklemmen	33	<b>NIRO</b> , Drahtzangen	401
<b>MIXTER-OVERHOLT</b> , Präparier- und Ligaturklemmen	29	<b>NOBLE-MAYO</b> , Scheren	105
<b>MOD. BONN</b> , feine Scheren	124	<b>nopa PROFI</b> , Autopsie-Säge	484
<b>MOD. BONN</b> , Irispinzetten	81	<b>NORTHBENT</b> , Ligaturscheren	129
<b>MOD. BONN</b> , Nahtpinzetten	86	<b>NOTO</b> , Schwammzangen	234
<b>MOD. TÜBINGEN</b> , Nahtpinzetten	86	<b>NOYES</b> , Iridektomiescheren	138
<b>MOD. TÜBINGEN-VANNAS</b> , Nachstarscheren	139	<b>NUSSBAUM</b> , Magen- und Darmklemmen	523
<b>MOD. USA</b> , Gipsspreizer	319		
<b>MOD. USA</b> , Nabelschnurscheren	121	<b>O</b>	
<b>MOD. USA/SMITH</b> , Verbandscheren	133	<b>O'BRIAN</b> , feine Scheren	124
<b>MOD. WIEN</b> , Nahtinstrumente	223	<b>OBWEGESER</b> , Ramushaken	257
<b>MODELL TÜBINGEN</b> , Wundhaken	262	<b>OBWEGESER</b> , Weichteilhaken	255, 256
<b>MODELL USA</b> , Pinzetten	59	<b>OCHSNER</b> , Trokare	329
<b>MOELTGEN</b> , Goniometer	373	<b>OCHSNER-KOCHER</b> , Arterienklemmen	20, 21
<b>MOLDESTAD</b> , feine Wundhaken	244	<b>O'CONNOR</b> , feine Wundhaken	243
<b>MOLLISON</b> , selbsthaltende Wundsperrerr	289	<b>O'CONNOR-O'SULLIVAN</b> , Bauchdeckenhalter	301
<b>MOLT</b> , Raspatorien	444		
<b>MOORE</b> , Handbohrapparate	387		



	Seite		Seite
<b>OEHLER</b> , Hartmetallpinzetten TUC	92	Pinzetten, Mikro-	71, 72
Ohr- und Nasenpinzetten	77, 78	Pinzetten, Muskel-	87
<b>OLIVECRONA</b> , Gefäßscheren	117	Pinzetten, Naht-	85, 86
<b>OLLIER</b> , Wundhaken	253	Pinzetten, Ohr- und Nasen	77, 78
<b>OLSEN-HEGAR</b> , Hartmetallnadelhalter TUC	198	Pinzetten, Splitter-	73-75
<b>OLSEN-HEGAR</b> , Nadelhalter	185	Pinzetten, Tampon-	78
<b>OLSEN-HEGAR-USA</b> , Hartmetallnadelhalter TUC	198	Pinzetten, Uhrmacher-	69
<b>OMBREDANNE</b> , Hämmer	427	Pinzetten, Wundklammer-	224, 225
Operations-Skalpelle	169-171	Pinzetten, Zahn-	95-97
Optischer Retraktor	281, 282	<b>PLESTER</b> , Saugrohre	335
Organmesser	173	<b>PLESTER</b> , selbsthaltende Wundsperrer	295
<b>OSCINOPA</b> , Autopsie-Säge	483	<b>POOLE</b> , Saugrohre	332
<b>OSCINOPA</b> , elektrische Gipsäge	321	<b>POOLE-BABY</b> , Saugrohre	332
Osteotome	417-426	<b>POTTS-DE MARTEL</b> , Gefäßscheren	116
<b>O'SULLIVAN-O'CONNOR</b> , Bauchdeckenhalter	301	<b>POTTS-SMITH</b> , Gefäßscheren	113, 115
<b>OTOSKOP UNI</b> , Diagnostikbesteck	381	<b>POTTS-SMITH</b> , Hartmetallmikronadelhalter TUC	205
<b>OVERHOLT</b> , Präparier- und Ligaturklemmen	24	<b>POTTS-SMITH</b> , Hartmetallpinzetten TUC	92
<b>OVERHOLT-BABY</b> , Präparier- und Ligaturklemme	23	<b>POTTS-SMITH</b> , Hartmetallscheren TUC	157
<b>OVERHOLT-GEISSENDOERFER</b> , Präparier- und Ligaturklemmen	23	<b>POTTS-SMITH</b> , Mikronadelhalter	212
<b>OVERHOLT-MIXTER</b> , Präparier- und Ligaturklemmen	29	<b>POTTS-SMITH</b> , Pinzetten	63
		<b>POTTS-SMITH</b> , Scheren	118
<b>P</b>		Präparier- und Ligaturklemmen	23-25, 29, 31-36
<b>PALMER</b> , Nägel	496	Präparierscheren	108-112
<b>PARAMETRIUM</b> , Hartmetallscheren TUC	154	<b>PRATT</b> , Fistelsonden	311
<b>PARAMETRIUM</b> , Parametriumklemmen	46	<b>PRATT</b> , Hämorrhoidenklemmen	47
Parametriumklemmen	46	<b>PRATT</b> , Mastdarm-Spekula	536
<b>PARKER</b> , Wundhaken	278	<b>PRECISA</b> , Blutdruckmessapparate	379
<b>PARKER-LANGENBECK</b> , Wundhaken	278	<b>PRESBYTERIAN</b> , Schlauchklemmen	53
<b>PARTSCH</b> , Hämmer	430	<b>PRINCE</b> , Muskelpinzetten	87
<b>PARTSCH</b> , Meißel	418	<b>PRINCE</b> , Tonsillenscheren	119
<b>PATON</b> , Mikronadelhalter	212	Proktoskope	537-543
<b>PAUFIQUE</b> , Nahtpinzetten	86	<b>PROVIDENCE-HOSPITAL</b> , Arterienklemmen	16
<b>PAYR</b> , Darm- und Magenquetschklemmen	530	Punktion/Kanülen	327-349
<b>PAYR</b> , Führungshohlsonden	221	<b>PUTTI</b> , Raspeln	451
<b>PAYR-BABY</b> , Darm- und Magenquetschklemmen	530	<b>PYE-SMITH (HARRISON)</b> , Sterilisierzangen	564
<b>PAYR-SCHMIEDEN</b> , Führungshohlsonden	221	<b>PYNCHON-ANDREWS</b> , Saugrohre	331
<b>PEAN</b> , Faszangen	13		
<b>PEAN-DELICATE</b> , Arterienklemmen	22	<b>Q</b>	
<b>PEAN-ROCHESTER</b> , Arterienklemmen	18, 19	<b>QUINBY</b> , Zahnfleischscheren	137
<b>PEERS</b> , Tuchklemmen	52	<b>QUINKE</b> , Biopsiekanülen	344
<b>PEET</b> , Splitterpinzetten	75		
<b>PELKMANN</b> , Tupperzangen	235	<b>R</b>	
<b>PENNINGTON</b> , Faszangen	13	<b>RABINER</b> , Perkussionshammer	369
<b>PERCY</b> , Amputationsschild	463	<b>RADOLF</b> , Nagelzangen	482
Peritoneumklemmen	49, 50	<b>RAGNELL-DAVIS</b> , feine Wundhaken	250
Perkussionshämmer	369, 370	<b>RAGNELL-KILNER</b> , Präparierscheren	112
<b>PERRY</b> , Zahnpinzetten	97	<b>RALK</b> , Handbohrapparate	389
<b>PERTHES</b> , Handbohrapparate	390	<b>RALK</b> , Splitterpinzetten	75
<b>PHANEUF</b> , Hysterektomieklammern	45	<b>RAMPLEY</b> , Schwammzangen	238
<b>PHILIPS</b> , Schraubenzieher	491	Ramushaken	257
<b>PIERCE</b> , Trokare	330	<b>RANKIN-CRILE</b> , Arterienklemmen	17
<b>PIFFARD</b> , scharfe Löffel	436	<b>RANKIN-KELLY</b> , Arterienklemmen	17
<b>PINARD</b> , Stethoskope	377	Rasierklingen	177
Pinzetten	57-98	Raspatorien	442-446
Pinzetten, anatomisch	57-65	Raspeln	451
Pinzetten, Artikulationspapier-	98	<b>REHN</b> , Transplantationsmesser	175
Pinzetten, Chalazion-	88, 89	<b>REILL</b> , Mikronadelhalter	207
Pinzetten, chirurgisch	57-65, 67, 68	<b>REINER</b> , Gipsmesser	318
Pinzetten, Cilien-	76	Reinigungsbürsten	583-589
Pinzetten, Deckglas-	78	Reinigungspistole	590, 591
Pinzetten, Entropium-	88	Rektoskope	544-550
Pinzetten, Fass-	66-68, 70, 316	Repositionszangen	487
Pinzetten, Fixier-	84	<b>RESANO</b> , Atraumatische Magen- und Darmklemmen	527
Pinzetten, Hartmetall TUC	92-94	Resektions- und Amputationssägen	384
Pinzetten, Iris-	79-82	<b>REVERDIN</b> , Bauchspatel	308
Pinzetten, Kapsel-	83	<b>REVERDIN</b> -Nadeln	214
Pinzetten, Knüpf- mit Plateau	71, 72	<b>REYNOLDS</b> , Präparierscheren	112
Pinzetten, Markierungs-	98		

	Seite		Seite
<b>REZAK-HEANEY</b> , Hysterektomieklemmen	44	Scheren, Chirurgische-	102-105, 122
<b>RIBBON</b> , Augenscheren	127	Scheren, Darm-	118
<b>RICARD</b> , Bauchdeckenhalter	306	Scheren, Draht-	130
<b>RICHARDSON-EASTMAN</b> , Wundhaken	264	Scheren, Episiotomie-	121
<b>RICHARDSON-KELLY</b> , Wundhaken	264	Scheren, fein	122-124
<b>RICHTER</b> , Chirurgische Scheren	104	Scheren, Gefäßchirurgie-	113-117
<b>RICHTER-HEATH</b> , Wundklammerzängchen	224	Scheren, Gips-	134
<b>RIGHBY</b> , selbsthaltende Wundsperrerr	295	Scheren, Gynäkologisch	105-107
<b>RIRAP</b> , Stethoskop	378	Scheren, Hartmetall TUC	152-162
<b>RISCOPE S</b> , Ophthalmoskop	381	Scheren, Haut-	135
<b>RISCOPE S</b> , Oto-/Ophthalmoskop	380	Scheren, Hornhaut-	141-143
<b>ROBERTS</b> , Arterienklemmen	30	Scheren, Iridektomie-	138
<b>ROBIN-MASSE</b> , Bauchdeckenhalter	306	Scheren, Kapsulotomie	140
<b>ROCHESTER-CARMALT</b> , Arterienklemmen	27	Scheren, Kleider-	132, 133
<b>ROCHESTER-PEAN</b> , Arterienklemmen	18, 19	Scheren, Knorpel-	118
<b>ROEDER</b> , Tuchklemmen	52	Scheren, Kronen-	130, 131
<b>ROETTGEN-RUSKIN</b> , Hohlmeißelzangen	473	Scheren, Kropf-	119
<b>ROGGE</b> , Sterilisierzangen	564	Scheren, Ligatur-	128, 129
<b>ROLLET</b> , feine Wundhaken	246	Scheren, Lungenlappen-	118
<b>ROSCHKE</b> , Anuskop	537	Scheren, Mikro-	143-149
<b>ROSSEGGER-KIJMA</b> , Biopsiekanülen	343	Scheren, Nabelschnur	121
<b>ROTTER</b> , Unterbindungsnadeln	219	Scheren, Nachstar-	139
<b>ROUX</b> , Wundhaken	277	Scheren, Nagel-	135
<b>ROWE</b> , Repositionszange	487	Scheren, Nagelspalt-	135
<b>RUDD</b> , Hämorrhoidal-Ligatoren	554	Scheren, Nasen-	119, 120
<b>RUMEL</b> , Präparier- und Ligaturklemmen	31	Scheren, Neurochirurgie-	115-117
Runde Schalen	559	Scheren, Präparier-	108-112
<b>RUSKIN</b> , Hohlmeißelzangen	471, 475	Scheren, Sehnen-	126, 140
<b>RUSKIN-LISTON</b> , Knochensplittierzangen	478	Scheren, Strabismus-	126
<b>RUSKIN-MINI</b> , Hohlmeißelzangen	471	Scheren, Supercut SC	101
<b>RUSS. MODELL</b> , Fasspinzetten	68	Scheren, Tonsillen-	119
<b>RUSS.-MAYO</b> , Fasspinzetten	66	Scheren, Verband-	132-134
<b>RYDER-FRENCH-EYE</b> , Hartmetallnadelhalter TUC	193	Scheren, Zahnfleisch-	136, 137
<b>RYDER-LANGENBECK</b> , Hartmetallnadelhalter TUC	202	Schieblehre	372, 373
<b>RYDER-MATHIEU VASCULAR</b> , Hartmetallnadelhalter TUC	200	<b>SCHINDLER</b> , Peritoneumklemme	50
<b>RYDER-MATHIEU</b> , Hartmetallnadelhalter TUC	200	<b>SCHINK</b> , Dermatome	176
<b>RYDER-MICRO</b> , Hartmetallnadelhalter TUC	193	Schlauchklemmen	53
<b>S</b>		<b>SCHMID</b> , Spezialkanülen	345
Säge, Gips-	318	<b>SCHMIEDEN</b> , Unterbindungsnadeln	217
Sägeblätter für elektrische Gipssägen	323	<b>SCHMIEDEN-PAYR</b> , Führungshohlsonden	221
Sägen	384, 482-485	<b>SCHMIEDEN-TAYLOR</b> , Gefäßscheren	116
<b>SALAH</b> , Biopsiekanülen	343	<b>SCHNIDT-SAWTELL</b> , Tonsillenklemmen	27
<b>SALENIUS</b> , Meniskotome	467	<b>SCHOEMAKER</b> , Kropfscheren	119
<b>SAMII</b> , Pinzetten	70	<b>SCHOEMAKER-LOTH</b> , Ligaturscheren	128
<b>SANVENERO</b> , Präparierscheren	112	Schraubenzieher	491
<b>SAROT</b> , Bronchusklemmen	30	<b>SCHUHKNECHT</b> , selbsthaltende Wundsperrerr	289
<b>SAROT</b> , Hartmetallnadelhalter TUC	197	<b>SCHUKNECHT</b> , Drahtscheren	130
<b>SAROT</b> , Nadelhalter	183	<b>SCHULZE-BERGMANN</b> , Mastdarm-Spekula	535
<b>SATINSKY</b> , Gefäßscheren	117	<b>SCHUMACHER</b> , Nabelschnurscheren	121
<b>SATTERLEE</b> , Amputationssägen	384	Schutzzange	390
<b>SATTLER</b> , Muskelpinzetten	87	Schwammzangen	228-239
<b>SAUERBRUCH</b> , Hohlmeißelzangen	474	<b>SCHWECKENDICK-GOOD</b> , Tonsillenscheren	119
<b>SAUERBRUCH</b> , Wundhaken	260, 274	<b>SCUDDER</b> , Atraumatische Magen- und Darmklemmen	526
Saugrohre	503	<b>SCUDDER</b> , Magen- und Darmklemmen	523, 526
Saugrohre	331-337	<b>SEBILEAU</b> , Elevatorien	447
<b>SAWTELL-SCHNIDT</b> , Tonsillenklemmen	27	<b>SEDILLOT</b> , Raspatorien	445
<b>SAWYER</b> , Mastdarm-Spekula	534	<b>SEGOND</b> , Hysterektomieklemmen	45
<b>SCALP-CONTOUR</b> , selbsthaltende Wundsperrerr	294	<b>SEGOND-LANDAU</b> , Hysterektomieklemmen	45
<b>SCHAEDEL</b> , Tuchklemmen	51	Sehnenfassinstrumente	464
Schalen	559, 561, 562	Sehnenfächer	126, 140
<b>SCHANZ</b> , Bohrdrähte	503	Sehnenstripper	465
Scharfe Löffel	434-441	Selbsthaltende Wundsperrerr	283, 284, 287-297
<b>SCHUDE</b> , scharfe Löffel	435	<b>SELLORS-CRAFOORD</b> , Aurikelklemmen	29
Scheren	102-162	<b>SEMB</b> , Hohlmeißelzangen	472
Scheren, Anatomie-	118	<b>SEMB</b> , Knochenhalte-zangen	456
Scheren, Augen-	125-127, 138-143	<b>SEMB</b> , Knochensplittierzangen	480
Scheren, Bauchdecken-	106	<b>SEMB</b> , Raspatorien	446
		<b>SEMKEN</b> , Hartmetallpinzetten TUC	92
		<b>SEMKEN</b> , Pinzetten	60, 61



	Seite		Seite
<b>SEMM</b> , Bauchdeckenhalter	303	<b>STELLBRINK</b> , Hohlmeißelzangen	468
<b>SENN-GREEN</b> , feine Wundhaken	247	Sterilisierklammern	564
<b>SENNING (SCHWED. MODELL)</b> , Hartmetallnadelhalter TUC	194	Sterilisierzangen	564
<b>SENNING (SCHWED. MODELL)</b> , Nadelhalter	183	<b>STERNUM</b> , Drahtzangen TUC	403
<b>SENN-MILLER</b> , feine Wundhaken	250	<b>STERNUM</b> , Hartmetalldrahtzangen TUC	203
<b>SENN-MILLER-BABY</b> , feine Wundhaken	250	Stethoskope	377, 378
Sensibilitätsinstrumente	376	<b>STEVENS</b> , Hartmetallschere TUC	161
<b>SEUTIN</b> , Verbandschere	134	<b>STEVENS</b> , Irispinzetten	80
<b>SHORTBENT</b> , Ligaturschere	129	<b>STEVENS</b> , Mikronadelhalter	212
<b>SIEBOLD</b> , Gynäkologische Scheren	107	<b>STEVENS</b> , Sehnenschere	126
<b>SIMON</b> , Fistelmesser	174	<b>STIEGLITZ</b> , Splitterpinzetten	75
<b>SIMON</b> , Wundhaken	262	<b>STILLE</b> , Gipsschere	320
<b>SIMS</b> , Gynäkologische Scheren	107	<b>STILLE</b> , Handbohrapparate	386
<b>SIMS</b> , Hartmetallschere TUC	155	<b>STILLE</b> , Hohlmeißelzangen	472
<b>SIMS</b> , Mastdarm-Spekula	534	<b>STILLE</b> , Meißel	421
<b>SIMS-MAIER</b> , Kornzangen	239	<b>STILLE</b> , Nierenstielklammern	38
<b>SINGLEY-TUTTLE</b> , Fasspinzetten	66	<b>STILLE</b> , Osteotome	421
<b>SINUSCOPY</b> , Trokare	327	<b>STILLE</b> , Pinzetten	65
Skalpelle	165-177	<b>STILLE-BARRAYA</b> , Pinzetten	65
Skalpellgriffe	165-167	<b>STILLE-DOYEN</b> , Wundhaken	266
Skalpellschlingen	167, 168	<b>STILLE-LISTON</b> , Knochensplitterzangen	479
<b>SMILLIE</b> , Meniskotome	467	<b>STILLE-LUER</b> , Hohlmeißelzangen	473
<b>SMILLIE</b> , Meniskushaken	466	<b>STILLE-MAYO</b> , Hartmetallschere TUC	154
<b>SMITH</b> , Drahtschere	130	<b>STILLE-MAYO</b> , Schere	105
<b>SMITH-BUIE</b> , Mastdarm-Spekula	536	<b>STILLE-RUSKIN</b> , Hohlmeißelzangen	472
<b>SMITH-FERRIS</b> , Pinzetten	65	<b>STILLE-SHERMAN</b> , Handbohrapparate	385
<b>SMITH-HEYWOOD</b> , Schwammzangen	236	Stimlampen	368
<b>SMITH-MODELL USA</b> , Verbandschere	133	Stirnspiegel	367
<b>SMITH-PETERSEN</b> , Meißel	419	Stößel	451
<b>SMITH-PETERSEN</b> , Osteotome	419	Strabismusschere	126
<b>SMITH-PETERSON</b> , Hohlmeißelzangen	475	<b>STRATTE</b> , Hartmetallnadelhalter TUC	197
<b>SMITH-POTTS</b> , Gefäßschere	113, 115	<b>STRATTE</b> , Nadelhalter	185
<b>SMITH-POTTS</b> , Hartmetallmikronadelhalter TUC	205	<b>STRAUSS</b> , Rektoskope	548
<b>SMITH-POTTS</b> , Hartmetallpinzetten TUC	92	<b>STRULLY</b> , Gefäßschere	115
<b>SMITH-POTTS</b> , Mikronadelhalter	212	<b>SULLIVAN</b> , Zahnfleischschere	137
<b>SMITH-POTTS</b> , Pinzetten	63	<b>SULLIVAN-BROPHY</b> , feine Schere	123
<b>SMITH-POTTS</b> , Schere	118	Super Cut Schere	101
<b>SNELLEN</b> , Entropiumpinzette	88	<b>SYME</b> , Unterbindungsnaht	216
<b>SNITMAN</b> , selbsthaltende Wundsperrer	284		
Sonden	310, 311	<b>T</b>	
Sonden, Führungshohl-	220-222	Tablett	561
Spatel, Bauch-	308	Tamponpinzetten	78
<b>SPENCER</b> , Ligaturschere	128	<b>TAYLOR</b> , Knochenheber	398
<b>SPENCER-DELICATE</b> , Ligaturschere	128	<b>TAYLOR</b> , Perkussionshammer	369
<b>SPENCER-WELLS</b> , Arterienklammern	14	<b>TAYLOR</b> , Pinzetten	61
Sphinkteroskope, Anusko, Proktoskope	537-541	<b>TAYLOR</b> , Spinalhaken	250
Spiegel, Stim-	367	<b>TAYLOR-CUSHING</b> , Hartmetallpinzetten TUC	93
Spinalhaken	250	<b>TAYLOR-SCHMIEDEN</b> , Gefäßschere	116
Spirituslampen	556	<b>TERRIER</b> , Arterienklemme	14
Splitterpinzetten	73-75	<b>TERSON</b> , Irispinzetten	83
<b>SPRATT</b> , scharfe Löffel	435	<b>THIERSCH</b> , Transplantationsmesser	175
Spreizer, Gips-	319	<b>THIESS</b> , Hämmer	430
Spritzen	348	<b>THOMS-ALLIS</b> , Fasszangen	518
Spülschalen	562	<b>THOREK</b> , Präparierschere	111
<b>ST. MARKS</b> , Wundhaken	275	<b>THORPE</b> , Schieblehre	372
<b>ST. MARTIN</b> , Nahtpinzetten	85	<b>TOENNIS</b> , Gefäßschere	116
<b>STACKE</b> , Sonden	310	<b>TOENNIS</b> , Hartmetallnadelhalter TUC	201
<b>STADLER-BRAUN</b> , Episiotomieschere	121	<b>TOENNIS</b> , Nadelhalter	188
<b>STANDARD</b> , anatomische Pinzetten	57	<b>TOENNIS</b> , Präparier- und Ligaturklammern	36
<b>STANDARD</b> , chirurgische Pinzetten	57	<b>TOENNIS-ADSON</b> , Gefäßschere	116
<b>STANDARD</b> , Chirurgische Schere	102	<b>TOENNIS-ADSON-DELICATE</b> , Hartmetallschere TUC	161
<b>STANDARD</b> , Hartmetallschere TUC	152, 153	<b>TOHOKU-JAPAN</b> , Tuchklammern	52
<b>STANDARD</b> , Trokare	327	Tonsillenklammern	27
<b>STANDARD</b> , Zahnfleischschere	137	Tonsillenschere	119
Standgefäße	562	<b>TOWNLEY</b> , Schieblehre	372
Stechbecken	563	Transplantationsmesser	175
<b>STEINBACH</b> , Hämmer	432	<b>TRAVERS</b> , selbsthaltende Wundsperrer	288
<b>STEINMANN</b> , Knochnägel	399, 497, 498	<b>TRELAT</b> , Unterbindungsnaht	218
<b>STEINMANN</b> , Sehnenfassinstrumente	464		

	Seite		Seite
Trephine, Gips-	318	<b>WALTON</b> , Kornzangen	239
<b>TROCAR</b> , Biopsiekanülen	344	<b>WALTON</b> , selbsthaltende Wundsperrer	297
<b>TROELTSCH-WILDE</b> , Ohrpinzetten	77	<b>WALTON-LISTON</b> , Knochensplitterzangen	478
<b>TROEMNER</b> , Perkussionshammer	370	<b>WALTON-YANKAUER</b> , Saugrohre	331
Trokare	327-330	<b>WANGENSTEEN</b> , Hartmetallnadelhalter TUC	197
<b>TROUTMAN (CORNEAL)</b> , Irispinzetten	82	<b>WANGENSTEEN</b> , Hartmetallpinzetten TUC	94
<b>TROUTMAN</b> , Hornhautscheren	141	<b>WANGENSTEEN</b> , Nadelhalter	185
<b>TROUTMAN</b> , Mikronadelhalter	207	<b>WANGENSTEEN</b> , Pinzetten	65
<b>TROUTMAN-BARRAQUER</b> , Mikronadelhalter	206	<b>WANGENSTEEN-DELICATE</b> , Nadelhalter	185
<b>TROUTMAN-CHRIS</b> , Klängenbrecher	177	<b>WARTENBERG</b> , Sensibilitätsinstrumente	376
<b>TÜBINGEN MOD.</b> , Nahtpinzetten	86	<b>WATSON</b> , Dermatome	176
<b>TÜBINGEN MODELL</b> , Wundhaken	262	Watteträger	311, 312
<b>TÜBINGER MODELL</b> , selbsthaltende Wundsperrer	296	<b>WAUGH</b> , Fasspinzette	67
Tuchklappen	51, 52	<b>WEBSTER</b> , Hartmetallnadelhalter TUC	195
<b>TUDOR-EDWARDS</b> , Knochensplitterzangen	479	<b>WEBSTER</b> , Nadelhalter	181
<b>TUFFIER</b> , Bauchspatel	308	<b>WECKER</b> , Indektomieschere	138
<b>TUFFIER</b> , Fasszangen	12	Weichteilhaken	255, 256
<b>TUFFIER</b> , Wundhaken	267	<b>WEITLANER</b> , selbsthaltende Wundsperrer	287
<b>TUOHY</b> , Biopsiekanülen	344	<b>WEITLANER-BABY</b> , selbsthaltende Wundsperrer	287
Tupferzangen	229-239	<b>WELLS-SPENCER</b> , Arterienklappen	14
<b>TURNBULL</b> , Nagelzangen	568	<b>WERTHEIM</b> , Hartmetallnadelhalter TUC	198
<b>TUTTLE-SINGLEY</b> , Fasspinzetten	66	<b>WERTHEIM</b> , Hysterektomieklappen	41, 42
		<b>WERTHEIM</b> , Nadelhalter	185
<b>U</b>		<b>WERTHEIM</b> , Scheren	106
		<b>WERTHEIM-CULLEN</b> , Hysterektomieklappen	44
<b>UCKERMANN</b> , Watteträger	312	<b>WESTCOTT</b> , Mikroschere	143
Uhrmacherpinzetten	69	<b>WESTCOTT</b> , Sehnenschere	140
<b>ULRICH</b> , Knochenhalte-zangen	462	<b>WESTERMARK</b> , Tupferzangen	232
<b>ULRICH</b> , Kornzangen	229	<b>WIGMORE</b> , Gipsmesser	318
<b>UNIVERSAL</b> , Drahtschere	130	<b>WIKSTROEM</b> , Präparier- und Ligaturklappen	41
<b>UNIVERSAL</b> , Handbohrapparate	389	<b>WILDBERG</b> , Klappen	496
<b>UNIVERSAL</b> , Hartmetallschere TUC	162	<b>WILDE-TROELTSCH</b> , Ohrpinzetten	77
<b>UNIVERSAL</b> , Hohlmeißelzangen	468	<b>WILLET-MARTEL</b> , Kopfhautklappen	12
<b>UNIVERSAL</b> , Trokare	327	<b>WILLIAMS</b> , Fasszangen	518
<b>UNIVERSAL</b> , Verbandschere	132	<b>WILLIGER</b> , Elevatorien	447
Universalretraktor	282	<b>WILLIGER</b> , Hämmer	428
Unterbindungsnadeln	215-219	<b>WILLIGER</b> , Raspatorien	444
Urinale	563	<b>WILLIGER</b> , scharfe Löffel	440
		<b>WILMER</b> , Augenschere	126
<b>V</b>		<b>WOLFF</b> , Gipsabreisszange	320
		<b>WULLSTEIN MICRO</b> , Saugrohre	335
<b>VACUNOPA</b> , Vakuumsauger	324	<b>WULLSTEIN</b> , selbsthaltende Wundsperrer	289
<b>VAN BUREN</b> , Knochenhalte-zangen	452	Wund- und Meniskushaken	466
<b>VANNAS MOD. TÜBINGEN</b> , Nachstarschere	139	Wundhaken	242-308
<b>VANNAS</b> , Nachstarschere	139	Wundhaken mit Kaltlichtbeleuchtung	281
Verband	318-324	Wundhaken, fein	242-250
Verbandschere	132-134	Wundklappen	225
Verbindungsstücke	349	Wundklammerpinzetten	224, 225
<b>VERBRUGGE</b> , Knochenhalte-zangen	459	Wundklammerzängen	224
<b>VERNET-GIL</b> , feine Wundhaken	249	Wundsperrer, selbsthaltend	283, 284, 287-297
<b>VERNIER</b> , Schieblehre	372, 373	Wundspreizer für die Handchirurgie	285
<b>VERRES</b> , Spezialkanülen	345		
<b>VIRCHOW</b> , Hirnmesser	173	<b>Y</b>	
<b>WISE</b> , Knüpfpinzetten mit Plateau	71		
<b>VOLKMANN</b> , scharfe Löffel	434, 440	<b>YANCOSKIE</b> , Abdominoplastikretraktor	280
<b>VOLKMANN</b> , Wundhaken	251, 252	<b>YANKAUER</b> , Saugrohre	331
Vorbohrer für Knochenschrauben	513	<b>YANKAUER-WALTON</b> , Saugrohre	331
Vorderkammerpinzetten	85	<b>YEOMAN</b> , Mastdarm-Biopsiezangen	551
		<b>YOUNG-HRYNTSCHAK</b> , Nadelhalter	189
<b>W</b>			
		<b>Z</b>	
<b>WACHENFELDT</b> , Wundklammerpinzetten	224		
<b>WAGNER</b> , feine Schere	122	Zahnfleischschere	136, 137
<b>WALB</b> , Organmesser	173	Zahnpinzetten	95-97
<b>WALDMANN</b> , Episiotomieschere	121	Zängen, Wundklammer-	224
<b>WALTER</b> , Wundhaken	250	Zangen, Draht- mit Hartmetalleinsätzen TUC	203
<b>WALTER-CARMALT</b> , Splitterpinzetten	73	Zangen, Gipsabreiss-	320
<b>WALTON</b> , feine Schere	124	Zangen, Korn-	229-239
<b>WALTON</b> , Fingerringssägen	482	Zangen, Schwamm-	228-239

Zangen, Tupfer-	229-239
<b>ZAUFAL-JANSEN</b> , Hohlmeißelzangen	471
<b>ZENKER</b> , Präparier- und Ligaturklemmen	32
<b>ZENKER</b> , Wundhaken	272
<b>ZIEGLER</b> , Cilienpinzetten	76
Zubehör für Bohrapparate	392
Zubehör für Haken-Marknägel	490
<b>ZWEIFEL</b> , Hartmetallnadelhalter TUC	202
<b>ZWEIFEL</b> , Nadelhalter	187





# Index

	Page		Page
<b>A</b>		<b>AYER</b> , chalazion forceps	88
Abdominal, retractors	298-307	<b>B</b>	
Abdominal, scissors	106	<b>BABCOCK</b> , intestinal tissue forceps	519
Abdominal, spatulas	308	<b>BABCOCK</b> , tissue seizing forceps	9
Abscess knives	174	<b>BABINSKY</b> , percussion hammers	369
Accessories for drills	392	<b>BABY KOCHER</b> , Non-traumatic stomach and intestinal forceps	526
Accessories for intramedullary pins with hook	490	<b>BABY-ADSON</b> , ligature and dissecting forceps	25
Accu power drill	391	<b>BABY-ADSON</b> , selfretaining retractors	292
<b>ADAMS-MAYO</b> , selfretaining retractors	296	<b>BABY-BALFOUR</b> , abdominal retractors	299
<b>ADISON</b> , protecting forceps	390	<b>BABY-COLLIN</b> , abdominal retractors	304
<b>ADLERKREUTZ</b> , tissue forceps	65	<b>BABY-CRILE-WOOD</b> , needle holders	182
<b>ADSON</b> , dissecting and ligature forceps	25	<b>BABY-CRILE-WOOD</b> , needle holders tungsten TUC	196
<b>ADSON</b> , dissecting forceps tungsten TUC	93	<b>BABY-DOYEN</b> , stomach and intestinal clamp forceps	520
<b>ADSON</b> , dressing forceps	59, 60	<b>BABY-KOCHER</b> , stomach and intestinal clamp forceps	521, 526
<b>ADSON</b> , elevators	449	<b>BABY-LEXER</b> , scissors	111
<b>ADSON</b> , needle holders	183	<b>BABY-LIGHTWEIGHT-DUPLEX</b> , stethoscopes	378
<b>ADSON</b> , selfretaining retractors	290, 291	<b>BABY-METZENBAUM</b> , scissors	108
<b>ADSON</b> , suction tubes	335	<b>BABY-MIKULICZ</b> , peritoneal clamp forceps	49
<b>ADSON-ANDERSON</b> , selfretaining retractors	290	<b>BABY-MIXTER</b> , dissecting and ligature forceps	33
<b>ADSON-BABY</b> , dissecting and ligature forceps	25	<b>BABY-OVERHOLT</b> , dissecting and ligature forceps	23
<b>ADSON-BABY</b> , selfretaining retractors	292	<b>BABY-POOLE</b> , suction tubes	332
<b>ADSON-BECKMANN</b> , selfretaining retractors	293	<b>BABY-SENN-MILLER</b> , delicate retractors	250
<b>ADSON-BROWN</b> , tissue forceps	60	<b>BABY-WEITLANER</b> , selfretaining retractors	287
<b>ADSON-MICRO</b> , dressing and tissue forceps	59	<b>BACKHAUS</b> , towel forceps	52
<b>ADSON-TOENNIS</b> , scissors	116	<b>BACON</b> , bone rongeurs	470
<b>ADSON-TOENNIS-DELICATE</b> , scissors tungsten TUC	161	<b>BAINBRIDGE</b> , artery forceps	27
<b>Adventitia</b> , micro scissors	145, 147	<b>BAINBRIDGE</b> , Non-traumatic stomach and intestinal clamp forceps	524
Air power drill	391	<b>BALFOUR US-TYPE</b> , abdominal retractors	299
<b>ALAN PARKS</b> , anoscopes	537	<b>BALFOUR</b> , abdominal retractors	299, 300
Alcohol burners	556	<b>BALFOUR-BABY</b> , abdominal retractors	299
<b>ALDERDYCE</b> , elevators	448	<b>BALL &amp; SOCKET</b> , towel forceps	52
<b>ALEXANDER</b> , chisels	418	<b>BALLANTINE-HEANEY</b> , hysterectomy forceps	43
<b>ALEXANDER</b> , raspatories	446	<b>BALLENGER-FOERSTER</b> , sponge holding forceps	237
<b>ALLIS</b> , tissue seizing forceps	9	Bandage scissors	132-134
<b>ALLIS</b> , tissue seizing forceps	517	<b>BARRAQUER</b> , anterior chamber forceps	85
<b>ALLIS-ADAIR</b> , tissue seizing forceps	517	<b>BARRAQUER</b> , cilia forceps	76
<b>ALLIS-BABY</b> , tissue seizing forceps	517	<b>BARRAQUER</b> , iris scissors	138
<b>ALM</b> , selfretaining retractors	283	<b>BARRAQUER</b> , needle holders	206
<b>ALY</b> , sensibility instruments	376	<b>BARRAQUER-KATZIN (COLIBRI)</b> , iris forceps	82
Amputating and resection saws	384	<b>BARRAQUER-KATZIN</b> , corneal scissors	142
Amputating knives	172	<b>BARRAQUER-TROUTMAN</b> , micro needle holders	206
Amputation shield	463	<b>BARRAYA-STILLE</b> , tissue forceps	65
Anaesthesia	353-363	Battery / Charger	393
Anastomosis clamps forceps	528, 529, 532, 533	<b>BAUMGARTNER</b> , needle holders	184
<b>ANDERSON-ADSON</b> , selfretaining retractors	290	<b>BECK-LUETHY</b> , needle holders tungsten TUC	202
<b>ANDREWS-PYNCHON</b> , suction tubes	331	<b>BECKMANN</b> , selfretaining retractors	292
Angiotribses	47, 48	<b>BECKMANN-ADSON</b> , selfretaining retractors	293
Anoscopes	537-543	<b>BECKMANN-EATON</b> , selfretaining retractors	293
Anterior chamber forceps	85	Bed pans	563
<b>ANVIL</b> , nail splitting forceps	571	<b>BEEBEE</b> , crown scissors	130, 131
<b>ARLT-FISCHER</b> , iris forceps	80	<b>BEER</b> , cilia forceps	76
<b>ARRUGA</b> , capsular forceps	83	<b>BEESON</b> , plaster cast spreader	319
<b>ARRUGA</b> , micro needle holder	212	<b>BENGOLEA</b> , artery forceps	28
<b>ARRUGA</b> , needle holder	180	<b>BENSAUDE</b> , anoscopes	540
<b>ARRUGA</b> , needle holder tungsten TUC	201	<b>BERENS</b> , muscular forceps	88
<b>ARRUGA-KALT</b> , micro needle holder	212	<b>BERGMANN</b> , bandage scissors	132
Artery forceps	13-23, 25-28	<b>BERGMANN</b> , mallets	427
Artery forceps, delicate	22	<b>BERGMANN</b> , plaster saw	318
Arthroscopy	408-415	<b>BERKE</b> , chalazion forceps	89
Articulating paper forceps	98	<b>BERLINER</b> , percussion hammers	370
Auricle forceps	29	<b>BERNHARD</b> , towel forceps	51
<b>AUSTIN</b> , tying forceps	71	<b>BEYER</b> , bone rongeurs	471
<b>AUSTRALIA</b> , finger retractor	283	<b>BILLROTH</b> , retractors	252
<b>AUSTRALIA</b> , hand surgery retractors	285		

	Page		Page
<b>BINKHORST</b> , capsular forceps	83	<b>C</b>	
Biopsy needles	343, 344	<b>CAIRNS</b> , artery forceps	22
<b>BIRCHER</b> , meniscotomy knives	467	Caliper	372, 373
<b>BIRCHER-GANSKE</b> , bone holding forceps	453	<b>CAMBELL</b> , trocars	328
<b>BIRKETT</b> , dissecting and ligature forceps	41	<b>CANNY RYALL</b> , retractors	279
<b>BISHOP-HARMAN</b> , iris forceps	82	<b>CAPLAN</b> , nasal scissors	119
Blade breakers	177	Capsular forceps	83
<b>BLASCOVICS</b> , muscular forceps	87	Capsulorhexis forceps	90
<b>BLOND</b> , anoscopes	542, 543	Capsulotomy scissors	140
Blood pressure manometers	379	<b>CARDINALE</b> , scissors	107
Blood vessel clamps	12	<b>CARDINALE</b> , scissors tungsten TUC	155
<b>BLOUNT</b> , bone levers	398	<b>CARDIOPHON</b> , stethoscope	378
<b>BLOUNT</b> , knee retractors	466	<b>CARMALT-ROCHESTER</b> , artery forceps	27
<b>BLUEPOWER</b> , electric plaster saw	322	<b>CARMALT-WALTER</b> , splinter forceps	73
<b>BLUMENTHAL</b> , bone rongeurs	469	<b>CAROLL</b> , goniometers	373
<b>BÖHLER</b> , bone rongeurs	471	<b>CAROLL</b> , tendon seizing instruments	464
<b>BÖHLER</b> , extension bows	399	<b>CARREL</b> , artery forceps	14
<b>BOLEY</b> , caliper	373	<b>CARROLL</b> , needle holders	182
<b>BONACCOLTO</b> , suture forceps	85	<b>CARROLL</b> , needle holders tungsten TUC	194
Bone curettes	434-441	Cartilage scissors	118
Bone Cutting Forceps	477-480	<b>CARTILAGE-MARTIN</b> , scissors	118
Bone files	450	Cartridge syringes	347
Bone holding clamps	394	<b>CASTROVIEJO</b> , blade breakers	177
Bone holding forceps	452, 454-462	<b>CASTROVIEJO</b> , capsular forceps	83
Bone levers	395-398	<b>CASTROVIEJO</b> , circle	375
Bone Rongeurs	468-476	<b>CASTROVIEJO</b> , circle	375
Bone Screws	505-512	<b>CASTROVIEJO</b> , corneal section scissors	141
<b>BONNEY</b> , dissecting forceps tungsten TUC	94	<b>CASTROVIEJO</b> , fixation forceps	84
<b>BONNEY</b> , grasping forceps	68	<b>CASTROVIEJO</b> , iris scissors	138
Boomerang needle holders	189	<b>CASTROVIEJO</b> , micro needle holders	210, 213
<b>BÖTTCHER</b> , tonsil scissors	119	<b>CASTROVIEJO</b> , micro needle holders tungsten TUC	204, 205
Bowls	559, 561, 562	<b>CASTROVIEJO</b> , suture forceps	85
<b>BOYNTON</b> , needle holders	180	<b>CASTROVIEJO-EPKER</b> , circle	375
<b>BOYNTON</b> , needle holders tungsten TUC	201	<b>CASTROVIEJO-KALT</b> , micro needle holders	212
<b>BOYS-ALLIS</b> , tissue seizing forceps	518	Catheter forceps	360
<b>BOZEMANN</b> , dressing forceps	233	<b>CATLIN</b> , amputating knives	172
<b>BOZEMANN</b> , ligature instruments	223	<b>CHADWICK</b> , eye scissors	126
<b>BOZEMANN</b> , needle holders	182	Chalazion forceps	88, 89
<b>BOZEMANN</b> , needle holders tungsten TUC	197	<b>CHAPUT</b> , seizing forceps	12
<b>BOZEMANN-DOUGLAS</b> , dressing forceps	233	Charger / Battery	394
Brain knives	173	<b>CHARRIERE</b> , amputating saws	384
<b>BRAND</b> , tendon seizing instruments	464	<b>CHEATLE</b> , sterilizing forceps	564
<b>BRAUN-STADLER</b> , episiotomy scissors	121	<b>CHERON</b> , dressing forceps	234
<b>BRIDGE</b> , dissecting and ligature forceps	34	<b>CHILDE</b> , suture forceps	225
<b>BRODIE</b> , probes	311	Chisels	417-426
Bronchus forceps	30	<b>CHRIS-TROUTMAN</b> , blade breakers	177
<b>BROPHY (SULLIVAN)</b> , fine scissors	123	<b>CHURCH</b> , scissors	117
<b>BROPHY</b> , dressing and tissue forceps	63	Cilia forceps	76
<b>BROWN</b> , needle holders	183	Clamps, tubing	53
<b>BROWN</b> , tissue forceps	64	<b>CLAR 55</b> , head lamps	368
<b>BROWN-ADSON</b> , tissue forceps	60	<b>CLAR STANDARD</b> , head lamps	368
<b>BROWNE-DENIS</b> , abdominal retractors	301	<b>CLASSON</b> , scissors	117
<b>BRUNNER</b> , ligature conductors	220	<b>CLAUS</b> , ligature needles	218
<b>BRUNNER</b> , ligature needles	216, 217	<b>CLAUS-EICKEN</b> , ligature needles	219
<b>BRUNNER</b> , retractors	263	Cleaning brushes	583-589
<b>BRUNNER</b> , stomach and intestinal clamp forceps	520	<b>CLEVELAND</b> , bone cutting forceps	478
<b>BRUNNER-FERROZELL</b> , ligature conductors	222	<b>CLEVELAND</b> , bone rongeurs	468
<b>BRUNS</b> , bone curettes	434, 437	<b>CLEVELAND-GARDNER</b> , bone cutting forceps	477
<b>BRUNS</b> , plaster-of-Paris shears	134	Clips	496
<b>BRYANT</b> , sponge holding forceps	228	Clips, suture	225
<b>BUCK</b> , ligature scissors	129	Clothing scissors	132, 133
<b>BUCK</b> , percussion hammers	369	<b>CLOWARD HIBBS SPRATT</b> , bone curettes	437
<b>BUELAU</b> , trocars	328	<b>COAKLEY</b> , trocars	330
Bulldog Clamps	10, 11	<b>COBB</b> , bone curettes	439
<b>BUNNELL</b> , hand drills	388	<b>COBB</b> , chisels	424
<b>BUNNELL</b> , tendon stripper	465	<b>COBB</b> , elevators	449
<b>BUSCH</b> , umbilical scissors	121	<b>COGSWELL</b> , suction tubes	336
<b>BYRD</b> , suction tubes	332	<b>COLIBRI (BARRAQUER-KATZIN)</b> , iris forceps	82



	Page		Page
<b>COLLER</b> , artery forceps	17	<b>DAHMEN</b> , osteotomes	425
<b>COLLIER</b> , needle holders	180	<b>DANDY</b> , scalp flap forceps	26
<b>COLLIN</b> , abdominal retractors	304, 305	<b>DANDY</b> , scissors	115
<b>COLLIN</b> , amputating knives	172	<b>DARLING</b> , selfretaining retractors	295
<b>COLLIN</b> , dressing forceps	234	<b>DAVIDSON</b> , retractors	276
<b>COLLIN</b> , dynamometers	374	<b>DAVIS-RAGNELL</b> , delicate retractors	250
<b>COLLIN</b> , mallets	429	<b>DE BAKEY (MAYO-HEGAR-DELICATE)</b> , needle holders TUC	192
<b>COLLIN</b> , operating knives	170	<b>DE BAKEY</b> , dissecting forceps tungsten TUC	94
<b>COLLIN</b> , scalpel handles	166	<b>DE BAKEY</b> , non-traumatic tissue forceps	91
<b>COLLIN</b> , seizing forceps	13	<b>DE BAKEY</b> , scissors	113, 116
<b>COLLIN</b> , suture forceps	224	<b>DE BAKEY</b> , scissors tungsten TUC	157
<b>COLLIN-BABY</b> , abdominal retractors	304	<b>DE BAKEY</b> , suction tubes	331
<b>COLLIN-DUVAL</b> , grasping forceps	66	<b>DE BAKEY</b> , vascular dilators	314
<b>COLLIN-HARTMANN</b> , retractors	277	<b>DE LA ROZA</b> , ligature needles	217
Comb	564	<b>DE MARTEL-POTTS</b> , scissors	116
Conductors, ligature	220-222	<b>DE MARTEL-WOLFSON</b> , anastomosis clamps	532, 533
<b>CONE</b> , selfretaining retractors	292	<b>DE MARTEL-WOLFSON</b> , intestinal clamp forceps	532, 533
Connecting pieces	349	<b>DEAN</b> , gum scissors	136
<b>CONVERSE</b> , needle holders tungsten TUC	195	<b>DEAN</b> , scissors tungsten TUC	162
<b>CONVERSE-DERF</b> , needle holders	180	<b>DEAN-DELICATE</b> , gum scissors	136
<b>COOLEY</b> , suction tubes	333	<b>DEAVER</b> , operating scissors	104
<b>COOLEY</b> , vascular dilators	313	<b>DEAVER</b> , retractors	269-271
<b>COOPER</b> , ligature needles	216	<b>DEJERINE</b> , percussion hammers	370
<b>CORNEAL (TROUTMAN)</b> , iris forceps	82	Delicate artery forceps	22
Corneal scissors	141-143	Delicate hooks	242-250
Corneal section scissors	142	Delicate retractors	250
Coronary scissors	115	<b>DEMEL</b> , wire twisting instruments	407
<b>CORWIN</b> , wire forceps TUC	403	<b>DENIS-BROWNE</b> , abdominal retractors	301
<b>CORWIN</b> , wire twisting forceps tungsten TUC	203	<b>DERF</b> , needle holders	180
<b>CORYLLOS</b> , retractors	274	<b>DERF</b> , needle holders tungsten TUC	195
<b>COTTLE KAZANJIAN</b> , bone cutting forceps	477	<b>DERF-CONVERSE</b> , needle holders	180
<b>COTTLE</b> , mallets	428	Dermatomes	176
<b>COTTLE</b> , nasal scissors	120	<b>DESCHAMPS</b> , needles	215
<b>COTTLE</b> , nose dressing forceps	77	<b>DESJARDINS</b> , gall duct forceps	40
Cotton and dressing pliers	95-97	<b>DESMARRES</b> , chalazion forceps	88
Cotton applicators	311, 312	<b>DESMARRES</b> , delicate retractors	248
<b>COUPLAND</b> , suction tubes	332	Diagnostic Sets	380, 381
<b>COUPLAND</b> , suction tubes	337	Diagnostics	367-382
Cover glass forceps	78	<b>DICK</b> , anastomosis forceps	528
<b>CRAFOORD</b> , bronchus forceps	30	<b>DIEFFENBACH</b> , abscess knives	174
<b>CRAFOORD</b> , scissors	118	<b>DIEFFENBACH</b> , bulldog clamps	11
<b>CRAFOORD-SELLORS</b> , auricle forceps	29	<b>DIEFFENBACH</b> , operating knives	170, 171
<b>CRANE-KAPLAN</b> , pocket markers	98	<b>DIETRICH</b> , micro needle holders tungsten TUC	205
<b>CREGO</b> , bone levers	398	<b>DIETRICH-HEGEMANN</b> , scissors	114
<b>CRILE</b> , artery forceps	17	Dilators, vascular	313, 314
<b>CRILE</b> , needle holders	187	<b>DINGMANN</b> , cartilage forceps	453
<b>CRILE-MURRAY</b> , needle holders	182	<b>DIPLOMAT</b> , blood pressure manometers	379
<b>CRILE-RANKIN</b> , artery forceps	17	Dissecting, ligature forceps	23-25, 29, 31-36
<b>CRILE-WOOD</b> , needle holders	182	Dissecting, scissors	108-112
<b>CRILE-WOOD</b> , needle holders tungsten TUC	196	<b>Dissection</b> , micro scissors	145, 147
<b>CRILE-WOOD-BABY</b> , needle holders	182	<b>DIXON-LOVELACE</b> , artery forceps	26
<b>CRILE-WOOD-BABY</b> , needle holders tungsten TUC	196	<b>DOUGLAS</b> , cilia forceps	76
Crown scissors	130, 131	<b>DOUGLAS</b> , trocars	330
<b>CULLEN-WERTHEIM</b> , hysterectomy forceps	44	<b>DOUGLAS-BOZEMANN</b> , dressing forceps	233
Curettes	434-441	<b>DOYEN</b> , abdominal retractors	302
<b>CUSHING</b> , delicate hooks	244	<b>DOYEN</b> , mallets	428
<b>CUSHING</b> , delicate retractors	248	<b>DOYEN</b> , needle holders	180
<b>CUSHING</b> , dissecting forceps tungsten TUC	93	<b>DOYEN</b> , Non-traumatic stomach and intestinal forceps	524
<b>CUSHING</b> , dressing and tissue forceps	62	<b>DOYEN</b> , probes	310
<b>CUSHING</b> , flat drill	387	<b>DOYEN</b> , raspatories	445
<b>CUSHING</b> , spinal retractors	250	<b>DOYEN</b> , retractors	267
<b>CUSHING-TAYLOR</b> , dissecting forceps tungsten TUC	93	<b>DOYEN</b> , scissors	106
Cuticle scissors	135	<b>DOYEN</b> , stomach and intestinal clamp forceps	520, 524
<b>CZERNY</b> , rectal specula	534	<b>DOYEN</b> , towel forceps	51
<b>CZERNY</b> , retractors	279	<b>DOYEN-STILLE</b> , retractors	266
<b>D</b>		Dressing	318-324
<b>DAHMEN</b> , chisels	425	Dressing and tampon forceps	78
		Dressing forceps	57-65, 229-239
		Drill bit for bone screws	513

	Page		Page
<b>DUBOIS</b> , scissors	107	Fine scissors	122-124
<b>DUEHRSSSEN</b> , dressing and tissue forceps	64	Finger retractor	283
<b>DUNHILL</b> , artery forceps	22	Finger ring saws	482
<b>DUPLAY</b> , polypus forceps	236	<b>FINOCCHIETTO</b> , kidney pedicle clamp forceps	37
<b>DUPLEX-LIGHTWEIGHT/BABY</b> , stethoscopes	378	<b>FINOCCHIETTO</b> , needle holders	185
<b>DURANTE</b> , grasping forceps	68	<b>FINOCCHIETTO</b> , needle holders tungsten TUC	197
<b>DUVAL</b> , grasping forceps	68	<b>FINOCCHIETTO</b> , scissors	118
<b>DUVAL</b> , intestinal tissue forceps	519	<b>FINSEN</b> , selfretaining retractors	283
<b>DUVAL-COLLIN</b> , grasping forceps	66	<b>FISCHER-ARLT</b> , iris forceps	80
Dynamometer	374	Fistula knives	174
<b>DYNAMOMETER III</b>	374	Fistula scissors	106
<b>E</b>		Fixation forceps	84
Ear dressing forceps	77	<b>FLAGG</b> , cotton and dressing pliers	96
<b>EASTMAN-RICHARDSON</b> , retractors	264	Flat nose pliers	404
<b>EATON-BECKMANN</b> , selfretaining retractors	293	<b>FLETCHER</b> , sponge holding forceps	232
<b>ECHLIN</b> , bone rongeurs	474	<b>FOERSTER</b> , iris forceps	81
<b>ECONOM</b> , diagnostic sets	380	<b>FOERSTER-BALLENGER</b> , sponge holding forceps	237
<b>EICKEN</b> , trocars	330	<b>FOMON</b> , dissecting scissors	111
<b>EICKEN-CLAUS</b> , ligature needles	219	<b>FOMON</b> , nasal scissors	119
<b>EICKEN-KILLIAN</b> , suction tubes	335	Forceps	57-98
<b>EISELSBERG</b> , ligature scissors	128	Forceps, anterior chamber	85
Elevators	447-449, 481	Forceps, artery	13-23, 25-28
<b>ELSCHNIG</b> , fixation forceps	84	Forceps, articulating paper	98
<b>ENGEL</b> , plaster saw	318	Forceps, auricle	29
<b>ENGL. MODELL</b> , towel forceps	51	Forceps, bronchus	30
Enterotomy scissors	118	Forceps, capsular	83
Entropium forceps	88	Forceps, catheter	360
Episiotomy scissors	121	Forceps, chalazion	88, 89
<b>ERHARDT</b> , entropium forceps	88	Forceps, cilia	76
<b>ESMARCH</b> , bandage scissors	134	Forceps, cotton and dressing pliers	95-97
<b>ESMARCH</b> , plaster knives	318	Forceps, cover glass	78
<b>EUFRATE-PASQUE</b> , microvascular needle holders TUC	193	Forceps, dissecting and ligature	23-25, 29, 31-36
<b>EWALD</b> , dressing and tissue forceps	60	Forceps, dressing	57-65, 229-239
<b>EXCENTRIC-LISTER</b> , bandage scissors	133	Forceps, ear and nose dressing	77
Extension bows	399, 400	Forceps, entropium	88
Eye scissors	125-127, 138-143	Forceps, fixation	84
<b>F</b>		Forceps, grasping	66-68, 70, 316
Facelift markers	376	Forceps, haemorrhoidal	47, 48
Face-lift scissors TUC	161	Forceps, haemorrhoidal atraumatic	48
<b>FALK</b> , ligature needles	219	Forceps, hysterectomy	41-45
<b>FARABEUF</b> , bone holding forceps	458	Forceps, iris	79-82
<b>FARABEUF</b> , raspatories	443	Forceps, jeweler's	69
<b>FARABEUF</b> , retractors	278	Forceps, kidney pedicle clamp	37-39
<b>FARABEUF-LAMBOTTE</b> , bone holding forceps	458	Forceps, muscular	87, 88
<b>FARREL</b> , cotton applicators	311	Forceps, non-traumatic vascular tissue	91
<b>FAULKNER</b> , lens holding forceps	90	Forceps, parametrium	46
<b>FAURE</b> , hysterectomy forceps	45	Forceps, peritoneal clamp	49, 50
<b>FAURE</b> , peritoneal clamp forceps	50	Forceps, plaster cast bending	320
<b>FAVALORO</b> , scissors	115	Forceps, polypus	229-239
<b>FEHLAND</b> , stomach and intestinal clamp forceps	527	Forceps, seizing	12, 13
<b>FEILCHENFELD</b> , splinter forceps	73	Forceps, setting	11
<b>FEIN</b> , cotton applicators	312	Forceps, splinter	73-75
<b>FERGUSON</b> , angiotribs	47	Forceps, sponge holding	228-239
<b>FERGUSON</b> , bone holding forceps	455	Forceps, suture	85, 86, 224, 225
<b>FERGUSON</b> , operating scissors	104	Forceps, tampon	78
<b>FERGUSON</b> , suction tubes	335	Forceps, tissue	57-65, 67, 68
<b>FERREIRA</b> , retractors	280	Forceps, tissue seizing	9
<b>FERRIS-SMITH</b> , tissue forceps	65	Forceps, tonsil hemostatic	27
<b>FERROZELL</b> , ligature conductors	222	Forceps, towel	51, 52
<b>FERROZELL-BRUNNER</b> , ligature conductors	222	Forceps, tungsten TUC	92-94
<b>FERROZELL-KIRSCHNER</b> , ligature conductors	222	Forceps, wire twisting tungsten TUC	203
Fibre optic laryngoscopes	357-360	<b>FOREGGER (WISCONSIN) FIBRE OPTIC</b> , laryngoscopes	358
<b>FIBRE OPTIC</b> , fibre optic laryngoscopes	360	<b>FOREGGER (WISCONSIN)</b> , laryngoscopes	354
Fibre optic carriers	363	<b>FOX</b> , bone curettes	436
Fine artery forceps	15	<b>FOX-GOLDMAN (SPECIAL)</b> , gum scissors	136
		<b>FOX-GOLDMAN</b> , gum scissors	136
		<b>FOX-GOLDMAN</b> , scissors tungsten TUC	161
		Fracture pins	496



	Page		Page
<b>FRANKENFELDT</b> , grasping forceps	316	<b>HALLE</b> , nasal scissors	120
<b>FRANZ</b> , abdominal retractors	302	<b>HALSEY</b> , needle holders	181
<b>FRAZIER</b> , delicate hooks	242	<b>HALSEY</b> , needle holders tungsten TUC	195
<b>FRAZIER</b> , suction tubes	335	<b>HALSTED</b> , artery forceps	16
<b>FREER</b> , elevators	448	<b>HALSTED-MOSQUITO</b> , artery forceps	15
<b>FRENCH-EYE/Ryder</b> , needle holders tungsten TUC	193	Hammers, percussion	369, 370
<b>FRIEDMAN</b> , bone rongeurs	468	Hand Drills	385-390
<b>FRIEDRICH</b> , ligature instruments	223	Hand surgery retractors	285
<b>FRITSCH</b> , retractors	266	Handles for Liposuction and infiltration cannulae	338, 340
<b>FRYKHOLM</b> , bone rongeurs	474	<b>HARMAN-BISHOP</b> , iris forceps	82
<b>FUCHS-GILL</b> , iris forceps	83	<b>HARMS</b> , suture forceps	86
<b>FULTON</b> , scissors	117	<b>HARRINGTON</b> , retractors	267
<b>G</b>			
Gall duct forceps	37, 40	<b>HARRISON (PYE-SMITH)</b> , sterilizing forceps	564
<b>GARRETT</b> , vascular dilators	313	<b>HARTMANN</b> , artery forceps	14
<b>GEISSENDOERFER-OVERHOLT</b> , dissecting and ligature forceps	23	<b>HARTMANN</b> , bone rongeurs	469
<b>GELPI</b> , selfretaining retractors	294	<b>HARVEY</b> , wire cutting scissors	130
<b>GEMINI</b> , dissecting and ligature forceps	35	<b>HATFIELD</b> , bone curettes	439
<b>GERALD</b> , dissecting and tissue forceps	62	Head lamps	368
<b>GERSTER</b> , bone holding clamps	394	Head mirrors	367
<b>GERSTER-LOWMAN</b> , bone holding clamps	394	<b>HEANEY</b> , hysterectomy forceps	43
<b>GILL</b> , Capsular forceps	83	<b>HEANEY</b> , needle holders	184
<b>GILL-FUCHS</b> , iris forceps	83	<b>HEANEY</b> , retractors	277
<b>GILL-HESS</b> , iris forceps	82	<b>HEANEY-BALLANTINE</b> , hysterectomy forceps	43
<b>GILLIES</b> , delicate hooks	242	<b>HEANEY-KANTER</b> , hysterectomy forceps	43
<b>GILLIES</b> , dissecting forceps tungsten TUC	92	<b>HEANEY-REZAK</b> , hysterectomy forceps	44
<b>GILLIES</b> , needle holders	185	<b>HEATH</b> , ligature scissors	129
<b>GILLIES</b> , needle holders tungsten TUC	198	<b>HEATH-RICHTER</b> , suture forceps	224
<b>GILLIES</b> , tissue forceps	67	<b>HEGAR-MAYO</b> , needle holders	184
<b>GILLS-WELSH</b> , capsulotomy scissors	140	<b>HEGAR-MAYO</b> , needle holders tungsten TUC	192
<b>GIL-VERNET</b> , delicate retractors	249	<b>HEGAR-MAYO-DELICATE (DE BAKEY)</b> , needle holders TUC	192
<b>GOELET</b> , retractors	279	<b>HEGAR-MAYO-DELICATE</b> , needle holders	184
Goitre enucleation scissors	119	<b>HEGAR-OLSEN</b> , needle holders	185
<b>GOLDMAN-FOX (SPECIAL)</b> , gum scissors	136	<b>HEGAR-OLSEN</b> , needle holders tungsten TUC	198
<b>GOLDMAN-FOX</b> , gum scissors	136	<b>HEGEMANN-DIETRICH</b> , scissors	114
<b>GOLDMAN-FOX</b> , scissors tungsten TUC	161	<b>HEGENBARTH</b> , suture forceps	224
Goniometers	373	<b>HEIFETZ</b> , grasping forceps	70
<b>GOOD</b> , tonsil scissors	119	<b>HEISS</b> , artery forceps	30
<b>GOOD-SCHWECKENDICK</b> , tonsil scissors	119	<b>HELPERICH-BIER</b> , amputating saws	384
<b>GORNEY</b> , dissecting scissors	111	<b>HEMINGWAY</b> , bone curettes	441
<b>GOSSET</b> , abdominal retractors	298	<b>HENAHAN</b> , thir molar hook	481
<b>GRADLE</b> , cilia forceps	76	Hemostats	9-53
Graduated Measures	556, 559	<b>HENLEY</b> , selfretaining retractors	288
<b>GRAEFE</b> , delicate hooks	243	<b>HENNIG</b> , plaster cast spreader	319
<b>GRAEFE</b> , eye scissors	126	<b>HERRICK</b> , kidney pedicle clamp forceps	39
<b>GRAEFE</b> , fixation forceps	84	<b>HESS</b> , iris forceps	81
<b>GRAEFE</b> , iris forceps	79	<b>HESSBERG</b> , ligature needles	217
Grasping forceps	66-68, 70, 316	<b>HESS-GILL</b> , iris forceps	82
<b>GRAY</b> , gall duct forceps	40	<b>HEYMANN</b> , nasal scissors	120
<b>GRAZIL</b> , operating scissors	103	<b>HEYWOOD-SMITH</b> , sponge holding forceps	236
<b>GREEN</b> , fixation forceps	84	<b>HIBBS</b> , chisels	420
<b>GREEN-SENN</b> , delicate retractors	247	<b>HIBBS</b> , osteotomes	420
<b>GROSS-MAIER</b> , polypus forceps	230, 231	<b>HIRSCHMANN</b> , anoscopes	539
<b>GRUENWALD (JANSEN)</b> , nose dressing forceps	78	<b>HOEN</b> , elevators	448
<b>GRUENWALD</b> , nose dressing forceps	78	<b>HOESEL</b> , needle holders	188
Guide needles	346	<b>HOESEL</b> , needle holders tungsten TUC	201
Gum scissors	136, 137	<b>HOESEL</b> , retractors	265
<b>GUTHRIE</b> , delicate hooks	246	<b>HOHMANN</b> , bone levers	396, 397
<b>GUYON</b> , kidney pedicle clamp forceps	38, 39	<b>HOKE</b> , osteotomes	417
<b>GUYON-ARTRAUMATIC</b> , kidney pedicle clamp forceps	39	<b>HOLINGER</b> , laryngoscopes	362
Gynecological scissors	105-107	Hooks, delicate	242-250
<b>H</b>			
<b>HABERER</b> , abdominal spatulas	308	<b>HOPKINS</b> , plaster knives	318
Haemorrhoidal ligators	552-554	<b>HOPKINS-JOHNS</b> , bulldog clamps	11
<b>HAJEK</b> , maillets	429	<b>HOPKINS-JOHNS</b> , dissecting and ligature forceps	32
		<b>HOPKINS-JOHNS</b> , setting forceps	11
		<b>HORNE-JOBSON</b> , cotton applicators	312
		<b>HOSPITAL-PROVIDENCE</b> , artery forceps	16
		<b>HRYNTSCHAK-YOUNG</b> , boomerang needle holders	189
		<b>HUDSON</b> , hand drills	387
		<b>HUMBY</b> , dermatomes	176

	Page		Page
<b>HUNT</b> , grasping forceps	70	<b>KELLY</b> , proctoscopes	540, 541
<b>HUNTER</b> , splinter forceps	73	<b>KELLY</b> , retractors	268
<b>HURD</b> , ligature needles	218	<b>KELLY</b> , scissors	106
Hysterectomy forceps	41-45	<b>KELLY</b> , scissors tungsten TUC	153
<b>I</b>		<b>KELLY</b> , sponge holding forceps	235
Incision scissors	104	<b>KELLY-RANKIN</b> , artery forceps	17
Instrument boxes	562	<b>KELMAN-McPHERSON</b> , suture forceps	85
Instrument Storing Tray	561	<b>KERN</b> , bone holding forceps	456
Instruments for Küntscher nails	488, 489	<b>KERSTING</b> , anastomosis forceps	528
Intestinal and anastomosis clamp forceps	532, 533	Kidney pedicle clamp forceps	37-39
Intestinal and stomach clamp forceps	520-523	Kidney tray	559
Intestinal and stomach crushing clamps	530	<b>KILNER (RAGNELL)</b> , scissors	112
Intramedullary pins	495	<b>KILNER</b> , delicate hooks	242
<b>IOWA</b> , special needles	345	<b>KILNER</b> , needle holders	181
Iridectomy scissors	138	<b>KILNER</b> , needle holders tungsten TUC	195
Iris forceps	79-82	<b>KIRBY</b> , iris forceps	82
Iris scissors	125, 138	<b>KIRSCHNER</b> , abdominal retractors	303
<b>ISRAEL</b> , retractors	253	<b>KIRSCHNER</b> , extension bows	400
<b>IVES-FANSLER</b> , sphincteroscopes	538	<b>KIRSCHNER</b> , ligature conductors	222
<b>IWANSON</b> , circle	375	<b>KIRSCHNER</b> , suction tubes	503
<b>J</b>		<b>KIRSCHNER</b> , wires	499-502
<b>JACKSON</b> , fibre optic laryngoscopes	363	<b>KIRSCHNER-FERROZELL</b> , ligature conductors	222
<b>JACKSON</b> , tampon forceps	78	<b>KLEINERT-KUTZ</b> , bone rongeurs	471
<b>JACOBI</b> , ligature needles	217	<b>KLEINERT-KUTZ</b> , delicate hooks	242
<b>JACOBS CHUCK</b> , hand drills	388	<b>KLEINERT-KUTZ</b> , tendon seizing instruments	464
<b>JACOBSON</b> , micro needle holders	210	<b>KLIMA-ROSSEGGER</b> , biopsy needles	343
<b>JACOBSON</b> , micro needle holders tungsten TUC	204	<b>KLINIKUM BERLIN</b> , tubing clamps	53
<b>JACOBSON</b> , needle holders	182	<b>KLINKENBERGH-LOTH</b> , scissors	117
<b>JACOBSON</b> , needle holders tungsten TUC	194	<b>KNAPP</b> , delicate hooks	246
<b>JAMESON</b> , caliper	372	Knee retractors	466
<b>JAMESON</b> , muscular forceps	87	<b>KNIGHTON</b> , selfretaining retractors	297
<b>JAMESON</b> , needle holders	184	Knives, abscess	174
<b>JANET</b> , syringes	348	Knives, amputating	172
<b>JANSEN</b> , bone curettes	440	Knives, brain	173
<b>JANSEN</b> , nose dressing forceps	77	Knives, fistula	174
<b>JANSEN</b> , self-retaining retractors	284	Knives, operating	169-171
<b>JANSEN-GRUENWALD</b> , nose dressing forceps	78	Knives, plaster	318
Jars	562	Knives, post mortem	173
<b>JEWELER</b> , dissecting forceps tungsten TUC	92	Knives, transplantation	175
Jeweler's forceps	69	Knot-Tiers	223
<b>JOBSON-HORNE</b> , cotton applicators	312	<b>KNOWLES</b> , bandage scissors	133
<b>JOHANSSON</b> , trocars	329	<b>KOCHER</b> , ligature conductors	222
<b>JOHNS-HOPKINS</b> , bulldog clamps	11	<b>KOCHER</b> , ligature needles	216
<b>JOHNS-HOPKINS</b> , dissecting and ligature forceps	32	<b>KOCHER</b> , Non-traumatic stomach and intestinal forceps	525
<b>JOHNS-HOPKINS</b> , setting forceps	11	<b>KOCHER</b> , retractors	260, 266
<b>JONES</b> , towel forceps	51	<b>KOCHER</b> , retractors	251, 260, 266
<b>JOSEPH</b> , delicate hooks	246	<b>KOCHER</b> , stomach and intestinal clamp forceps	522, 525
<b>JOSEPH</b> , dissecting scissors	112	<b>KOCHER-DELICATE</b> , artery forceps	22
<b>JUDD-ALLIS</b> , tissue seizing forceps	518	<b>KOCHER-LANGENBECK</b> , retractors	259
<b>K</b>		<b>KOCHER-OCHSNER</b> , artery forceps	20, 21
<b>KADER</b> , retractors	273	<b>KOERTE</b> , retractors	252, 267
<b>KALT</b> , micro needle holders	212	<b>KÖNIG</b> , ligature conductors	221
<b>KALT</b> , micro needle holders tungsten TUC	205	<b>KÖNIG</b> , nail splitting scissors	135
<b>KALT-ARRUGA</b> , micro needle holders	212	<b>KRAUSE</b> , trocars	330
<b>KALT-CASTROVIEJO</b> , needle holders	212	<b>KROENLEIN</b> , seizing forceps	13
<b>KANTER-HEANEY</b> , hysterectomy forceps	43	<b>KRONECKER</b> , ligature needles	218
<b>KANTROWITZ</b> , dissecting and ligature forceps	35	<b>KUEHNE</b> , cover glass forceps	78
<b>KAPLAN-CRANE</b> , pocket markers	98	<b>KÜNTSCHER</b> , instruments for nails	488, 489
<b>KATZIN</b> , corneal scissors	142	<b>KÜNTSCHER</b> , intramedullary nails	492-494
<b>KATZIN-BARRAQUER</b> , corneal scissors	142	<b>KUTZ-KLEINERT</b> , delicate hooks	242
<b>KAYE</b> , Face-lift scissors TUC	161	<b>L</b>	
<b>KELLY (RICHARDSON)</b> , retractors	264	<b>LA GRANGE</b> , eye scissors	126
<b>KELLY</b> , artery forceps	17	<b>LAHEY</b> , gall duct forceps	37
		<b>LAHEY</b> , retractors	263
		<b>LAMBOTTE</b> , bone holding forceps	460
		<b>LAMBOTTE</b> , osteotomes	426
		<b>LAMBOTTE</b> , raspatories	443



	Page		Page
<b>LAMPERT</b> , chalazion forceps	89	<b>LOCKHART-MUMMERY</b> , probes	311
<b>LANDAU</b> , trocars	329	<b>LOCKLIN</b> , gum scissors	136
<b>LANDAU-SEGOND</b> , hysterectomy forceps	45	<b>LOCKLIN</b> , scissors tungsten TUC	162
<b>LANDGRAF</b> , cotton and dressing pliers	97	<b>LOCKWOOD</b> , tissue seizing forceps	518
<b>LANDOLT</b> , fine scissors	124	<b>LOCKWOOD-ALLIS</b> , tissue seizing forceps	518
<b>LANE</b> , bone holding forceps	457	<b>LONDON COLLEGE</b> , cotton and dressing pliers	95
<b>LANE</b> , screw drivers	491	<b>LONG</b> , hysterectomy forceps	44
<b>LANE</b> , stomach clamp forceps	531	Loop Twisters	223
<b>LANE</b> , tissue forceps	61	<b>LORENZ</b> , bandage scissors	133
<b>LANE</b> , towel forceps	51	<b>LORNA</b> , towel forceps	52
<b>LANGE</b> , clothing scissors	132	<b>LOTH-KLINKENBERGH</b> , scissors	117
<b>LANGE</b> , suture forceps	225	<b>LOTH-SCHOEMAKER</b> , ligature scissors	128
<b>LANGE-HOHMANN</b> , bone levers	397	<b>LOUTE</b> , wire twisting instruments	407
<b>LANGENBECK</b> , amputating knives	172	<b>LOVELACE-DIXON</b> , artery forceps	26
<b>LANGENBECK</b> , bone holding forceps	455	<b>LOWER</b> , gall duct forceps	37
<b>LANGENBECK</b> , elevators	447	<b>LUCAE</b> , mallets	430
<b>LANGENBECK</b> , needle holders	188	<b>LUCAE</b> , nose dressing forceps	77
<b>LANGENBECK</b> , needle holders tungsten TUC	202	<b>LUCAS</b> , bone curettes	441
<b>LANGENBECK</b> , raspatories	443	<b>LUCAS</b> , chisels	417
<b>LANGENBECK</b> , resection saws	384	<b>LUER</b> , bone rongeurs	469
<b>LANGENBECK</b> , retractors	254, 258	<b>LUER</b> , haemorrhoidal forceps atraumatic	48
<b>LANGENBECK-DELICATE</b> , needle holders tungsten TUC	202	<b>LUER</b> , suction tubes	336
<b>LANGENBECK-KOCHER</b> , retractors	259	<b>LUETHY-BECK</b> , needle holders tungsten TUC	202
<b>LANGENBECK-MINI</b> , delicate retractors	247		
<b>LANGENBECK-PARKER</b> , retractors	278	<b>M</b>	
<b>LANGENBECK-RYDER</b> , needle holders tungsten TUC	202	<b>MAGILL</b> , catheter forceps	360
Laryngoscopes	353-360	<b>MAIER-SIMS</b> , polypus forceps	239
Laryngoscopes, fibre optic	357-360	Mallets	427-433
<b>LAWRENCE</b> , dissecting and ligature forceps	34	<b>MARKHAM-MEYERDING</b> , selfretaining retractors	294
Lead Hands	482	<b>MARKWALDER</b> , bone cutting forceps	477
<b>LEKSELL-STILLE</b> , bone rongeurs	473	<b>MARQUARDT</b> , bone rongeurs	470
<b>LEMPERT</b> , bone rongeurs	470	<b>MARTEL</b> , scalp flap forceps	12
Lens holding forceps	90	<b>MARTEL-WILLET</b> , scalp flap forceps	12
<b>LERICHE</b> , artery forceps	16	<b>MARTIN</b> , cartilage forceps	453
<b>LESTER</b> , fixation forceps	84	<b>MARTIN</b> , retractors	262
<b>LEWIN</b> , bone holding forceps	454	<b>MARTIN-CARTILAGE</b> , scissors	118
<b>LEXER</b> , chisels	422, 423	<b>MARTINI</b> , bone curettes	440
<b>LEXER</b> , osteotomes	422, 423	<b>MASS.-GENERAL-HOSPITAL (M.G.H.)</b> , needle holders	183
<b>LEXER</b> , scissors	111	<b>MASSE-ROBIN</b> , abdominal retractors	306
<b>LEXER</b> , scissors tungsten TUC	158	<b>MASSON</b> , needle holders	184
<b>LEXER-BABY</b> , scissors	111	<b>MASSON</b> , needle holders tungsten TUC	197
<b>LICHTENBERG</b> , needle holders	187	<b>MATHIEU</b> , needle holders	186
<b>LICHTENBERG</b> , needle holders tungsten TUC	201	<b>MATHIEU</b> , needle holders tungsten TUC	199
<b>LICHTWITZ</b> , trocars	330	<b>MATHIEU</b> , rectal specula	536
Ligature and dissecting forceps	23-25, 29, 31-36	<b>MATHIEU</b> , retractors	278
Ligature Catcher	223	<b>MATHIEU-DELICATE</b> , needle holders	186
Ligature conductors	220-222	<b>MATHIEU-DELICATE</b> , needle holders tungsten TUC	199
Ligature scissors	128, 129	<b>MATHIEU-RYDER VASCULAR</b> , needle holders tungsten TUC	200
Ligature, instruments	223	<b>MATHIEU-RYDER</b> , needle holders tungsten TUC	200
Ligature, needles	215-219	<b>MATSON</b> , raspatories	446
<b>LINCOLN</b> , scissors	117	<b>MAYFIELD</b> , bone rongeurs	470
<b>LINDEMANN</b> , resection saws	384	<b>MAYO ROBSON</b> , Non-traumatic stomach and intestinal forceps	526
Liposuction and infiltration cannulae	339, 341, 342	<b>MAYO</b> , safety pins	564
<b>LISTER</b> , bandage scissors	133, 134	<b>MAYO</b> , scissors	105
<b>LISTER</b> , dressing forceps	228	<b>MAYO</b> , scissors tungsten TUC	153
<b>LISTER</b> , scissors tungsten TUC	162	<b>MAYO-ADAMS</b> , selfretaining retractors	296
<b>LISTER-EXCENTRIC</b> , bandage scissors	133	<b>MAYO-HARRINGTON</b> , scissors	105
<b>LISTON</b> , amputating knives	172	<b>MAYO-HEGAR</b> , needle holders	184
<b>LISTON</b> , bone cutting forceps	477, 480	<b>MAYO-HEGAR</b> , needle holders tungsten TUC	192
<b>LISTON-KEY</b> , bone cutting forceps	479	<b>MAYO-HEGAR-DELICATE (DE BAKEY)</b> , needle holders TUC	192
<b>LITTAUER</b> , cilia forceps	76	<b>MAYO-HEGAR-DELICATE</b> , needle holders	184
<b>LITTAUER</b> , ligature scissors	128	<b>MAYO-NOBLE</b> , scissors	105
<b>LITTAUER</b> , nail nippers	569	<b>MAYO-ROBSON</b> , stomach and intestinal clamp forceps	521, 526
<b>LITTAUER-LISTON</b> , bone cutting forceps	477	<b>MAYO-RUSS.</b> , grasping forceps	66
<b>LITTLE</b> , retractors	263	<b>MAYO-STILLE</b> , scissors	105
<b>LITTLER</b> , fine scissors	123	<b>MAYO-STILLE</b> , scissors tungsten TUC	154
<b>LITTLEWOOD</b> , tissue seizing forceps	518	<b>MC GIVNEY</b> , haemorrhoidal ligators	553
<b>LLOYD-DAVIS</b> , anastomosis forceps	529	<b>MC INDOE</b> , bone cutting forceps	478
Lobectomy scissors	118		

	Page		Page
<b>MC INDOE</b> , dressing forceps	60	<b>MOD. TÜBINGEN</b> , suture forceps	86
<b>MC INDOE</b> , scissors	118	<b>MOD. USA</b> , dressing and tissue forceps	59
<b>MC INTOSH FIBRE OPTIC</b> , laryngoscopes	357	<b>MOD. USA</b> , plaster cast spreader	319
<b>MC INTOSH</b> , laryngoscopes	353	<b>MOD. USA</b> , umbilical scissors	121
<b>MCDONALD</b> , capsulorhexis forceps	90	<b>MOD. USA/SMITH</b> , bandage scissors	133
<b>MCDONALD</b> , elevators	448	<b>MOD. WIEN</b> , ligature instruments	223
<b>McPHERSON</b> , suture forceps	85	<b>MODELL TÜBINGEN</b> , retractors	262
<b>McPHERSON-KELMAN</b> , suture forceps	85	<b>MOELTGEN</b> , goniometers	373
<b>MEAD</b> , bone rongeurs	469	<b>MOLDESTAD</b> , delicate hooks	244
<b>MEAD</b> , mallets	430	<b>MOLLISON</b> , selfretaining retractors	289
Measuring instruments	371-375	<b>MOLT</b> , raspatories	444
<b>MEEKER</b> , dissecting and ligature forceps	25	<b>MOORE</b> , hand drills	387
<b>MENGHINI</b> , biopsy needles	344	<b>MOORFIELD</b> , suture forceps	84
Meniscotomy knives	467	<b>MORGAN</b> , anoscopes	541
Meniscus and cartilage forceps	453	<b>MORGAN</b> , fibre optic	541
<b>MERIAM</b> , cotton and dressing pliers	96	<b>MORRIS</b> , retractors	261
<b>METZENBAUM</b> , needle holders tungsten TUC	199	<b>MOSQUITO-HALSTED</b> , artery forceps	15
<b>METZENBAUM</b> , scissors	108	<b>MOSQUITO-MICRO</b> , artery forceps	15
<b>METZENBAUM</b> , scissors tungsten TUC	155, 156	<b>MOYNIHAN</b> , hysterectomy forceps	44
<b>METZENBAUM-BABY</b> , scissors	108	Multiple approach retractor	282
<b>METZENBAUM-DELICATE</b> , scissors	110	<b>MUMMERY-LOCKHART</b> , probes	311
<b>METZENBAUM-DELICATE</b> , scissors tungsten TUC	158-160	Muscular forceps	87
<b>METZENBAUM-NELSON</b> , scissors	109	<b>MYRTLE LEAF</b> , probes	310
<b>MEYERDING</b> , delicate retractors	247		
<b>MEYERDING</b> , retractors	273	<b>N</b>	
<b>MEYERDING</b> , selfretaining retractors	294	<b>NABATOFF</b> , varicose vein probe set	312
<b>MEYERDING-MARKHAM</b> , selfretaining retractors	294	<b>NAGER</b> , ligature needles	219
<b>MICHEL</b> , suture clips	225	Nail -files	579
<b>MICHEL</b> , suture forceps	224	Nail nippers	568-570
Micro forceps	71, 72	Nail scissors	135
Micro needle holders	204-213	Nail splitting scissors	135
Micro needle holders tungsten TUC	204, 205	Nails	492-498
Micro needle holders with pen-type handle	206-209	Nasal scissors	119, 120
Micro scissors	143-149	Needle holders	180-213
<b>MICRO WULLSTEIN</b> , suction tubes	335	Needle holders, boomerang	189
<b>MICRO-ADSON</b> , dressing and tissue forceps	59	Needle holders, micro	204-213
<b>MICRO-FRIEDMAN</b> , bone rongeurs	476	Needle holders, tungsten TUC	192-205
<b>MICRO-MOSQUITO</b> , artery forceps	15	Needle Sterilizing Cases	560
<b>MICRO-RYDER</b> , needle holders tungsten TUC	193	Needles, biopsy	343, 344
<b>MICROVASCULAR</b> , needle holders TUC	193	Needles, Deschamps	215
<b>MIDDLEDORPF</b> , retractors	264	Needles, guide	346
<b>MIKULICZ</b> , peritoneal clamp forceps	49	Needles, ligature	215-219
<b>MIKULICZ</b> , retractors	268	Needles, Reverdin	214
<b>MIKULICZ-BABY</b> , peritoneal clamp forceps	49	<b>NEFF</b> , meniscotomy knives	467
<b>MILLER FIBRE OPTIC</b> , laryngoscopes	359	<b>NEGUS</b> , gall duct forceps	40
<b>MILLER</b> , articulating paper forceps	98	<b>NEIVERT</b> , needle holders	181
<b>MILLER</b> , laryngoscopes	355	<b>NEIVERT</b> , needle holders tungsten TUC	195
<b>MILLER-SENN</b> , delicate retractors	250	<b>NELATON</b> , probes	310
<b>MILLIGAN</b> , selfretaining retractors	288	<b>NELSON</b> , grasping forceps	66
<b>MILLS</b> , scissors	116	<b>NELSON</b> , trocars	328
<b>MINI</b> , scalpel blades	167	<b>NELSON-METZENBAUM</b> , scissors	109
<b>MINI</b> , scalpel handles	167	Nerve dissecting scissors	111
<b>MINI-FRIEDMAN</b> , bone rongeurs	468	<b>Nerve</b> , micro scissors	147
<b>MINI-HOHMANN</b> , bone levers	395	<b>NEUMANN</b> , gum scissors	137
<b>MINI-LAMBOTTE</b> , osteotomes	426	Neuro surgery scissors	115-117
<b>MINI-LANGENBECK</b> , delicate retractors	247	<b>NEW ORLEANS</b> , needle holders	183
<b>MINI-LEXER</b> , chisels	422	<b>NEW ORLEANS</b> , needle holders tungsten TUC	194
<b>MINI-LEXER</b> , osteotomes	422	<b>NIRO</b> , wire forceps	401
<b>MISKIMON</b> , selfretaining retractors	289	<b>NOBLE-MAYO</b> , scissors	105
Mixing bowls	559	Non-traumatic stomach and intestinal clamp forceps	524-527
<b>MIXTER</b> , dissecting and ligature forceps	33, 34	Non-traumatic vascular tissue forceps	91
<b>MIXTER</b> , operating scissors	104	<b>nopa PROFI</b> , post mortem saw	484
<b>MIXTER-BABY</b> , dissecting and ligature forceps	33	<b>NORTHBENT</b> , ligature scissors	129
<b>MIXTER-O'SHAUGNESSY</b> , dissecting and ligature forceps	33	Nose dressing forceps	77, 78
<b>MIXTER-OVERHOLT</b> , dissecting and ligature forceps	29	<b>NOTO</b> , sponge holding forceps	234
<b>MOD. BONN</b> , suture forceps	86	<b>NOYES</b> , iris scissors	138
<b>MOD. BONN</b> , fine scissors	124	<b>NUSSBAUM</b> , stomach and intestinal clamp forceps	523
<b>MOD. BONN</b> , iris scissors	81		
<b>MOD. TÜBINGEN VANNAS</b> , secondary cataract scissors	139		



	Page		Page
<b>O</b>			
<b>O'BRIAN</b> , fine scissors	124	Plaster-of-Paris shears	134
<b>OBWEGESER</b> , ramus retractors	257	<b>PLESTER</b> , selfretaining retractors	295
<b>OBWEGESER</b> , soft tissue retractors	255, 256	<b>PLESTER</b> , suction tubes	335
<b>OCHSNER</b> , trocars	329	Pocket markers	98
<b>OCHSNER-KOCHER</b> , artery forceps	20, 21	Podiatry	568-579
<b>O'CONNOR</b> , delicate hooks	243	Polypus forceps	229-239
<b>O'CONNOR-O'SULLIVAN</b> , abdominal retractors	301	<b>POOLE</b> , suction tubes	332
<b>OEHLER</b> , dissecting forceps tungsten TUC	92	<b>POOLE-BABY</b> , suction tubes	332
<b>OLIVECRONA</b> , scissors	117	Post mortem knives	173
<b>OLLIER</b> , retractors	253	Post mortem saw	483-485
<b>OLSEN-HEGAR</b> , needle holders	185	<b>POTTS-DE MARTELL</b> , scissors	116
<b>OLSEN-HEGAR</b> , needle holders tungsten TUC	198	<b>POTTS-SMITH</b> , dissecting forceps tungsten TUC	92
<b>OLSEN-HEGAR-USA</b> , needle holders tungsten TUC	198	<b>POTTS-SMITH</b> , dressing and tissue forceps	63
<b>OMBREDANNE</b> , mallets	427	<b>POTTS-SMITH</b> , micro needle holders	212
Operating knives	169-171	<b>POTTS-SMITH</b> , micro needle holders tungsten TUC	205
Operating scissors	102-105, 122	<b>POTTS-SMITH</b> , scissors for vascular surgery	113, 115
Optical retractor	281, 282	<b>POTTS-SMITH</b> , scissors tungsten TUC	157
<b>OSCINOPA</b> , electric plaster saw	321	<b>PRATT</b> , fistula probe	311
<b>OSCINOPA</b> , post mortem saw	483	<b>PRATT</b> , haemorrhoidal forceps	47
<b>O'SHAUGNESSY-MIXTER</b> , dissecting and ligature forceps	33	<b>PRATT</b> , rectal specula	536
Osteotomes	417-426	<b>PRECISA</b> , blood pressure manometers	379
<b>O'SULLIVAN-O'CONNOR</b> , abdominal retractors	301	<b>PRESBYTERIAN</b> , tubing clamps	53
<b>OTOSKOP UNI</b> , diagnostic set	381	<b>PRINCE</b> , muscular forceps	87
<b>OVERHOLT</b> , dissecting and ligature forceps	24	<b>PRINCE</b> , tonsil scissors	119
<b>OVERHOLT-BABY</b> , dissecting and ligature forceps	23	Probes	310, 311
<b>OVERHOLT-GEISSENDOERFER</b> , dissecting and ligature forceps	23	Proctoscopes	537-543
<b>OVERHOLT-MIXTER</b> , dissecting and ligature forceps	29	Protecting forceps	390
		<b>PROVIDENCE-HOSPITAL</b> , artery forceps	16
<b>P</b>		Puncture/Special Needles	327-349
<b>PALMER</b> , fracture clips	496	<b>PUTTI</b> , rasps	451
<b>PARAMETRIUM</b> , parametrium forceps	46	<b>PYE-SMITH (HARRISON)</b> , sterilizing forceps	564
<b>PARAMETRIUM</b> , scissors tungsten TUC	154	<b>PYNCHON-ANDREWS</b> , suction tubes	331
<b>PARKER</b> , retractors	278		
<b>PARKER-LANGENBECK</b> , retractors	278	<b>Q</b>	
<b>PARTSCH</b> , chisels	418	<b>QUINBY</b> , gum scissors	137
<b>PARTSCH</b> , mallets	430	<b>QUINKE</b> , biopsy needles	344
<b>PATON</b> , micro needle holders	212		
<b>PAUFIQUE</b> , suture forceps	86	<b>R</b>	
<b>PAYR</b> , intestinal and stomach crushing clamps	530	<b>RABINER</b> , percussion hammers	369
<b>PAYR</b> , ligature conductors	221	<b>RADOLF</b> , nail forceps	482
<b>PAYR-BABY</b> , intestinal and stomach crushing clamps	530	<b>RAGNELL (KILNER)</b> , scissors	112
<b>PAYR-SCHMIEDEN</b> , ligature conductors	221	<b>RAGNELL-DAVIS</b> , delicate retractors	250
<b>PEAN</b> , seizing forceps	13	<b>RALK</b> , hand drills	389
<b>PEAN-DELICATE</b> , artery forceps	22	<b>RALK</b> , splinter forceps	75
<b>PEAN-ROCHESTER</b> , artery forceps	18, 19	<b>RAMPLEY</b> , sponge holding forceps	238
<b>PEERS</b> , towel forceps	52	Ramus retractors	257
<b>PEET</b> , splinter forceps	75	<b>RANKIN-CRILE</b> , artery forceps	17
<b>PELKMANN</b> , dressing forceps	235	<b>RANKIN-KELLY</b> , artery forceps	17
<b>PENNINGTON</b> , seizing forceps	13	Raspatories	442-446
Percussion hammers	369, 370	Rasps	451
<b>PERCY</b> , amputation shield	463	Razor Blades	177
Peritoneal clamp forceps	49, 50	Rectal biopsy forceps	551
<b>PERRY</b> , cotton and dressing pliers	97	Rectal Specula	534-536
<b>PERTHES</b> , hand drills	390	Rectoscopes	544-550
<b>PHANEUF</b> , hysterectomy forceps	45	<b>REHN</b> , transplantation knives	175
<b>PHILIPS</b> , screw drivers	491	<b>REILL</b> , micro needle holders	207
<b>PIERCE</b> , trocars	330	<b>REINER</b> , plaster knives	318
<b>PIFFARD</b> , bone curettes	436	Reposition forceps	487
<b>PINARD</b> , stethoscopes	377	<b>RESANO</b> , stomach and intestinal clamp forceps	527
Plaster cast bending forceps	320	Resection and amputating saws	384
Plaster cast spreaders	319	Retractors	242-308
Plaster saws, electric	321, 322	Retractors with fiberoptic illumination	281
Plaster shears	320	Retractors, abdominal	298-307
Plaster, knives	318	Retractors, delicate	250
Plaster, saws	318	Retractors, hand surgery	285
Plaster, trephines	318	Retractors, self-retaining	283, 284, 287-297
		Retractors, spinal	250

	Page		Page
<b>REVERDIN</b> , abdominal spatulas	308	<b>SCHINK</b> , dermatomes	176
<b>REVERDIN</b> , needles	214	<b>SCHMID</b> , special needles	345
<b>REYNOLDS</b> , scissors	112	<b>SCHMIEDEN</b> , ligature needles	217
<b>REZAK-HEANEY</b> , hysterectomy forceps	44	<b>SCHMIEDEN-PAYR</b> , ligature conductors	221
<b>RIBBON</b> , eye scissors	127	<b>SCHMIEDEN-TAYLOR</b> , scissors	116
<b>RICARD</b> , abdominal retractors	306	<b>SCHNIDT-SAWTELL</b> , tonsil hemostatic forceps	27
<b>RICHARDSON (KELLY)</b> , retractors	264	<b>SCHOEMAKER</b> , goitre enucleation scissors	119
<b>RICHARDSON-EASTMAN</b> , retractors	264	<b>SCHOEMAKER-LOTH</b> , ligature scissors	128
<b>RICHTER</b> , operating scissors	104	<b>SCHUHNECHT</b> , selfretaining retractors	289
<b>RICHTER-HEATH</b> , suture forceps	224	<b>SCHUKNECHT</b> , wire cutting scissors	130
<b>RIGHBY</b> , selfretaining retractors	295	<b>SCHULZE-BERGMANN</b> , rectal specula	535
<b>RIRAP</b> , stethoscopes	378	<b>SCHUMACHER</b> , umbilical scissors	121
<b>RISCOPE S</b> , ophthalmoscope	381	<b>SCHWECKENDICK-GOOD</b> , tonsil scissors	119
<b>RISCOPE S</b> , oto-/ophthalmoscope	380	Scissors	102-162
<b>ROBERTS</b> , artery forceps	30	Scissors, abdominal	106
<b>ROBIN-MASSÉ</b> , abdominal retractors	306	Scissors, bandage	132-134
<b>ROCHESTER-CARMALT</b> , artery forceps	27	Scissors, capsulotomy	140
<b>ROCHESTER-PEAN</b> , artery forceps	18, 19	Scissors, cartilage	118
<b>ROEDER</b> , towel forceps	52	Scissors, cloting	132, 133
<b>ROETTGEN-RUSKIN</b> , bone rongeurs	473	Scissors, corneal	141-143
<b>ROGGE</b> , sterilizing forceps	564	Scissors, coronary	115
<b>ROLLET</b> , delicate hooks	246	Scissors, crown	130, 131
<b>ROSCHKE</b> , anoscopes	537	Scissors, cuticle	135
<b>ROSSEGGER-KLIMA</b> , biopsy needles	343	Scissors, dissecting	108-112
<b>ROTTER</b> , ligature needles	219	Scissors, enterotomy	118
<b>ROUX</b> , retractors	277	Scissors, episiotomy	121
<b>ROWE</b> , reposition forceps	487	Scissors, eye	125-127, 138-143
<b>RUDD</b> , haemorrhoidal ligators	554	Scissors, fine	122-124
<b>RUMEL</b> , dissecting and ligature forceps	31	Scissors, goitre enucleation	119
<b>RUSKIN</b> , bone rongeurs	471, 475	Scissors, gum	136, 137
<b>RUSKIN-LISTON</b> , bone cutting forceps	478	Scissors, gynecological	105-107
<b>RUSKIN-MINI</b> , bone rongeurs	471	Scissors, incision	104
<b>RUSS. MODELL</b> , grasping forceps	68	Scissors, iridectomy	138
<b>RUSS.-MAYO</b> , grasping forceps	66	Scissors, iris	125, 138
<b>RYDER/FRENCH EYE</b> , needle holders tungsten TUC	193	Scissors, ligature	128, 129
<b>RYDER-LANGENBECK</b> , needle holders tungsten TUC	202	Scissors, lobectomy	118
<b>RYDER-MATHIEU VASCULAR</b> , needle holders tungsten TUC	200	Scissors, micro	143-149
<b>RYDER-MATHIEU</b> , needle holders tungsten TUC	200	Scissors, micro adventitia	145, 147
<b>RYDER-MICRO</b> , needle holders tungsten TUC	193	Scissors, micro dissection	145, 147
		Scissors, micro nerve	147
<b>S</b>		Scissors, nail	135
Safety pins	564	Scissors, nail splitting	135
<b>SALAH</b> , biopsy needles	343	Scissors, nasal	119, 120
<b>SALENIUS</b> , meniscotomy knives	467	Scissors, nerve dissecting	111
<b>SAMII</b> , grasping forceps	70	Scissors, neuro surgery	115-117
<b>SANVENERO</b> , scissors	112	Scissors, operating	102-105, 122
<b>SAROT</b> , bronchus forceps	30	Scissors, plaster-of-Paris	134
<b>SAROT</b> , needle holders	183	Scissors, secondary cataract	139
<b>SAROT</b> , needle holders tungsten TUC	197	Scissors, strabismus	126
<b>SATINSKY</b> , scissors	117	Scissors, super-cut SC	101
<b>SATTERLEE</b> , amputating saws	384	Scissors, tenotomy	126, 140
<b>SATTLER</b> , muscular forceps	87	Scissors, tonsil	119
<b>SAUERBRUCH</b> , bone rongeurs	474	Scissors, tungsten TUC	152-162
<b>SAUERBRUCH</b> , retractors	260, 274	Scissors, umbilical	121
Saw blades for electric plaster saw	323	Scissors, vascular surgery	113-117
Saws	384, 482-485	Scissors, wire cutting	130
Saws, plaster	318	Screw drivers	491
<b>SAWTELL-SCHNIDT</b> , tonsil hemostatic forceps	27	<b>SCUDDER</b> , Non-traumatic stomach and intestinal forceps	526
<b>SAWYER</b> , rectal specula	534	<b>SCUDDER</b> , stomach and intestinal clamp forceps	523, 526
Scalp flap forceps	12, 26	<b>SEBILEAU</b> , elevators	447
<b>SCALP-CONTOUR</b> , selfretaining retractors	294	Secondary cataract scissors	139
Scalpel blades	167, 168	<b>SEDILLOT</b> , raspatories	445
Scalpel, handles	165-167	<b>SEGOND</b> , hysterectomy forceps	45
Scalpels	165-177	<b>SEGOND-LANDAU</b> , hysterectomy forceps	45
<b>SCHAEDEL</b> , towel forceps	51	Seizing forceps	12, 13
<b>SCHANZ</b> , wires	503	Self-retaining retractors	283, 284, 287-297
<b>SCHÉDE</b> , bone curettes	435	<b>SELLORS-CRAFOORD</b> , auricle forceps	29
<b>SCHINDLER</b> , peritoneal clamp forceps	50	<b>SEMB</b> , bone cutting forceps	480
		<b>SEMB</b> , bone holding forceps	456



	Page		Page
<b>SEMB</b> , bone rongeurs	472	<b>STELLBRINK</b> , bone rongeurs	468
<b>SEMB</b> , raspatories	446	Sterilizing forceps	564
<b>SEMKEN</b> , dissecting forceps tungsten TUC	92	<b>STERNUM</b> , wire forceps TUC	403
<b>SEMKEN</b> , dressing and tissue forceps	60, 61	<b>STERNUM</b> , wire twisting forceps tungsten TUC	203
<b>SEMM</b> , abdominal retractors	303	Stethoscopes	377, 378
<b>SENN-GREEN</b> , delicate retractors	247	<b>STEVENS</b> , iris forceps	80
<b>SENNING (SWED. MODEL)</b> , needle holders	183	<b>STEVENS</b> , micro needle holders	212
<b>SENNING (SWED. PATTERN)</b> , needle holders tungsten TUC	194	<b>STEVENS</b> , scissors tungsten TUC	161
<b>SENN-MILLER</b> , delicate retractors	250	<b>STEVENS</b> , tenotomy scissors	126
<b>SENN-MILLER-BABY</b> , delicate retractors	250	<b>STIEGLITZ</b> , splinter forceps	75
Sensibility instruments	376	<b>STILLE</b> , bone rongeurs	472
Setting forceps	11	<b>STILLE</b> , chisels	421
<b>SEUTIN</b> , bandage scissors	134	<b>STILLE</b> , dressing and tissue forceps	65
Shears, plaster-of-Paris	134	<b>STILLE</b> , hand drills	386
<b>SHORTBENT</b> , ligature scissors	129	<b>STILLE</b> , kidney pedicle clamp forceps	38
<b>SIEBOLD</b> , scissors	107	<b>STILLE</b> , Mini plaster shear	320
<b>SIMON</b> , fistula knives	174	<b>STILLE</b> , osteotomes	421
<b>SIMON</b> , retractors	262	<b>STILLE-BARRAYA</b> , tissue forceps	65
<b>SIMS</b> , rectal specula	534	<b>STILLE-DOYEN</b> , retractors	266
<b>SIMS</b> , scissors	107	<b>STILLE-LISTON</b> , bone cutting forceps	479
<b>SIMS</b> , scissors tungsten TUC	155	<b>STILLE-LUER</b> , bone rongeurs	473
<b>SIMS-MAIER</b> , polypus forceps	239	<b>STILLE-MAYO</b> , scissors	105
<b>SINGLEY-TUTTLE</b> , grasping forceps	66	<b>STILLE-MAYO</b> , scissors tungsten TUC	154
<b>SINUSCOPY</b> , trocars	327	<b>STILLE-RUSKIN</b> , bone rongeurs	472
<b>SMILLIE</b> , knee retractors	466	<b>STILLE-SHERMAN</b> , hand drills	385
<b>SMILLIE</b> , meniscotomy knives	467	Stomach and intestinal clamp forceps	520-523
<b>SMITH (MOD. USA)</b> , bandage scissors	133	Stomach and intestinal crushing clamps	530
<b>SMITH</b> , wire cutting scissors	130	Stomach clamp forceps	531
<b>SMITH-BUIE</b> , rectal specula	536	Stopcocks	349
<b>SMITH-FERRIS</b> , tissue forceps	65	Strabismus scissors	126
<b>SMITH-HEYWOOD</b> , sponge holding forceps	236	<b>STRATTE</b> , needle holders	185
<b>SMITH-PETERSEN</b> , chisels	419	<b>STRATTE</b> , needle holders tungsten TUC	197
<b>SMITH-PETERSEN</b> , osteotomes	419	<b>STRAUSS</b> , rectoscope	548
<b>SMITH-PETERSON</b> , bone rongeurs	475	Strippers, vascular	315
<b>SMITH-POTTS</b> , dissecting forceps tungsten TUC	92	<b>STRULLY</b> , scissors	115
<b>SMITH-POTTS</b> , dressing and tissue forceps	63	Suction tubes	331-337, 503
<b>SMITH-POTTS</b> , micro needle holders	212	<b>SULLIVAN (BROPHY)</b> , fine scissors	123
<b>SMITH-POTTS</b> , micro needle holders tungsten TUC	205	<b>SULLIVAN</b> , gum scissors	137
<b>SMITH-POTTS</b> , scissors	113, 115, 118	Super Cut Scissors	101
<b>SMITH-POTTS</b> , scissors tungsten TUC	157	Suture	180-225
<b>SNELLEN</b> , entropium forceps	88	Suture forceps	224, 225
<b>SNITMAN</b> , self-retaining retractors	284	Suture tweezers	97
Soft tissue retractors	255, 256	Suture tying forceps with platform	71, 72
Solutions bowls	562	Suture, clips	225
Spatulas abdominal	308	Suture, forceps	85, 86
Special needles	345	<b>SWED. MODEL (SENNING)</b> , needle holders	183
Special needles/puncture	327-349	<b>SYME</b> , ligature needles	216
<b>SPENCER</b> , ligature scissors	128	Syringes	348
<b>SPENCER-DELICATE</b> , ligature scissors	128		
<b>SPENCER-WELLS</b> , artery forceps	14	<b>T</b>	
Sphincteroscopes	537-541	Tampers	451
Spinal retractors	250	Tampon forceps	78
Splinter forceps	73-75	<b>TAYLOR</b> , bone levers	398
Sponge holding forceps	228-239	<b>TAYLOR</b> , dressing and tissue forceps	61
<b>SPRATT</b> , bone curettes	435	<b>TAYLOR</b> , percussion hammers	369
Spray gun	590, 591	<b>TAYLOR</b> , spinal retractors	250
<b>ST. MARKS</b> , retractors	275	<b>TAYLOR-CUSHING</b> , dissecting forceps tungsten TUC	93
<b>ST. MARTIN</b> , suture forceps	85	<b>TAYLOR-SCHMIEDEN</b> , scissors	116
<b>STACKE</b> , probes	310	Tendon seizing instruments	464
<b>STADLER-BRAUN</b> , episiotomy scissors	121	Tendon stripper	465
<b>STANDARD</b> , dressing forceps	57	Tenotomy scissors	126, 140
<b>STANDARD</b> , gum scissors	137	<b>TERRIER</b> , artery forceps	14
<b>STANDARD</b> , operating scissors	102	<b>TERSON</b> , iris forceps	83
<b>STANDARD</b> , scissors tungsten TUC	152, 153	<b>THIERSCH</b> , transplantation knives	175
<b>STANDARD</b> , tissue forceps	57	<b>THIESS</b> , mallets	430
<b>STANDARD</b> , trocars	327	<b>THOMS-ALLIS</b> , tissue seizing forceps	518
<b>STEINBACH</b> , mallets	432	<b>THOREK</b> , scissors	111
<b>STEINMANN</b> , pins	399, 497, 498	<b>THORPE</b> , calliper	372
<b>STEINMANN</b> , tendon seizing instruments	464		

	Page		Page
Tissue forceps	57-65, 67, 68	Vessel dilators	72
Tissue seizing forceps	9	<b>VIRCHOW</b> , brain knives	173
Tissue seizing forceps	517-519	<b>WISE</b> , suture tying forceps with platform	71
<b>TOENNIS</b> , dissecting and ligature forceps	36	<b>VOLKMANN</b> , bone curettes	434, 440
<b>TOENNIS</b> , needle holders	188	<b>VOLKMANN</b> , retractors	251, 252
<b>TOENNIS</b> , needle holders tungsten TUC	201		
<b>TOENNIS</b> , scissors	116	<b>W</b>	
<b>TOENNIS-ADSON</b> , scissors	116	<b>WACHENFELDT</b> , suture forceps	224
<b>TOENNIS-ADSON-DELICATE</b> , scissors tungsten TUC	161	<b>WAGNER</b> , fine scissors	122
<b>TOHOKU-JAPAN</b> , towel forceps	52	<b>WALB</b> , post mortem knives	173
Tonsil hemostatic forceps	27	<b>WALDMANN</b> , episiotomy scissors	121
Tonsil scissors	119	<b>WALTER</b> , retractor	250
Towel forceps	51, 52	<b>WALTER-CARMALT</b> , splinter forceps	73
<b>TOWNLEY</b> , caliper	372	<b>WALTON</b> , fine scissors	124
Transplantation knives	175	<b>WALTON</b> , finger ring saws	482
<b>TRAVERS</b> , selfretaining retractors	288	<b>WALTON</b> , polypus forceps	239
Tray	561	<b>WALTON</b> , selfretaining retractors	297
<b>TRELAT</b> , ligature needles	218	<b>WALTON-LISTON</b> , bone cutting forceps	478
Trephines, plaster	318	<b>WALTON-YANKAUER</b> , suction tubes	331
<b>TROCAR</b> , biopsy needles	344	<b>WANGENSTEEN</b> , dissecting forceps tungsten TUC	94
Trocars	327-330	<b>WANGENSTEEN</b> , dressing forceps	65
<b>TROELTSCH (WILDE)</b> , ear dressing forceps	77	<b>WANGENSTEEN</b> , needle holders	185
<b>TROEMNER</b> , percussion hammers	370	<b>WANGENSTEEN</b> , needle holders tungsten TUC	197
<b>TROUTMAN (CORNEAL)</b> , iris forceps	82	<b>WANGENSTEEN-DELICATE</b> , delicate needle holders	185
<b>TROUTMAN</b> , corneal section scissors	141	<b>WARTENBERG</b> , sensibility instruments	376
<b>TROUTMAN</b> , micro needle holders	207	<b>WATSON</b> , dermatomes	176
<b>TROUTMAN-BARRAQUER</b> , micro needle holders	206	<b>WAUGH</b> , grasping forceps	67
<b>TROUTMAN-CHRIS</b> , blade breakers	177	<b>WEBSTER</b> , needle holders	181
Tubing clamps	53	<b>WEBSTER</b> , needle holders tungsten TUC	195
<b>TÜBINGEN MODELL</b> , retractors	262	<b>WECKER</b> , iris scissors	138
<b>TÜBINGER MODELL</b> , selfretaining retractors	296	<b>WEITLANER</b> , selfretaining retractors	287
<b>TUDOR-EDWARDS</b> , bone cutting forceps	479	<b>WEITLANER-BABY</b> , selfretaining retractors	287
<b>TUFFIER</b> , abdominal spatulas	308	<b>WELLS-SPENCER</b> , artery forceps	14
<b>TUFFIER</b> , blood vessel clamps	12	<b>WERTHEIM</b> , hysterectomy forceps	41, 42
<b>TUFFIER</b> , retractors	267	<b>WERTHEIM</b> , needle holders	185
Tungsten Carbide Tips with pyramidal profile	190, 191	<b>WERTHEIM</b> , needle holders tungsten TUC	198
<b>TUOHY</b> , biopsy needles	344	<b>WERTHEIM</b> , scissors	106
<b>TURNBULL</b> , nail forceps	568	<b>WERTHEIM-CULLEN</b> , hysterectomy forceps	44
<b>TUTTLE-SINGLEY</b> , grasping forceps	66	<b>WESTCOTT</b> , micro scissors	143
		<b>WESTCOTT</b> , tenotomy scissors	140
<b>U</b>		<b>WESTERMARK</b> , dressing forceps	232
<b>UCKERMANN</b> , cotton applicators	312	<b>WIGMORE</b> , plaster saws	318
<b>ULRICH</b> , bone holding forceps	462	<b>WIKSTROEM</b> , dissecting and ligature forceps	41
<b>ULRICH</b> , polypus forceps	229	<b>WILDBERG</b> , clips	496
Umbilical scissors	121	<b>WILDE (TROELTSCH)</b> , ear dressing forceps	77
Universal tray	561	<b>WILLET-MARTEL</b> , scalp flap forceps	12
<b>UNIVERSAL</b> , bandage scissors	132	<b>WILLIAMS</b> , tissue seizing forceps	518
<b>UNIVERSAL</b> , bone rongeurs	468	<b>WILLIGER</b> , bone curettes	440
<b>UNIVERSAL</b> , hand drills	389	<b>WILLIGER</b> , elevators	447
<b>UNIVERSAL</b> , scissors tungsten TUC	162	<b>WILLIGER</b> , mallets	428
<b>UNIVERSAL</b> , trocars	327	<b>WILLIGER</b> , raspatories	444
<b>UNIVERSAL</b> , wire cutting scissors	130	<b>WILMER</b> , eye scissors	126
<b>V</b>		Wire cutting scissors	130
<b>VACUNOPA</b> , vacuum cleaner	324	Wire forceps	401-403, 405, 406
<b>VAN BUREN</b> , bone holding forceps	452	Wire twisting instruments	407
<b>VANNAS MOD. TÜBINGEN</b> , secondary cataract scissors	139	Wires	499-502
<b>VANNAS</b> , secondary cataract scissors	139	<b>WISCONSIN (FOREGGER) FIBRE OPTIC</b> , laryngoscopes	358
Varicose vein probe set	312	<b>WISCONSIN (FOREGGER)</b> , laryngoscopes	354
Vascular surgery scissors	113	<b>WOLFF</b> , Plaster cast bending forceps	320
Vascular surgery scissors	113-117	<b>WULLSTEIN MICRO</b> , suction tubes	335
Vascular, dilators	314, 314	<b>WULLSTEIN</b> , selfretaining retractors	289
Vascular, strippers	315	<b>Y</b>	
<b>VERBRUGGE</b> , bone holding forceps	459	<b>YANCOSKIE</b> , retractors	280
<b>VERNET-GIL</b> , delicate retractors	249	<b>YANKAUER</b> , suction tubes	331
<b>VERNIER</b> , caliper	372, 373	<b>YANKAUER-WALTON</b> , suction tubes	331
<b>VERRES</b> , special needles	345	<b>YEOMAN</b> , rectal biopsy forceps	551
		<b>YOUNG-HRYNTSCHAK</b> , boomerang needle holders	189



**Z**

<b>ZAUFAL-JANSEN</b> , bone rongeurs	471
<b>ZENKER</b> , dissecting and ligature forceps	32
<b>ZENKER</b> , retractors	272
<b>ZIEGLER</b> , cilia forceps	76
<b>ZWEIFEL</b> , needle holders	187
<b>ZWEIFEL</b> , needle holders tungsten TUC	202



# Índice alfabético

	Página		Página
<b>A</b>		<b>B</b>	
Accesorios para clavos intramedulares con ganchos	490	<b>BABCOCK</b> , pinzas para coger intestinos	9
Accesorios para power drills	392	<b>BABCOCK</b> , pinzas para coger intestinos	519
Accu power drill	391	<b>BABINSKY</b> , martillos de percusión	369
Acumulador / cargador para power drills	393	<b>BABY-KOCHER</b> , pinzas-clamps estomacales y intestinales Atrauma	526
<b>ADAMS-MAYO</b> , separadores autoestáticos	296	<b>BABY/LIGHTWEIGHT-DUPLEX</b> , estetoscopios	378
<b>ADISON</b> , pinza de protección	390	<b>BABY-ADSON</b> , pinzas hemostáticas	25
<b>ADLERKREUTZ</b> , pinzas de disección con dientes	65	<b>BABY-BALFOUR</b> , separadores abdominales	299
<b>ADSON</b> , elevadores	449	<b>BABY-CRILE-WOOD</b> , porta-agujas	182
<b>ADSON</b> , pinzas de disección	59, 60	<b>BABY-CRILE-WOOD</b> , porta-agujas tungsteno TUC	196
<b>ADSON</b> , pinzas de disección con dientes	59, 60	<b>BABY-DOYEN</b> , pinzas-clamps estomacales y intestinales	520
<b>ADSON</b> , pinzas de disección tungsteno TUC	93	<b>BABY-KOCHER</b> , pinzas-clamps estomacales y intestinales	521, 526
<b>ADSON</b> , pinzas hemostáticas	25	<b>BABY-LEXER</b> , tijeras para preparaciones	111
<b>ADSON</b> , porta-agujas	183	<b>BABY-METZENBAUM</b> , tijeras para preparaciones	108
<b>ADSON</b> , separadores autoestáticos	290, 291	<b>BABY-MIKULICZ</b> , pinzas-clamps para peritoneo	49
<b>ADSON</b> , tubos de aspiración	335	<b>BABY-MIXTER</b> , pinzas para preparaciones y ligaduras	33
<b>ADSON-ANDERSON</b> , separadores autoestáticos	290	<b>BABY-OVERHOLT</b> , pinzas para preparaciones y ligaduras	23
<b>ADSON-BABY</b> , pinzas hemostáticas	25	<b>BABY-POOLE</b> , tubos de aspiración	332
<b>ADSON-BABY</b> , separadores autoestáticos	292	<b>BABY-SENN-MILLER</b> , separadores finas	250
<b>ADSON-BECKMANN</b> , separadores autoestáticos	293	<b>BABY-WEITLANER</b> , separadores autoestáticos	287
<b>ADSON-BROWN</b> , pinzas de disección con dientes	60	<b>BACKHAUS</b> , pinzas de campo	52
<b>ADSON-MICRO</b> , pinzas de disección	59	<b>BACKHAUS</b> , pinzas para compresas	52
<b>ADSON-MICRO</b> , pinzas de disección con dientes	59	<b>BACON</b> , pinzas-gubias	470
<b>ADSON-TOENNIS</b> , tijeras para cirugía vasculares	116	<b>BAINBRIDGE</b> , pinzas hemostáticas	27
<b>ADSON-TOENNIS-DELICATE</b> , tijeras tungsteno TUC	161	<b>BAINBRIDGE</b> , pinzas-clamps estomacales y intestinales Atrauma	524
<b>ADVENTITIA</b> , micro-tijeras	145, 147	<b>BALFOUR US-TYPE</b> , separadores abdominales	299
Agrafes	225	<b>BALFOUR</b> , separadores abdominales	299, 300
Agujas	499-502	<b>BALFOUR-BABY</b> , separadores abdominales	299
Agujas de guía	346	<b>BALL &amp; SOCKET</b> , pinzas de campo	52
Agujas de <b>REVERDIN</b>	214	<b>BALL &amp; SOCKET</b> , pinzas para compresas	52
Agujas especiales	345	<b>BALLANTINE-HEANEY</b> , pinzas-clamps para histerectomía	43
Agujas especiales/punción	327-349	<b>BALLENGER-FOERSTER</b> , pinzas para esponjas	237
Agujas para biopsia	343, 344	Bandeja	561
Agujas para ligaduras	215-219	<b>BARRAQUER</b> , micro-porta-agujas	206
Air power drill	391	<b>BARRAQUER</b> , pinzas depilatorias	76
<b>ALAN PARKS</b> , anoscopios	537	<b>BARRAQUER</b> , pinzas para la cámara anterior	85
<b>ALDERDYCE</b> , elevadores	448	<b>BARRAQUER</b> , pinzas-tijeras para inductomia	138
<b>ALEXANDER</b> , cinceles	418	<b>BARRAQUER-KATZIN (COLIBRI)</b> , pinzas para iris	82
<b>ALEXANDER</b> , raspadores	446	<b>BARRAQUER-KATZIN</b> , pinzas-tijeras para córnea	142
Alicates planos	404	<b>BARRAQUER-TROUTMAN</b> , micro-porta-agujas	206
<b>ALLIS</b> , pinzas para coger tejidos	9	<b>BARRAYA-STILLE</b> , pinzas de disección con dientes	65
<b>ALLIS</b> , pinzas para coger tejidos y intestinos	517	<b>BAUMGARTNER</b> , porta-agujas	184
<b>ALLIS-ADAIR</b> , pinzas para coger tejidos y intestinos	517	<b>BECK-LUETHY</b> , porta-agujas tungsteno TUC	202
<b>ALLIS-BABY</b> , pinzas para coger tejidos y intestinos	517	<b>BECKMANN</b> , separadores autoestáticos	292
<b>ALM</b> , separadores autoestáticos	283	<b>BECKMANN-ADSON</b> , separadores autoestáticos	293
<b>ALY</b> , instrumentos sensibilidad	376	<b>BECKMANN-EATON</b> , separadores autoestáticos	293
<b>ANDERSON-ADSON</b> , separadores autoestáticos	290	<b>BEEBEE</b> , tijeras para coronas	130, 131
<b>ANDREWS-PYNCHON</b> , tubos de aspiración	331	<b>BEER</b> , pinzas depilatorias	76
Anestesia	353-363	<b>BEESON</b> , separadores de enyesados	319
Anoscopios	537-543	<b>BENGOLEA</b> , pinzas hemostáticas	28
<b>ANVIL</b> , pinzas corta-unas	571	<b>BENSAUDE</b> , anoscopios	540
<b>ARLT-FISCHER</b> , pinzas para iris	80	<b>BERENS</b> , pinzas musculares	88
<b>ARRUGA</b> , micro-porta-agujas	212	<b>BERGMANN</b> , martillos	427
<b>ARRUGA</b> , pinzas capsulares	83	<b>BERGMANN</b> , sierras para vendajes enyesados	318
<b>ARRUGA</b> , porta-agujas	180	<b>BERGMANN</b> , tijeras para vendajes	132
<b>ARRUGA</b> , porta-agujas tungsteno TUC	201	<b>BERKE</b> , pinzas de chalazión	89
<b>ARRUGA-KALT</b> , micro-porta-agujas	212	<b>BERLINER</b> , martillos de percusión	370
Artroscopio	408-415	<b>BERNHARD</b> , pinzas de campo	51
<b>AUSTIN</b> , pinzas de ligadura	71	<b>BERNHARD</b> , pinzas para compresas	51
<b>AUSTRALIA</b> , separadores para dedos	283	<b>BEYER</b> , pinzas-gubias	471
<b>AUSTRALIA</b> , separadores para la cirugía de la mano	285	<b>BILLROTH</b> , separadores	252
<b>AYER</b> , pinzas de chalazión	88	<b>BIRCHER</b> , bisturios para meniscos	467
		<b>BIRCHER-GANSKE</b> , pinzas para huesos	453
		<b>BIRKETT</b> , pinzas para preparaciones y ligaduras	41

<b>BISHOP-HARMAN</b> , pinzas para iris	82	<b>CAPLAN</b> , tijeras nasales	119
Bisturíes	165-177	<b>CARDINALE</b> , tijeras para ginecología	107
Bisturíes para abscesos	174	<b>CARDINALE</b> , tijeras tungsteno TUC	155
Bisturíes para fistulas	174	<b>CARDIOPHON</b> , estetoscopios	378
Bisturíes para meniscos	467	<b>CARMALT-ROCHESTER</b> , pinzas hemostáticas	27
Bisturíes para operaciones	169-171	<b>CARMALT-WALTER</b> , pinzas para espinas	73
<b>BLASCOVICS</b> , pinzas musculares	87	<b>CAROLL</b> , goniómetros	373
<b>BLOND</b> , anoscopios	542, 543	<b>CAROLL</b> , instrumentos para coger tendones	464
<b>BLOUNT</b> , elevadores para huesos	398	<b>CARREL</b> , pinzas hemostáticas	14
<b>BLOUNT</b> , separadores para rodilla	466	<b>CARROLL</b> , porta-agujas	182
<b>BLUEPOWER</b> , cortador eléctrico para vendajes duros	322	<b>CARROLL</b> , porta-agujas tungsteno TUC	194
<b>BLUMENTHAL</b> , pinzas-gubias	469	<b>CARTILAGE-MARTIN</b> , tijeras	118
Bocas de carburo de tungsteno con perfil	190, 191	<b>CASTROVIEJO</b> , círculo	375
<b>BÖHLER</b> , estribos para extensión	399	<b>CASTROVIEJO</b> , micro-porta-agujas	210, 213
<b>BÖHLER</b> , pinzas-gubias	471	<b>CASTROVIEJO</b> , micro-porta-agujas tungsteno TUC	204, 205
<b>BOLEY</b> , calibrador	373	<b>CASTROVIEJO</b> , pinzas capsulares	83
Bombillos de laringoscopio	356	<b>CASTROVIEJO</b> , pinzas de fijación	84
Bombillos de laringoscopio Fibre Optic	360	<b>CASTROVIEJO</b> , pinzas para romper hojas	177
<b>BONACCOLTO</b> , pinzas para sutura	85	<b>CASTROVIEJO</b> , pinzas para sutura	85
<b>BONNEY</b> , pinzas de disección tungsteno TUC	94	<b>CASTROVIEJO</b> , pinzas-tijeras para córnea	141
<b>BONNEY</b> , pinzas para coger	68	<b>CASTROVIEJO</b> , pinzas-tijeras para iridectomía	138
Boomerang porta-agujas	189	<b>CASTROVIEJO-EPKER</b> , círculo	375
<b>BÖTTCHER</b> , tijeras para amígdalas	119	<b>CASTROVIEJO-KALT</b> , micro-porta-agujas	212
<b>BOYNTON</b> , porta-agujas	180	<b>CATLIN</b> , cuchillas para amputación	172
<b>BOYNTON</b> , porta-agujas tungsteno TUC	201	Cepillos de limpieza	583-589
<b>BOYS-ALLIS</b> , pinzas para coger tejidos y intestinos	518	<b>CHADWICK</b> , tijeras oculares	126
<b>BOZEMANN</b> , instrumentas ligaduras	223	<b>CHAPUT</b> , pinzas para coger	12
<b>BOZEMANN</b> , pinzas para tapones	233	<b>CHARRIERE</b> , sierras para amputación	384
<b>BOZEMANN</b> , porta-agujas	182	<b>CHEATLE</b> , pinzas para esterilización	564
<b>BOZEMANN</b> , porta-agujas tungsteno TUC	197	<b>CHERON</b> , pinzas para tapones	234
<b>BOZEMANN-DOUGLAS</b> , pinzas para tapones	233	<b>CHILDE</b> , pinzas para agrafes	225
<b>BRAND</b> , instrumentos para coger tendones	464	<b>CHRIS-TROUTMAN</b> , pinzas para romper hojas	177
<b>BRAUN-STADLER</b> , tijeras para episiotomía	121	<b>CHURCH</b> , tijeras para cirugía vasculares	117
<b>BRIDGE</b> , pinzas para preparaciones y ligaduras	34	Cinceles	417-426
<b>BRINKHORST</b> , pinzas capsulares	83	Cizallas para cortar alambre	130
Broca para tornillos para huesos	513	Cizallas para escayola	320
<b>BRODIE</b> , sondas	311	Cizallas para vendajes enyesados	134
<b>BROPHY (SULLIVAN)</b> , tijeras finas	123	Clamp sujetador de huesos	394
<b>BROPHY</b> , pinzas de disección	63	Clamps bulldog	10, 11
<b>BROPHY</b> , pinzas de disección con dientes	63	Clamps para vasos	12
<b>BROWN</b> , pinzas de disección con dientes	64	<b>CLAR 55</b> , lámparas frontales	368
<b>BROWN</b> , porta-agujas	183	<b>CLAR STANDARD</b> , lámparas frontales	368
<b>BROWN-ADSON</b> , pinzas de disección con dientes	60	<b>CLASSON</b> , tijeras para cirugía vasculares	117
<b>BROWNE-DENIS</b> , separadores abdominales	301	<b>CLAUS</b> , agujas para ligaduras	218
<b>BRUNNER</b> , agujas para ligaduras	216, 217	<b>CLAUS-EICKEN</b> , agujas para ligaduras	219
<b>BRUNNER</b> , pinzas-clamps estomacales y intestinales	520	Clavos	492-498
<b>BRUNNER</b> , separadores	263	Clavos intramedulares	495
<b>BRUNNER</b> , sondas conductoras	220	<b>CLEVELAND</b> , pinzas cortantes para huesos	478
<b>BRUNNER-FERROZELL</b> , sondas conductoras	222	<b>CLEVELAND</b> , pinzas-gubias	468
<b>BRUNS</b> , cizallas para vendajes enyesados	134	<b>CLEVELAND-GARDNER</b> , pinzas cortantes para huesos	477
<b>BRUNS</b> , cucharillas cortantes	434, 437	<b>CLOWARD HIBBS SPRATT</b> , cucharillas cortantes	437
<b>BRYANT</b> , pinzas para esponjas	228	<b>COAKLEY</b> , trocares	330
<b>BUCK</b> , martillos de percusión	369	<b>COBB</b> , cinceles	424
<b>BUCK</b> , tijeras para ligaduras	129	<b>COBB</b> , cucharillas cortantes	439
<b>BULEAU</b> , trocares	328	<b>COBB</b> , elevadores	449
<b>BUNNELL</b> , perforadores de mano	388	<b>COGSWELL</b> , tubos de aspiración	336
<b>BUNNELL</b> , separadores para tendones	465	<b>COLBRI (BARRAQUER-KATZIN)</b> , pinzas para iris	82
<b>BUSCH</b> , tijeras umbilicales	121	<b>COLLEGE-LONDON</b> , pinzas para algodón y curaciones	95
<b>BYRD</b> , tubos de aspiración	332	<b>COLLER</b> , pinzas hemostáticas	17
<b>C</b>		<b>COLLIER</b> , porta-agujas	180
Cadres de esterilización	564	<b>COLLIN</b> , bisturíes para operaciones	170
<b>CAIRNS</b> , pinzas hemostáticas	22	<b>COLLIN</b> , cuchillos para amputación	172
Cajas para instrumentos	562	<b>COLLIN</b> , dinamómetro	374
Calibrador	372, 373	<b>COLLIN</b> , mangos de bisturíes	166
<b>CAMPBELL</b> , trocares	328	<b>COLLIN</b> , martillos	429
<b>CANNY RYALL</b> , separadores	279	<b>COLLIN</b> , pinzas para agrafes	224
Cánulas de liposucción y infiltración	339, 341, 342	<b>COLLIN</b> , pinzas para coger	13
		<b>COLLIN</b> , pinzas para tapones	234
		<b>COLLIN</b> , separadores abdominales	304, 305



	Página		Página
<b>COLLIN-BABY</b> , separadores abdominales	304	<b>DE BAKEY</b> , pinzas atrauma	91
<b>COLLIN-DUVAL</b> , pinzas para coger	66	<b>DE BAKEY</b> , pinzas de disección tungsteno TUC	94
<b>COLLIN-HARTMANN</b> , separadores	277	<b>DE BAKEY</b> , porta-agujas tungsteno TUC	192
<b>CONE</b> , separadores autoestáticos	292	<b>DE BAKEY</b> , tijeras para cirugía vasculares	113, 116
Conector	363	<b>DE BAKEY</b> , tijeras tungsteno TUC	157
<b>CONVERSE</b> , porta-agujas tungsteno TUC	195	<b>DE BAKEY</b> , tubos de aspiración	331
<b>CONVERSE-DERF</b> , porta-agujas	180	<b>DE LA ROZA</b> , agujas para ligaduras	217
<b>COOLEY</b> , dilatadores vasculares	313	<b>DE MARTEL-POTTS</b> , tijeras para cirugía vasculares	116
<b>COOLEY</b> , tubos de aspiración	333	<b>DE MARTEL-WOLFSON</b> , pinzas-clamps intestinales	532, 533
<b>COOPER</b> , agujas para ligaduras	216	<b>DE MARTEL-WOLFSON</b> , pinzas-clamps para anastomosis	532, 533
Copas graduadas	556, 559	<b>DEAN</b> , tijeras para encias	136
<b>CORNEAL (TROUTMAN)</b> , pinzas para iris	82	<b>DEAN</b> , tijeras tungsteno TUC	162
Cortador eléctrico para vendajes duros	321, 322	<b>DEAN-DELICATE</b> , tijeras para encias	136
Cortador eléctrico para vendajes duros OSCInopa	321	<b>DEAVER</b> , separadores	269-271
<b>CORWIN</b> , pinzas para torcer hilos con hilos TUC	403	<b>DEAVER</b> , tijeras para cirugía	104
<b>CORWIN</b> , pinzas para torcer hilos tungsteno TUC	203	<b>DEJERINE</b> , martillos de percusión	370
<b>CORYLLOS</b> , separadores	274	<b>DEMEL</b> , tensores cierra-hilos	407
<b>COTTLE KAZANJIAN</b> , pinzas cortantes para huesos	477	<b>DENIS-BROWNE</b> , separadores abdominales	301
<b>COTTLE</b> , martillos	428	<b>DERF</b> , porta-agujas	180
<b>COTTLE</b> , pinzas nasales	77	<b>DERF</b> , porta-agujas tungsteno TUC	195
<b>COTTLE</b> , tijeras nasales	120	<b>DERF-CONVERSE</b> , porta-agujas	180
<b>COUPLAND</b> , tubos de aspiración	332	Dermatomo	176
<b>COUPLAND</b> , tubos de aspiración	337	<b>DESCHAMPS</b> , agujas para ligaduras	215
<b>CRAFOORD</b> , pinzas-clamps bronquiales	30	<b>DESJARDINS</b> , pinzas-clamps para conducto biliar	40
<b>CRAFOORD</b> , tijeras	118	<b>DESMARRES</b> , ganchos	248
<b>CRAFOORD-SELLORS</b> , pinzas para aurícula	29	<b>DESMARRES</b> , pinzas de chalazión	88
<b>CRANE-KAPLAN</b> , pinzas para bolsas	98	Desobliteradores de vasos	315
<b>CREGO</b> , elevadores para huesos	398	Destomilladores	491
<b>CRILE</b> , pinzas hemostáticas	17	Diagnostico	367-382
<b>CRILE</b> , porta-agujas	187	<b>DICK</b> , pinzas para anastomosis	528
<b>CRILE-MURRAY</b> , porta-agujas	182	<b>DIEFFENBACH</b> , bisturíes para abscesos	174
<b>CRILE-RANKIN</b> , pinzas hemostáticas	17	<b>DIEFFENBACH</b> , bisturíes para operaciones	170, 171
<b>CRILE-WOOD</b> , porta-agujas	182	<b>DIEFFENBACH</b> , clamps bulldog	11
<b>CRILE-WOOD</b> , porta-agujas tungsteno TUC	196	<b>DIETRICH</b> , micro-porta-agujas tungsteno TUC	205
<b>CRILE-WOOD-BABY</b> , porta-agujas	182	<b>DIETRICH-HEGEMANN</b> , tijeras para cirugía vasculares	114
<b>CRILE-WOOD-BABY</b> , porta-agujas tungsteno TUC	196	Dilatadores para vasos	72
Cubeta universal	561	Dilatadores vasculares	313, 314
Cubetas	559, 561, 562	Dinamómetros	374
Cubetas para soluciones	562	<b>DINGMANN</b> , pinzas para cartilago	453
Cubetas redonda	559	<b>DIPLOMAT</b> , manómetro para la presión de la sangre	379
Cucharillas cortantes	434-441	<b>DISSECTION</b> , micro-tijeras	145, 147
Cuchillos para amputación	172	<b>DIXON-LOVELACE</b> , pinzas hemostáticas	26
Cuchillos para cerebro	173	<b>DOUGLAS</b> , pinzas depilatorias	76
Cuchillos para órganos	173	<b>DOUGLAS</b> , trocares	330
Cuchillos para transplantación	175	<b>DOUGLAS-BOZEMANN</b> , pinzas para tapones	233
Cuchillos para vendajes enyesados	318	<b>DOYEN</b> , martillos	428
<b>CULLEN-WERTHEIM</b> , pinzas-clamps para histerectomía	44	<b>DOYEN</b> , pinzas de campo	51
Cunas	559	<b>DOYEN</b> , pinzas para compresas	51
Curetas	434-441	<b>DOYEN</b> , pinzas-clamps estomacales y intestinales	520, 524
<b>CUSHING</b> , ganchos	244, 248	<b>DOYEN</b> , pinzas-clamps estomacales y intestinales Atrauma	524
<b>CUSHING</b> , perforadores de mano	387	<b>DOYEN</b> , porta-agujas	180
<b>CUSHING</b> , pinzas de disección	62	<b>DOYEN</b> , raspadores	445
<b>CUSHING</b> , pinzas de disección con dientes	62	<b>DOYEN</b> , separadores	267
<b>CUSHING</b> , pinzas de disección tungsteno TUC	93	<b>DOYEN</b> , separadores abdominales	302
<b>CUSHING</b> , separadores espinales	250	<b>DOYEN</b> , sondas	310
<b>CUSHING-TAYLOR</b> , pinzas de disección tungsteno TUC	93	<b>DOYEN</b> , tijeras	106
<b>CZERNY</b> , espéculos rectales	534	<b>DOYEN-STILLE</b> , separadores	266
<b>CZERNY</b> , separadores	279	<b>DUBOIS</b> , tijeras para ginecología	107
<b>D</b>		<b>DUEHRSSSEN</b> , pinzas de disección	64
<b>DAHMEN</b> , cinceles	425	<b>DUEHRSSSEN</b> , pinzas de disección con dientes	64
<b>DAHMEN</b> , gubias	425	<b>DUNHILL</b> , pinzas hemostáticas	22
<b>DANDY</b> , pinzas hemostáticas para pericráneo	26	<b>DUPLAY</b> , pinzas para pólipos	236
<b>DANDY</b> , tijeras para cirugía vasculares	115	<b>DUPLEX-LIGHTWEIGHT/BABY</b> , estetoscopios	378
<b>DARLING</b> , separadores autoestáticos	295	<b>DURANTE</b> , pinzas para coger	68
<b>DAVIDSON</b> , separadores	276	<b>DUVAL</b> , pinzas para coger	68
<b>DAVIS-RAGNELL</b> , separadores finas	250	<b>DUVAL</b> , pinzas para coger intestinos	519
<b>DE BAKEY</b> , dilatadores vasculares	314	<b>DUVAL-COLLIN</b> , pinzas para coger	66
		<b>DYNAMOMETER III</b>	374



## E

<b>EASTMAN-RICHARDSON</b> , separadores	264
<b>EATON-BECKMANN</b> , separadores autoestáticos	293
<b>ECHLIN</b> , pinzas-gubias	474
<b>ECONOM</b> , juegos para diagnóstico	380
<b>EICKEN</b> , trocares	330
<b>EICKEN-CLAUS</b> , agujas para ligaduras	219
<b>EICKEN-KILLIAN</b> , tubos de aspiración	335
<b>EISELSBERG</b> , tijeras para ligaduras	128
Elevadores	447-449, 481
Elevadores para huesos	395-398
<b>ELSCHNIG</b> , pinzas de fijación	84
<b>ENGEL</b> , sierras para vendajes enyesados	318
<b>ENGL. MODELL</b> , pinzas de campo	51
<b>ENGL. MODELL</b> , pinzas para compresas	51
<b>ERHARDT</b> , pinzas entropión	88
Escofinas	451
Esfinteroscopios	537-541
<b>ESMARCH</b> , cuchillos para vendajes enyesados	318
<b>ESMARCH</b> , tijeras para vendajes	134
Espátulas abdominales	308
Espéculos rectales	534-536
Espejos frontales	367
Estetoscopios	377, 378
Estribos para extensión	399, 400
Estuches para esterilizar agujas	560
<b>EUFRATE PASQUE</b> , porta-agujas TUC	193
<b>EWALD</b> , pinzas de disección	60
<b>EWALD</b> , pinzas de disección con dientes	60
<b>EXCENTRIC-LISTER</b> , tijeras para vendajes	133

## F

<b>FALK</b> , agujas para ligaduras	219
<b>FARABEUF</b> , pinzas para huesos	458
<b>FARABEUF</b> , raspadores	443
<b>FARABEUF</b> , separadores	278
<b>FARABEUF-LAMBOTTE</b> , pinzas para huesos	458
<b>FARRELL</b> , porta-algodones	311
<b>FAULKNER</b> , pinzas para tener cristalino	90
<b>FAURE</b> , pinzas-clamps para histerectomía	45
<b>FAURE</b> , pinzas-clamps para peritoneo	50
<b>FAVALORO</b> , tijeras para cirugía vasculares	115
<b>FEHLAND</b> , pinzas-clamps estomacales y intestinales	527
<b>FEILCHENFELD</b> , pinzas para espinas	73
<b>FEIN</b> , porta-algodones	312
<b>FERGUSSON</b> , pinzas para huesos	455
<b>FERGUSSON</b> , pinzas-clamps de presión progresiva	47
<b>FERGUSSON</b> , tijeras para cirugía	104
<b>FERGUSSON</b> , tubos de aspiración	335
<b>FERREIRA</b> , separadores con iluminación de luz fría	280
<b>FERRIS-SMITH</b> , pinzas de disección con dientes	65
<b>FERROZELL</b> , sondas conductoras	222
<b>FERROZELL-BRUNNER</b> , sondas conductoras	222
<b>FERROZELL-KIRSCHNER</b> , sondas conductoras	222
<b>FINOCCHIETTO</b> , pinzas-clamps para pedúnculos renales	37
<b>FINOCCHIETTO</b> , porta-agujas	185
<b>FINOCCHIETTO</b> , porta-agujas tungsteno TUC	197
<b>FINOCCHIETTO</b> , tijeras	118
<b>FINSEN</b> , separadores autoestáticos	283
<b>FISCHER-ARLT</b> , pinzas para iris	80
<b>FLAGG</b> , pinzas para algodón y curaciones	96
<b>FLETCHER</b> , pinzas para esponjas	232
<b>FOERSTER</b> , pinzas para iris	81
<b>FOERSTER-BALLENGER</b> , pinzas para esponjas	237
<b>FOMON</b> , tijeras nasales	119
<b>FOMON</b> , tijeras para preparaciones	111
<b>FOREGGER (WISCONSIN)</b> , Fibre Optic laringoscopios	358

<b>FOREGGER (WISCONSIN)</b> , laringoscopios	354
<b>FOX</b> , cucharillas cortantes	436
<b>FOX-GOLDMAN (SPEZIAL)</b> , tijeras para encias	136
<b>FOX-GOLDMAN</b> , tijeras para encias	136
<b>FOX-GOLDMAN</b> , tijeras tungsteno TUC	161
<b>FRANKENFELDT</b> , pinzas para coger	316
<b>FRANZ</b> , separadores abdominales	302
<b>FRAZIER</b> , ganchos	242
<b>FRAZIER</b> , tubos de aspiración	335
<b>FREER</b> , elevadores	448
<b>FRENCH-EYE/RYDER</b> , porta-agujas tungsteno TUC	193
<b>FRIEDMAN</b> , pinzas-gubias	468
<b>FRIEDRICH</b> , instrumentas ligaduras	223
<b>FRITSCH</b> , separadores	266
<b>FRYKHOLM</b> , pinzas-gubias	474
<b>FUCHS-GILL</b> , pinzas para iris	83
<b>FULTON</b> , tijeras para cirugía vasculares	117

## G

Ganchos	242-250
<b>GARRETT</b> , dilatadores vasculares	313
<b>GEISSENDOERFER-OVERHOLT</b> , pinzas para preparaciones y ligaduras	23
<b>GELPI</b> , separadores autoestáticos	294
<b>GEMINI</b> , pinzas para preparaciones y ligaduras	35
<b>GERALD</b> , pinzas de disección	62
<b>GERALD</b> , pinzas de disección con dientes	62
<b>GERSTER</b> , clamp sujetador de huesos	394
<b>GERSTER-LOWMAN</b> , clamp sujetador de huesos	394
<b>GILL</b> , pinzas capsulares	83
<b>GILL-FUCHS</b> , pinzas para iris	83
<b>GILL-HESS</b> , pinzas para iris	82
<b>GILLIES</b> , ganchos	242
<b>GILLIES</b> , pinzas de disección con dientes	67
<b>GILLIES</b> , pinzas de disección tungsteno TUC	92
<b>GILLIES</b> , porta-agujas	185
<b>GILLIES</b> , porta-agujas tungsteno TUC	198
<b>GILLS-WELSH</b> , pinzas-tijeras para capsulotomía	140
<b>GIL-VERNET</b> , ganchos	249
<b>GOELET</b> , separadores	279
<b>GOLDMAN-FOX (SPEZIAL)</b> , tijeras para encias	136
<b>GOLDMAN-FOX</b> , tijeras para encias	136
<b>GOLDMAN-FOX</b> , tijeras tungsteno TUC	161
Goniómetros	373
<b>GOOD</b> , tijeras para amígdalas	119
<b>GOOD-SCHWECKENDICK</b> , tijeras para amígdalas	119
<b>GORNEY</b> , pinzas para preparaciones	111
<b>GOSSET</b> , separadores abdominales	298
<b>GRADLE</b> , pinzas depilatorias	76
<b>GRAEFE</b> , ganchos	243
<b>GRAEFE</b> , pinzas de fijación	84
<b>GRAEFE</b> , pinzas para iris	79
<b>GRAEFE</b> , tijeras oculares	126
Grapas	496
<b>GRAY</b> , pinzas-clamps para conducto biliar	40
<b>GRAZIL</b> , tijeras para cirugía	103
<b>GREEN</b> , pinzas de fijación	84
<b>GREEN-SENN</b> , ganchos	247
<b>GROSS-MAIER</b> , pinzas para pólipos	230, 231
<b>GRUENWALD (JANSEN)</b> , pinzas nasales	78
<b>GRUENWALD</b> , pinzas nasales	78
Gubias	417-426
<b>GUTHRIE</b> , ganchos	246
<b>GUYON</b> , pinzas-clamps para pedúnculos renales	38, 39
<b>GUYON-ARTRAUMATIC</b> , pinzas-clamps para pedúnculos renales	39

## H

<b>HABERER</b> , espátulas abdominales	308
--	-----

	Página		Página
<b>HAJEK</b> , martillos	429	Instrumentos para medidas	371-375
<b>HALLE</b> , tijeras nasales	120	Instrumentos sensibilidad	376
<b>HALSEY</b> , porta-agujas	181	<b>IOWA</b> , agujas especiales	345
<b>HALSEY</b> , porta-agujas tungsteno TUC	195	<b>ISRAEL</b> , separadores	253
<b>HALSTED</b> , pinzas hemostáticas	16	<b>IVES-FANSLER</b> , esfinteroscopios	538
<b>HALSTED-MOSQUITO</b> , pinzas hemostáticas	15	<b>IWANSON</b> , círculo	375
<b>HARMAN-BISHOP</b> , pinzas para iris	82		
<b>HARMS</b> , pinzas para sutura	86	<b>J</b>	
<b>HARRINGTON</b> , separadores	267	<b>JACKSON</b> , laringoscopios con luz fría	363
<b>HARRISON (PYE-SMITH)</b> , pinzas para esterilización	564	<b>JACKSON</b> , pinzas para compresas y tamponamientos	78
<b>HARTMANN</b> , pinzas hemostáticas	14	<b>JACOBI</b> , agujas para ligaduras	217
<b>HARTMANN</b> , pinzas-gubias	469	<b>JACOBS CHUCK</b> , perforadores de mano	388
<b>HARVEY</b> , cizallas para cortar alambre	130	<b>JACOBSON</b> , micro-porta-agujas	210
<b>HATFIELD</b> , cucharillas cortantes	439	<b>JACOBSON</b> , micro-porta-agujas tungsteno TUC	204
<b>HEANEY</b> , pinzas-clamps para histerectomía	43	<b>JACOBSON</b> , porta-agujas	182
<b>HEANEY</b> , porta-agujas	184	<b>JACOBSON</b> , porta-agujas tungsteno TUC	194
<b>HEANEY</b> , separadores	277	<b>JAMESON</b> , calibre micrometro	372
<b>HEANEY-BALLANTINE</b> , clamps para histerectomía	43	<b>JAMESON</b> , pinzas musculares	87
<b>HEANEY-KANTER</b> , clamps para histerectomía	43	<b>JAMESON</b> , porta-agujas	184
<b>HEANEY-REZAK</b> , clamps para histerectomía	44	<b>JANET</b> , jeringas	348
<b>HEATH</b> , tijeras para ligaduras	129	<b>JANSEN (GRUENWALD)</b> , pinzas nasales	78
<b>HEATH-RICHTER</b> , pinzas para agrafes	224	<b>JANSEN</b> , cucharillas cortantes	440
<b>HEGAR-OLSEN</b> , porta-agujas	185	<b>JANSEN</b> , pinzas nasales	77
<b>HEGAR-OLSEN</b> , porta-agujas tungsteno TUC	198	<b>JANSEN</b> , separadores autoestaticos	284
<b>HEGEMANN-DIETRICH</b> , tijeras para cirugía vasculares	114	Jeringas	348
<b>HEGENBARTH</b> , pinzas para agrafes	224	Jeringas para cartucho ampullas	347
<b>HEIFETZ</b> , pinzas para coger	70	<b>JEWELER</b> , pinzas de disección tungsteno TUC	92
<b>HEISS</b> , pinzas hemostáticas	30	<b>JOBSON-HORNE</b> , porta-algodones	312
<b>HELFERICH-BIER</b> , sierras para amputación	384	<b>JOHANSSON</b> , trocates	329
<b>HEMINGWAY</b> , cucharillas cortantes	441	<b>JOHNS-HOPKINS</b> , clamps bulldog	11
<b>HENAHAN</b> , ganchito retractor de la muela del juicio	481	<b>JOHNS-HOPKINS</b> , pinzas para poner	11
<b>HENLEY</b> , separadores autoestaticos	288	<b>JOHNS-HOPKINS</b> , pinzas para preparaciones y ligaduras	32
<b>HENNIG</b> , separadores para escayola	319	<b>JONES</b> , pinzas de campo	51
<b>HERRICK</b> , pinzas-clamps para pedúnculos renales	39	<b>JONES</b> , pinzas para compresas	51
<b>HESS</b> , pinzas para iris	81	<b>JOSEPH</b> , ganchos	246
<b>HESSBERG</b> , agujas para ligaduras	217	<b>JOSEPH</b> , tijeras para preparaciones	112
<b>HESS-GILL</b> , pinzas para iris	82	<b>JUDD-ALLIS</b> , pinzas para coger tejidos y intestinos	518
<b>HEYMANN</b> , tijeras nasales	120	Juegos para diagnóstico	380, 381
<b>HEYWOOD-SMITH</b> , pinzas para esponjas	236		
<b>HIBBS</b> , cinceles	420	<b>K</b>	
<b>HIBBS</b> , gubias	420	<b>KADER</b> , separadores	273
<b>HIRSCHMANN</b> , anoscopios	539	<b>KALT</b> , micro-porta-agujas	212
<b>HOEN</b> , elevadores	448	<b>KALT</b> , micro-porta-agujas tungsteno TUC	205
<b>HOESEL</b> , separadores	265	<b>KALT-ARRUGA</b> , micro-porta-agujas	212
<b>HOHMANN</b> , elevadores para huesos	396, 397	<b>KALT-CASTROVIEJO</b> , micro-porta-agujas	212
Hojas de afeitar	177	<b>KANTER-HEANEY</b> , pinzas-clamps para histerectomía	43
Hojas de bisturíes	167, 168	<b>KANTROWITZ</b> , pinzas para preparaciones y ligaduras	35
Hojas de sierra para cortador eléctrico	323	<b>KAPLAN-CRANE</b> , pinzas para bolsas	98
<b>HOKE</b> , gubias	417	<b>KATZIN</b> , pinzas-tijeras para córnea	142
<b>HOLINGER</b> , laringoscopios	362	<b>KATZIN-BARRAQUER</b> , pinzas tijeras para córnea	142
<b>HOPKINS</b> , cuchillos para vendajes enyesados	318	<b>KAYE</b> , tijeras para Face-lift TUC	161
<b>HOPKINS-JOHNS</b> , clamps bulldog	11	<b>KELLY (RICHARDSON)</b> , separadores	264
<b>HOPKINS-JOHNS</b> , pinzas para poner	11	<b>KELLY</b> , pinzas hemostáticas	17
<b>HOPKINS-JOHNS</b> , pinzas para preparaciones y ligaduras	32	<b>KELLY</b> , pinzas para esponjas	235
<b>HORNE-JOBSON</b> , porta-algodones	312	<b>KELLY</b> , proctoscopios	540, 541
<b>HÖSEL</b> , porta-agujas	188	<b>KELLY</b> , separadores	268
<b>HÖSEL</b> , porta-agujas tungsteno TUC	201	<b>KELLY</b> , tijeras para fistulas	106
<b>HOSPITAL-PROVIDENCE</b> , pinzas hemostáticas	16	<b>KELLY</b> , tijeras tungsteno TUC	153
<b>HRYNTSCHAK-YOUNG</b> , boomerang porta-agujas	189	<b>KELLY-RANKIN</b> , pinzas hemostáticas	17
<b>HUDSON</b> , perforadores de mano	387	<b>KELMAN-McPHERSON</b> , pinzas para sutura	85
<b>HUMBY</b> , dermatomo	176	<b>KERN</b> , pinzas para huesos	456
<b>HUNT</b> , pinzas para coger	70	<b>KERSTING</b> , pinzas para anastomosis	528
<b>HUNTER</b> , pinzas para espinas	73	<b>KILNER (RAGNELL)</b> , tijeras para preparaciones	112
<b>HURD</b> , agujas para ligaduras	218	<b>KILNER</b> , ganchos	242
		<b>KILNER</b> , porta-agujas	181
<b>I</b>		<b>KILNER</b> , porta-agujas tungsteno TUC	195
Instrumentos para clavos Küntscher	488, 489	<b>KIRBY</b> , pinzas para iris	82
Instrumentos para coger tendones	464		



	Página		Página
<b>KIRSCHNER</b> , agujas	499-502	<b>LANGENBECK-MINI</b> , ganchos	247
<b>KIRSCHNER</b> , estribos para extensión	400	<b>LANGENBECK-PARKER</b> , separadores	278
<b>KIRSCHNER</b> , separadores abdominales	303	<b>LANGENBECK-RYDER</b> , porta-agujas tungsteno TUC	202
<b>KIRSCHNER</b> , sondas conductoras	222	Laringoscopios	353-360
<b>KIRSCHNER</b> , tubos de aspiración	503	Laringoscopios con luz fría	357-360
<b>KIRSCHNER-FERROZELL</b> , sondas conductoras	222	<b>LAWRENCE</b> , pinzas para preparaciones y ligaduras	34
<b>KLEINERT-KUTZ</b> , ganchos	242	<b>LEKSELL-STILLE</b> , pinzas-gubias	473
<b>KLEINERT-KUTZ</b> , instrumentos para coger tendones	464	<b>LEMPERT</b> , pinzas-gubias	470
<b>KLEINERT-KUTZ</b> , pinzas-gubias	471	<b>LERICHE</b> , pinzas hemostáticas	16
<b>KLIMA-ROSSEGER</b> , agujas para biopsia	343	<b>LESTER</b> , pinzas de fijación	84
<b>KLINIKUM BERLIN</b> , pinzas para tubos	53	<b>LEWIN</b> , pinzas para huesos	454
<b>KLINKENBERGH-LOTH</b> , tijeras para cirugía vasculares	117	<b>LEXER</b> , cinceles	422, 423
<b>KNAPP</b> , ganchos	246	<b>LEXER</b> , gubias	422, 423
<b>KNIGHTON</b> , separadores autoestáticos	297	<b>LEXER</b> , tijeras para preparaciones	111
<b>KNOWLES</b> , tijeras para vendajes	133	<b>LEXER</b> , tijeras tungsteno TUC	158
<b>KOCHER</b> , agujas para ligaduras	216	<b>LEXER-BABY</b> , tijeras para preparaciones	111
<b>KOCHER</b> , pinzas-clamps estomacales y intestinales	522, 525	<b>LICHTENBERG</b> , porta-agujas	187
<b>KOCHER</b> , pinzas-clamps estomacales y intestinales Atrauma	525	<b>LICHTENBERG</b> , porta-agujas tungsteno TUC	201
<b>KOCHER</b> , retractores	260, 266	<b>LICHTWITZ</b> , trocares	330
<b>KOCHER</b> , separadores	251, 260, 266	Ligadores hemorroides	552-554
<b>KOCHER</b> , sondas conductoras	222	Limas de unas	579
<b>KOCHER-DELICATE</b> , pinzas hemostáticas	22	Limas para huesos	450
<b>KOCHER-LANGENBECK</b> , separadores	259	<b>LINCOLN</b> , tijeras para cirugía vasculares	117
<b>KOCHER-OCHSNER</b> , pinzas hemostáticas	20, 21	<b>LINDEMANN</b> , sierras para resección	384
<b>KOERTE</b> , separadores	252, 267	<b>LISTER</b> , pinzas para tapones	229
<b>KÖNIG</b> , sondas conductoras	221	<b>LISTER</b> , tijeras para vendajes	133, 134
<b>KÖNIG</b> , tijeras para unas encarnadas	135	<b>LISTER</b> , tijeras tungsteno TUC	162
<b>KRAUSE</b> , trocares	330	<b>LISTER-EXCENTRIC</b> , tijeras para vendajes	133
<b>KROENLEIN</b> , pinzas para coger	13	<b>LISTON</b> , cuchillos para amputación	172
<b>KRONECKER</b> , agujas para ligaduras	218	<b>LISTON</b> , pinzas cortantes para huesos	477, 480
<b>KUEHNE</b> , pinzas porta-laminillas	78	<b>LISTON-KEY</b> , pinzas cortantes para huesos	479
<b>KÜNTSCHER</b> , clavos intramedulares	492-494	<b>LITTAUER</b> , pinzas corta-unas	569
<b>KÜNTSCHER</b> , instrumentos para clavos	488, 489	<b>LITTAUER</b> , pinzas depilatorias	76
<b>KUTZ-KLEINERT</b> , ganchos	242	<b>LITTAUER</b> , tijeras para ligaduras	128
		<b>LITTAUER-LISTON</b> , pinzas cortantes para huesos	477
<b>L</b>		<b>LITTLE</b> , separadores	263
<b>LA GRANGE</b> , tijeras oculares	126	<b>LITTLER</b> , tijeras finas	123
<b>LAHEY</b> , pinzas-clamps para conducto biliar	37	<b>LITTLEWOOD</b> , pinzas per coger tejidos y intestinos	518
<b>LAHEY</b> , separadores	263	Llaves	349
<b>LAMBOTTE</b> , gubias	426	<b>LLOYD-DAVIS</b> , pinzas para anastomosis	529
<b>LAMBOTTE</b> , pinzas para huesos	460	<b>LOCKHART-MUMMERY</b> , sondas	311
<b>LAMBOTTE</b> , raspadores	443	<b>LOCKLIN</b> , tijeras para encias	136
Lámparas de alcohol	556	<b>LOCKLIN</b> , tijeras tungsteno TUC	162
Lámparas frontales	368	<b>LOCKWOOD</b> , pinzas para coger tejidos y intestinos	518
<b>LAMPERT</b> , pinzas de chalazión	89	<b>LOCKWOOD-ALLIS</b> , pinzas para coger tejidos y intestinos	518
<b>LANDAU</b> , trocares	329	<b>LONDON-COLLEGE</b> , pinzas para algodón y curaciones	95
<b>LANDAU-SEGOND</b> , pinzas-clamps para histerectomía	45	<b>LONG</b> , pinzas-clamps para histerectomía	44
<b>LANDGRAF</b> , pinzas para algodón y curaciones	97	<b>LORENZ</b> , tijeras para vendajes	133
<b>LANDOLT</b> , tijeras finas	124	<b>LORNA</b> , pinzas de campo	52
<b>LANE</b> , destomilladores	491	<b>LORNA</b> , pinzas para compresas	52
<b>LANE</b> , pinzas de campo	51	<b>LOTH-KLINKENBERGH</b> , tijeras para cirugía vasculares	117
<b>LANE</b> , pinzas de disección	61	<b>LOTH-SCHOEMAKER</b> , tijeras para ligaduras	128
<b>LANE</b> , pinzas para compresas	51	<b>LOUTE</b> , tensores cierra-hilos	407
<b>LANE</b> , pinzas para huesos	457	<b>LOVELACE-DIXON</b> , pinzas hemostáticas	26
<b>LANE</b> , pinzas-clamps estomacales	531	<b>LOWER</b> , pinzas-clamps para conducto biliar	37
<b>LANGE</b> , pinzas para agrafes	225	<b>LUCAE</b> , martillos	430
<b>LANGE</b> , tijeras para vestidos	132	<b>LUCAE</b> , pinzas nasales	77
<b>LANGE-HOHMANN</b> , elevadores para huesos	397	<b>LUCAS</b> , chucharillas cortantes	441
<b>LANGENBECK</b> , cuchillos para amputación	172	<b>LUCAS</b> , cinceles	417
<b>LANGENBECK</b> , elevadores	447	<b>LUER</b> , pinza hemorroidales, atrauma	48
<b>LANGENBECK</b> , pinzas para huesos	455	<b>LUER</b> , pinzas-gubias	469
<b>LANGENBECK</b> , porta-agujas	188	<b>LUER</b> , tubos de aspiración	336
<b>LANGENBECK</b> , porta-agujas tungsteno TUC	202	<b>LUETHY-BECK</b> , porta-agujas tungsteno TUC	202
<b>LANGENBECK</b> , raspadores	443		
<b>LANGENBECK</b> , separadores	254, 258	<b>M</b>	
<b>LANGENBECK</b> , sierras para resección	384	<b>MAGILL</b> , pinzas para catéteres	360
<b>LANGENBECK-DELICATE</b> , porta-agujas tungsteno TUC	202	<b>MAIER-GROSS</b> , pinzas para pólipos	230, 231
<b>LANGENBECK-KOCHER</b> , separadores	259	<b>MAIER-SIMS</b> , pinzas para pólipos	239

	Página		Página
Mangos de bisturíes	165-167	<b>MEYERDING</b> , separadores	273
Mangos de pila (sin pilas)	356	<b>MEYERDING</b> , separadores autoestáticos	294
Mangos de pila (sin pilas) Fibre Optic	360	<b>MEYERDING-MARKHAM</b> , separadores autoestáticos	294
Mangos para cánulas de liposucción y infiltración	338, 340	<b>MICHEL</b> , agrafes	225
Manómetros para la presión de la sangre	379	<b>MICHEL</b> , pinzas para agrafes	224
Manoplas de plomo	482	Micro- pinzas	71, 72
Marcador para Facelift	376	Micro, porta-agujas	204-213
<b>MARKHAM-MEYERDING</b> , separadores autoestáticos	294	Micro, tijeras	143-149
<b>MARKWALDER</b> , pinzas cortantes para huesos	477	Micro, tijeras Adventitia	145, 147
<b>MARQUARDT</b> , pinzas-gubias	470	Micro, tijeras Dissection	145, 147
<b>MARTEL</b> , pinzas hemostáticas para pericráneo	12	Micro, tijeras nerve	147
<b>MARTEL-WILLET</b> , pinzas hemostáticas para pericráneo	12	<b>MICRO-ADSON</b> , pinzas de disección	59
Martillos	427-433	<b>MICRO-ADSON</b> , pinzas de disección con dientes	59
Martillos de percusión	369, 370	<b>MICRO-FRIEDMAN</b> , pinzas-gubias	476
<b>MARTIN</b> , pinzas para cartilago	453	<b>MICRO-MOSQUITO</b> , pinzas hemostáticas	15
<b>MARTIN</b> , separadores	262	Micro-porta-agujas con mango redondo	206-209
<b>MARTIN-CARTILAGE</b> , tijeras	118	<b>MICRO-RYDER</b> , porta-agujas tungsteno TUC	193
<b>MARTINI</b> , cucharillas cortantes	440	<b>MICROVASCULAR</b> , porta-agujas TUC	193
<b>MASS.-GENERAL-HOSPITAL (M.G.H.)</b> , porta-agujas	183	<b>MICRO-WULLSTEIN</b> , tubos de aspiración	335
<b>MASSE-ROBIN</b> , separadores abdominales	306	<b>MIDDELDORPF</b> , separadores	264
<b>MASSON</b> , porta-agujas	184	<b>MIKULICZ</b> , pinzas-clamps para peritoneo	49
<b>MASSON</b> , porta-agujas tungsteno TUC	197	<b>MIKULICZ</b> , separadores	268
<b>MATHIEU</b> , espéculos rectales	536	<b>MIKULICZ-BABY</b> , pinzas-clamps para peritoneo	49
<b>MATHIEU</b> , porta-agujas	186	<b>MILLER</b> , Fibre Optic laringoscopios	359
<b>MATHIEU</b> , porta-agujas tungsteno TUC	199	<b>MILLER</b> , laringoscopios	355
<b>MATHIEU</b> , separadores	278	<b>MILLER</b> , pinzas para papel de articular	98
<b>MATHIEU-DELICATE</b> , porta-agujas	186	<b>MILLER-SENN</b> , separadores finas	250
<b>MATHIEU-DELICATE</b> , porta-agujas tungsteno TUC	199	<b>MILLIGAN</b> , separadores autoestáticos	288
<b>MATHIEU-RYDER VASCULAR</b> , porta-agujas tungsteno TUC	200	<b>MILLS</b> , tijeras para cirugía vasculares	116
<b>MATHIEU-RYDER</b> , porta-agujas tungsteno TUC	200	<b>MINI</b> , hojas de bisturíes	167
<b>MATSON</b> , raspadores	446	<b>MINI</b> , mangos de bisturíes	167
<b>MAYFIELD</b> , pinzas-gubias	470	<b>MINI-FRIEDMAN</b> , pinzas-gubias	468
<b>MAYO ROBSON</b> , pinzas-clamps estomacales y intestinales Atrauma	526	<b>MINI-HOHMANN</b> , elevadores para huesos	395
<b>MAYO</b> , cadres de esterilización	564	<b>MINI-LAMBOTTE</b> , gubias	426
<b>MAYO</b> , tijeras	105	<b>MINI-LANGENBECK</b> , ganchos	247
<b>MAYO</b> , tijeras tungsteno TUC	153	<b>MINI-LEXER</b> , cinceles	422
<b>MAYO-ADAMS</b> , separadores autoestáticos	296	<b>MINI-LEXER</b> , gubias	422
<b>MAYO-HARRINGTON</b> , tijeras	105	<b>MISKIMON</b> , separadores autoestáticos	289
<b>MAYO-HEGAR</b> , porta-agujas	184	<b>MIXTER</b> , pinzas para preparaciones y ligaduras	33, 34
<b>MAYO-HEGAR</b> , porta-agujas tungsteno TUC	192	<b>MIXTER</b> , tijeras para cirugía	104
<b>MAYO-HEGAR-DELICATE</b> , porta-agujas	184	<b>MIXTER-BABY</b> , pinzas para preparaciones y ligaduras	33
<b>MAYO-HEGAR-DELICATE</b> , porta-agujas tungsteno TUC	192	<b>MIXTER-O'SHAUGNESSY</b> , pinzas para preparaciones y ligaduras	33
<b>MAYO-NOBLE</b> , tijeras	105	<b>MIXTER-OVERHOLT</b> , pinzas para preparaciones y ligaduras	29
<b>MAYO-ROBSON</b> , pinzas-clamps estomacales y intestinales	521, 526	<b>MOD. BONN</b> , pinzas para iris	81
<b>MAYO-RUSS</b> , pinzas para coger	66	<b>MOD. BONN</b> , pinzas para sutura	86
<b>MAYO-STILLE</b> , tijeras	105	<b>MOD. BONN</b> , tijeras finas	124
<b>MAYO-STILLE</b> , tijeras tungsteno TUC	154	<b>MOD. TÛBINGEN (VANNAS)</b> , pinzas-tijeras para catarata secundaria	139
<b>MC GIVNEY</b> , ligadores hemorroides	553	<b>MOD. TÛBINGEN</b> , pinzas para sutura	86
<b>MC INDOE</b> , pinzas cortantes para huesos	478	<b>MOD. USA (SMITH)</b> , tijeras para vendajes	133
<b>MC INDOE</b> , pinzas de disección	60	<b>MOD. USA</b> , separadores para escayola	319
<b>MC INDOE</b> , tijeras	118	<b>MOD. USA</b> , tijeras umbilicales	121
<b>MC INTOSH</b> , Fibre Optic laringoscopios	357	<b>MOD. WIEN</b> , instrumentas ligaduras	223
<b>MC INTOSH</b> , laringoscopios	353	<b>MODELL TÛBINGEN</b> , separadores	262
<b>McDONALD</b> , elevadores	448	<b>MODELL USA</b> , pinzas de disección	59
<b>McDONALD</b> , pinzas capsulorhexis	90	<b>MODELL USA</b> , pinzas de disección con dientes	59
<b>McPHERSON</b> , pinzas para sutura	85	<b>MOELTGEN</b> , goniómetros	373
<b>MEAD</b> , martillos	430	<b>MOLDESTADT</b> , ganchos	244
<b>MEAD</b> , pinzas-gubias	469	<b>MOLLISON</b> , separadores autoestáticos	289
<b>MEEKER</b> , pinzas para preparaciones y ligaduras	25	<b>MOLT</b> , raspadores	444
<b>MENGHINI</b> , agujas para biopsia	344	<b>MOORE</b> , perforadores de mano	387
<b>MERIAM</b> , pinzas para algodón y curaciones	96	<b>MOORFIELD</b> , pinzas para sutura	84
<b>METZENBAUM</b> , porta-agujas tungsteno TUC	199	<b>MORGAN</b> , anoscopios	541
<b>METZENBAUM</b> , tijeras para preparaciones	108	<b>MORGAN</b> , luz fría	541
<b>METZENBAUM</b> , tijeras tungsteno TUC	155, 156	<b>MORRIS</b> , separadores	261
<b>METZENBAUM-BABY</b> , tijeras para preparaciones	108	<b>MOSQUITO-HALSTED</b> , pinzas hemostáticas	15
<b>METZENBAUM-DELICATE</b> , tijeras para preparaciones	110	<b>MOSQUITO-MICRO</b> , pinzas hemostáticas	15
<b>METZENBAUM-DELICATE</b> , tijeras tungsteno TUC	158-160	<b>MOYNIHAN</b> , pinzas-clamps para histerectomía	44
<b>METZENBAUM-NELSON</b> , tijeras para preparaciones	109	Multiple approach retractor	282
<b>MEYERDING</b> , ganchos	247	<b>MUMMERY-LOCKHART</b> , sondas	311



<b>MYRTLE LEAF</b> , sondas	310	Pedicura	568-579
<b>N</b>		<b>PEERS</b> , pinzas de campo	52
<b>NABATOFF</b> , sondas para várices	312	<b>PEERS</b> , pinzas para compresas	52
<b>NAGER</b> , agujas para ligaduras	219	<b>PEET</b> , pinzas para espinas	75
<b>NEFF</b> , bisturíes para meniscos	467	<b>PELKMANN</b> , pinzas para tapones	235
<b>NEGUS</b> , pinzas-clamps para conducto biliar	40	<b>PENNINGTON</b> , pinzas para coger	13
<b>NEIVERT</b> , porta-agujas	181	<b>PERCY</b> , retractor para amputación	463
<b>NEIVERT</b> , porta-agujas tungsteno TUC	195	Perforadores de mano	385-390
<b>NELATON</b> , sondas	310	<b>PERRY</b> , pinzas para algodón y curaciones	97
<b>NELSON</b> , pinzas para coger	66	<b>PERTHES</b> , perforadores de mano	390
<b>NELSON</b> , trocares	328	<b>PHANEUF</b> , pinzas-clamps para histerectomía	45
<b>NELSON-METZENBAUM</b> , tijeras para preparaciones	109	<b>PHILIPS</b> , destornilladores	491
<b>NERVE</b> , micro tijeras	147	<b>PIERCE</b> , trocares	330
<b>NEUMANN</b> , tijeras para encias	137	Piezas de conexión	349
<b>NEW ORLEANS</b> , porta-agujas	183	<b>PIFFARD</b> , cucharillas cortantes	436
<b>NEW ORLEANS</b> , porta-agujas tungsteno TUC	194	<b>PINARD</b> , estetoscopios	377
<b>NIRO</b> , pinzas para hilos	401	Pinza-clamps para histerectomía	41-45
<b>NOBLE-MAYO</b> , tijeras	105	Pinza-clamps para peritoneo	49, 50
<b>nopa PROFI</b> , sierra para autopsia	484	Pinzas	57-98
<b>NORTHBENT</b> , tijeras para ligaduras	129	Pinzas atrauma	91
<b>NOTO</b> , pinzas para esponjas	234	Pinzas auriculares	77
<b>NOYES</b> , pinzas-tijeras para Iridectomia	138	Pinzas capsulares	83
<b>NUSSBAUM</b> , pinzas-clamps estomacales y intestinales	523	Pinzas capsulorhexis	90
		Pinzas cortantes para huesos	477-480
<b>O</b>		Pinzas de campo	51, 52
<b>O'BRIAN</b> , tijeras finas	124	Pinzas de chalazión	88, 89
<b>OBWEGESER</b> , separadores para el ramo	257	Pinzas de disección	57-65
<b>OBWEGESER</b> , separadores para partes blandes	255, 256	Pinzas de disección con dientes	67, 68
<b>OCHSNER</b> , trocares	329	Pinzas de disección tungsteno TUC	92-94
<b>OCHSNER-KOCHER</b> , pinzas hemostáticas	20, 21	Pinzas de entropión	88
<b>O'CONNOR</b> , ganchos	243	Pinzas de fijación	84
<b>O'CONNOR-O'SULLIVAN</b> , separadores abdominales	301	Pinzas de ligadura con plataforma	71, 72
<b>OEHLER</b> , pinzas de disección tungsteno TUC	92	Pinzas de protección	390
<b>OLIVECRONA</b> , tijeras para cirugía vasculares	117	Pinzas de relojero	69
<b>OLLIER</b> , separadores	253	Pinzas de reposición	487
<b>OLSEN-HEGAR</b> , porta-agujas	185	Pinzas de sutura	97
<b>OLSEN-HEGAR</b> , porta-agujas tungsteno TUC	198	Pinzas depilatorias	76
<b>OLSEN-HEGAR-USA</b> , porta-agujas tungsteno TUC	198	Pinzas hemorroidales	47, 48
<b>OMBREDANNE</b> , martillos	427	Pinzas hemorroidales, atrauma	48
<b>OSCINOPA</b> , cortador eléctrico para vendajes duros	321	Pinzas hemostáticas	9-53
<b>OSCINOPA</b> , sierra para autopsia	483	Pinzas hemostáticas	13-23, 25-28
<b>O'SHAUGNESSY-MIXTER</b> , pinzas para preparaciones y ligaduras	33	Pinzas hemostáticas delgadas	22
<b>O'SULLIVAN-O'CONNOR</b> , separadores abdominales	301	Pinzas hemostáticas finas	15
<b>OTOSKOP UNI</b> , juegos para diagnóstico	381	Pinzas hemostáticas para amígdalas	27
<b>OVERHOLT</b> , pinzas para preparaciones y ligaduras	24	Pinzas hemostáticas para pericráneo	12, 26
<b>OVERHOLT-BABY</b> , pinzas para preparaciones y ligaduras	23	Pinzas musculares	87, 88
<b>OVERHOLT-GEISSENDOERFER</b> , pinzas para preparaciones y ligaduras	23	Pinzas nasales	77, 78
<b>OVERHOLT-MIXTER</b> , pinzas para preparaciones y ligaduras	29	Pinzas para agrafes	224, 225
		Pinzas para anastomosis	528, 529, 532, 533
<b>P</b>		Pinzas para aurícula	29
<b>PALMER</b> , clavos	496	Pinzas para bolsas	98
<b>PARAMETRIUM</b> , pinzas-clamps para parametrium	46	Pinzas para cartilago y menisco	453
<b>PARAMETRIUM</b> , tijeras tungsteno TUC	154	Pinzas para catéteres	360
<b>PARKER</b> , separadores	278	Pinzas para coger	12, 13, 66-68, 70, 316
<b>PARKER-LANGENBECK</b> , separadores	278	Pinzas para coger intestinos	9, 517-519
<b>PARTSCH</b> , cinceles	418	Pinzas para coger tejidos	9
<b>PARTSCH</b> , martillos	430	Pinzas para coger tejidos y intestinos	517, 518
<b>PATON</b> , micro-porta-agujas	212	Pinzas para compresas	51, 52
<b>PAUFIQUE</b> , pinzas para sutura	86	Pinzas para compresas y tamponamientos	78
<b>PAYR</b> , pinzas-clamps intestinales y estomacales	530	Pinzas para curaciones	95-97
<b>PAYR</b> , sondas conductoras	221	Pinzas para espinas	73-75
<b>PAYR-BABY</b> , pinzas-clamps intestinales y estomacales	530	Pinzas para esponjas	228-239
<b>PAYR-SCHMIEDEN</b> , sondas conductoras	221	Pinzas para esterilización	564
<b>PEAN</b> , pinzas para coger	13	Pinzas para hilos	401-403, 405, 406
<b>PEAN-DELICATE</b> , pinzas hemostáticas	22	Pinzas para huesos	452, 454-462
<b>PEAN-ROCHESTER</b> , pinzas hemostáticas	18, 19	Pinzas para iris	79-82
		Pinzas para la cámara anterior	85
		Pinzas para papel de articular	98
		Pinzas para pólipos	229-239



	Página		Página
Pinzas para poner	11	<b>RAGNELL-DAVIS</b> , separadores finas	250
Pinzas para preparaciones y ligaduras	23-25, 29, 31-36	<b>RALK</b> , perforadores de mano	389
Pinzas para quitar yeso	320	<b>RALK</b> , pinzas para espinas	75
Pinzas para romper hojas	177	<b>RAMPLEY</b> , pinzas para esponjas	238
Pinzas para sutura	85, 86	<b>RANKIN-CRILE</b> , pinzas hemostáticas	17
Pinzas para tapones	229-239	<b>RANKIN-KELLY</b> , pinzas hemostáticas	17
Pinzas para tener cristalino	90	Raspadores	442-446
Pinzas para torcer hilos tungsteno TUC	203	Rectoscopios	544-550
Pinzas para tubos	53	<b>REHN</b> , cuchillos para transplatación	175
Pinzas para unas	568-570	<b>REILL</b> , micro-porta-agujas	207
Pinzas porta-laminillas	78	<b>REINER</b> , cuchillos para vendajes enyesados	318
Pinzas saca-bocados para biopsia rectal	551	<b>RESANO</b> , pinzas-clamps estomacales y intestinales	527
Pinzas, micro	71, 72	Retractor para amputación	463
Pinzas-clamps bronquiales	30	<b>REVERDIN</b> , agujas	214
Pinzas-clamps de presión progresiva	47, 48	<b>REVERDIN</b> , espátulas abdominales	308
Pinzas-clamps estomacales	531	<b>REYNOLDS</b> , tijeras para preparaciones	112
Pinzas-clamps estomacales y intestinales	520-523	<b>REZAK-HEANEY</b> , pinzas-clamps para histerectomía	44
Pinzas-clamps estomacales y intestinales Atrauma	524-527	<b>RIBBON</b> , tijeras oculares	127
Pinzas-clamps intestinales y estomacales	520-523	<b>RICARD</b> , separadores abdominales	306
Pinzas-clamps intestinales y para anastomosis	532, 533	<b>RICHARDSON (KELLY)</b> , separadores	264
Pinzas-clamps para conducto biliar	37, 40	<b>RICHARDSON-EASTMAN</b> , separadores	264
Pinzas-clamps para parametrium	46	<b>RICHTER</b> , tijeras para cirugía	104
Pinzas-clamps para pedúnculos renales	37-39	<b>RICHTER-HEATH</b> , pinzas para agrafes	224
Pinzas-clamps para peritoneo	49, 50	<b>RIGHBY</b> , separadores autoestáticos	295
Pinzas-gubias	468-476	<b>RIRAP</b> , estetoscopios	378
Pistola lavatoria	590, 591	<b>RISCOPE S</b> , oftalmoscop	381
<b>PLESTER</b> , separadores autoestáticos	295	<b>RISCOPE S</b> , oto-oftalmoscop	380
<b>PLESTER</b> , tubos de aspiración	335	<b>ROBERTS</b> , pinzas hemostáticas	30
<b>POOLE</b> , tubos de aspiración	332	<b>ROBIN-MASSE</b> , separadores abdominales	306
<b>POOLE-BABY</b> , tubos de aspiración	332	<b>ROCHESTER-CARMALT</b> , pinzas hemostáticas	27
Porta-agujas	180-213	<b>ROCHESTER-PEAN</b> , pinzas hemostáticas	18, 19
Porta-agujas micro	204-213	<b>ROEDER</b> , pinzas de campo	52
Porta-agujas tungsteno TUC	192-205	<b>ROEDER</b> , pinzas para compresas	52
Porta-algodones	311, 312	<b>ROETTGEN-RUSKIN</b> , pinzas-gubias	473
Porta-ligaduras	223	<b>ROGGE</b> , pinzas para esterilización	564
<b>POTTS-DE MARTEL</b> , tijeras para cirugía vasculares	116	<b>ROLLET</b> , ganchos	246
<b>POTTS-SMITH</b> , micro-porta-agujas	212	<b>ROSCHKE</b> , anoscopios	537
<b>POTTS-SMITH</b> , micro-porta-agujas tungsteno TUC	205	<b>ROSSEGGER-KLIMA</b> , agujas para biopsia	343
<b>POTTS-SMITH</b> , pinzas de disección	63	<b>ROTTER</b> , agujas para ligaduras	219
<b>POTTS-SMITH</b> , pinzas de disección con dientes	63	<b>ROUX</b> , separadores	277
<b>POTTS-SMITH</b> , pinzas de disección tungsteno TUC	92	<b>ROWE</b> , pinzas de reposición	487
<b>POTTS-SMITH</b> , tijeras	118	<b>RUDD</b> , ligadores hemorroides	554
<b>POTTS-SMITH</b> , tijeras para cirugía vasculares	113, 115	<b>RUMEL</b> , pinzas para preparaciones y ligaduras	30
<b>POTTS-SMITH</b> , tijeras tungsteno TUC	157	<b>RUSKIN</b> , pinzas-gubias	471, 475
<b>PRATT</b> , espéculos rectales	536	<b>RUSKIN-LISTON</b> , pinzas cortantes para huesos	478
<b>PRATT</b> , pinzas hemorroidales	47	<b>RUSKIN-MINI</b> , pinzas-gubias	471
<b>PRATT</b> , sondas	311	<b>RUSS-MAYO</b> , pinzas para coger	66
<b>PRECISA</b> , manómetro para la presión de la sangre	379	<b>RUSS-MODELL</b> , pinzas para coger	68
<b>PRESBYTERIAN</b> , pinzas para tubos	53	<b>RYDER/FRENCH-EYE</b> , porta-agujas tungsteno TUC	193
<b>PRINCE</b> , pinzas musculares	87	<b>RYDER-LANGENBECK</b> , porta-agujas tungsteno TUC	202
<b>PRINCE</b> , tijeras para amígdalas	119	<b>RYDER-MATHIEU VASCULAR</b> , porta-agujas tungsteno TUC	200
Proctoscopios	537-543	<b>RYDER-MATHIEU</b> , porta-agujas tungsteno TUC	200
<b>PROVIDENCE-HOSPITAL</b> , pinzas hemostáticas	16	<b>RYDER-MICRO</b> , porta-agujas tungsteno TUC	193
Punción/Agujas especiales	327-349		
Punzón	451	<b>S</b>	
<b>PUTTI</b> , escofinas	451	<b>SALAH</b> , agujas para biopsia	343
<b>PYE-SMITH (HARRISON)</b> , pinzas para esterilización	564	<b>SALENIUS</b> , bisturios para meniscos	467
<b>PYNCHON-ANDREWS</b> , tubos de aspiración	331	<b>SAMII</b> , pinzas para coger	70
<b>Q</b>		<b>SANVENERO</b> , tijeras para preparaciones	112
<b>QUINBY</b> , tijeras para encías	137	<b>SAROT</b> , pinzas-clamps bronquiales	30
<b>QUINKE</b> , agujas para biopsia	344	<b>SAROT</b> , porta-agujas	183
<b>R</b>		<b>SAROT</b> , porta-agujas tungsteno TUC	197
<b>RABINER</b> , martillos de percusión	369	<b>SATINSKY</b> , tijeras para cirugía vasculares	117
<b>RADOLF</b> , pinza para unas	482	<b>SATTERLEE</b> , sierras para amputación	384
<b>RAGNELL (KILNER)</b> , tijeras para preparaciones	112	<b>SATTLER</b> , pinzas musculares	87
		<b>SAUERBRUCH</b> , pinzas-gubias	474
		<b>SAUERBRUCH</b> , separadores	260, 274
		<b>SAWTELL-SCHNIDT</b> , pinzas hemostáticas para amígdalas	27

<b>SAWYER</b> , espéculos rectales	534	<b>SINGLEY-TUTTLE</b> , pinzas para coger	66
<b>SCALP-CONTOUR</b> , separadores autoestáticos	294	<b>SINUSCOPY</b> , trocares	327
<b>SCHAEDEL</b> , pinzas de campo	51	<b>SMILLIE</b> , bisturíes para meniscos	467
<b>SCHAEDEL</b> , pinzas para compresas	51	<b>SMILLIE</b> , separadores para rodilla	466
<b>SCHANZ</b> , agujas	503	<b>SMITH (MOD. USA)</b> , tijeras para vendajes	133
<b>SCHUDE</b> , cucharillas cortantes	435	<b>SMITH</b> , cizallas para cortar alambre	130
<b>SCHINDLER</b> , pinzas-clamps para peritoneo	50	<b>SMITH-BUIE</b> , espéculos rectales	536
<b>SCHINK</b> , dermatomo	176	<b>SMITH-FERRIS</b> , pinzas de disección con dientes	65
<b>SCHMID</b> , agujas especiales	345	<b>SMITH-HEYWOOD</b> , pinzas para esponjas	236
<b>SCHMIEDEN</b> , agujas para ligaduras	217	<b>SMITH-PETERSEN</b> , cinceles	419
<b>SCHMIEDEN-PAYR</b> , sondas conductoras	221	<b>SMITH-PETERSEN</b> , gubias	419
<b>SCHMIEDEN-TAYLOR</b> , tijeras para cirugía vasculares	116	<b>SMITH-PETERSON</b> , pinzas-gubias	475
<b>SCHNIDT-SAWTELL</b> , pinzas hemostáticas para amígdalas	27	<b>SMITH-POTTS</b> , micro-porta-agujas	212
<b>SCHOEMAKER</b> , tijeras para bocio	119	<b>SMITH-POTTS</b> , micro-porta-agujas tungsteno TUC	205
<b>SCHOEMAKER-LOTH</b> , tijeras para ligaduras	128	<b>SMITH-POTTS</b> , pinzas de disección tungsteno TUC	92
<b>SCHUHNECHT</b> , separadores autoestáticos	289	<b>SMITH-POTTS</b> , tijeras para cirugía vasculares	113, 115
<b>SCHUKNECHT</b> , cizallas para cortar alambre	130	<b>SMITH-POTTS</b> , tijeras tungsteno TUC	157
<b>SCHULZE-BERGMANN</b> , espéculos rectales	535	<b>SNELLEN</b> , pinzas de entropión	88
<b>SCHUMACHER</b> , tijeras umbilicales	121	<b>SNITMAN</b> , separadores autoestáticos	284
<b>SCHWECKENDICK-GOOD</b> , tijeras para amígdalas	119	Sondas	310, 311
<b>SCUDDER</b> , pinzas-clamps estomacales y intestinales	523, 526	Sondas conductoras	220-222
<b>SCUDDER</b> , pinzas-clamps estomacales y intestinales Atrauma	526	Sondas para várices	312
<b>SEBILEAU</b> , elevadores	447	<b>SPENCER</b> , tijeras para ligaduras	128
<b>SEDILLOT</b> , raspadores	445	<b>SPENCER-DELICATE</b> , tijeras para ligaduras	128
<b>SEGOND</b> , pinzas-clamps para histerectomía	45	<b>SPENCER-WELLS</b> , pinzas hemostáticas	14
<b>SEGOND-LANDAU</b> , pinzas-clamps para histerectomía	45	<b>SPRATT</b> , cucharillas cortantes	435
<b>SELLORS-CRAFOORD</b> , pinzas para aurícula	29	<b>ST. MARKS</b> , separadores	275
<b>SEMB</b> , pinzas cortantes para huesos	480	<b>ST. MARTIN</b> , pinzas para sutura	85
<b>SEMB</b> , pinzas para huesos	456	<b>STACKE</b> , sondas	310
<b>SEMB</b> , pinzas-gubias	472	<b>STADLER-BRAUN</b> , tijeras para episiotomía	121
<b>SEMB</b> , raspadores	446	<b>STANDARD</b> , pinzas de disección	57
<b>SEMKEN</b> , pinzas de disección	60	<b>STANDARD</b> , pinzas de disección con dientes	57
<b>SEMKEN</b> , pinzas de disección con dientes	61	<b>STANDARD</b> , tijeras para cirugía	102
<b>SEMKEN</b> , pinzas de disección tungsteno TUC	92	<b>STANDARD</b> , tijeras para encías	137
<b>SEMM</b> , separadores abdominales	303	<b>STANDARD</b> , tijeras tungsteno TUC	152, 153
<b>SENN-GREEN</b> , ganchos	247	<b>STANDARD</b> , trocares	327
<b>SENNING (SCHWED. MODELL)</b> , porta-agujas	183	<b>STEINBACH</b> , martillos	432
<b>SENNING (SCHWED. MODELL)</b> , porta-agujas tungsteno TUC	194	<b>STEINMANN</b> , clavos	399, 497, 498
<b>SENN-MILLER</b> , separadores finas	250	<b>STEINMANN</b> , instrumentos para coger tendones	464
<b>SENN-MILLER-BABY</b> , separadores finas	250	<b>STELLBRINK</b> , pinzas-gubias	468
Separadores	242-308	<b>STERNUM</b> , pinzas para torcer hilos tungsteno TUC	203
Separadores abdominales	298-307	<b>STERNUM</b> , pinzas TUC para hilos	403
Separadores autoestáticos	283, 284, 287-297	<b>STEVENS</b> , micro-porta-agujas	212
Separadores con iluminación de luz fría	281	<b>STEVENS</b> , pinzas para iris	80
Separadores espinales	250	<b>STEVENS</b> , tijeras para tenotomía	126
Separadores finas	250	<b>STEVENS</b> , tijeras tungsteno TUC	161
Separadores óptico por endoscopio	281, 282	<b>STIEGLITZ</b> , pinzas para espinas	75
Separadores para dedos	283	<b>STILLE</b> , cinceles	421
Separadores para el ramo	257	<b>STILLE</b> , cizallas para escayola	320
Separadores para escayola	319	<b>STILLE</b> , gubias	421
Separadores para la cirugía de la mano	285	<b>STILLE</b> , perforadores de mano	386
Separadores para partes blandas	255, 256	<b>STILLE</b> , pinzas de disección	65
Separadores para rodilla	466	<b>STILLE</b> , pinzas de disección con dientes	65
Separadores para tendones	465	<b>STILLE</b> , pinzas-clamps para pedúnculos renales	38
<b>SEUTIN</b> , tijeras para vendajes	134	<b>STILLE</b> , pinzas-gubias	472
<b>SHORTBENT</b> , tijeras para ligaduras	129	<b>STILLE-BARRAYA</b> , pinzas de disección con dientes	65
<b>SIEBOLD</b> , tijeras para ginecología	107	<b>STILLE-DOYEN</b> , separadores	266
Sierra para autopsia	483-485	<b>STILLE-LISTON</b> , pinzas cortantes para huesos	479
Sierras	384, 482-485	<b>STILLE-LUER</b> , pinzas-gubias	473
Sierras para abrir anillos	482	<b>STILLE-MAYO</b> , tijeras	105
Sierras para amputación y resección	384	<b>STILLE-MAYO</b> , tijeras tungsteno TUC	154
Sierras para vendajes enyesados	318	<b>STILLE-RUSKIN</b> , pinzas-gubias	472
Silletas	563	<b>STILLE-SHERMAN</b> , perforadores de mano	385
<b>SIMON</b> , bisturíes para fistulas	174	<b>STRATTE</b> , porta-agujas	185
<b>SIMON</b> , separadores	262	<b>STRATTE</b> , porta-agujas tungsteno TUC	197
<b>SIMS</b> , espéculos rectales	534	<b>STRAUSS</b> , rectoscopios	548
<b>SIMS</b> , tijeras para ginecología	107	<b>STRULLY</b> , tijeras para cirugía vasculares	115
<b>SIMS</b> , tijeras tungsteno TUC	155	<b>SULLIVAN (BROPHY)</b> , tijeras finas	123
<b>SIMS-MAIER</b> , pinzas para pólipos	239	<b>SULLIVAN</b> , tijeras para encías	137



	Página		Página
Super Cut Tijeras SC	101	<b>TOHOKU-JAPAN</b> , pinzas de compresas	52
Sutura	180-225	Tornillos para huesos	505-512
<b>SYME</b> , agujas para ligaduras	216	<b>TOWNLEY</b> , calibrador	372
<b>T</b>		<b>TRAVERS</b> , separadores autoestáticos	288
Tarros	562	Trefina para vendajes enyesados	318
<b>TAYLOR</b> , elevadores para huesos	398	<b>TRELAT</b> , agujas para ligaduras	218
<b>TAYLOR</b> , martillos de percusión	369	<b>TROCAR</b> , agujas para biopsia	344
<b>TAYLOR</b> , pinzas de disección	61	Trocates	327-330
<b>TAYLOR</b> , pinzas de disección con dientes	61	<b>TROELTSCH (WILDE)</b> , pinzas auriculares	77
<b>TAYLOR</b> , separadores espinales	250	<b>TROEMNER</b> , martillos de percusión	370
<b>TAYLOR-CUSHING</b> , pinzas de disección tungsteno TUC	93	<b>TROUTMAN (CORNEAL)</b> , pinzas para iris	82
<b>TAYLOR-SCHMIEDEN</b> , tijeras para cirugía vasculares	116	<b>TROUTMAN</b> , micro-porta-agujas	207
Tensores tierra-hilos	407	<b>TROUTMAN</b> , pinzas para córnea	141
<b>TERRIER</b> , pinzas hemostáticas	14	<b>TROUTMAN-BARRAQUER</b> , micro-porta-agujas	206
<b>TERSON</b> , pinzas para iris	83	<b>TROUTMAN-CHRIS</b> , pinzas para romper hojas	177
<b>THIERSCH</b> , cuchillos para transplatación	175	<b>TÜBINGER MODELL</b> , separadores	262
<b>THIESS</b> , martillos	430	<b>TÜBINGER MODELL</b> , separadores autoestáticos	296
<b>THOMS-ALLIS</b> , pinzas para coger tejidos y intestinos	518	Tubos de aspiración	503
<b>THOREK</b> , tijeras para preparaciones	111	Tubos de aspiración	331-337
<b>THORPE</b> , calibrador	372	<b>TUDOR-EDWARDS</b> , pinzas cortantes para huesos	479
Tijeras	102-162	Tuerce-hilos	223
Tijeras abdominales	106	<b>TUFFIER</b> , espátulas abdominales	308
Tijeras cuticulares	135	<b>TUFFIER</b> , pinzas para coger	12
Tijeras finas	122-124	<b>TUFFIER</b> , separadores	267
Tijeras micro	143-149	<b>TUOHY</b> , agujas para biopsia	344
Tijeras nasales	119, 120	<b>TURNBULL</b> , pinzas corta-unas	568
Tijeras oculares	125-127, 138-143	<b>TUTTLE-SINGLEY</b> , pinzas para coger	66
Tijeras para amígdalas	119	<b>U</b>	
Tijeras para bocio	119	<b>UCKERMANN</b> , porta-algodones	312
Tijeras para capsulotomía	140	<b>ULRICH</b> , pinzas para huesos	462
Tijeras para cartilago	118	<b>ULRICH</b> , pinzas para pólipos	229
Tijeras para catarata secundaria	139	<b>UNIVERSAL</b> , cizallas para cortar alambre	130
Tijeras para cirugía	102-105, 122	<b>UNIVERSAL</b> , perforadores de mano	389
Tijeras para cirugía vasculares	113-117	<b>UNIVERSAL</b> , pinzas-gubias	468
Tijeras para córnea	141-143	<b>UNIVERSAL</b> , tijeras para vendajes	132
Tijeras para coronaria	115	<b>UNIVERSAL</b> , tijeras tungsteno TUC	162
Tijeras para coronas	130, 131	<b>UNIVERSAL</b> , trocates	327
Tijeras para disección	118	<b>US TYPE-BALFOUR</b> , separadores abdominales	299
Tijeras para encías	136, 137	<b>V</b>	
Tijeras para enterótomos	118	<b>VACUNOPA</b> , vacuum cleaner	324
Tijeras para episiotomía	121	<b>VAN BUREN</b> , pinzas para huesos	452
Tijeras para estrabismos	126	<b>VANNAS MOD. TÜBINGEN</b> , pinzas-tijeras para catarata secundaria	139
Tijeras para Face-lift TUC	161	<b>VANNAS</b> , pinzas-tijeras para catarata secundaria	139
Tijeras para fistulas	106	Vendajes	318-324
Tijeras para ginecología	105-107	<b>VERBRUGGE</b> , pinzas para huesos	459
Tijeras para incisión	104	<b>VERNET-GIL</b> , ganchos	249
Tijeras para iridectomía	138	<b>VERNIER</b> , calibrador	372, 373
Tijeras para ligaduras	128, 129	<b>VERRES</b> , agujas especiales	345
Tijeras para lobectomía	118	<b>VIRCHOW</b> , cuchillos para cerebro	173
Tijeras para nervios	111	<b>VISE</b> , pinzas de ligadura con plataforma	71
Tijeras para neurocirugía	115-117	<b>VOLKMANN</b> , cucharillas cortantes	434, 440
Tijeras para preparaciones	108-112	<b>VOLKMANN</b> , separadores	251, 252
Tijeras para tenotomía	126, 140	<b>W</b>	
Tijeras para unas	135	<b>WACHENFELDT</b> , pinzas para agrafes	224
Tijeras para unas encarnadas	135	<b>WAGNER</b> , tijeras finas	122
Tijeras para vendajes	132-134	<b>WALB</b> , cuchillos para órganos	173
Tijeras para vestidos	132, 133	<b>WALDMANN</b> , tijeras para episiotomía	121
Tijeras Super-Cut SC	101	<b>WALTER</b> , separadores	250
Tijeras tungsteno TUC	152-162	<b>WALTER-CARMALT</b> , pinzas para espinas	73
Tijeras umbilicales	121	<b>WALTON</b> , pinzas para pólipos	239
<b>TOENNIS</b> , pinzas para preparaciones y ligaduras	36	<b>WALTON</b> , separadores autoestáticos	297
<b>TOENNIS</b> , porta-agujas	188	<b>WALTON</b> , sierras para abrir anillos	482
<b>TOENNIS</b> , porta-agujas tungsteno TUC	201	<b>WALTON</b> , tijeras finas	124
<b>TOENNIS</b> , tijeras para cirugía vasculares	116		
<b>TOENNIS-ADSON</b> , tijeras para cirugía vasculares	116		
<b>TOENNIS-ADSON-DELICATE</b> , tijeras tungsteno TUC	161		
<b>TOHOKU-JAPAN</b> , pinzas de campo	52		

<b>WALTON-LISTON</b> , pinzas cortantes para huesos	478
<b>WALTON-YANKAUER</b> , tubos de aspiración	331
<b>WANGENSTEEN</b> , pinzas de disección	65
<b>WANGENSTEEN</b> , pinzas de disección tungsteno TUC	94
<b>WANGENSTEEN</b> , porta-agujas	185
<b>WANGENSTEEN</b> , porta-agujas tungsteno TUC	197
<b>WANGENSTEEN-DELICATE</b> , porta-agujas	185
<b>WARTENBERG</b> , instrumentos sensibilidad	376
<b>WATSON</b> , dermatomo	176
<b>WAUGH</b> , pinzas para coger	67
<b>WEBSTER</b> , porta-agujas	181
<b>WEBSTER</b> , porta-agujas tungsteno TUC	195
<b>WECKER</b> , pinzas-tijeras para iridectomía	138
<b>WEITLANER</b> , separadores autoestáticos	287
<b>WEITLANER-BABY</b> , separadores autoestáticos	287
<b>WELLS-SPENCER</b> , pinzas hemostáticas	14
<b>WERTHEIM</b> , pinzas-clamps para histerectomía	41, 42
<b>WERTHEIM</b> , porta-agujas	185
<b>WERTHEIM</b> , porta-agujas tungsteno TUC	198
<b>WERTHEIM</b> , tijeras	106
<b>WERTHEIM-CULLEN</b> , pinzas-clamps para histerectomía	44
<b>WESTCOTT</b> , micro-tijeras	143
<b>WESTCOTT</b> , pinzas-tijeras para tenotomía	140
<b>WESTERMARK</b> , pinzas para tapones	232
<b>WIGMORE</b> , cuchillas para vendajes enyesados	318
<b>WIKSTROEM</b> , pinzas para preparaciones y ligaduras	41
<b>WILDBERG</b> , grapas	496
<b>WILDE (TROELTSCH)</b> , pinzas auriculares	77
<b>WILLET-MARTEL</b> , pinzas hemostáticas para pericráneo	12
<b>WILLIAMS</b> , pinzas para coger tejidos y intestinos	518
<b>WILLIGER</b> , cucharillas cortantes	440
<b>WILLIGER</b> , elevadores	447
<b>WILLIGER</b> , martillos	428
<b>WILLIGER</b> , raspadores	444
<b>WILMER</b> , tijeras oculares	126
<b>WISCONSIN (FOREGGER)</b> , Fibre Optic laringoscopios	358
<b>WISCONSIN (FOREGGER)</b> , laringoscopios	354
<b>WOLFF</b> , pinzas para quitar yeso	320
<b>WULLSTEIN MICRO</b> , tubos de aspiración	335
<b>WULLSTEIN</b> , separadores autoestáticos	289

## Y

<b>YANCOSKIE</b> , separadores de abdominoplastia	280
<b>YANKAUER</b> , tubos de aspiración	331
<b>YANKAUER-WALTON</b> , tubos de aspiración	331
<b>YEOMAN</b> , pinzas saca-bocado para biopsia rectal	551
<b>YOUNG-HRYNTSCHAK</b> , boomerang porta-agujas	189

## Z

<b>ZAUFAL-JANSEN</b> , pinzas-gubias	471
<b>ZENKER</b> , pinzas para preparaciones y ligaduras	32
<b>ZENKER</b> , separadores	272
<b>ZIEGLER</b> , pinzas depilatorias	76
<b>ZWEIFEL</b> , porta-agujas	187
<b>ZWEIFEL</b> , porta-agujas tungsteno TUC	202



	Page		Page
<b>A</b>			
Accessoires pour broches centro-médullaires	490	<b>BABY/DUPLEX-LIGHTWEIGHT</b> , stéthoscopes	378
Accessoires pour power drills	392	<b>BABY-ADSON</b> , pinces à dissection	25
Accu power drill	391	<b>BABY-BALFOUR</b> , écarteurs abdominaux	299
Accumulateur / chargeur d'accus	393	<b>BABY-COLLIN</b> , écarteurs abdominaux	304
<b>ADAMS-MAYO</b> , écarteurs autostatiques	296	<b>BABY-CRILE-WOOD</b> , porte-aiguilles	182
<b>ADISON</b> , pince-guide pour perforateurs	390	<b>BABY-CRILE-WOOD</b> , porte-aiguilles tungstène TUC	196
<b>ADLERKREUTZ</b> , pinces à griffes	65	<b>BABY-DOYEN</b> , pinces-clamps stomacales et pour l'intestin	520
<b>ADSON</b> , canules d'aspiration	335	<b>BABY-KOCHER</b> , pinces-clamps stomacales et pour l'intestin	521, 526
<b>ADSON</b> , écarteurs autostatiques	290, 291	<b>BABY-LEXER</b> , ciseaux à dissection	111
<b>ADSON</b> , élévateurs	449	<b>BABY-METZENBAUM</b> , ciseaux à dissection	108
<b>ADSON</b> , pinces à dissection et à griffes	59, 60	<b>BABY-MIKULICZ</b> , pinces-clamps pour le péritoine	49
<b>ADSON</b> , pinces à dissection et à ligatures	25	<b>BABY-MIXTER</b> , pinces à dissection et à ligatures	33
<b>ADSON</b> , pinces à dissection tungstène TUC	93	<b>BABY-OVERHOLT</b> , pinces à dissection et à ligatures	23
<b>ADSON</b> , porte-aiguilles	183	<b>BABY-POOLE</b> , canules d'aspiration	332
<b>ADSON-ANDERSON</b> , écarteurs autostatiques	290	<b>BABY-SENN-MILLER</b> , écarteurs fins	250
<b>ADSON-BABY</b> , écarteurs autostatiques	292	<b>BABY-WEITLANER</b> , écarteurs autostatiques	287
<b>ADSON-BABY</b> , pinces à dissection et à ligatures	25	<b>BACKHAUS</b> , pinces à champs	52
<b>ADSON-BECKMANN</b> , écarteurs autostatiques	293	<b>BACON</b> , pinces-gouges	470
<b>ADSON-BROWN</b> , pinces à griffes	60	<b>BAINBRIDGE</b> , pinces hémostatiques	27
<b>ADSON-MICRO</b> , pinces à dissection et à griffes	59	<b>BAINBRIDGE</b> , pinces-clamps stomacales et pour l'intestin Atrauma	524
<b>ADSON-TOENNIS</b> , ciseaux vasculaires	116	<b>BALFOUR US-TYPE</b> , écarteurs abdominaux	299
<b>ADVENTITIA</b> , micro-ciseaux	145, 147	<b>BALFOUR</b> , écarteurs abdominaux	299, 300
Agrafes	225	<b>BALFOUR-BABY</b> , écarteurs abdominaux	299
Agrafes	496	<b>BALL &amp; SOCKET</b> , pinces à champs	52
Aiguilles à ligatures	215-219	<b>BALLANTINE-HEANEY</b> , pinces à hystérectomie	43
Aiguilles de Reverdin	214	<b>BALLENGER-FOERSTER</b> , pinces à éponges	237
Aiguilles d'introduction	346	<b>BARRAQUER</b> , ciseaux à iridectomie	138
Aiguilles pour biopsie	343, 344	<b>BARRAQUER</b> , micro-porte-aiguilles	206
Aiguilles spéciales	345	<b>BARRAQUER</b> , pinces à épiler les cils	76
Air power drill	391	<b>BARRAQUER</b> , pinces pour la chambre antérieure	85
<b>ALAN PARKS</b> , anuscopes	537	<b>BARRAQUER-KATZIN (COLIBRI)</b> , pinces à iris	82
<b>ALDERDYCE</b> , élévateurs	448	<b>BARRAQUER-KATZIN</b> , ciseaux cornéales	142
Alésioir pour vis d'ostéo-synthèse	513	<b>BARRAQUER-TROUTMAN</b> , micro-porte-aiguilles	206
<b>ALEXANDER</b> , ciseaux-burins	418	<b>BARRAYA-STILLE</b> , pinces à griffes	65
<b>ALEXANDER</b> , rugines-raspatoires	446	Bassins réniformes	559
<b>ALLIS</b> , pinces pour saisir le tissu	9	<b>BAUMGARTNER</b> , porte-aiguilles	184
<b>ALLIS</b> , pinces pour saisir le tissu et l'intestin	517	<b>BECK-LUETHY</b> , porte-aiguilles tungstène TUC	202
<b>ALLIS-ADAIR</b> , pinces pour saisir le tissu et l'intestin	517	<b>BECKMANN</b> , écarteurs autostatiques	292
<b>ALLIS-BABY</b> , pinces pour saisir le tissu et l'intestin	517	<b>BECKMANN-ADSON</b> , écarteurs autostatiques	293
<b>ALM</b> , écarteurs autostatiques	283	<b>BECKMANN-EATON</b> , écarteurs autostatiques	293
<b>ALY</b> , instruments sensibilités	376	<b>BEEBEE</b> , ciseaux à couronnes	130, 131
<b>ANDERSON-ADSON</b> , écarteurs autostatiques	290	<b>BEER</b> , pinces à épiler les cils	76
<b>ANDREWS-PYNCHON</b> , canules d'aspiration	331	<b>BEESON</b> , pinces écartante pour appareils plâtrés	319
Anesthésie	353-363	<b>BENGOLEA</b> , pinces hémostatiques	28
Anuscopes	537-543	<b>BENSAUDE</b> , anuscopes	540
<b>ANVIL</b> , pinces à ongles	571	<b>BERENS</b> , pinces musculaires	88
<b>ARLT-FISCHER</b> , pinces à iris	80	<b>BERGMANN</b> , ciseaux pour pansements	132
<b>ARRUGA</b> , micro-porte-aiguilles	212	<b>BERGMANN</b> , marteaux	427
<b>ARRUGA</b> , pinces capsulaires	83	<b>BERGMANN</b> , scie pour appareils plâtrés	318
<b>ARRUGA</b> , porte-aiguilles	180	<b>BERKE</b> , pinces à chalazion	89
<b>ARRUGA</b> , porte-aiguilles tungstène TUC	201	<b>BERLINER</b> , marteaux-percuteurs	370
<b>ARRUGA-KALT</b> , micro-porte-aiguilles	212	<b>BERNHARD</b> , pinces à champs	51
Arthroscopie	408-415	<b>BEYER</b> , pinces-gouges	471
<b>AUSTIN</b> , pinces à ligatures avec plate-forme	71	<b>BILLROTH</b> , écarteurs	252
<b>AUSTRALIA</b> , écarteurs	283	<b>BINKHORST</b> , pinces capsulaires	83
<b>AUSTRALIA</b> , écarteurs de la chirurgie de la main	285	<b>BIRCHER</b> , bistouris à ménisques	467
<b>AYER</b> , pinces à chalazion	88	<b>BIRCHER-GANSKE</b> , daviers à ménisques	453
<b>B</b>			
<b>BABCOCK</b> , pinces pour saisir l'intestin	9, 519	<b>BIRKETT</b> , pinces à dissection et à ligatures	41
<b>BABINSKY</b> , marteaux-percuteurs	369	<b>BISHOP-HARMAN</b> , pinces à iris	82
<b>BABY KOCHER</b> , pinces-clamps stomacales et pour l'intestin Atrauma	526	Bistouris	165-177
		Bistouris à abcès	174
		Bistouris à fistules	174
		Bistouris à ménisques	467
		Bistouris pour opérations	169-171
		<b>BLASCOVICS</b> , pinces musculaires	87



	Page		Page
<b>BLOND</b> , anuscopes	542, 543	<b>CARMALT-WALTER</b> , pinces à échardes	73
<b>BLOUNT</b> , écarteurs pour le genou	466	<b>CAROLL</b> , goniomètres	373
<b>BLOUNT</b> , leviers à os	398	<b>CAROLL</b> , instruments pour saisir les tendons	464
<b>BLUEPOWER</b> , scie électrique pour appareils plâtrés	322	<b>CARREL</b> , pinces hémostatiques	14
<b>BLUMENTHAL</b> , pinces-gouges	469	<b>CARROLL</b> , porte-aiguilles	182
<b>BÖHLER</b> , étriers à extension	399	<b>CARROLL</b> , porte-aiguilles tungstène TUC	194
<b>BÖHLER</b> , pinces-gouges	471	<b>CARTILAGE-MARTIN</b> , ciseaux	118
Boîtes	559, 561, 562	<b>CASTROVIEJO</b> , cercle	375
Boîtes pour instruments	562	<b>CASTROVIEJO</b> , ciseaux à iridectomie	138
Boîtes pour stériliser des aiguilles	560	<b>CASTROVIEJO</b> , ciseaux cornéales	141
<b>BOLEY</b> , calibres	373	<b>CASTROVIEJO</b> , micro-porte-aiguilles	210, 213
<b>BONACCOLTO</b> , pinces pour sutures	85	<b>CASTROVIEJO</b> , micro-porte-aiguilles tungstène TUC	204, 205
<b>BONNEY</b> , pinces à dissection tungstène TUC	94	<b>CASTROVIEJO</b> , pinces à fixer	84
<b>BONNEY</b> , pinces à griffes et pour saisir les tissus	68	<b>CASTROVIEJO</b> , pinces capsulaires	83
Boomerang porte-aiguilles	189	<b>CASTROVIEJO</b> , pinces pour sutures	85
<b>BÖTTCHER</b> , ciseaux pour les amygdales	119	<b>CASTROVIEJO</b> , pincettes pour casser les lames	177
<b>BOYNTON</b> , porte-aiguilles	180	<b>CASTROVIEJO-EPKER</b> , cercle	375
<b>BOYNTON</b> , porte-aiguilles tungstène TUC	201	<b>CASTROVIEJO-KALT</b> , micro-porte-aiguilles	212
<b>BOYS-ALLIS</b> , pinces pour saisir le tissu et l'intestin	518	<b>CATLIN</b> , couteaux à amputation	172
<b>BOZEMANN</b> , instruments pour la suture	223	<b>CHADWICK</b> , ciseaux oculaires	126
<b>BOZEMANN</b> , pinces à tampons	233	<b>CHAPUT</b> , pinces à saisir	12
<b>BOZEMANN</b> , porte-aiguilles	182	<b>CHARRIERE</b> , scies à amputation	384
<b>BOZEMANN</b> , porte-aiguilles tungstène TUC	197	<b>CHEATLE</b> , pinces à stérilisation	564
<b>BOZEMANN-DOUGLAS</b> , pinces à tampons	233	<b>CHERON</b> , pinces à tampons	234
<b>BRAND</b> , instruments pour saisir les tendons	464	<b>CHILDE</b> , pinces pour agrafes	225
<b>BRAUN-STADLER</b> , ciseaux à épisiotomie	121	<b>CHRIS-TROUTMAN</b> , pincettes pour casser les lames	177
<b>BRIDGE</b> , pinces à dissection et à ligatures	34	<b>CHURCH</b> , ciseaux vasculaires	117
Broches	499-502	Cisailles pour appareils plâtrés	134
Broches à crochet	495	Cisailles pour fils	130
<b>BRODIE</b> , sondes	311	Ciseaux	102-162
<b>BROPHY (SULLIVAN)</b> , ciseaux fins	123	Ciseaux à chirurgie	102-105, 122
<b>BROPHY</b> , pinces à dissection et à griffes	63	Ciseaux à couronnes	130, 131
Brosses pour nettoyer	583-589	Ciseaux à dissection	108-112
<b>BROWN</b> , pinces à griffes	64	Ciseaux à envies	135
<b>BROWN</b> , porte-aiguilles	183	Ciseaux à épisiotomie	118, 121
<b>BROWN-ADSON</b> , pinces à griffes	60	Ciseaux à gencives	136, 137
<b>BROWNE-DENIS</b> , écarteurs abdominaux	301	Ciseaux à goitre	119
Brucelles pour coton	95-97	Ciseaux à gynécologie	105-107
<b>BRUNNER</b> , aiguilles à ligatures	216, 217	Ciseaux à incision	104
<b>BRUNNER</b> , écarteurs	263	Ciseaux à iridectomie	125, 138
<b>BRUNNER</b> , pinces-clamps stomacales et pour l'intestin	520	Ciseaux à ligatures	128, 129
<b>BRUNNER</b> , sondes conductrices	220	Ciseaux à lobectomie	118
<b>BRUNNER-FERROZELL</b> , sondes conductrices	222	Ciseaux à ongles	135
<b>BRUNS</b> , cisailles pour appareils plâtrés	134	Ciseaux à préparation	108-112, 118
<b>BRUNS</b> , curettes tranchantes	434, 437	Ciseaux à strabisme	126
<b>BRYANT</b> , pinces à éponges	228	Ciseaux à ténotomie	126, 140
<b>BUCK</b> , ciseaux à ligatures	129	Ciseaux abdominaux	106
<b>BUCK</b> , marteaux-percuteurs	369	Ciseaux cornéales	141-143
<b>BUELAU</b> , trocars	328	Ciseaux coronaires	115
Bulldog clamps	10, 11	Ciseaux fins	122-124
<b>BUNNELL</b> , instruments à écorcher les tendons	465	Ciseaux micro	143-149
<b>BUNNELL</b> , perforateurs à main	388	Ciseaux nasaux	119, 120
<b>BUSCH</b> , ciseaux pour le cordon ombilical	121	Ciseaux oculaires	125-127, 138-143
<b>BYRD</b> , canules d'aspiration	332	Ciseaux pour capsulotomie	140
		Ciseaux pour chirurgie vasculaire	113-117
<b>C</b>		Ciseaux pour Face-lift	161
<b>CAIRNS</b> , pinces hémostatiques	22	Ciseaux pour fistules	106
Calibres	372, 373	Ciseaux pour le cartilage	118
<b>CAMPBELL</b> , trocars	328	Ciseaux pour le cataracte secondaire	139
<b>CANNY RYALL</b> , écarteurs	279	Ciseaux pour le cordon ombilical	121
Canules d'aspiration	503	Ciseaux pour les amygdales	119
Canules d'aspiration	331-337	Ciseaux pour nerfs	111
Canules de liposuccion et infiltration	339, 341, 342	Ciseaux pour neurochirurgie	115-117
<b>CAPLAN</b> , ciseaux nasaux	119	Ciseaux pour ongles incarnés	135
<b>CARDINALE</b> , ciseaux à gynécologie	107	Ciseaux pour pansements	132-134
<b>CARDINALE</b> , ciseaux à gynécologie tungstène TUC	155	Ciseaux super cut SC	101
<b>CARDIOPHON</b> , stéthoscopes	378	Ciseaux tungstène TUC	152-162
<b>CARMALT-ROCHESTER</b> , pinces hémostatiques	27	Ciseaux-burins	417-426
		Clamps bulldog	10, 11

	Page		Page
<b>CLAR 55</b> , éclairateurs frontaux	368	Curettes tranchantes	434-441
<b>CLAR STANDARD</b> , éclairateurs frontaux	368	<b>CUSHING</b> , crochets très fins	244, 248
<b>CLASSON</b> , ciseaux vasculaires	117	<b>CUSHING</b> , écarteurs spinals	250
<b>CLAUS</b> , aiguilles à ligatures	218	<b>CUSHING</b> , perforateurs à main	387
<b>CLAUS-EICKEN</b> , aiguilles à ligatures	219	<b>CUSHING</b> , pinces à dissection et à griffes	62
<b>CLEVELAND</b> , pinces coupantes à os	478	<b>CUSHING</b> , pinces à dissection tungstène TUC	93
<b>CLEVELAND</b> , pinces-gouges	468	<b>CUSHING-TAYLOR</b> , pinces à dissection tungstène TUC	93
<b>CLEVELAND-GARDNER</b> , pinces coupantes à os	477	Cuvettes	559, 562
Clips de stérilisation	564	<b>CZERNY</b> , écarteurs	279
Clous	492-498	<b>CZERNY</b> , spéculums rectaux	534
Clous à os	496		
<b>CLOWARD HIBBS SPRATT</b> , curettes tranchantes	437	<b>D</b>	
<b>COAKLEY</b> , trocars	330		
<b>COBB</b> , ciseaux-burins	424	<b>DAHMEN</b> , ciseaux-burins	425
<b>COBB</b> , curettes tranchantes	439	<b>DAHMEN</b> , ostéotomes	425
<b>COBB</b> , élévateurs	449	<b>DANDY</b> , ciseaux vasculaires	115
<b>COGSWELL</b> , canules d'aspiration	336	<b>DANDY</b> , pinces hémostatiques pour le cuir chevelu	26
<b>COLIBRI (BARRAQUER-KATZIN)</b> , pinces à iris	82	<b>DARLING</b> , écarteurs autostatiques	295
<b>COLLEGE LONDON</b> , précelles(Brucelles) pour coton	95	<b>DAVIDSON</b> , écarteurs	276
<b>COLLER</b> , pinces hémostatiques	17	Daviers à cartilage	453
<b>COLLIER</b> , porte-aiguilles	180	Daviers à ménisques	453
<b>COLLIN</b> , bistouris	170	Daviers à ménisques	466
<b>COLLIN</b> , couteaux à amputation	172	Daviers à os	394
<b>COLLIN</b> , dynamomètre	374	Daviers porte-os	452, 454-462
<b>COLLIN</b> , écarteurs abdominaux	304, 305	<b>DAVIS-RAGNELL</b> , écarteurs fins	250
<b>COLLIN</b> , manches pour bistouris	166	<b>DE BAKEY</b> , canules d'aspiration	331
<b>COLLIN</b> , marteaux	429	<b>DE BAKEY</b> , ciseaux tungstène TUC	157
<b>COLLIN</b> , pinces à saisir	13	<b>DE BAKEY</b> , ciseaux vasculaires	113, 116
<b>COLLIN</b> , pinces à tampons	234	<b>DE BAKEY</b> , dilataateurs vasculaires	314
<b>COLLIN</b> , pinces pour agrafes	224	<b>DE BAKEY</b> , pinces à dissection tungstène TUC	94
<b>COLLIN-BABY</b> , écarteurs abdominaux	304	<b>DE BAKEY</b> , pinces atrauma	91
<b>COLLIN-DUVAL</b> , pinces pour saisir les tissus	66	<b>DE BAKEY</b> , porte-aiguilles tungstène TUC	192
<b>COLLIN-HARTMANN</b> , écarteurs	277	<b>DE LA ROZA</b> , aiguilles à ligatures	217
<b>CONE</b> , écarteurs autostatiques	292	<b>DE MARTEL-POTTS</b> , ciseaux vasculaires	116
<b>CONVERSE</b> , porte-aiguilles tungstène TUC	195	<b>DE MARTEL-WOLFSON</b> , pinces-clamps à anastomose	532, 533
<b>CONVERSE-DERF</b> , porte-aiguilles	180	<b>DE MARTEL-WOLFSON</b> , pinces-clamps intestinales	532, 533
<b>COOLEY</b> , canules d'aspiration	333	<b>DEAN</b> , ciseaux à gencives	136
<b>COOLEY</b> , dilataateurs vasculaires	313	<b>DEAN</b> , ciseaux tungstène TUC	162
<b>COOPER</b> , aiguilles à ligatures	216	<b>DEAN-DELICATE</b> , ciseaux à gencives	136
<b>CORNEAL (TROUTMAN)</b> , pinces à iris	82	<b>DEAVER</b> , ciseaux à chirurgie	104
<b>CORWIN</b> , pinces à fil TUC	403	<b>DEAVER</b> , écarteurs	269-271
<b>CORWIN</b> , pinces à torsader le fil tungstène TUC	203	<b>DEJERINE</b> , marteaux-percuteurs	370
<b>CORYLLOS</b> , écarteurs	274	<b>DELICATE-METZENBAUM</b> , ciseaux tungstène TUC	158-160
<b>COTTLE KAZANJIAN</b> , pinces coupantes à os	477	<b>DELICATE-TOENNIS-ADSON</b> , ciseaux tungstène TUC	161
<b>COTTLE</b> , ciseaux nasaux	120	<b>DEMEL</b> , tendeurs serre-fils	407
<b>COTTLE</b> , marteaux	428	<b>DENIS-BROWNE</b> , écarteurs abdominaux	301
<b>COTTLE</b> , pinces nasales	77	<b>DERF</b> , porte-aiguilles	180
<b>COUPLAND</b> , canules d'aspiration	337	<b>DERF</b> , porte-aiguilles tungstène TUC	195
Couteaux à amputation	172	<b>DERF-CONVERSE</b> , porte-aiguilles	180
Couteaux à autopsie	173	Dermatome	176
Couteaux à cerveaux	173	<b>DESCHAMPS</b> , aiguilles à ligatures	215
Couteaux à transplantation	175	<b>DESJARDINS</b> , pinces-clamps pour voies biliaires	40
Couteaux pour appareils plâtrés	318	<b>DESMARRES</b> , crochets très fins	248
<b>CRAFOORD</b> , ciseaux	118	<b>DESMARRES</b> , pinces à chalazion	88
<b>CRAFOORD</b> , pinces-clamps à bronches	30	Diagnostic	367-382
<b>CRAFOORD-SELLORS</b> , pinces auriculaires	29	<b>DICK</b> , pinces à anastomose	528
<b>CRANE-KAPLAN</b> , pinces pour cul-de-sac	98	<b>DIEFFENBACH</b> , bistouris	170, 171
<b>CREGO</b> , leviers à os	398	<b>DIEFFENBACH</b> , bistouris à abcès	174
<b>CRILE</b> , pinces hémostatiques	17	<b>DIEFFENBACH</b> , clamps bulldog	11
<b>CRILE</b> , porte-aiguilles	187	<b>DIETRICH</b> , micro-porte-aiguilles tungstène TUC	205
<b>CRILE-MURRAY</b> , porte-aiguilles	182	<b>DIETRICH-HEGEMANN</b> , ciseaux vasculaires	114
<b>CRILE-RANKIN</b> , pinces hémostatiques	17	Dilatateurs vasculaires	313, 314
<b>CRILE-WOOD</b> , porte-aiguilles	182	Dilataateurs vasculaires	72, 313, 314
<b>CRILE-WOOD</b> , porte-aiguilles tungstène TUC	196	<b>DINGMANN</b> , daviers à cartilage	453
<b>CRILE-WOOD-BABY</b> , porte-aiguilles	182	<b>DIPLOMAT</b> , tensiomètre à mercure	379
<b>CRILE-WOOD-BABY</b> , porte-aiguilles tungstène TUC	196	<b>DISSECTION</b> , micro-ciseaux	145, 147
Crochets très fins	242-250	<b>DIXON-LOVELACE</b> , pinces hémostatiques	26
<b>CULLEN-WERTHEIM</b> , pinces à hystérectomie	44	<b>DOUGLAS</b> , pinces à épiler les cils	76
Curettes	434-441	<b>DOUGLAS</b> , trocars	330



	Page		Page
<b>DOUGLAS-BOZEMANN</b> , pinces à tampons	233	<b>FARREL</b> , porte-coton	311
<b>DOYEN</b> , ciseaux	106	<b>FAULKNER</b> , pinces à tenir de cristallins	90
<b>DOYEN</b> , écarteurs	267	<b>FAURE</b> , pinces à hystérectomie	45
<b>DOYEN</b> , écarteurs abdominaux	302	<b>FAURE</b> , pinces-clamps pour le péritoine	50
<b>DOYEN</b> , marteaux	428	<b>FAVALORO</b> , ciseaux vasculaires	115
<b>DOYEN</b> , pinces à champs	51	<b>FEHLAND</b> , pinces-clamps stomacales et pour l'intestin	527
<b>DOYEN</b> , pinces-clamps stomacales et pour l'intestin	520, 524	<b>FEILCHENFELD</b> , pinces à échardes	73
<b>DOYEN</b> , pinces-clamps stomacales et pour l'intestin Atrauma	524	<b>FEIN</b> , porte-coton	312
<b>DOYEN</b> , porte-aiguilles	180	<b>FERGUSON</b> , canules d'aspiration	335
<b>DOYEN</b> , rugines-raspatoires	445	<b>FERGUSON</b> , ciseaux à chirurgie	104
<b>DOYEN</b> , sondes	310	<b>FERGUSON</b> , daviers porte-os	455
<b>DOYEN-STILLE</b> , écarteurs	266	<b>FERGUSON</b> , pinces-clamps à pression progressive	47
<b>DUBOIS</b> , ciseaux à gynécologie	107	<b>FERREIRA</b> , écarteurs avec illumination à lumière froide	280
<b>DUEHRSSSEN</b> , pinces à dissection	64	<b>FERRIS-SMITH</b> , pinces à griffes	65
<b>DUNHILL</b> , pinces hémostatiques	22	<b>FERROZELL</b> , sondes conductrices	222
<b>DUPLAY</b> , pinces à pansements	236	<b>FIBRE OPTIC</b> , Fibre Optic laryngoscopes	360
<b>DUPLEX-LIGHTWEIGHT/BABY</b> , stéthoscopes	378	<b>FINOCCHIETTO</b> , ciseaux	118
<b>DURANTE</b> , pinces pour saisir les tissus	68	<b>FINOCCHIETTO</b> , pinces-clamps pour pédicules rénaux	37
<b>DUVAL</b> , pinces pour saisir les tissus	68	<b>FINOCCHIETTO</b> , porte-aiguilles	185
<b>DUVAL</b> , pinces pour saisir l'intestin	519	<b>FINOCCHIETTO</b> , porte-aiguilles tungstène TUC	197
<b>DUVAL-COLLIN</b> , pinces pour saisir les tissus	66	<b>FINSEN</b> , écarteurs autostatiques	283
Dynamomètre	374	<b>FISCHER-ARLT</b> , pinces à iris	80
<b>DYNAMOMETRE III</b> , instruments pour mesurer	374	<b>FLAGG</b> , précelles (brucelles) pour coton	96
<b>E</b>		<b>FLETCHER</b> , pinces à éponges	232
<b>EASTMAN-RICHARDSON</b> , écarteurs	264	<b>FOERSTER</b> , pinces à iris	81
<b>EATON-BECKMANN</b> , écarteurs autostatiques	293	<b>FOERSTER-BALLENGER</b> , pinces à éponges	237
Écarteurs	242-308	<b>FOMON</b> , ciseaux à dissection	111
Écarteurs abdominaux	298-307	<b>FOMON</b> , ciseaux nasaux	119
Écarteurs autostatiques	283, 284, 287-297	<b>FOREGGER (WISCONSIN)</b> , Fibre Optic laryngoscopes	358
Écarteurs avec illumination à lumière froide	281	<b>FOREGGER (WISCONSIN)</b> , laryngoscopes	354
Écarteurs de la chirurgie de la main	285	<b>FOX</b> , curettes tranchantes	436
Écarteurs fins	250	<b>FOX-GOLDMAN (SPECIAL)</b> , ciseaux à gencives	136
Écarteurs optique pour endoscope	281, 282	<b>FOX-GOLDMAN</b> , ciseaux à gencives	136
Écarteurs pour appareils plâtrés	320	<b>FOX-GOLDMAN</b> , ciseaux tungstène TUC	161
Écarteurs pour le genou	466	<b>FRANKENFELDT</b> , pinces pour saisir	316
Écarteurs pour parties molles	255, 256	<b>FRANZ</b> , écarteurs abdominaux	302
Écarteurs pour ramus	257	<b>FRAZIER</b> , canules d'aspiration	335
Écarteurs spinals	250	<b>FRAZIER</b> , crochets très fins	242
<b>ECHLIN</b> , pinces-gouges	474	<b>FREER</b> , élévateurs	448
Éclaireurs frontaux	368	<b>FRENCH-EYE/RYDER</b> , porte-aiguilles tungstène TUC	193
<b>ECONOM</b> , trousse à diagnostic	380	<b>FRIEDMAN</b> , pinces-gouges	468
Ecraseurs et pinces-clamps pour l'intestin et l'estomac	530	<b>FRIEDRICH</b> , instrument pour la suture	223
<b>EICKEN</b> , trocarts	330	<b>FRI TSCH</b> , écarteurs	266
<b>EICKEN-CLAUS</b> , aiguilles à ligatures	219	<b>FRYKHOLM</b> , pinces-gouges	474
<b>EICKEN-KILLIAN</b> , canules d'aspiration	335	<b>FUCHS-GILL</b> , pinces à iris	83
<b>EISELSBERG</b> , ciseaux à ligatures	128	<b>FULTON</b> , ciseaux vasculaires	117
Élévateurs	447-449, 481	<b>G</b>	
<b>ELSCHNIG</b> , pinces à fixer	84	<b>GARRETT</b> , dilateurs vasculaires	313
<b>ENGEL</b> , scie à main pour appareils plâtrés	318	<b>GEISSENDOERFER-OVERHOLT</b> , pinces à dissection et à ligatures	23
<b>ENGL. MODELL</b> , pinces à champs	51	<b>GELPI</b> , écarteurs autostatiques	294
<b>ERHARDT</b> , pinces à entropion	88	<b>GEMINI</b> , pinces à dissection et à ligatures	35
<b>ESMARCH</b> , ciseaux pour pansements	134	<b>GERALD</b> , pinces à dissection et à griffes	62
<b>ESMARCH</b> , couteaux pour appareils plâtrés	318	<b>GERSTER</b> , daviers à os	394
Etriers à extension	399, 400	<b>GERSTER-LOWMAN</b> , daviers à os	394
<b>EUFRATE-PASQUÉ</b> , porte-aiguilles tungstène TUC	193	<b>GILL</b> , pinces capsulaires	83
<b>EWALD</b> , pinces à dissection et à griffes	60	<b>GILL-FUCHS</b> , pinces à iris	83
<b>EXCENTRIC-LISTER</b> , ciseaux pour pansements	133	<b>GILL-HESS</b> , pinces à iris	82
<b>F</b>		<b>GILLIES</b> , crochets très fins	242
<b>FALK</b> , aiguilles à ligatures	219	<b>GILLIES</b> , pinces à dissection tungstène TUC	92
<b>FARABEUF</b> , daviers porte-os	458	<b>GILLIES</b> , pinces à griffes	67
<b>FARABEUF</b> , écarteurs	278	<b>GILLIES</b> , porte-aiguilles	185
<b>FARABEUF</b> , rugines-raspatoires	443	<b>GILLIES</b> , porte-aiguilles tungstène TUC	198
<b>FARABEUF-LAMBOTTE</b> , daviers porte-os	458	<b>GILLS-WELSH</b> , ciseaux pour capsulotomie	140
		<b>GIL-VERNET</b> , écarteurs fins	249
		<b>GOELET</b> , écarteurs	279
		<b>GOLDMAN-FOX (SPECIAL)</b> , ciseaux à gencives	136
		<b>GOLDMAN-FOX</b> , ciseaux à gencives	136

	Page		Page
<b>GOLDMAN-FOX</b> , ciseaux tungstène TUC	161	<b>HOHMANN</b> , leviers à os	396, 397
Goniomètres	373	<b>HOKE</b> , ostéotomes	417
<b>GOOD</b> , ciseaux pour les amygdales	119	<b>HOLINGER</b> , laryngoscopes	362
<b>GOOD-SCHWECKENDICK</b> , ciseaux pour les amygdales	119	<b>HOPKINS</b> , couteaux pour appareils plâtrés	318
<b>GORNEY</b> , ciseaux à dissection	111	<b>HOPKINS-JOHNS</b> , clamps bulldog	11
<b>GOSSET</b> , écarteurs abdominaux	298	<b>HOPKINS-JOHNS</b> , pinces à dissection et à ligatures	32
<b>GRADLE</b> , pinces à épiler les cils	76	<b>HOPKINS-JOHNS</b> , pinces à poser	11
<b>GRAEFE</b> , ciseaux oculaires	126	<b>HORNE-JOBSON</b> , porte-coton	312
<b>GRAEFE</b> , crochets très fins	243	<b>HÖSEL</b> , porte-aiguilles	188
<b>GRAEFE</b> , pinces à fixer	84	<b>HÖSEL</b> , porte-aiguilles tungstène TUC	201
<b>GRAEFE</b> , pinces à iris	79	<b>HOSPITAL-PROVIDENCE</b> , pinces hémostatiques	16
<b>GRAY</b> , pinces-clamps pour voies biliaires	40	<b>HRYNTSCHAK-YOUNG</b> , porte-aiguilles	189
<b>GRAZIL</b> , ciseaux à chirurgie	103	<b>HUDSON</b> , perforateurs à main	387
<b>GREEN</b> , pinces à fixer	84	<b>HUMBY</b> , dermatome	176
<b>GREEN-SENN</b> , écarteurs fins	247	<b>HUNT</b> , pinces	70
<b>GROSS-MAIER</b> , pinces à pansements	230, 231	<b>HUNTER</b> , pinces à échardes	73
<b>GRUENWALD (JANSEN)</b> , pinces nasales	78	<b>HURD</b> , aiguilles à ligatures	218
<b>GRUENWALD</b> , pinces nasales	78		
<b>GUTHRIE</b> , crochets très fins	246	<b>I</b>	
<b>GUYON</b> , pinces-clamps pour pédicules rénaux	38, 39	Instrumentation pour les clous de Küntscher	488, 489
<b>GUYON-ARTRAUMATIC</b> , pinces-clamps pour pédicules rénaux	39	Instruments à écorcher les tendons	465
		Instruments à noeuds	223
<b>H</b>		Instruments pour mesurer	371-375
<b>HABERER</b> , spatules abdominaux	308	Instruments pour saisir les tendons	464
<b>HAJEK</b> , marteaux	429	Instruments sensibilités	376
<b>HALLE</b> , ciseaux nasaux	120	<b>IOWA</b> , aiguilles spéciales	345
<b>HALSEY</b> , porte-aiguilles	181	<b>ISRAEL</b> , écarteurs	253
<b>HALSEY</b> , porte-aiguilles tungstène TUC	195	<b>IVES-FANSLER</b> , sphinctérosopes	538
<b>HALSTED</b> , pinces hémostatiques	16	<b>IWANSON</b> , cerde	375
<b>HALSTED-MOSQUITO</b> , pinces hémostatiques	15		
<b>HARMAN-BISHOP</b> , pinces à iris	82	<b>J</b>	
<b>HARMS</b> , pinces pour sutures	86	<b>JACKSON</b> , laryngoscopes à Lumière foie	363
<b>HARRINGTON</b> , écarteurs	267	<b>JACKSON</b> , pinces à pansements	78
<b>HARRISON (PYE-SMITH)</b> , pinces à stérilisation	564	<b>JACOBI</b> , aiguilles à ligatures	217
<b>HARTMANN</b> , pinces hémostatiques	14	<b>JACOBS CHUCK</b> , perforateurs à main	388
<b>HARTMANN</b> , pinces-gouges	469	<b>JACOBSON</b> , micro-porte-aiguilles	210
<b>HARVEY</b> , ciseaux pour fils	130	<b>JACOBSON</b> , micro-porte-aiguilles tungstène TUC	204
<b>HATFIELD</b> , curettes tranchantes	439	<b>JACOBSON</b> , porte-aiguilles	182
<b>HEANEY</b> , écarteurs	277	<b>JACOBSON</b> , porte-aiguilles tungstène TUC	194
<b>HEANEY</b> , pinces à hystérectomie	43	<b>JAMESON</b> , pied à coulisse	372
<b>HEANEY</b> , porte-aiguilles	184	<b>JAMESON</b> , pinces musculaires	87
<b>HEANEY-BALLANTINE</b> , pinces à hystérectomie	43	<b>JAMESON</b> , porte-aiguilles	184
<b>HEANEY-KANTER</b> , pinces à hystérectomie	43	<b>JANET</b> , seringues	348
<b>HEANEY-REZAK</b> , pinces à hystérectomie	44	<b>JANSEN (GRUENWALD)</b> , pinces nasales	78
<b>HEATH</b> , ciseaux à ligatures	129	<b>JANSEN</b> , curettes tranchantes	440
<b>HEATH-RICHTER</b> , pinces pour agrafes	224	<b>JANSEN</b> , écarteurs autostatiques	284
<b>HEGAR-OLSEN</b> , porte-aiguilles	185	<b>JANSEN</b> , pinces nasales	77
<b>HEGAR-OLSEN</b> , porte-aiguilles tungstène TUC	198	<b>JAPAN-TOHOKU</b> , pinces à champs	52
<b>HEGEMANN-DIETRICH</b> , ciseaux vasculaires	114	<b>JEWELER</b> , pinces à dissection tungstène TUC	92
<b>HEGENBARTH</b> , pinces pour agrafes	224	<b>JOBSON-HORNE</b> , porte-coton	312
<b>HEIFETZ</b> , pinces	70	<b>JOHANSSON</b> , trocars	329
<b>HEISS</b> , pinces-clamps à bronches	30	<b>JOHNS-HOPKINS</b> , clamps bulldog	11
<b>HELPERICH-BIER</b> , scies à amputation	384	<b>JOHNS-HOPKINS</b> , pinces à dissection et à ligatures	32
<b>HEMINGWAY</b> , curettes tranchantes	441	<b>JOHNS-HOPKINS</b> , pinces à poser	11
<b>HENAHAN</b> , crochet à dent de sagesse	481	<b>JONES</b> , pinces à champs	51
<b>HENLEY</b> , écarteurs autostatiques	288	<b>JOSEPH</b> , ciseaux à dissection	112
<b>HENNIG</b> , pinces écartante pour appareils plâtrés	319	<b>JOSEPH</b> , crochets très fins	246
<b>HERRICK</b> , pinces-clamps pour pédicules rénaux	39	<b>JUDD-ALLIS</b> , pinces pour saisir le tissu et l'intestin	518
<b>HESS</b> , pinces à iris	81		
<b>HESSBERG</b> , aiguilles à ligatures	217	<b>K</b>	
<b>HESS-GILL</b> , pinces à iris	82	<b>KADER</b> , écarteurs	273
<b>HEYMANN</b> , ciseaux nasaux	120	<b>KALT</b> , micro-porte-aiguilles	212
<b>HEYWOOD-SMITH</b> , pinces à éponges	236	<b>KALT</b> , micro-porte-aiguilles tungstène TUC	205
<b>HIBBS</b> , ciseaux-burins	420	<b>KALT-ARRUGA</b> , micro-porte-aiguilles	212
<b>HIBBS</b> , ostéotomes	420		
<b>HIRSCHMANN</b> , anuscopes	539		
<b>HOEN</b> , élévateurs	448		
<b>HOESEL</b> , écarteurs	265		



	Page		Page
<b>KALT-CASTROVIEJO</b> , micro-porte-aiguilles	212	Lampes à alcool	556
<b>KANTER-HEANEY</b> , pinces à hystérectomie	43	<b>LANDAU</b> , trocars	329
<b>KANTROWITZ</b> , pinces à dissection et à ligatures	35	<b>LANDAU-SEGOND</b> , pinces à hystérectomie	45
<b>KAPLAN-CRANE</b> , pinces pour cul-de-sac	98	<b>LANDGRAF</b> , précelles (brucelles) pour coton	97
<b>KATZIN</b> , ciseaux cornéales	142	<b>LANDOLT</b> , ciseaux fins	124
<b>KATZIN-BARRAQUER</b> , ciseaux cornéales	142	<b>LANE</b> , daviers porte-os	457
<b>KAYE</b> , ciseaux pour Face-lift	161	<b>LANE</b> , pinces à champs	51
<b>KELLY (RICHARDSON)</b> , écarteurs	264	<b>LANE</b> , pinces à griffes	61
<b>KELLY</b> , ciseaux pour fistules	106	<b>LANE</b> , pinces-clamps stomacales	531
<b>KELLY</b> , ciseaux tungstène TUC	153	<b>LANE</b> , tournevis	491
<b>KELLY</b> , écarteurs	268	<b>LANGE</b> , ciseaux pour pansements	132
<b>KELLY</b> , pinces à éponges	235	<b>LANGE</b> , pinces pour agrafes	225
<b>KELLY</b> , pinces hémostatiques	17	<b>LANGE-HOHMANN</b> , leviers à os	397
<b>KELLY</b> , proctoscopes	540, 541	<b>LANGENBECK</b> , couteaux à amputation	172
<b>KELLY-RANKIN</b> , pinces hémostatiques	17	<b>LANGENBECK</b> , daviers porte-os	455
<b>KELMAN-McPHERSON</b> , pinces pour sutures	85	<b>LANGENBECK</b> , écarteurs	254, 258
<b>KERN</b> , daviers porte-os	456	<b>LANGENBECK</b> , élévateurs	447
<b>KERSTING</b> , pince à anastomose	528	<b>LANGENBECK</b> , porte-aiguilles	188
<b>KILNER (RAGNELL)</b> , ciseaux à dissection	112	<b>LANGENBECK</b> , porte-aiguilles tungstène TUC	202
<b>KILNER</b> , crochets très fins	242	<b>LANGENBECK</b> , rugines-raspatoires	443
<b>KILNER</b> , porte-aiguilles	181	<b>LANGENBECK</b> , scies à résection	384
<b>KILNER</b> , porte-aiguilles tungstène TUC	195	<b>LANGENBECK-DELICATE</b> , porte-aiguilles tungstène TUC	202
<b>KIRBY</b> , pinces à iris	82	<b>LANGENBECK-KOCHER</b> , écarteurs	259
<b>KIRSCHNER</b> , broches	499-502	<b>LANGENBECK-MINI</b> , écarteurs fins	247
<b>KIRSCHNER</b> , canules d'aspiration	503	<b>LANGENBECK-PARKER</b> , écarteurs	278
<b>KIRSCHNER</b> , écarteurs abdominaux	303	<b>LANGENBECK-RYDER</b> , porte-aiguilles tungstène TUC	202
<b>KIRSCHNER</b> , étriers à extension	400	Laryngoscopes	353-360
<b>KIRSCHNER</b> , sondes conductrices	222	Laryngoscopes à lumière froide	357-360
<b>KIRSCHNER-FERROZELL</b> , sondes conductrices	222	<b>LAWRENCE</b> , pinces à dissection et à ligatures	34
<b>KLEINERT-KUTZ</b> , crochets très fins	242	<b>LEKSELL-STILLE</b> , pinces-gouges	473
<b>KLEINERT-KUTZ</b> , instruments pour saisir les tendons	464	<b>LEMPERT</b> , pinces-gouges	470
<b>KLEINERT-KUTZ</b> , pinces-gouges	471	<b>LERICHE</b> , pinces hémostatiques	16
<b>KLIMA-ROSSEGER</b> , aiguilles à biopsie	343	<b>LESTER</b> , pinces à fixer	84
<b>KLINIKUM BERLIN</b> , presses-tube	53	Leviers à os	395-398
<b>KLINKENBERGH-LOTH</b> , ciseaux vasculaires	117	<b>LEWIN</b> , daviers porte-os	454
<b>KNAPP</b> , crochets très fins	246	<b>LEXER</b> , ciseaux à dissection	111
<b>KNIGHTON</b> , écarteurs autostatiques	297	<b>LEXER</b> , ciseaux tungstène TUC	158
<b>KNOWLES</b> , ciseaux pour pansements	133	<b>LEXER</b> , ciseaux-burins	422, 423
<b>KOCHER</b> , aiguilles à ligatures	216	<b>LEXER</b> , ostéotomes	422, 423
<b>KOCHER</b> , écarteurs	251, 260, 266	<b>LEXER-BABY</b> , ciseaux à dissection	111
<b>KOCHER</b> , pinces-clamps stomacales e pour l'intestin	522, 525	<b>LICHTENBERG</b> , porte-aiguilles	187
<b>KOCHER</b> , pinces-clamps stomacales e pour l'intestin Atrauma	525	<b>LICHTENBERG</b> , porte-aiguilles tungstène TUC	201
<b>KOCHER</b> , sondes conductrices	222	<b>LICHTWITZ</b> , trocars	330
<b>KOCHER-DELICATE</b> , pinces hémostatiques	22	Ligateurs hémoïroïdes	552-554
<b>KOCHER-LANGENBECK</b> , écarteurs	259	<b>LIGHTWEIGHT-DUPLEX/BABY</b> , stéthoscopes	378
<b>KOCHER-OCHSNER</b> , pinces hémostatiques	20, 21	Limes à ongles	579
<b>KOERTE</b> , écarteurs	252, 267	Limes à os	450
<b>KÖNIG</b> , ciseaux pour ongles incarnés	135	<b>LINCOLN</b> , ciseaux vasculaires	117
<b>KÖNIG</b> , sondes conductrices	221	<b>LINDEMANN</b> , scies à résection	384
<b>KRAUSE</b> , trocars	330	<b>LISTER</b> , ciseaux pour pansements	133, 134
<b>KROENLEIN</b> , pinces à saisir	13	<b>LISTER</b> , ciseaux tungstène TUC	162
<b>KRONECKER</b> , aiguilles à ligatures	218	<b>LISTER</b> , pinces à tampons	228
<b>KUEHNE</b> , pinces porte-lamelles	78	<b>LISTER-EXCENTRIC</b> , ciseaux pour pansements	133
<b>KÜNTSCHER</b> , clous centromédullaires	492-494	<b>LISTON</b> , couteaux à amputation	172
<b>KÜNTSCHER</b> , instrumentation pour les clous	488, 489	<b>LISTON</b> , pinces coupantes à os	477, 480
<b>KUTZ-KLEINERT</b> , crochets très fins	242	<b>LISTON-KEY</b> , pinces coupantes à os	479
		<b>LITTAUER</b> , ciseaux à ligatures	128
<b>L</b>		<b>LITTAUER</b> , pinces à épiler les cils	76
		<b>LITTAUER</b> , pinces à ongle	569
<b>LA GRANGE</b> , ciseaux oculaires	126	<b>LITTAUER-LISTON</b> , pinces coupantes à os	477
<b>LAHEY</b> , écarteurs	263	<b>LITTLE</b> , écarteurs	263
<b>LAHEY</b> , pinces-clamps pour voies biliaires	37	<b>LITTLER</b> , ciseaux fins	123
<b>LAMBOTTE</b> , daviers porte-os	460	<b>LITTLEWOOD</b> , pinces pour saisir le tissu et l'intestin	518
<b>LAMBOTTE</b> , ostéotomes	426	<b>LLOYD-DAVIS</b> , pince à anastomose	529
<b>LAMBOTTE</b> , rugines-raspatoires	443	<b>LOCKHART-MUMMERY</b> , sondes	311
Lames de bistouris	167, 168	<b>LOCKLIN</b> , ciseaux à gencives	136
Lames de rasoir	177	<b>LOCKLIN</b> , ciseaux tungstène TUC	162
Lames pour scies électriques	323	<b>LOCKWOOD</b> , pinces pour saisir le tissu et l'intestin	518
<b>LAMPERT</b> , pinces à chalazion	89	<b>LOCKWOOD-ALLIS</b> , pinces pour saisir le tissu et l'intestin	518



	Page		Page
<b>LONDON COLLEGE</b> , précelles (Brucelles) pour coton	95	<b>MC INDOE</b> , pinces à dissection	60
<b>LONG</b> , pinces à hystérectomie	44	<b>MC INDOE</b> , pinces coupantes à os	478
<b>LORENZ</b> , ciseaux pour pansements	133	<b>MC INTOSH</b> , Fibre Optic laryngoscopes	357
<b>LORNA</b> , pinces à champs	52	<b>MC INTOSH</b> , laryngoscopes	353
<b>LOTH-KLINKENBERGH</b> , ciseaux vasculaires	117	<b>McDONALD</b> , éleveurs	448
<b>LOTH-SCHOEMAKER</b> , ciseaux à ligatures	128	<b>McDONALD</b> , pinces à capsulorhexis	90
<b>LOUTE</b> , tendeurs serre-fils	407	<b>McPHERSON</b> , pinces pour sutures	85
<b>LOVELACE-DIXON</b> , pinces hémostatiques	26	<b>McPHERSON-KELMAN</b> , pinces pour sutures	85
<b>LOWER</b> , pinces-clamps pour voies biliaires	37	<b>MEAD</b> , marteaux	430
<b>LUCAE</b> , marteaux	430	<b>MEAD</b> , pinces-gouges	469
<b>LUCAE</b> , pinces nasales	77	<b>MEEKER</b> , pinces à dissection et à ligatures	25
<b>LUCAS</b> , ciseaux-burins	417	<b>MENGHINI</b> , aiguilles à biopsie	344
<b>LUCAS</b> , curettes tranchantes	441	<b>MERIAM</b> , précelles (brucelles) pour coton	96
<b>LUER</b> , canules d'aspiration	336	Mesures graduées	556, 559
<b>LUER</b> , pinces-clamps à hémorroïdes, atrauma	48	<b>METZENBAUM</b> , ciseaux à dissection	108
<b>LUER</b> , pinces-gouges	469	<b>METZENBAUM</b> , ciseaux tungstène TUC	155, 156
<b>LUETHY-BECK</b> , porte-aiguilles tungstène TUC	202	<b>METZENBAUM</b> , porte-aiguilles tungstène TUC	199
<b>M</b>			
<b>MAGILL</b> , pinces pour sondes	360	<b>METZENBAUM-BABY</b> , ciseaux à dissection	108
<b>MAIER-GROSS</b> , pinces à pansements	230, 231	<b>METZENBAUM-DELICATE</b> , ciseaux à dissection	110
<b>MAIER-SIMS</b> , pinces à pansements	239	<b>METZENBAUM-DELICATE</b> , ciseaux tungstène TUC	158-160
Manches en plomb	482	<b>METZENBAUM-NELSON</b> , ciseaux à dissection	109
Manches pour bistouris	165-167	<b>MEYERDING</b> , écarteurs	273
Manches pour canules de liposuction et infiltration	338, 340	<b>MEYERDING</b> , écarteurs autostatiques	294
<b>MARKHAM-MEYERDING</b> , écarteurs autostatiques	294	<b>MEYERDING</b> , écarteurs fins	247
<b>MARKWALDER</b> , pinces coupantes à os	477	<b>MEYERDING-MARKHAM</b> , écarteurs autostatiques	294
<b>MARQUARDT</b> , pinces-gouges	470	<b>MICHEL</b> , agrafes	225
Marqueur pour Facelift	376	<b>MICHEL</b> , pinces pour agrafes	224
Marteaux	427-433	<b>MICRO-ADSON</b> , pinces à dissection et à griffes	59
Marteaux-percuteurs	369, 370	Micro-ciseaux	143-149
<b>MARTEL</b> , pinces hémostatiques pour le cuir chevelu	12	<b>MICRO-FRIEDMAN</b> , pinces-gouges	476
<b>MARTEL-WILLET</b> , pinces hémostatiques pour le cuir chevelu	12	<b>MICRO-MOSQUITO</b> , pinces hémostatiques	15
<b>MARTIN</b> , daviers à cartilage	453	Micro-pinces	71, 72
<b>MARTIN</b> , écarteurs	262	Micro-porte-aiguilles	204-213
<b>MARTIN-CARTILAGE</b> , ciseaux	118	Micro-porte-aiguilles à manches rondes	206-209
<b>MARTINI</b> , curettes tranchantes	440	Micro-porte-aiguilles tungstène TUC	204, 205
<b>MASS.-GENERAL-HOSPITAL (M.G.H.)</b> , porte-aiguilles	183	<b>MICRO-RYDER</b> , porte-aiguilles tungstène TUC	193
<b>MASSE-ROBIN</b> , écarteurs abdominaux	306	<b>MICROVASCULAR</b> , porte-aiguilles tungstène TUC	193
<b>MASSON</b> , porte-aiguilles	184	<b>MICRO-WULLSTEIN</b> , canules d'aspiration	335
<b>MASSON</b> , porte-aiguilles tungstène TUC	197	<b>MIDDELDORPF</b> , écarteurs	264
<b>MATHIEU</b> , écarteurs	278	<b>MIKULICZ</b> , écarteurs	268
<b>MATHIEU</b> , porte-aiguilles	186	<b>MIKULICZ</b> , pinces-clamps pour le péritoine	49
<b>MATHIEU</b> , porte-aiguilles tungstène TUC	199	<b>MIKULICZ-BABY</b> , pinces-clamps pour le péritoine	49
<b>MATHIEU</b> , spéculums rectaux	536	<b>MILLER</b> , Fibre Optic laryngoscopes	359
<b>MATHIEU-DELICATE</b> , porte-aiguilles	186	<b>MILLER</b> , laryngoscopes	355
<b>MATHIEU-DELICATE</b> , porte-aiguilles tungstène TUC	199	<b>MILLER</b> , pinces pour papier à articulat	98
<b>MATHIEU-RYDER VASCULAR</b> , porte-aiguilles tungstène TUC	200	<b>MILLER-SENN</b> , écarteurs fins	250
<b>MATHIEU-RYDER</b> , porte-aiguilles tungstène TUC	200	<b>MILLER-SENN-BABY</b> , écarteurs fins	250
<b>MATSON</b> , rugines-raspatoires	446	<b>MILLIGAN</b> , écarteurs autostatiques	288
<b>MAYFIELD</b> , pinces-gouges	470	<b>MILLS</b> , ciseaux vasculaires	116
<b>MAYO ROBSON</b> , pinces-clamps stomacales e pour l'intestin Atrauma	526	<b>MINI</b> , lames de bistouris	167
<b>MAYO</b> , ciseaux	105	<b>MINI</b> , manches de bistouris	167
<b>MAYO</b> , ciseaux tungstène TUC	153	<b>MINI-FRIEDMAN</b> , pinces-gouges	468
<b>MAYO</b> , clips de stérilisation	564	<b>MINI-HOHMANN</b> , leviers à os	395
<b>MAYO-ADAMS</b> , écarteurs autostatiques	296	<b>MINI-LAMBOTTE</b> , ostéotomes	426
<b>MAYO-HARRINGTON</b> , ciseaux	105	<b>MINI-LANGENBECK</b> , écarteurs fins	247
<b>MAYO-HEGAR</b> , porte-aiguilles	184	<b>MINI-LEXER</b> , ciseaux-burins	422
<b>MAYO-HEGAR</b> , porte-aiguilles tungstène TUC	192	<b>MINI-LEXER</b> , ostéotomes	422
<b>MAYO-HEGAR-DELICATE</b> , porte-aiguilles	184	Miroirs frontaux	367
<b>MAYO-HEGAR-DELICATE</b> , porte-aiguilles tungstène TUC	192	<b>MISKIMON</b> , écarteurs autostatiques	289
<b>MAYO-NOBLE</b> , ciseaux	105	<b>MIXTER</b> , ciseaux à chirurgie	104
<b>MAYO-ROBSON</b> , pinces-clamps stomacales et pour l'intestin	521, 526	<b>MIXTER</b> , pinces à dissection et à ligatures	33, 34
<b>MAYO-RUSS.</b> , pinces pour saisir les tissus	66	<b>MIXTER-BABY</b> , pinces à dissection et à ligatures	33
<b>MAYO-STILLE</b> , ciseaux	105	<b>MIXTER-O'SHAUGNESSY</b> , pinces à dissection et à ligatures	33
<b>MAYO-STILLE</b> , ciseaux tungstène TUC	154	<b>MIXTER-OVERHOLT</b> , pinces à dissection et à ligatures	29
<b>MC GIVNEY</b> , ligateurs hémorroïdes	553	<b>MOD. BONN</b> , ciseaux fins	124
<b>MC INDOE</b> , ciseaux	118	<b>MOD. BONN</b> , pinces à iris	81
		<b>MOD. BONN</b> , pinces pour sutures	86
		<b>MOD. TÜBINGEN</b> , pinces pour sutures	86
		<b>MOD. USA</b> , ciseaux pour le cordon ombilical	121

	Page		Page
<b>MOD. WIEN</b> , instruments pour la suture	223	<b>OVERHOLT-GEISSENDOERFER</b> , pinces à dissection et à ligatures	23
<b>MODELL TÜBINGEN</b> , écarteurs	262	<b>OVERHOLT-MIXTER</b> , pinces à dissection et à ligatures	29
<b>MODELL TÜBINGEN</b> , écarteurs autostatiques	296		
<b>MODELL USA</b> , pinces à dissection et à griffes	59	<b>P</b>	
<b>MODELL USA</b> , pinces écartantes pour appareils plâtrés	319	<b>PALMER</b> , clous à os	496
<b>MOELTGEN</b> , goniomètre	373	Pansements	318-324
<b>MOLDESTAD</b> , crochets très fins	244	<b>PARAMETRIUM</b> , ciseaux tungstène TUC	154
<b>MOLLISON</b> , écarteurs autostatiques	289	<b>PARAMETRIUM</b> , pinces-clamps pour parametrium	46
<b>MOLT</b> , rugines-raspatoires	444	<b>PARKER</b> , écarteurs	278
<b>MOORE</b> , perforateurs à main	387	<b>PARKER-LANGENBECK</b> , écarteurs	278
<b>MOORFIELD</b> , pinces pour sutures	84	<b>PARTSCH</b> , ciseaux-burins	418
<b>MORGAN</b> , anuscopes	541	<b>PARTSCH</b> , marteaux	430
<b>MORGAN</b> , luce fredda	541	<b>PATON</b> , micro-porte-aiguilles	212
<b>MORRIS</b> , écarteurs	261	<b>PAUFIQUE</b> , pinces pour sutures	86
<b>MOSQUITO-HALSTED</b> , pinces hémostatiques	15	<b>PAYR</b> , pinces-clamps et écraseurs	530
<b>MOSQUITO-MICRO</b> , pinces hémostatiques	15	<b>PAYR</b> , sondes conductrices	221
<b>MOYNIHAN</b> , pinces à hystérectomie	44	<b>PAYR-BABY</b> , pinces-clamps et écraseurs	530
Multiple approach retractor	282	<b>PAYR-SCHMIEDEN</b> , sondes conductrices	221
<b>MUMMERY-LOCKHART</b> , sondes	311	<b>PEAN</b> , pinces à saisir	13
<b>MYRTLE LEAF</b> , sondes	310	<b>PEAN-DELICATE</b> , pinces hémostatiques	22
		<b>PEAN-ROCHESTER</b> , pinces hémostatiques	18, 19
<b>N</b>		<b>PEERS</b> , pinces à champs	52
<b>NABATOFF</b> , trousse à varices	312	<b>PEET</b> , pinces à échardes	75
<b>NAGER</b> , aiguilles à ligatures	219	<b>PELKMANN</b> , pinces à tampons	235
<b>NEFF</b> , bistouris à ménisques	467	<b>PENNINGTON</b> , pinces à saisir	13
<b>NEGUS</b> , pinces-clamps pour voies biliaires	40	<b>PERCY</b> , retracteur pour amputation	463
<b>NEIVERT</b> , porte-aiguilles	181	Perforateurs à main	385-390
<b>NEIVERT</b> , porte-aiguilles tungstène TUC	195	<b>PERRY</b> , précelles (brucelles) pour coton	97
<b>NELATON</b> , sondes	310	<b>PERTHES</b> , perforateurs à main	390
<b>NELSON</b> , pinces pour saisir les tissus	66	<b>PHANEUF</b> , pinces à hystérectomie	45
<b>NELSON</b> , trocars	328	<b>PHILIPS</b> , tournevis	491
<b>NELSON-METZENBAUM</b> , ciseaux à dissection	109	<b>PIERCE</b> , trocars	330
<b>NERVE</b> , micro-ciseaux	147	<b>PIFFARD</b> , curettes tranchantes	436
<b>NEUMANN</b> , ciseaux à gencives	137	Pilons	451
<b>NEW ORLEANS</b> , porte-aiguilles	183	<b>PINARD</b> , Stéthoscopes	377
<b>NEW ORLEANS</b> , porte-aiguilles tungstène TUC	194	Pince-guide pour perforateurs	390
<b>NIRO</b> , pinces à fil	401	Pinces à anastomose	528, 529, 532, 533
<b>NOBLE-MAYO</b> , ciseaux	105	Pinces à capsulorhexis	90
<b>nopa PROFI</b> , scie à autopsie	484	Pinces à chalazion	88, 89
<b>NORTHBENT</b> , ciseaux à ligatures	129	Pinces à champs	51, 52
<b>NOTO</b> , pinces à éponges	234	Pinces à compresses	51, 52
<b>NOYES</b> , ciseaux à iridectomie	138	Pinces à dissection	23-25, 29, 31-36, 57-65
<b>NUSSBAUM</b> , pinces-clamps stomacales et pour l'intestin	523	Pinces à dissection tungstène TUC	92-94
		Pinces à échardes	73-75
<b>O</b>		Pinces à entropion	88
<b>O'BRIAN</b> , ciseaux fins	124	Pinces à épiler les cils	76
<b>OBWEGESER</b> , écarteurs pour parties molles	255, 256	Pinces à éponges	228-239
<b>OBWEGESER</b> , écarteurs pour ramus	257	Pinces à fil	401-403, 405, 406
<b>OCHSNER</b> , trocars	329	Pinces à fixer	84
<b>OCHSNER-KOCHER</b> , pinces hémostatiques	20, 21	Pinces à griffes	57-65, 67, 68
<b>O'CONNOR</b> , crochets très fins	243	Pinces à hystérectomie	41-45
<b>O'CONNOR-O'SULLIVAN</b> , écarteurs abdominaux	301	Pinces à iris	79-82
<b>OEHLER</b> , oubces à dissection tungstène TUC	92	Pinces à ligatures	23-25, 29, 31-36
<b>OLIVECRONA</b> , ciseaux vasculaires	117	Pinces à ligatures avec plate-forme	71, 72
<b>OLLIER</b> , écarteurs	253	Pinces à ongle	568-570
<b>OLSEN-HEGAR</b> , porte-aiguilles	185	Pinces à pansements	78, 229-239
<b>OLSEN-HEGAR</b> , porte-aiguilles tungstène TUC	198	Pinces à poser	11
<b>OLSEN-HEGAR-USA</b> , porte-aiguilles tungstène TUC	198	Pinces à saisir	12, 13, 316
<b>OMBREDANNE</b> , marteaux	427	Pinces à stérilisation	564
<b>OSCINOPA</b> , scie à autopsie	483	Pinces à tampons	229-239
<b>OSCINOPA</b> , scie électrique pour appareils plâtrés	321	Pinces à tenir de cristallins	90
<b>O'SHAUGNESSY-MIXTER</b> , pinces à dissection et à ligatures	33	Pinces à torsader le fil tungstène TUC	203
Ostéotomes	417-426	Pinces atrauma	91
<b>O'SULLIVAN-O'CONNOR</b> , écarteurs abdominaux	301	Pinces auriculaires	29,77
<b>OTOSKOP UNI</b> , trousse à diagnostic	381	Pinces capsulaires	83
<b>OVERHOLT</b> , pinces à disséquer et à ligatures	24	Pinces coupantes à os	477-480
<b>OVERHOLT-BABY</b> , pinces à dissection et à ligatures	23	Pinces de reposition	487
		Pinces de suture	97



	Page		Page
Pinces d'horloger	69	<b>PROVIDENCE-HOSPITAL</b> , pinces hémostatiques	16
Pinces écartantes pour appareils plâtrés	319	<b>PUTTI</b> , râpes	451
Pinces emporte-pièces à biopsie rectale	551	<b>PYE-SMITH (HARRISON)</b> , pinces à stérilisation	564
Pinces hémostatiques	9-53	<b>PYNCHON-ANDREWS</b> , canules d'aspiration	331
Pinces hémostatiques fines	15		
Pinces hémostatiques gracieles	22	<b>Q</b>	
Pinces hémostatiques pour amygdales	27	<b>QUINBY</b> , ciseaux à gencives	137
Pinces hémostatiques pour le cuir chevelu	12, 26	<b>QUINKE</b> , aiguilles à biopsie	344
Pinces micro	71, 72		
Pinces musculaires	87, 88	<b>R</b>	
Pinces nasales	77, 78	<b>RABINER</b> , marteaux-percuteurs	369
Pinces plates	404	Raccords	349
Pinces porte-lamelles	78	<b>RADOLF</b> , pince à angle	482
Pinces pour agrafes	224, 225	<b>RAGNELL (KILNER)</b> , ciseaux à dissection	112
Pinces pour cul-de-sac	98	<b>RAGNELL-DAVIS</b> , écarteurs fins	250
Pinces pour la chambre antérieure	85	<b>RALK</b> , perforateurs à main	389
Pinces pour papier à articulat	98	<b>RALK</b> , pinces à échardes	75
Pinces pour saisir le tissu	9, 517, 518	<b>RAMPLEY</b> , pinces à éponges	238
Pinces pour saisir les tissus	9, 66-68, 70, 316	<b>RANKIN-CRILE</b> , pinces hémostatiques	17
Pinces pour saisir l'intestin	9, 517-519	<b>RANKIN-KELLY</b> , pinces hémostatiques	17
Pinces pour sondes	360	Râpes	451
Pinces pour suture	85, 86	Récipients cylindriques	562
Pinces vasculaire	12	Rectoscopes	544-550
Pinces-clamps à anastomose	532, 533	<b>REHN</b> , couteaux à transplantation	175
Pinces-clamps à bronches	30	<b>REILL</b> , micro-porte-aiguilles	207
Pinces-clamps à hémorroïdes	47, 48	<b>REINER</b> , couteaux pour appareils plâtrés	318
Pinces-clamps à hémorroïdes, atrauma	48	<b>RESANO</b> , pinces-clamps stomacales et pour l'intestin	527
Pinces-clamps à pression progressive	47, 48	Retracteur pour amputation	463
Pinces-clamps et écraseurs pour l'intestin et l'estomac	530	<b>REVERDIN</b> , aiguilles	214
Pinces-clamps intestinales	532, 533	<b>REVERDIN</b> , spatules abdominales	308
Pinces-clamps pour le péritoine	49, 50	<b>REYNOLDS</b> , ciseaux à dissection	112
Pinces-clamps pour l'intestin et stomacales	520-523	<b>REZAK-HEANEY</b> , pinces à hystérectomie	44
Pinces-clamps pour parametrium	46	<b>RIBBON</b> , ciseaux oculaires	127
Pinces-clamps pour pédicules rénaux	37-39	<b>RICARD</b> , écarteurs abdominaux	306
Pinces-clamps pour voies biliaires	37, 40	<b>RICHARDSON (KELLY)</b> , écarteurs	264
Pinces-clamps stomacales e pour l'intestin Atrauma	524-527	<b>RICHARDSON-EASTMAN</b> , écarteurs	264
Pinces-clamps stomacales et pour l'intestin	520-523	<b>RICHTER</b> , ciseaux à chirurgie	104
Pinces-gouges	468-476	<b>RICHTER-HEATH</b> , pinces pour agrafes	224
Pincettes pour casser les lames	177	<b>RIGHBY</b> , écarteurs autostatiques	295
Pistolet laveur	590, 591	<b>RIRAP</b> , stéthoscopes	378
Plaquettes en carbure de tungstène	190, 191	<b>RISCOPE S</b> , troussees ophthalmologiques	381
Plateaux pour instruments	561	<b>RISCOPE S</b> , troussees oto-/ophthalmologiques	380
<b>PLESTER</b> , canules d'aspiration	335	<b>ROBERTS</b> , pinces-clamps à bronches	30
<b>PLESTER</b> , écarteurs autostatiques	295	Robinets	349
Ponction	327-349	<b>ROBIN-MASSÉ</b> , écarteurs abdominaux	306
<b>POOLE</b> , canules d'aspiration	332	<b>ROCHESTER-CARMALT</b> , pinces hémostatiques	27
<b>POOLE-BABY</b> , canules d'aspiration	332	<b>ROCHESTER-PEAN</b> , pinces hémostatiques	18, 19
Porte-aiguilles	180-213	<b>ROEDER</b> , pinces à champs	52
Porte-aiguilles tungstène TUC	192-205	<b>ROETTGEN-RUSKIN</b> , pinces-gouges	473
Porte-coton	311, 312	<b>ROGGE</b> , pinces à stérilisation	564
Porte-ligature	223	<b>ROLLET</b> , crochets très fins	246
<b>POTTS-DE MARTEL</b> , ciseaux vasculaires	116	<b>ROSCHKE</b> , anuscopes	537
<b>POTTS-SMITH</b> , ciseaux	118	<b>ROSSEGGER-KLIMA</b> , aiguilles à biopsie	343
<b>POTTS-SMITH</b> , ciseaux tungstène TUC	157	<b>ROTTER</b> , aiguilles à ligatures	219
<b>POTTS-SMITH</b> , ciseaux vasculaires	113, 115	<b>ROUX</b> , écarteurs	277
<b>POTTS-SMITH</b> , micro-porte-aiguilles	212	<b>ROWE</b> , pinces de reposition	487
<b>POTTS-SMITH</b> , micro-porte-aiguilles tungstène TUC	205	<b>RUDD</b> , ligateurs hémorroïdes	554
<b>POTTS-SMITH</b> , pinces à dissection et à griffes	63	Rugines-Raspatoires	442-446
<b>POTTS-SMITH</b> , pinces à dissection tungstène TUC	92	<b>RUMEL</b> , pinces à dissection et à ligatures	31
<b>PRATT</b> , pinces-clamps à hémorroïdes	47	<b>RUSKIN</b> , pinces-gouges	471, 475
<b>PRATT</b> , sonde fistulaire	311	<b>RUSKIN-LISTON</b> , pinces coupantes à os	478
<b>PRATT</b> , spéculums rectaux	536	<b>RUSKIN-MINI</b> , pinces-gouges	471
Précélles pour coton	95-97	<b>RUSS. MODELL</b> , pinces pour saisir les tissus	68
<b>PRECISA</b> , tensiomètre à mercure	379	<b>RUSS.-MAYO</b> , pinces pour saisir les tissus	66
<b>PRESBYTERIAN</b> , presses-tube	53	<b>RYDER MICRO</b> , porte-aiguilles tungstène TUC	193
Presses-tube	53	<b>RYDER/FRENCH EYE</b> , porte-aiguilles tungstène TUC	193
<b>PRINCE</b> , ciseaux pour les amygdales	119	<b>RYDER-LANGENBECK</b> , porte-aiguilles tungstène TUC	202
<b>PRINCE</b> , pinces musculaires	87		
Proctoscopes	537-543		

	Page		Page
<b>RYDER-MATHIEU VASCULAR</b> , porte-aiguilles tungstène TUC	200	<b>SIMON</b> , écarteurs	262
<b>RYDER-MATHIEU</b> , porte-aiguilles tungstène TUC	200	<b>SIMS</b> , ciseaux à gynécologie	107
<b>S</b>		<b>SIMS</b> , ciseaux tungstène TUC	155
<b>SALAH</b> , aiguilles à biopsie	343	<b>SIMS</b> , spéculums rectaux	534
<b>SALENIUS</b> , bistouris à ménisques	467	<b>SIMS-MAIER</b> , pinces à pansements	239
<b>SAMII</b> , pinces	70	<b>SINGLEY-TUTTLE</b> , pinces pour saisir les tissus	66
<b>SANVENERO</b> , ciseaux à dissection	112	<b>SINUSCOPY</b> , trocarts	327
<b>SAROT</b> , pinces-clamps à bronches	30	<b>SMILLIE</b> , bistouris à ménisques	467
<b>SAROT</b> , porte-aiguilles	183	<b>SMILLIE</b> , écarteurs pour le genou	466
<b>SAROT</b> , porte-aiguilles tungstène TUC	197	<b>SMITH (MOD. USA)</b> , ciseaux pour pansements	133
<b>SATINSKY</b> , ciseaux vasculaires	117	<b>SMITH</b> , ciseaux pour fils	130
<b>SATTERLEE</b> , scies à amputation	384	<b>SMITH-BUIE</b> , spéculums rectaux	536
<b>SATTLER</b> , pinces musculaires	87	<b>SMITH-FERRIS</b> , pinces à griffes	65
<b>SAUERBRUCH</b> , écarteurs	260, 274	<b>SMITH-HEYWOODS</b> , pinces à éponges	236
<b>SAUERBRUCH</b> , pinces-gouges	474	<b>SMITH-PETERSEN</b> , ciseaux-burins	419
<b>SAWTELL-SCHNIDT</b> , pinces hémostatiques pour amygdales	27	<b>SMITH-PETERSEN</b> , ostéotomes	419
<b>SAWYER</b> , spéculums rectaux	534	<b>SMITH-PETERSON</b> , pinces-gouges	475
<b>SCALP-CONTOUR</b> , écarteurs autostatiques	294	<b>SMITH-POTTS</b> , ciseaux	118
<b>SCHAEDEL</b> , pinces à champs	51	<b>SMITH-POTTS</b> , ciseaux vasculaires	113, 115
<b>SCHANZ</b> , broches	503	<b>SMITH-POTTS</b> , micro-porte-aiguilles	212
<b>SCHUDE</b> , curettes tranchantes	435	<b>SMITH-POTTS</b> , micro-porte-aiguilles tungstène TUC	205
<b>SCHINDLER</b> , pinces-clamps pour le péritoine	50	<b>SMITH-POTTS</b> , pinces à dissection et à griffes	63
<b>SCHINK</b> , dermatome	176	<b>SNELLEN</b> , pinces à entropion	88
<b>SCHMID</b> , aiguilles spéciales	345	<b>SNITMAN</b> , écarteurs autostatiques	284
<b>SCHMIEDEN</b> , aiguilles à ligatures	217	Soins des pieds	568-579
<b>SCHMIEDEN-PAYR</b> , sondes conductrices	221	Sondes	310, 311
<b>SCHMIEDEN-TAYLOR</b> , ciseaux vasculaires	116	Sondes conductrices	220-222
<b>SCHNIDT-SAWTELL</b> , pinces hémostatiques pour amygdales	27	Spatules abdominales	308
<b>SCHOEMAKER</b> , ciseaux à goitre	119	Spéculums rectaux	534-536
<b>SCHOEMAKER-LOTH</b> , ciseaux à ligatures	128	<b>SPENCER</b> , ciseaux à ligatures	128
<b>SCHUHNECHT</b> , écarteurs autostatiques	289	<b>SPENCER-DELICATE</b> , ciseaux à ligatures	128
<b>SCHUKNECHT</b> , ciseaux pour fils	130	<b>SPENCER-WELLS</b> , pinces hémostatiques	14
<b>SCHULZE-BERGMANN</b> , spéculums rectaux	535	Sphinctérosopes	537-541
<b>SCHUMACHER</b> , ciseaux pour le cordon ombilical	121	<b>SPRATT</b> , curettes tranchantes	435
<b>SCHWECKENDICK-GOOD</b> , ciseaux pour les amygdales	119	<b>ST. MARKS</b> , écarteurs	275
Scie à autopsie	483-485	<b>ST. MARTIN</b> , pinces pour sutures	85
Scie à main pour appareils plâtrés	318	<b>STACKE</b> , sondes	310
Scie électrique pour appareils plâtrés	321, 322	<b>STADLER-BRAUN</b> , ciseaux à épisiotomie	121
Scies	384, 483-485	<b>STANDARD CLAR</b> , éclairateurs frontaux	368
Scies à amputation et résection	384	<b>STANDARD</b> , ciseaux à chirurgie	102
Scies à résection et amputation	384	<b>STANDARD</b> , ciseaux à gencives	137
Scies pour bagues	482	<b>STANDARD</b> , ciseaux tungstène TUC	152, 153
<b>SCUDDER</b> , pinces-clamps stomacales et pour l'intestin	523, 526	<b>STANDARD</b> , pinces à dissection	57
<b>SCUDDER</b> , pinces-clamps stomacales et pour l'intestin Atrauma	526	<b>STANDARD</b> , pinces à griffes	57
<b>SEBILEAU</b> , élévateurs	447	<b>STANDARD</b> , trocarts	327
<b>SEDILLOT</b> , rugines-raspatoires	445	<b>STEINBACH</b> , marteaux	432
<b>SEGOND</b> , pinces à hystérectomie	45	<b>STEINMANN</b> , dous	399, 497, 498
<b>SEGOND-LANDAU</b> , pinces à hystérectomie	45	<b>STEINMANN</b> , instruments pour saisir les tendons	464
<b>SELLORS-CRAFOORD</b> , pinces auriculaires	29	<b>STELLBRINK</b> , pinces-gouges	468
<b>SEMB</b> , daviens porte-os	456	<b>STERNUM</b> , pinces à fil TUC	403
<b>SEMB</b> , pinces coupantes à os	480	<b>STERNUM</b> , pinces à torsader le fil tungstène TUC	203
<b>SEMB</b> , pinces-gouges	472	Stéthoscopes	377, 378
<b>SEMB</b> , rugines-raspatoires	446	<b>STEVENS</b> , ciseaux à ténotomie	126
<b>SEMKEN</b> , pinces à dissection et à griffes	60, 61	<b>STEVENS</b> , ciseaux tungstène TUC	161
<b>SEMKEN</b> , pinces à dissection tungstène TUC	92	<b>STEVENS</b> , micro-porte-aiguilles	212
<b>SEMM</b> , écarteurs abdominaux	303	<b>STEVENS</b> , pinces à iris	80
<b>SENN-GREEN</b> , écarteurs fins	247	<b>STIEGLITZ</b> , pinces à échardes	75
<b>SENNING (SCHWED. MODELL)</b> , porte-aiguilles	183	<b>STILLE</b> , cisailles pour appareils plâtrés	320
<b>SENNING (SCHWED. MODELL)</b> , porte-aiguilles tungstène TUC	194	<b>STILLE</b> , ciseaux-burins	421
<b>SENN-MILLER</b> , écarteurs fins	250	<b>STILLE</b> , ostéotomes	421
<b>SENN-MILLER-BABY</b> , écarteurs fins	250	<b>STILLE</b> , perforateurs à main	386
Seringues	348	<b>STILLE</b> , pinces à dissection et à griffes	65
Seringues à ampoule	347	<b>STILLE</b> , pinces-clamps pour pédicules rénaux	38
<b>SEUTIN</b> , ciseaux pour pansements	134	<b>STILLE</b> , pinces-gouges	472
<b>SHORTBENT</b> , ciseaux à ligatures	129	<b>STILLE-BARRAYA</b> , pinces à griffes	65
<b>SIEBOLD</b> , ciseaux à gynécologie	107	<b>STILLE-DOYEN</b> , écarteurs	266
<b>SIMON</b> , bistouris à fistules	174	<b>STILLE-LISTON</b> , pinces coupantes à os	479
		<b>STILLE-LUER</b> , pinces-gouges	473
		<b>STILLE-MAYO</b> , ciseaux	105



	Page		Page
<b>STILLE-MAYO</b> , ciseaux tungstène TUC	154	<b>UNI OTOSKOP</b> , trousse à diagnostic	381
<b>STILLE-RUSKIN</b> , pinces-gouges	472	<b>UNIVERSAL</b> , ciseaux pour fils	130
<b>STILLE-SHERMAN</b> , perforateurs à main	385	<b>UNIVERSAL</b> , ciseaux pour pansements	132
<b>STRATTE</b> , porte-aiguilles	185	<b>UNIVERSAL</b> , ciseaux tungstène TUC	162
<b>STRATTE</b> , porte-aiguilles tungstène TUC	197	<b>UNIVERSAL</b> , perforateurs à main	389
<b>STRAUSS</b> , rectoscope	548	<b>UNIVERSAL</b> , pinces-gouges	468
<b>STRULLY</b> , ciseaux vasculaires	115	<b>UNIVERSAL</b> , trocars	327
<b>SULLIVAN (BROPHY)</b> , ciseaux fins	123	<b>US-TPYE BALFOUR</b> , écarteurs abdominaux	299
<b>SULLIVAN</b> , ciseaux à gencives	137		
Super Cut ciseaux SC	101	<b>V</b>	
Suture	180-225		
<b>SYME</b> , aiguilles à ligatures	216	<b>VACUNOPA</b> , vacuum cleaner	324
<b>T</b>		<b>VAN BUREN</b> , daviers porte-os	452
		<b>VANNAS MOD. TÖBINGEN</b> , ciseaux pour le cataracte secondaire	139
<b>TAYLOR</b> , écarteurs spinaux	250	<b>VANNAS</b> , ciseaux pour le cataracte secondaire	139
<b>TAYLOR</b> , leviers à os	398	<b>VERBRUGGE</b> , daviers porte-os	459
<b>TAYLOR</b> , marteaux-percuteurs	369	<b>VERNET-GIL</b> , écarteurs fins	249
<b>TAYLOR</b> , pinces à dissection et à griffes	61	<b>VERNIER</b> , calibres	372, 373
<b>TAYLOR-CUSHING</b> , pinces à dissection tungstène TUC	93	<b>VERRES</b> , aiguilles spéciales	345
<b>TAYLOR-SCHMIEDEN</b> , ciseaux vasculaires	116	<b>VIRCHOW</b> , couteaux à cerveaux	173
Tendeurs serre-fils	407	Vis d'ostéo-synthèse	505-512
Tensiomètre à mercure	379	<b>VISE</b> , pinces à ligatures avec plate-forme	71
<b>TERRIER</b> , pinces hémostatiques	14	<b>VOLKMANN</b> , curettes tranchantes	434, 440
<b>TERSON</b> , pinces capsulaires	83	<b>VOLKMANN</b> , écarteurs	251, 252
<b>THIERSCH</b> , couteaux à transplantation	175	<b>W</b>	
<b>THIESS</b> , marteaux	430		
<b>THOMS-ALLIS</b> , pinces pour saisir le tissu et l'intestin	518	<b>WACHENFELDT</b> , pinces pour agrafes	224
<b>THOREK</b> , ciseaux à dissection	111	<b>WAGNER</b> , ciseaux fins à chirurgie	122
<b>THORPE</b> , calibres	372	<b>WALB</b> , couteaux à autopsie	173
Tire-veines	315	<b>WALDMANN</b> , ciseaux à épisiotomie	121
<b>TOENNIS</b> , ciseaux vasculaires	116	<b>WALTER</b> , écarteurs	250
<b>TOENNIS</b> , pinces à dissection et à ligatures	36	<b>WALTER-CARMALT</b> , pinces à échardes	73
<b>TOENNIS</b> , porte-aiguilles	188	<b>WALTON</b> , ciseaux fins	124
<b>TOENNIS</b> , porte-aiguilles tungstène TUC	201	<b>WALTON</b> , écarteurs autostatiques	297
<b>TOENNIS-ADSON</b> , ciseaux vasculaires	116	<b>WALTON</b> , pinces à pansements	239
<b>TOENNIS-ADSON-DELICATE</b> , ciseaux tungstène TUC	161	<b>WALTON</b> , scies pour bagues	482
<b>TOHOKU-JAPAN</b> , pinces à champs	52	<b>WALTON-LISTON</b> , pinces coupantes à os	478
Tords-fil	223	<b>WALTON-YANKAUER</b> , canules d'aspiration	331
Tournevis	491	<b>WANGENSTEEN</b> , pinces à dissection	65
<b>TOWNLEY</b> , calibres	372	<b>WANGENSTEEN</b> , pinces à dissection tungstène TUC	94
<b>TRAVERS</b> , écarteurs autostatiques	288	<b>WANGENSTEEN</b> , porte-aiguilles	185
<b>TRELAT</b> , aiguilles à ligatures	218	<b>WANGENSTEEN</b> , porte-aiguilles tungstène TUC	197
Tréphines pour appareils plâtrés	318	<b>WANGENSTEEN-DELICATE</b> , porte-aiguilles	185
<b>TROCAR</b> , aiguilles à biopsie	344	<b>WARTENBERG</b> , instruments sensibilisées	376
Trocarts	327-330	<b>WATSON</b> , dermatome	176
<b>TROELTSCH (WILDE)</b> , pinces auriculaires	77	<b>WAUGH</b> , pinces pour saisir les tissus	67
<b>TROEMNER</b> , marteaux-percuteurs	370	<b>WEBSTER</b> , porte-aiguilles	181
Trousse à varices	312	<b>WEBSTER</b> , porte-aiguilles tungstène TUC	195
Trousses à diagnostic	380, 381	<b>WECKER</b> , ciseaux à iridectomie	138
<b>TROUTMAN (CORNEAL)</b> , pinces à iris	82	<b>WEITLANER</b> , écarteurs autostatiques	287
<b>TROUTMAN</b> , ciseaux cornéales	141	<b>WEITLANER-BABY</b> , écarteurs autostatiques	287
<b>TROUTMAN</b> , micro-porte-aiguilles	207	<b>WELLS-SPENCER</b> , pinces hémostatiques	14
<b>TROUTMAN-BARRAQUER</b> , micro-porte-aiguilles	206	<b>WERTHEIM</b> , ciseaux	106
<b>TROUTMAN-CHRIS</b> , pincettes pour casser les lames	177	<b>WERTHEIM</b> , pinces à hystérectomie	41, 42
<b>TÜBINGER MODELL</b> , écarteurs	262	<b>WERTHEIM</b> , porte-aiguilles	185
<b>TUDOR-EDWARDS</b> , pinces coupantes à os	479	<b>WERTHEIM</b> , porte-aiguilles tungstène TUC	198
<b>TUFFIER</b> , écarteurs	267	<b>WERTHEIM-CULLEN</b> , pinces à hystérectomie	44
<b>TUFFIER</b> , pinces à saisir	12	<b>WESTCOTT</b> , ciseaux à ténotomie	140
<b>TUFFIER</b> , spatules abdominales	308	<b>WESTCOTT</b> , micro-ciseaux	143
<b>TUOHY</b> , aiguilles à biopsie	344	<b>WESTERMARK</b> , pinces à tampons	232
<b>TURNBULL</b> , pinces à ongles	568	<b>WIGMORE</b> , couteaux pour appareils plâtrés	318
<b>TUTTLE-SINGLEY</b> , pinces pour saisir les tissus	66	<b>WIKSTROEM</b> , pinces à dissection et à ligatures	41
<b>U</b>		<b>WILDBERG</b> , agrafes	496
		<b>WILDE (TROELTSCH)</b> , pinces auriculaires	77
<b>UCKERMANN</b> , porte-coton	312	<b>WILLET-MARTEL</b> , pinces hémostatiques pour le cuir chevelu	12
<b>ULRICH</b> , daviers porte-os	462	<b>WILLIAMS</b> , pinces pour saisir le tissu et l'intestin	518
<b>ULRICH</b> , pinces à pansements	229	<b>WILLIGER</b> , curettes tranchantes	440
		<b>WILLIGER</b> , élévateurs	447



<b>WILLIGER</b> , marteaux	428
<b>WILLIGER</b> , rugines-raspatoirs	444
<b>WILMER</b> , ciseaux oculaires	126
<b>WISCONSIN (FOREGGER)</b> , Fibre Optic laryngoscopes	358
<b>WISCONSIN (FOREGGER)</b> , laryngoscopes	354
<b>WOLFF</b> , écarteurs pour appareils plâtrés	320
<b>WULLSTEIN MICRO</b> , canules d'aspiration	335
<b>WULLSTEIN</b> , écarteurs autostatiques	289

**Y**

<b>YANCOSKIE</b> , écarteurs pour abdominoplastie	280
<b>YANKAUER</b> , canules d'aspiration	331
<b>YANKAUER-WALTON</b> , canules d'aspiration	331
<b>YEOMAN</b> , pinces emporte-pièces à biopsie rectale	551
<b>YOUNG-HYRYNTSCHAK</b> , porte-aiguilles	189

**Z**

<b>ZAUFAL-JANSEN</b> , pinces-gouges	471
<b>ZENKER</b> , écarteurs	272
<b>ZENKER</b> , pinces à dissection et à ligatures	32
<b>ZIEGLER</b> , pinces à épiler les cils	76
<b>ZWEIFEL</b> , porte-aiguilles	187
<b>ZWEIFEL</b> , porte-aiguilles tungstène TUC	202

# Indice alfabetico

	Pagina		Pagina
<b>A</b>		<b>B</b>	
Accessori per chiodi centromidollari con gancio	490	<b>BABCOCK</b> , pinze per afferrare l'intestino	9, 519
Accessori per power drills	392	<b>BABINSKY</b> , martelli percussori	369
Accu power drill	391	<b>BABY KOCHER</b> , pinze stomacali e intestinali Atrauma	526
Accumulatore / Caricabatteria per power drills	393	<b>BABY-ADSON</b> , pinze emostatiche	25
<b>ADAMS-MAYO</b> , divaricatori autostatici	296	<b>BABY-BALFOUR</b> , divaricatori addominali	299
<b>ADISON</b> , pinza di protezione	390	<b>BABY-COLLIN</b> , divaricatori addominali	304
<b>ADLERKREUTZ</b> , pinze anatomiche e chirurgiche	65	<b>BABY-CRILE-WOOD</b> , portaghi	182
<b>ADSON</b> , cannule per aspirazione	335	<b>BABY-CRILE-WOOD</b> , portaghi tungsteno TUC	196
<b>ADSON</b> , divaricatori autostatici	290, 291	<b>BABY-DOYEN</b> , pinze stomacali e intestinali	520
<b>ADSON</b> , elevatori	449	<b>BABY-KOCHER</b> , pinze stomacali e intestinali	521, 526
<b>ADSON</b> , pinze anatomiche e chirurgiche	59, 60	<b>BABY-LEXER</b> , forbici per preparazioni	111
<b>ADSON</b> , pinze emostatiche	25	<b>BABY-METZENBAUM</b> , forbici per preparazioni	108
<b>ADSON</b> , pinze tungsteno TUC	93	<b>BABY-MIKULICZ</b> , pinze per peritoneo	49
<b>ADSON</b> , portaghi	183	<b>BABY-MIXTER</b> , pinze per preparazioni e legature	33
<b>ADSON-ANDERSON</b> , divaricatori autostatici	290	<b>BABY-OVERHOLT</b> , pinze per preparazioni e legature	23
<b>ADSON-BABY</b> , divaricatori autostatici	292	<b>BABY-POOLE</b> , cannule per aspirazione	332
<b>ADSON-BABY</b> , pinze emostatiche	25	<b>BABY-SENN-MILLER</b> , divaricatori pottilli	250
<b>ADSON-BECKMANN</b> , divaricatori autostatici	293	<b>BABY-WEITLANER</b> , divaricatori autostatici	287
<b>ADSON-BROWN</b> , pinze anatomiche e chirurgiche	60	Bacinella per soluzioni	562
<b>ADSON-MICRO</b> , pinze anatomiche e chirurgiche	59	Bacinella rotonda	559
<b>ADSON-TOENNIS</b> , forbici	116	Bacinelle	559, 561, 562
<b>ADSON-TOENNIS-DELICATE</b> , forbici tungsteno TUC	161	Bacinelle per strumenti	561
<b>ADVENTITIA</b> , micro forbici	145, 147	Bacinelle reniformi	559
Aghi di Réverdin	214	<b>BACKHAUS</b> , pinze per fissare le compresse (Fissatele)	52
Aghi per biopsia	343, 344	<b>BACON</b> , pinze-sgorbie	470
Aghi per introduzione	346	<b>BAINBRIDGE</b> , pinze emostatiche	27
Aghi per legatura	215-219	<b>BAINBRIDGE</b> , pinze stomacali e intestinali Atrauma	524
Aghi speciali	345	<b>BALFOUR US-TYPE</b> , divaricatori addominali	299
Agrafes	225	<b>BALFOUR</b> , divaricatori addominali	299, 300
Air power drill	391	<b>BALFOUR-BABY</b> , divaricatori addominali	299
<b>ALAN PARKS</b> , anoscopi	537	<b>BALL &amp; SOCKET</b> , pinze per fissare le compresse (Fissatele)	52
<b>ALDERDYCE</b> , elevatori	448	<b>BALLANTINE-HEANEY</b> , pinze per isterectomia	43
Alesatore per viti per ossa	513	<b>BALLENGER-FOERSTER</b> , pinze per spugne	237
<b>ALEXANDER</b> , periostotomi	446	<b>BARRAQUER</b> , forbici per iridectomia	138
<b>ALEXANDER</b> , scalpelli	418	<b>BARRAQUER</b> , micro-portaghi	206
Allarga gessi	319	<b>BARRAQUER</b> , pinze depilatorie	76
<b>ALLIS</b> , pinze per afferrare tessuti	9	<b>BARRAQUER</b> , pinze per la camera anteriore	85
<b>ALLIS</b> , pinze per afferrare tessuti e l'intestino	517	<b>BARRAQUER-KATZIN (COLIBRI)</b> , pinze per iride	82
<b>ALLIS-ADAIR</b> , pinze per afferrare tessuti e l'intestino	517	<b>BARRAQUER-KATZIN</b> , forbici per cornea	142
<b>ALLIS-BABY</b> , pinze per afferrare tessuti e l'intestino	517	<b>BARRAQUER-TROUTMAN</b> , micro-portaghi	206
<b>ALM</b> , divaricatori autostatici	283	<b>BARRAYA-STILLE</b> , pinze anatomiche e chirurgiche	65
<b>ALY</b> , strumenti per sensibilità	376	<b>BAUMGARTNER</b> , portaghi	184
<b>ANDERSON-ADSON</b> , divaricatori autostatici	290	<b>BECK-LUETHY</b> , portaghi tungsteno TUC	202
<b>ANDREWS-PYNCHON</b> , cannule per aspirazione	331	<b>BECKMANN</b> , divaricatori autostatici	292
Anestesia	353-363	<b>BECKMANN-ADSON</b> , divaricatori autostatici	293
Anoscopi	537-543	<b>BECKMANN-EATON</b> , divaricatori autostatici	293
<b>ANVIL</b> , tronchesine per unghie	571	<b>BEEBEE</b> , forbici per corone	130, 131
Archi per estensione	399, 400	<b>BEER</b> , pinze depilatorie	76
<b>ARLT-FISCHER</b> , pinze per iride	80	<b>BEESON</b> , allarga gessi	319
<b>ARRUGA</b> , micro-portaghi	212	Bendaggi	318-324
<b>ARRUGA</b> , pinze capsulare	83	<b>BENGOLEA</b> , pinze emostatiche	28
<b>ARRUGA</b> , portaghi	180	<b>BENSAUDE</b> , anoscopi	540
<b>ARRUGA</b> , portaghi tungsteno TUC	201	<b>BERENS</b> , pinze muscolare	88
<b>ARRUGA-KALT</b> , micro-portaghi	212	<b>BERGMANN</b> , forbici per bendaggi	132
Artroscopia	408-415	<b>BERGMANN</b> , martelli	427
Astucci per diagnostica	380, 381	<b>BERGMANN</b> , seghe per apparecchi gessati	318
Astuccio per vari	312	<b>BERKE</b> , pinze per calazio	89
<b>AUSTIN</b> , pinze per legature	71	<b>BERLINER</b> , martelli percussori	370
<b>AUSTRALIA</b> , divaricatori	283	<b>BERNHARD</b> , pinze per fissare le compresse (Fissatele)	51
<b>AUSTRALIA</b> , divaricatori per la chirurgia della mano	285	<b>BEYER</b> , pinze-sgorbie	471
<b>AYER</b> , pinze per calazio	88	Bicchieri graduati	556, 559
		<b>BILLROTH</b> , divaricatori	252
		<b>BINKHORST</b> , pinze capsulare	83

<b>BIRCHER</b> , meniscotomi	467	<b>CARDIOPHON</b> , stetoscopi	378
<b>BIRCHER-GANSKE</b> , tenaglie per ossa	453	<b>CARMALT-ROCHESTER</b> , pinze emostatiche	27
<b>BIRKETT</b> , pinze per preparazioni e legature	41	<b>CARMALT-WALTER</b> , pinze per schegge	73
<b>BISHOP-HARMAN</b> , pinze per iride	82	<b>CAROLL</b> , goniometro	373
Bisturi	165-177	<b>CAROLL</b> , strumenti per afferrare tendini	464
Bisturi per ascessi	174	<b>CARREL</b> , pinze emostatiche	14
Bisturi per fistole	174	<b>CARROLL</b> , portaghi	182
Bisturi per interventi	169-171	<b>CARROLL</b> , portaghi tungsteno TUC	194
<b>BLASCOVICS</b> , pinze muscolare	87	<b>CARTILAGE-MARTIN</b> , forbici	118
<b>BLOND</b> , anoscopi	542, 543	<b>CASTROVIEJO</b> , circolo	375
<b>BLOUNT</b> , divaricatori per il ginocchio	466	<b>CASTROVIEJO</b> , forbici per cornea	141
<b>BLOUNT</b> , elevatori per ossa	398	<b>CASTROVIEJO</b> , forbici per iridectomia	138
<b>BLUEPOWER</b> , seghea elettrica per gesso	322	<b>CASTROVIEJO</b> , micro-portaghi	210, 213
<b>BLUMENTHAL</b> , pinze-sgorbie	469	<b>CASTROVIEJO</b> , micro-portaghi tungsteno TUC	204, 205
<b>BÖHLER</b> , archi per estensione	399	<b>CASTROVIEJO</b> , pinza capsulare	83
<b>BÖHLER</b> , pinze-sgorbie	471	<b>CASTROVIEJO</b> , pinze fissatrice	84
<b>BOLEY</b> , calibratore	373	<b>CASTROVIEJO</b> , pinze per rompere la lamette	177
<b>BONACCOLTO</b> , pinze per sutura	85	<b>CASTROVIEJO</b> , pinze per sutura	85
<b>BONNEY</b> , pinze per afferrare tessuti	68	<b>CASTROVIEJO-EPKER</b> , circolo	375
<b>BONNEY</b> , pinze tungsteno TUC	94	<b>CASTROVIEJO-KALT</b> , micro-portaghi	212
<b>BOOMERANG</b> , portaghi	189	<b>CATLIN</b> , coltelli per amputazione	172
<b>BÖTTCHER</b> , forbici per tonsille	119	Cesioio per gesso	319
<b>BOYNTON</b> , portaghi	180	Cesoie per ossa	477-480
<b>BOYNTON</b> , portaghi tungsteno TUC	201	<b>CHADWICK</b> , forbici oftalmologiche	126
<b>BOYS-ALLIS</b> , pinze per afferrare tessuti e l'intestino	518	<b>CHAPUT</b> , pinze per afferrare	12
<b>BOZEMANN</b> , pinze per tamponi	233	<b>CHARRIERE</b> , seghe per amputazione	384
<b>BOZEMANN</b> , portaghi	182	<b>CHEATLE</b> , pinze per sterilizzazione	564
<b>BOZEMANN</b> , portaghi tungsteno TUC	197	<b>CHERON</b> , pinze per polipi	234
<b>BOZEMANN</b> , strumenti per legatura	223	<b>CHILDE</b> , pinze per agrafes	225
<b>BOZEMANN-DOUGLAS</b> , pinze per tamponi	233	Chiodi	492-498
<b>BRAND</b> , strumenti per afferrare tendini	464	Chiodi per ossa	492-498
<b>BRAUN-STADLER</b> , forbici per episiotomia	121	Chiodo a gancio	495
<b>BRIDGE</b> , pinze per preparazioni e legature	34	<b>CHRIS-TROUTMAN</b> , pinze per rompere le lamette	177
<b>BRODIE</b> , sonde	311	<b>CHURCH</b> , forbici	117
<b>BROPHY (SULLIVAN)</b> , forbici fine	123	<b>CLAR 55</b> , lampade frontali	368
<b>BROPHY</b> , pinze anatomiche e chirurgiche	63	<b>CLAR STANDARD</b> , lampade frontali	368
<b>BROWN</b> , pinze anatomiche e chirurgiche	64	<b>CLASSON</b> , forbici	117
<b>BROWN</b> , portaghi	183	<b>CLAUS</b> , aghi per legatura	218
<b>BROWN-ADSON</b> , pinze anatomiche e chirurgiche	60	<b>CLAUS-EICKEN</b> , aghi per legatura	219
<b>BROWNE-DENIS</b> , divaricatori addominali	301	<b>CLEVELAND</b> , cesoie per ossa	478
<b>BRUNNER</b> , aghi per legatura	216, 217	<b>CLEVELAND</b> , pinze-sgorbie	468
<b>BRUNNER</b> , divaricatori	263	<b>CLEVELAND-GARDNER</b> , cesoie per ossa	477
<b>BRUNNER</b> , pinze stomacali e intestinali	520	<b>CLOWARD HIBBS SPRATT</b> , curette taglienti	437
<b>BRUNNER</b> , sonde conduttrice	220	<b>COAKLEY</b> , trequarti	330
<b>BRUNNER-FERROZELL</b> , sonde conduttrice	222	<b>COBB</b> , curette taglienti	439
<b>BRUNS</b> , curette taglienti	434, 437	<b>COBB</b> , elevatori	449
<b>BRUNS</b> , forbici per apparecchi gessati	134	<b>COBB</b> , scalpelli	424
<b>BRYANT</b> , pinze per spugne	228	<b>COGSWELL</b> , cannule per aspirazione	336
<b>BUCK</b> , forbici per legatura	129	<b>COLBRI (BARRAQUER-KATZIN)</b> , pinze per iride	82
<b>BUCK</b> , martelli percussori	369	<b>COLLEGE-LONDON</b> , pinze per cotone	95
<b>BUJELAU</b> , trequarti	328	<b>COLLER</b> , pinze emostatiche	17
<b>BULLDOG</b> , pinze	10, 11	<b>COLLIER</b> , portaghi	180
<b>BUNNELL</b> , perforatori a mano	388	<b>COLLIN</b> , bisturi per interventi	170
<b>BUNNELL</b> , scollatendini	465	<b>COLLIN</b> , coltelli per amputazione	172
<b>BUSCH</b> , forbici ombelicale	121	<b>COLLIN</b> , dinamometri	374
<b>BYRD</b> , cannule per aspirazione	332	<b>COLLIN</b> , divaricatori addominali	304, 305
		<b>COLLIN</b> , manici per bisturi	166
<b>C</b>		<b>COLLIN</b> , martelli	429
<b>CAIRNS</b> , pinze emostatiche	22	<b>COLLIN</b> , pinze per afferrare	13
Calibratori	372, 373	<b>COLLIN</b> , pinze per agrafes	224
<b>CAMPBELL</b> , trequarti	328	<b>COLLIN</b> , pinze per polipi	234
Cannule di liposuzione e infiltrazione	339, 341, 342	<b>COLLIN-BABY</b> , divaricatori addominali	304
Cannule per aspirazione	331-337	<b>COLLIN-DUVAL</b> , pinze per afferrare tessuti	66
<b>CANNY RYALL</b> , divaricatori	279	<b>COLLIN-HARTMANN</b> , divaricatori	277
Canule per aspirazione	503	Coltelli per amputazione	172
<b>CAPLAN</b> , forbici nasale	119	Coltelli per apparecchi gessati	318
<b>CARDINALE</b> , forbici per ginecologia	107	Coltelli per autopsia	173
<b>CARDINALE</b> , forbici tungsteno TUC	155	Coltelli per cervello	173
		Coltelli per trapianti	175



	Pagina		Pagina
<b>CONE</b> , divaricatori autostatici	292	<b>DERF</b> , portaghi tungsteno TUC	195
<b>CONVERSE</b> , portaghi tungsteno TUC	195	<b>DERF-CONVERSE</b> , portaghi Dermatomo	176
<b>CONVERSE-DERF</b> , portaghi	180	<b>DESCHAMPS</b> , aghi per legatura	215
<b>COOLEY</b> , cannule per aspirazione	333	<b>DESJARDINS</b> , pinze per vie biliari	40
<b>COOLEY</b> , dilatatori per vasi	313	<b>DESMARRES</b> , divaricatori sottili	248
<b>COOPER</b> , aghi per legatura	216	<b>DESMARRES</b> , pinze per calazio Diagnostica	367-382
<b>CORNEAL (TROUTMAN)</b> , pinze per iride	82	<b>DICK</b> , pinze per anastomosi	528
<b>CORWIN</b> , pinze per ritorcere TUC	203	<b>DIEFFENBACH</b> , bisturi per ascessi	174
<b>CORWIN</b> , tenaglie TUC per fili	403	<b>DIEFFENBACH</b> , bisturi per interventi	170, 171
<b>CORYLLOS</b> , divaricatori	274	<b>DIEFFENBACH</b> , pinze bulldog	11
<b>COTTLE KAZANJIAN</b> , cesoie per ossa	477	<b>DIETRICH</b> , micro-portaghi tungsteno TUC	205
<b>COTTLE</b> , forbici nasale	120	<b>DIETRICH-HEGEMANN</b> , forbici per chirurgia vascolare	114
<b>COTTLE</b> , martelli	428	Dilatatori per vasi	72, 313, 314
<b>COTTLE</b> , pinze nasale	77	Dinamometro	374
<b>COUPLAND</b> , cannule per aspirazione	337	<b>DINGMANN</b> , pinze per afferrare cartilagine	453
<b>CRAFOORD</b> , forbici	118	<b>DIPLOMAT</b> , sfigmomanometro a mercurio	379
<b>CRAFOORD</b> , pinze per bronchi	30	<b>DISSECTION</b> , micro forbici	145, 147
<b>CRAFOORD-SELLORS</b> , pinze auricolari	29	Divaricatori	242-308
<b>CRANLE-CAPLAN</b> , pinze per marcazione	98	Divaricatori addominali	298-307
<b>CREGO</b> , elevatori per ossa	398	Divaricatori autostatici	283, 284, 287-297
<b>CRILE</b> , pinze emostatiche	17	Divaricatori ottico per endoscopi	281, 282
<b>CRILE</b> , portaghi	187	Divaricatori per il ginocchio	466
<b>CRILE-MURRAY</b> , portaghi	182	Divaricatori per la chirurgia della mano	285
<b>CRILE-RANKIN</b> , pinze emostatiche	17	Divaricatori per ramo	257
<b>CRILE-WOOD</b> , portaghi	182	Divaricatori per tessuti molli	255, 256
<b>CRILE-WOOD</b> , portaghi tungsteno TUC	196	Divaricatori sottili	242-250
<b>CRILE-WOOD-BABY</b> , portaghi	182	Divaricatori spinali	250
<b>CRILE-WOOD-BABY</b> , portaghi tungsteno TUC	196	Divaricatori universale	282
<b>CULLEN-WERTHEIM</b> , pinze per isterectomia	44	Divaricatori von illuminazione a luce fredda	281
Curette	434-441	<b>DIXON-LOVELACE</b> , pinze emostatiche	26
Curette taglienti	434-441	<b>DOUGLAS</b> , pinze depilatorie	76
<b>CUSHING</b> , divaricatori sottili	244, 248	<b>DOUGLAS</b> , trequarti	330
<b>CUSHING</b> , divaricatori spinali	250	<b>DOUGLAS-BOZEMANN</b> , pinze per tamponi	233
<b>CUSHING</b> , perforatori a mano	387	<b>DOYEN</b> , divaricatori	267
<b>CUSHING</b> , pinze anatomiche e chirurgiche	62	<b>DOYEN</b> , divaricatori addominali	302
<b>CUSHING</b> , pinze tungsteno TUC	93	<b>DOYEN</b> , forbici	106
<b>CUSHING-TAYLOR</b> , pinze tungsteno TUC	93	<b>DOYEN</b> , martelli	428
<b>CZERNY</b> , divaricatori	279	<b>DOYEN</b> , periostotomi	445
<b>CZERNY</b> , specoli rettali	534	<b>DOYEN</b> , pinze per fissare le compresse (Fissatele)	51
<b>D</b>		<b>DOYEN</b> , pinze stomacali e intestinali	520, 524
<b>DAHMEN</b> , osteotomi	425	<b>DOYEN</b> , pinze stomacali e intestinali Atrauma	524
<b>DAHMEN</b> , scalpelli	425	<b>DOYEN</b> , portaghi	180
<b>DANDY</b> , forbici	115	<b>DOYEN</b> , sonde	310
<b>DANDY</b> , pinze per il cuoio capelluto	26	<b>DOYEN-STILLE</b> , divaricatori	266
<b>DARLING</b> , divaricatori autostatici	295	<b>DUBOIS</b> , forbici per ginecologia	107
<b>DAVIDSON</b> , divaricatori	276	<b>DUEHRSSSEN</b> , pinze anatomiche e chirurgiche	64
<b>DAVIS-RAGNELL</b> , divaricatori sottili	250	<b>DUNHILL</b> , pinze emostatiche	22
<b>DE BAKEY</b> , cannule per aspirazione	331	<b>DUPLAY</b> , pinze per polipi	236
<b>DE BAKEY</b> , dilatatori per vasi	314	<b>DUPLEX-LIGHTWEIGHT/BABY</b> , stetoscopi	378
<b>DE BAKEY</b> , forbici per chirurgia vascolare	113, 116	<b>DURANTE</b> , pinze per afferrare tessuti	68
<b>DE BAKEY</b> , forbici tungsteno TUC	157	<b>DUVAL</b> , pinze per afferrare l'intestino	519
<b>DE BAKEY</b> , pinze atrauma	91	<b>DUVAL</b> , pinze per afferrare tessuti	68
<b>DE BAKEY</b> , pinze tungsteno TUC	94	<b>DUVAL-COLLIN</b> , pinze per afferrare tessuti	66
<b>DE BAKEY</b> , portaghi tungsteno TUC	192	<b>DYNAMOMETER III</b>	374
<b>DE LA ROZA</b> , aghi per legatura	217	<b>E</b>	
<b>DE MARTEL-POTTS</b> , forbici	116	<b>EASTMAN-RICHARDSON</b> , divaricatori	264
<b>DE MARTEL-WOLFSON</b> , pinze intestinali	532, 533	<b>EATON-BECKMANN</b> , divaricatori autostatici	293
<b>DE MARTEL-WOLFSON</b> , pinze per anastomosi	532, 533	<b>ECHLIN</b> , pinze-sgorbie	474
<b>DEAN</b> , forbici per gengiva	136	<b>ECONOM</b> , astucci per diagnostica	380
<b>DEAN</b> , forbici tungsteno TUC	162	<b>EICKEN</b> , trequarti	330
<b>DEAN-DELICATE</b> , forbici per gengiva	136	<b>EICKEN-CLAUS</b> , aghi per legatura	219
<b>DEAVER</b> , divaricatori	269-271	<b>EICKEN-KILLIAN</b> , cannule per aspirazione	335
<b>DEAVER</b> , forbici per chirurgia	104	<b>EISELSBERG</b> , forbici per legatura	128
<b>DEJERINE</b> , martelli percussori	370	Elevatori	447-449, 481
<b>DEMEL</b> , strumenti tendi fili	407	Elevatori per ossa	395-398
<b>DENIS-BROWNE</b> , divaricatori addominali	301		
<b>DERF</b> , portaghi	180		

<b>ELSCHNIG</b> , pinze fissatrice	84
<b>ENGEL</b> , seghe per apparecchi gessati	318
<b>ENGL. MODELL</b> , pinze per fissare le compresse (Fissatele)	51
<b>ERHARDT</b> , pinze per entropio	88
<b>ESMARCH</b> , coltelli per apparecchi gessati	318
<b>ESMARCH</b> , forbici per bendaggi	134
<b>EUFRATE-PASQUE</b> , portaghi tungsteno TUC	193
<b>EWALD</b> , pinze anatomiche e chirurgiche	60

## F

<b>FALK</b> , aghi per legatura	219
<b>FARABEUF</b> , divaricatori	278
<b>FARABEUF</b> , periostotomi	443
<b>FARABEUF</b> , tenaglie per ossa	458
<b>FARABEUF-LAMBOTTE</b> , tenaglie per ossa	458
<b>FARRELL</b> , portacotone	311
<b>FAULKNER</b> , pinze per tenere il cristallino	90
<b>FAURE</b> , pinze per isterectomia	45
<b>FAURE</b> , pinze per peritoneo	50
<b>FAVALORO</b> , forbici	115
<b>FEHLAND</b> , pinze stomacali e intestinali	527
<b>FEILCHENFELD</b> , pinze per schegge	73
<b>FEIN</b> , portacotone	312
<b>FERGUSON</b> , cannule per aspirazione	335
<b>FERGUSON</b> , forbici per chirurgia	104
<b>FERGUSON</b> , pinze per pressione progressiva	47
<b>FERGUSON</b> , tenaglie per ossa	455
<b>FERREIRA</b> , divaricatori con illuminazione a luce fredda	280
<b>FERRIS-SMITH</b> , pinze chirurgiche a denti di topo	65
<b>FERROZELL</b> , sonde conduttrice	222
<b>FERROZELL-BRUNNER</b> , sonde conduttrice	222
<b>FIBRE OPTIC</b> , Laringoscopi a luce fredda	360
Fili	499-502
<b>FINOCCHIETTO</b> , forbici	118
<b>FINOCCHIETTO</b> , pinze per peduncoli renali	37
<b>FINOCCHIETTO</b> , portaghi	185
<b>FINOCCHIETTO</b> , portaghi tungsteno TUC	197
<b>FINSEN</b> , divaricatori autostatici	283
<b>FISCHER-ARLT</b> , pinze per iride	80
Fissatele	51, 52
<b>FLAGG</b> , pinze per cotone	96
<b>FLETCHER</b> , pinze per spugne	232
<b>FOERSTER</b> , pinze per iride	81
<b>FOERSTER-BALLENGER</b> , pinze per spugne	237
<b>FOMON</b> , forbici nasale	119
<b>FOMON</b> , forbici per preparazioni	111
Forbici	102-162
Forbici addominali	106
Forbici coronaria	115
Forbici Face-lift	161
Forbici fine	122-124
Forbici micro	143-149
Forbici nasale	119, 120
Forbici oftalmologici	125-127, 138-143
Forbici ombelicale	121
Forbici per anatomia	118
Forbici per apparecchi gessati	134
Forbici per bendaggi	132-134
Forbici per capsulotomia	140
Forbici per cartilagini	118
Forbici per cataratta secondaria	139
Forbici per chirurgia	102-105, 122
Forbici per chirurgia vascolare	113-117
Forbici per cornea	141-143
Forbici per corone	130, 131
Forbici per episiotomia	118, 121
Forbici per filo metallico	130
Forbici per fistole	106

Forbici per gengiva	136, 137
Forbici per ginecologia	105-107
Forbici per gozzo	119
Forbici per incisioni	104
Forbici per iridectomia	125, 138
Forbici per legatura	128, 129
Forbici per lobectomia	118
Forbici per nervi	111
Forbici per neurochirurgia	115-117
Forbici per pelle	135
Forbici per preparazioni	108-112
Forbici per strabismo	126
Forbici per tenotomia	126, 140
Forbici per tonsille	119
Forbici per unghie	135
Forbici per unghie incarnate	135
Forbici Super-Cut SC	101
Forbici, tungsteno TUC	152-162
<b>FOREGGER (WISCONSIN) FIBRE OPTIC</b> , laringoscopi a luce fredda	358
<b>FOREGGER (WISCONSIN)</b> , laringoscopi	354
<b>FOX</b> , curette taglienti	436
<b>FOX-GOLDMAN SPEZIAL</b> , forbici per gengiva	136
<b>FOX-GOLDMAN</b> , forbici per gengiva	136
<b>FOX-GOLDMAN</b> , forbici tungsteno TUC	161
<b>FRANKENFELDT</b> , pinze per afferrare	316
<b>FRANZ</b> , divaricatori addominali	302
<b>FRAZIER</b> , cannule per aspirazione	335
<b>FRAZIER</b> , divaricatori sottili	242
<b>FREER</b> , elevatori	448
<b>FRENCH-EYE-RYDER</b> , portaghi tungsteno TUC	193
<b>FRIEDMAN</b> , pinze-sgorbie	468
<b>FRIEDRICH</b> , strumenti per legatura	223
<b>FRITSCH</b> , divaricatori	266
<b>FRYKHOLM</b> , pinze-sgorbie	474
<b>FUCHS-GILL</b> , pinze per iride	83
<b>FULTON</b> , forbici	117

## G

<b>GARETT</b> , dilatatori per vasi	313
<b>GEISSENDOERFER-OVERHOLT</b> , pinze per preparazioni e legatura	23
<b>GELPI</b> , divaricatori autostatici	294
<b>GEMINI</b> , pinze per preparazioni e legatura	35
<b>GERALD</b> , pinze anatomiche e chirurgiche	62
<b>GERSTER</b> , tenaglie per ossa	394
<b>GERSTER-LOWMAN</b> , tenaglie per ossa	394
<b>GILL</b> , pinze capsulare	83
<b>GILL-FUCHS</b> , pinze per iride	83
<b>GILL-HESS</b> , pinze per iride	82
<b>GILLIES</b> , divaricatori sottili	242
<b>GILLIES</b> , pinze chirurgiche a denti di topo	67
<b>GILLIES</b> , pinze tungsteno TUC	92
<b>GILLIES</b> , portaghi	185
<b>GILLIES</b> , portaghi tungsteno TUC	198
<b>GILLS-WELSH</b> , forbici per capsulotomia	140
<b>GIL-VERNET</b> , divaricatori sottili	249
Giravite	491
<b>GOELET</b> , divaricatori	279
<b>GOLDMAN-FOX SPEZIAL</b> , forbici per gengiva	136
<b>GOLDMAN-FOX</b> , forbici per gengiva	136
<b>GOLDMAN-FOX</b> , forbici tungsteno TUC	161
Goniometro	373
<b>GOOD</b> , forbici per tonsille	119
<b>GOOD-SCHWECKENDICK</b> , forbici per tonsille	119
<b>GORNEY</b> , forbici per preparazioni	111
<b>GOSSET</b> , divaricatori addominali	298
<b>GRADLE</b> , pinze depilatorie	76
<b>GRAEFE</b> , divaricatori sottili	243
<b>GRAEFE</b> , forbici oftalmologiche	126



	Pagina		Pagina
<b>GRAEFE</b> , pinze fissatrice	84	<b>HÖSEL</b> , portaghi	188
<b>GRAEFE</b> , pinze per iride	79	<b>HÖSEL</b> , portaghi tungsteno TUC	201
Grappas	496	<b>HOSPITAL-PROVIDENCE</b> , pinze emostatiche	16
<b>GRAY</b> , pinze per vie biliari	40	<b>HRYNTSCHAK-YOUNG</b> , portaghi boomerang	189
<b>GRAZIL</b> , forbici per chirurgia	103	<b>HUDSON</b> , perforatori a mano	387
<b>GREEN</b> , pinze fissatrice	84	<b>HUNT</b> , pinze	70
<b>GREEN-SENN</b> , divaricatori sottili	247	<b>HUNTER</b> , pinze per schegge	73
<b>GROSS-MAIER</b> , pinze per polipi	230, 231	<b>HURD</b> , aghi per legatura	218
<b>GRUENWALD (JANSEN)</b> , pinze nasale	78		
<b>GRUENWALD</b> , pinze nasale	78	<b>I</b>	
<b>GUTHRIE</b> , divaricatori sottili	246	<b>IOWA</b> , aghi speciali	345
<b>GUYON</b> , pinze per peduncoli renali	38, 39	<b>ISRAEL</b> , divaricatori	253
<b>GUYON-ARTRAUMATIC</b> , pinze per peduncoli renali	39	<b>IVES-FANSLER</b> , sfinteroscopi	538
		<b>IWANSON</b> , circolo	375
<b>H</b>			
<b>HABERER</b> , spatole addominali	308	<b>J</b>	
<b>HAJEK</b> , martelli	429	<b>JACKSON</b> , laringoscopi a luce fredda	363
<b>HALLE</b> , forbici nasale	120	<b>JACKSON</b> , pinze per medicature	78
<b>HALSEY</b> , portaghi	181	<b>JACOBI</b> , aghi per legatura	217
<b>HALSEY</b> , portaghi tungsteno TUC	195	<b>JACOBS CHUCK</b> , perforatori a mano	388
<b>HALSTED</b> , pinze emostatiche	16	<b>JACOBSON</b> , micro-portaghi	210
<b>HALSTED-MOSQUITO</b> , pinze emostatiche	15	<b>JACOBSON</b> , micro-portaghi tungsteno TUC	204
<b>HARMAN-BISHOP</b> , pinze per iride	82	<b>JACOBSON</b> , portaghi	182
<b>HARMS</b> , pinze per sutura	86	<b>JACOBSON</b> , portaghi tungsteno TUC	194
<b>HARRINGTON</b> , divaricatori	267	<b>JAMESON</b> , calibratore	372
<b>HARRISON (PYE-SMITH)</b> , pinze per sterilizzazione	564	<b>JAMESON</b> , pinze muscolare	87
<b>HARTMANN</b> , pinze emostatiche	14	<b>JAMESON</b> , portaghi	184
<b>HARTMANN</b> , pinze-sgorbie	469	<b>JANET</b> , siringhe	348
<b>HARVEY</b> , forbici per filo metallico	130	<b>JANSEN (GRUENWALD)</b> , pinze nasale	78
<b>HATFIELD</b> , curette taglienti	439	<b>JANSEN</b> , curette taglienti	440
<b>HEANEY</b> , divaricatori	277	<b>JANSEN</b> , divaricatori autostatici	284
<b>HEANEY</b> , pinze per isterectomia	43	<b>JANSEN</b> , pinze nasale	77
<b>HEANEY</b> , portaghi	184	<b>JEWELER</b> , pinze tungsteno TUC	92
<b>HEANEY-BALLANTINE</b> , pinze per isterectomia	43	<b>JOBSON-HORNE</b> , portacotone	312
<b>HEANEY-KANTER</b> , pinze per isterectomia	43	<b>JOHANSSON</b> , trequarti	329
<b>HEANEY-REZAK</b> , pinze per isterectomia	44	<b>JOHNS-HOPKINS</b> , pinze bulldog	11
<b>HEATH</b> , forbici per legatura	129	<b>JOHNS-HOPKINS</b> , pinze per posizionare	11
<b>HEATH-RICHTER</b> , pinze per agrafes	224	<b>JOHNS-HOPKINS</b> , pinze per preparazioni e legatura	32
<b>HEGAR-OLSEN</b> , portaghi	185	<b>JONES</b> , pinze per fissare le compresse (Fissatele)	51
<b>HEGAR-OLSEN</b> , portaghi tungsteno TUC	198	<b>JOSEPH</b> , divaricatori sottili	246
<b>HEGEMANN-DIETRICH</b> , forbici per chirurgia vascolare	114	<b>JOSEPH</b> , forbici per preparazioni	112
<b>HEGENBARTH</b> , pinze per agrafes	224	<b>JUDD-ALLIS</b> , pinze per afferrare tessuti e l'intestino	518
<b>HEIFETZ</b> , pinze	70		
<b>HEISS</b> , pinze emostatiche	30	<b>K</b>	
<b>HELPERICH-BIER</b> , seghe per amputazione	384	<b>KADER</b> , divaricatori	273
<b>HEMINGWAY</b> , curette taglienti	441	<b>KALT</b> , micro-portaghi	212
<b>HENAHAN</b> , uncino per dente del giudizio	481	<b>KALT</b> , micro-portaghi tungsteno TUC	205
<b>HENLEY</b> , divaricatori autostatici	288	<b>KALT-ARRUGA</b> , micro-portaghi	212
<b>HENNIG</b> , allarga gessi	319	<b>KALT-CASTROVIEJO</b> , micro-portaghi	212
<b>HERRICK</b> , pinze per peduncoli renali	39	<b>KANTER-HEANEY</b> , pinze per isterectomia	43
<b>HESS</b> , pinze per iride	81	<b>KANTROWITZ</b> , pinze per preparazioni e legature	35
<b>HESSBERG</b> , aghi per legatura	217	<b>KATZIN</b> , forbici per cornea	142
<b>HESS-GILL</b> , pinze per iride	82	<b>KATZIN-BARRAQUER</b> , forbici per cornea	142
<b>HEYMANN</b> , forbici nasale	120	<b>KATZIN-BARRAQUER</b> , pinze per iride	82
<b>HEYWOOD-SMITH</b> , pinze per spugne	236	<b>KAYE</b> , forbici Face-lift	161
<b>HIBBS</b> , osteotomi	420	<b>KELLY (RICHARDSON)</b> , divaricatori	264
<b>HIBBS</b> , scalpelli	420	<b>KELLY</b> , divaricatori	268
<b>HIRSCHMANN</b> , anoscopi	539	<b>KELLY</b> , forbici per fistole	106
<b>HOEN</b> , elevatori	448	<b>KELLY</b> , forbici tungsteno TUC	153
<b>HOESEL</b> , divaricatori	265	<b>KELLY</b> , pinze emostatiche	17
<b>HOHMANN</b> , elevatori per ossa	396, 397	<b>KELLY</b> , pinze per spugne	235
<b>HOKE</b> , osteotomi	417	<b>KELLY</b> , protoscopi	540, 541
<b>HOLINGER</b> , laringoscopi	362	<b>KELLY-RANKIN</b> , pinze emostatiche	17
<b>HOPKINS</b> , coltelli per apparecchi gessati	318	<b>KELMAN-McPHERSON</b> , pinze per sutura	85
<b>HOPKINS-JOHNS</b> , pinze bulldog	11	<b>KERN</b> , tenaglie per ossa	456
<b>HOPKINS-JOHNS</b> , pinze per posizionare	11	<b>KERSTING</b> , pinze per anastomosi	528
<b>HOPKINS-JOHNS</b> , pinze per preparazioni e legatura	32		
<b>HORNE-JOBSON</b> , portacotone	312		





	Pagina	Pagina
<b>M</b>		
<b>MAGILL</b> , pinze per cannule	360	<b>METZENBAUM-NELSON</b> , forbici per preparazioni
<b>MAIER-SIMS</b> , pinze per polipi	239	<b>MEYERDING</b> , divaricatori
Mani di piombo	482	<b>MEYERDING</b> , divaricatori autostatici
Manici per bisturi	165-167	<b>MEYERDING</b> , divaricatori sottili
Manici per cannule di liposuzione e infiltrazione	338, 340	<b>MEYERDING-MARKHAM</b> , divaricatori autostatici
Marchiatore per facelift	376	<b>MICHEL</b> , agrafes
<b>MARKHAM-MEYERDING</b> , divaricatori autostatici	294	<b>MICHEL</b> , pinze per agrafes
<b>MARKWALDER</b> , cesole per ossa	477	Micro forbici
<b>MARQUARDT</b> , pinze-sgorbie	470	Micro pinze
<b>MARTEL</b> , pinze per il cuoio capelluto	12	Micro portaghi
Martelli	427-433	<b>MICRO-ADSON</b> , pinze anatomiche e chirurgiche
Martelli percussori	369, 370	<b>MICRO-FRIEDMAN</b> , pinze-sgorbie
<b>MARTEL-WILLET</b> , pinze per il cuoio capelluto	12	<b>MICRO-MOSQUITO</b> , pinze emostatiche
<b>MARTIN</b> , divaricatori	262	Micro-portaghi con manici rotondi
<b>MARTIN</b> , pinze per afferrare cartilagine	453	<b>MICRO-RYDER</b> , portaghi tungsteno TUC
<b>MARTIN-CARTILAGE</b> , forbici	118	<b>MICROVASCULAR</b> , portaghi tungsteno TUC
<b>MARTINI</b> , curette taglienti	440	<b>MICRO-WULLSTEIN</b> , cannule per aspirazione
<b>MASS.-GENERAL-HOSPITAL (M.G.H.)</b> , portaghi	183	<b>MIDDELDORPF</b> , divaricatori
<b>MASSE-ROBIN</b> , divaricatori addominali	306	<b>MIKULICZ</b> , divaricatori
<b>MASSON</b> , portaghi	184	<b>MIKULICZ</b> , pinze per peritoneo
<b>MASSON</b> , portaghi tungsteno TUC	197	<b>MIKULICZ-BABY</b> , pinze per peritoneo
<b>MATHIEU</b> , divaricatori	278	<b>MILLER FIBRE OPTIC</b> , laringoscopi a luce fredda
<b>MATHIEU</b> , portaghi	186	<b>MILLER</b> , laringoscopi
<b>MATHIEU</b> , portaghi tungsteno TUC	199	<b>MILLER</b> , pinze per carta di articolazione
<b>MATHIEU</b> , specoli rettali	536	<b>MILLIGAN</b> , divaricatori autostatici
<b>MATHIEU-DELICATE</b> , portaghi	186	<b>MILLS</b> , forbici
<b>MATHIEU-DELICATE</b> , portaghi tungsteno TUC	199	<b>MINI</b> , lame per bisturi
<b>MATHIEU-RYDER VASCULAR</b> , portaghi tungsteno TUC	200	<b>MINI</b> , manici per bisturi
<b>MATHIEU-RYDER</b> , portaghi tungsteno TUC	200	<b>MINI-FRIEDMAN</b> , pinze-sgorbie
<b>MATSON</b> , periostotomi	446	<b>MINI-HOHMANN</b> , elevatori per ossa
<b>MAYFIELD</b> , pinze-sgorbie	470	<b>MINI-LAMBOTTE</b> , osteotomi
<b>MAYO ROBSON</b> , pinze stomacali e intestinali Atrauma	526	<b>MINI-LANGENBECK</b> , divaricatori sottili
<b>MAYO</b> , forbici	105	<b>MINI-LEXER</b> , osteotomi
<b>MAYO</b> , forbici tungsteno TUC	153	<b>MINI-LEXER</b> , scalpelli
<b>MAYO</b> , pinze per sterilizzazione	564	<b>MISKIMON</b> , divaricatori autostatici
<b>MAYO-ADAMS</b> , divaricatori autostatici	296	<b>MIXTER</b> , forbici per chirurgia
<b>MAYO-HARRINGTON</b> , forbici	105	<b>MIXTER</b> , pinze per preparazioni e legature
<b>MAYO-HEGAR</b> , portaghi	184	<b>MIXTER-BABY</b> , pinze per preparazioni e legature
<b>MAYO-HEGAR</b> , portaghi tungsteno TUC	192	<b>MIXTER-O'SHAUGNESSY</b> , pinze per preparazioni e legature
<b>MAYO-HEGAR-DELICATE</b> , portaghi	184	<b>MIXTER-OVERHOLT</b> , pinze per preparazioni e legature
<b>MAYO-HEGAR-DELICATE</b> , portaghi tungsteno TUC	192	<b>MOD. BONN</b> , forbici fine
<b>MAYO-NOBLE</b> , forbici	105	<b>MOD. BONN</b> , pinze per inde
<b>MAYO-ROBSON</b> , pinze stomacali e intestinali	521, 526	<b>MOD. TÜBINGEN</b> , divaricatori
<b>MAYO-RUSS</b> , pinze per afferrare tessuti	66	<b>MOD. TÜBINGEN</b> , pinze per sutura
<b>MAYO-STILLE</b> , forbici	105	<b>MOD. TÜBINGEN-VANNAS</b> , forbici per cataratta secondaria
<b>MAYO-STILLE</b> , forbici tungsteno TUC	154	<b>MOD. USA (SMITH)</b> , forbici per bendaggi
<b>MC GIVNEY</b> , legatori emorroidali	553	<b>MOD. USA</b> , allarga gessi
<b>MC INDOE</b> , cesole per ossa	478	<b>MOD. USA</b> , forbici ombelicale
<b>MC INDOE</b> , forbici	118	<b>MOD. USA</b> , pinze anatomiche e chirurgiche
<b>MC INDOE</b> , pinze anatomiche e chirurgiche	60	<b>MOD. WIEN</b> , strumenti per legatura
<b>MC INTOSH FIBRE OPTIC</b> , laringoscopi a luce fredda	357	<b>MODELL BONN</b> , pinze per sutura
<b>MC INTOSH</b> , laringoscopi	353	<b>MODELL TÜBINGEN</b> , divaricatori
<b>McDONALD</b> , elevatori	448	<b>MOELTGEN</b> , goniometro
<b>McDONALD</b> , pinze capsulorhexis	90	<b>MOLDESTAD</b> , divaricatori sottili
<b>McPHERSON</b> , pinze per sutura	85	<b>MOLLISON</b> , divaricatori autostatici
<b>MEAD</b> , martelli	430	<b>MOLT</b> , periostotomi
<b>MEAD</b> , pinze-sgorbie	469	<b>MOORE</b> , perforatori a mano
<b>MEEKER</b> , pinze per preparazioni e legature	25	<b>MOORFIELD</b> , pinze per sutura
<b>MENGHINI</b> , aghi per biopsia	344	<b>MORGAN</b> , anoscopi
Meniscotomi	467	<b>MORGAN</b> , luce fredda
<b>MERIAM</b> , pinze per cotone	96	<b>MORRIS</b> , divaricatori
<b>METZENBAUM</b> , forbici per preparazioni	108	<b>MOSQUITO-HALSTED</b> , pinze emostatiche
<b>METZENBAUM</b> , forbici tungsteno TUC	155, 156	<b>MOSQUITO-MICRO</b> , pinze emostatiche
<b>METZENBAUM</b> , portaghi tungsteno TUC	199	<b>MOYNIHAN</b> , pinze per isterectomia
<b>METZENBAUM-BABY</b> , forbici per preparazioni	108	<b>MYRTLE-LEAF</b> , sonde
<b>METZENBAUM-DELICATE</b> , forbici per preparazioni	110	
<b>METZENBAUM-DELICATE</b> , forbici tungsteno TUC	158-160	

## N

<b>NABATOFF</b> , astuccio per vari	312
<b>NAGER</b> , aghi per legatura	219
<b>NEFF</b> , meniscotomi	467
<b>NEGUS</b> , pinze per vie biliari	40
<b>NEIVERT</b> , portaghi	181
<b>NEIVERT</b> , portaghi tungsteno TUC	195
<b>NELATON</b> , sonde	310
<b>NELSON</b> , pinze per afferrare tessuti	66
<b>NELSON</b> , trequarti	328
<b>NELSON-METZENBAUM</b> , forbici per preparazioni	109
<b>NERVE</b> , micro forbici	147
<b>NEUMANN</b> , forbici per gengiva	137
<b>NEW ORLEANS</b> , portaghi	183
<b>NEW ORLEANS</b> , portaghi tungsteno TUC	194
<b>NIRO</b> , tenaglie fili	401
<b>NOBLE-MAYO</b> , forbici	105
<b>nopa PROFI</b> , sega per autopsia	484
<b>NORTHBENT</b> , forbici per legatura	129
<b>NOTO</b> , pinze per spugne	234
<b>NOYES</b> , forbici per indectomia	138
<b>NUSSBAUM</b> , pinze stomacali e intestinali	523

## O

<b>O'BRIAN</b> , forbici fine	124
<b>OBWEGESER</b> , divaricatori per ramo	257
<b>OBWEGESER</b> , divaricatori per tessuti molli	255, 256
<b>OCHSNER</b> , trequarti	329
<b>OCHSNER-KOCHER</b> , pinze emostatiche	20, 21
<b>O'CONNOR</b> , divaricatori sottili	243
<b>O'CONNOR-O'SULLIVAN</b> , divaricatori addominali	301
<b>OEHLER</b> , pinze tungsteno TUC	92
<b>OLIVECRONA</b> , forbici	117
<b>OLLIER</b> , divaricatori	253
<b>OLSEN-HEGAR</b> , portaghi	185
<b>OLSEN-HEGAR</b> , portaghi tungsteno TUC	198
<b>OLSEN-HEGAR-USA</b> , portaghi tungsteno TUC	198
<b>OMBREDANNE</b> , martelli	427
<b>OSCINOPA</b> , sega per autopsia	483
<b>OSCINOPA</b> , sega elettrica per gesso	321
<b>O'SHAUGNESSY-MIXTER</b> , pinze per preparazioni e legature	33
Osteotomi	417-426
<b>O'SULLIVAN-O'CONNOR</b> , divaricatori addominali	301
<b>OTOSKOP UNI</b>	381
<b>OVERHOLT</b> , pinze per preparazioni e legature	24
<b>OVERHOLT-BABY</b> , pinze per preparazioni e legature	23
<b>OVERHOLT-GEISSENDOERFER</b> , pinze per preparazioni e legature	23
<b>OVERHOLT-MIXTER</b> , pinze per preparazioni e legature	29

## P

Padelle	563
<b>PALMER</b> , chiodi	496
<b>PARAMETRIUM</b> , forbici tungsteno TUC	154
<b>PARAMETRIUM</b> , pinze per parametrium	46
<b>PARKER</b> , divaricatori	278
<b>PARKER-LANGENBECK</b> , divaricatori	278
<b>PARTSCH</b> , martelli	430
<b>PARTSCH</b> , scalpelli	418
<b>PATON</b> , micro-portaghi	212
<b>PAUFIQUE</b> , pinze per sutura	86
<b>PAYR</b> , pinze e schiacciatori	530
<b>PAYR</b> , sonde conduttrice	221
<b>PAYR-BABY</b> , pinze e schiacciatori	530
<b>PAYR-SCHMIEDEN</b> , sonde conduttrice	221
<b>PEAN</b> , pinze per afferrare	13
<b>PEAN-DELICATE</b> , pinze emostatiche	22

<b>PEAN-ROCHESTER</b> , pinze emostatiche	18, 19
Pedicure	568-579
<b>PEERS</b> , pinze per fissare le compresse (Fissatele)	52
<b>PEET</b> , pinze per schegge	75
<b>PELKMANN</b> , pinze per tamponi	235
<b>PENNINGTON</b> , pinze per afferrare	13
<b>PERCY</b> , retrattore per amputazione	463
Perforatori a mano	385-390
Periostotomi	442-446
<b>PERRY</b> , pinze per cotone	97
<b>PERTHES</b> , perforatori a mano	390
Pestoni	451
Pettine	564
<b>PHANEUF</b> , pinze per isterectomia	45
<b>PHILIPS</b> , giravite	491
<b>PIERCE</b> , trequarti	330
<b>PIFFARD</b> , curette taglienti	436
<b>PINARD</b> , stetoscopi	377
Pinza di protezione	390
Pinza per vasi	12
Pinze	57-98
Pinze anatomiche per dissezione	57-65
Pinze atrauma	91
Pinze auricolare	77
Pinze auricolari	29
Pinze bulldog	10, 11
Pinze capsulare	83
Pinze chirurgiche a denti di topo	57-65, 67, 68
Pinze depilatorie	76
Pinze e schiacciatori per intestino e stomaco	530
Pinze emostatiche	9-53
Pinze emostatiche delicate	22
Pinze emostatiche fine	15
Pinze emostatiche per tonsille	27
Pinze fissatrice	84
Pinze intestinali	532, 533
Pinze intestinali e stomacali	520-523
Pinze micro	71, 72
Pinze muscolare	87, 88
Pinze nasale	77, 78
Pinze orologio	69
Pinze per afferrare	12, 13, 316
Pinze per afferrare menisci e cartilagine	453
Pinze per afferrare l'intestino	9, 517-519
Pinze per afferrare tessuti	517, 518
Pinze per afferrare tessuti	9, 66-68, 70, 316
Pinze per agrafes	224, 225
Pinze per anastomosi	528, 529, 532, 533
Pinze per bronchi	30
Pinze per calazio	88, 89
Pinze per cannule	360
Pinze per carta di articolazione	98
Pinze per cotone	95-97
Pinze per emorroidi	47, 48
Pinze per emorroidi, atrauma	48
Pinze per entropio	88
Pinze per fissare le compresse	51, 52
Pinze per il cuoio capelluto	12, 26
Pinze per iride	79-82
Pinze per isterectomia	41-45
Pinze per la camera anteriore	85
Pinze per legature con piattaforma	71, 72
Pinze per lo strappo dello gesso	319
Pinze per marcazione	98
Pinze per medicature	78
Pinze per parametrium	46
Pinze per peduncoli renali	37-39
Pinze per peritoneo	49, 50
Pinze per polipi	229-239



	Pagina		Pagina
Pinze per posizionare	11	<b>RANKIN-KELLY</b> , pinze emostatiche	17
Pinze per preparazioni e legatura	23-25, 29, 31-36	Raspe	451
Pinze per pressione progressiva	47, 48	Recipienti cilindrici	562
Pinze per reposizione	487	Rectoscopi	544-550
Pinze per ritorcere fili TUC	203	<b>REHN</b> , coltelli per trapianti	175
Pinze per rompere le lamette	177	<b>REILL</b> , micro-portaghi	207
Pinze per schegge	73-75	<b>REINER</b> , coltelli per apparecchi gessati	318
Pinze per spugne	228-239	<b>RESANO</b> , pinze stomacali e intestinali	527
Pinze per sterilizzazione	564	Retratore per amputazione	463
Pinze per sutura	85, 86	<b>REVERDIN</b> , aghi	214
Pinze per tamponi	229-239	<b>REVERDIN</b> , spatole addominali	308
Pinze per vie biliari	37, 40	<b>REYNOLDS</b> , forbici per preparazioni	112
Pinze porta-lamelle	78	<b>REZAK-HEANEY</b> , pinze per isterectomia	44
Pinze serratubi	53	<b>RIBBON</b> , forbici oftalmologiche	127
Pinze stomacali	531	<b>RICARD</b> , divaricatori addominali	306
Pinze stomacali e intestinali atrauma	524-527	<b>RICHARDSON (KELLY)</b> , divaricatori	264
Pinze stomacali et intestinali	520-523	<b>RICHARDSON-EASTMAN</b> , divaricatori	264
Pinze taglienti per biopsia rettale	551	<b>RICHTER</b> , forbici per chirurgia	104
Pinze tungsteno TUC	92-94	<b>RICHTER-HEATH</b> , pinze per agrafes	224
Pinze-sgorbie	468-476	<b>RIGHBY</b> , divaricatori autostatici	295
Pistola lavatrice	590, 591	<b>RIRAP</b> , stetoscopi	378
Placche di carburo di tungsteno	190	<b>RISCOPE S</b> , astucci oftalmologiche	381
<b>PLESTER</b> , cannule per aspirazione	335	<b>RISCOPE S</b> , astucci oto/oftalmologiche	380
<b>PLESTER</b> , divaricatori autostatici	295	<b>ROBERTS</b> , pinze emostatiche	30
<b>POOLE</b> , cannule per aspirazione	332	<b>ROBIN-MASSÉ</b> , divaricatori addominali	306
<b>POOLE-BABY</b> , cannule per aspirazione	332	<b>ROCHESTER-CARMALT</b> , pinze emostatiche	27
Portacotone	311, 312	<b>ROCHESTER-PEAN</b> , pinze emostatiche	18, 19
Portaghi	180-213	<b>ROEDER</b> , pinze per fissare le compresse (Fissatele)	52
Portaghi micro	204-213	<b>ROETTGEN-RUSKIN</b> , pinze-sgorbie	473
Portaghi tungsteno TUC	192-205	<b>ROGGE</b> , pinze per sterilizzazione	564
Portalegature	223	<b>ROLLET</b> , divaricatori sottile	246
<b>POTTS-DE MARTEL</b> , forbici	116	<b>ROSCHKE</b> , anoscopi	537
<b>POTTS-SMITH</b> , forbici	118	<b>ROSSEGGER-KLIMA</b> , aghi per biopsia	343
<b>POTTS-SMITH</b> , forbici per chirurgia vascolare	113, 115	<b>ROTTER</b> , aghi per legatura	219
<b>POTTS-SMITH</b> , forbici tungsteno TUC	157	<b>ROUX</b> , divaricatori	277
<b>POTTS-SMITH</b> , micro-portaghi	212	<b>ROWE</b> , pinze per reposizione	487
<b>POTTS-SMITH</b> , micro-portaghi tungsteno TUC	205	Rubinetti	349
<b>POTTS-SMITH</b> , pinze anatomiche e chirurgiche	63	<b>RUDD</b> , legatori emorroidali	554
<b>POTTS-SMITH</b> , pinze tungsteno TUC	92	<b>RUMEL</b> , pinze per preparazioni e legature	31
<b>PRATT</b> , pinze per emorroidi	47	<b>RUSKIN</b> , pinze-sgorbie	471, 475
<b>PRATT</b> , sonda per fistule	311	<b>RUSKIN-LISTON</b> , cesoie per ossa	478
<b>PRATT</b> , specoli rettali	536	<b>RUSKIN-MINI</b> , pinze-sgorbie	471
<b>PRECISA</b> , sfigmomanometro	379	<b>RUSS. MOD.</b> , pinze per afferrare tessuti	68
<b>PRESBYTERIAN</b> , pinze serratubi	53	<b>RYDER-FRENCH-EYE</b> , portaghi tungsteno TUC	193
<b>PRINCE</b> , forbici per tonsille	119	<b>RYDER-LANGENBECK</b> , portaghi tungsteno TUC	202
<b>PRINCE</b> , pinze muscolare	87	<b>RYDER-MATHIEU VASCULAR</b> , portaghi tungsteno TUC	200
Protoscopi	537-543	<b>RYDER-MATHIEU</b> , portaghi tungsteno TUC	200
<b>PROVIDENCE-HOSPITAL</b> , pinze emostatiche	16	<b>RYDER-MICRO</b> , portaghi tungsteno TUC	193
Puntura	327-349		
<b>PUTTI</b> , raspe	451	<b>S</b>	
<b>PYE-SMITH (HARRISON)</b> , pinze per sterilizzazione	564	<b>SALAH</b> , aghi per biopsia	343
<b>PYNCHON-ANDREWS</b> , cannule per aspirazione	331	<b>SALENIUS</b> , meniscotomi	467
		<b>SAMII</b> , pinze	70
<b>Q</b>		<b>SANVENERO</b> , forbici per preparazioni	112
<b>QUINBY</b> , forbici per gengiva	137	<b>SAROT</b> , pinze per bronchi	30
<b>QUINKE</b> , aghi per biopsia	344	<b>SAROT</b> , portaghi	183
		<b>SAROT</b> , portaghi tungsteno TUC	197
<b>R</b>		<b>SATINSKY</b> , forbici	117
<b>RABINER</b> , martelli percussori	369	<b>SATTERLEE</b> , seghe per amputazione	384
Raccordi	349	<b>SATTLER</b> , pinze muscolare	87
<b>RADOLF</b> , pinze per unghie	482	<b>SAUERBRUCH</b> , divaricatori	256, 270
<b>RAGNELL (KILNER)</b> , forbici per preparazioni	112	<b>SAUERBRUCH</b> , pinze-sgorbie	474
<b>RAGNELL-DAVIS</b> , divaricatori sottili	250	<b>SAWTELL-SCHNIDT</b> , pinze emostatiche per tonsille	27
<b>RALK</b> , perforatori a mano	389	<b>SAWYER</b> , specoli rettali	534
<b>RALK</b> , pinze per schegge	75	<b>SCALP-CONTOUR</b> , divaricatori autostatici	294
<b>RAMPLEY</b> , pinze per spugne	238	Scalpelli	417-426
<b>RANKIN-CRILE</b> , pinze emostatiche	17	Scatole per sterilizzare aghi	560
		Scatole per strumenti	562



	Pagina		Pagina
<b>SCHAEDEL</b> , pinze per fissare le compresse (Fissatele)	51	<b>SMITH-POTTS</b> , micro-portaghi	212
<b>SCHANZ</b> , fili	503	<b>SMITH-POTTS</b> , micro-portaghi tungsteno TUC	205
<b>SCHUDE</b> , curette taglienti	435	<b>SNELLEN</b> , pinze per entropio	88
<b>SCHINDLER</b> , pinze per peritoneo	50	<b>SNITMAN</b> , divaricatori autostatici	284
<b>SCHINK</b> , dermatomo	176	Sonde	310, 311
<b>SCHMID</b> , aghi speciali	345	Sonde	310-311
<b>SCHMIEDEN</b> , aghi per legatura	217	Sonde conduttrici	220-222
<b>SCHMIEDEN-PAYR</b> , sonde conduttrici	221	Spatole addominali	308
<b>SCHMIEDEN-TAYLOR</b> , forbici	116	Spazzoli per puliere	583-589
<b>SCHNIDT-SAWTELL</b> , pinze emostatiche per tonsille	27	Specchi frontali	367
<b>SCHOEMAKER</b> , forbici per gozzo	119	Specchi rettali	534-536
<b>SCHOEMAKER-LOTH</b> , forbici per legatura	128	<b>SPENCER</b> , forbici per legatura	128
<b>SCHUHNECHT</b> , divaricatori autostatici	289	<b>SPENCER-DELICATE</b> , forbici per legatura	128
<b>SCHUKNECHT</b> , forbici per filo metallico	130	<b>SPENCER-WELLS</b> , pinze emostatiche	14
<b>SCHULZE-BERGMANN</b> , specoli rettali	535	<b>SPRATT</b> , curette taglienti	435
<b>SCHUMACHER</b> , forbici ombelicale	121	<b>ST. MARKS</b> , divaricatori	275
<b>SCHWECKENDICK-GOOD</b> , forbici per tonsille	119	<b>ST. MARTIN</b> , pinze per sutura	85
Scollatendini	465	<b>STACKE</b> , sonde	310
<b>SCUDDER</b> , pinze stomacali e intestinali	523, 526	<b>STADLER-BRAUN</b> , forbici per episiotomia	121
<b>SCUDDER</b> , pinze stomacali e intestinali Atrauma	526	<b>STANDARD</b> , forbici per chirurgia	102
<b>SEBILEAU</b> , elevatori	447	<b>STANDARD</b> , forbici per gengiva	137
<b>SEDILLOT</b> , periostotomi	445	<b>STANDARD</b> , forbici tungsteno TUC	152, 153
Sega per autopsia	483-485	<b>STANDARD</b> , pinze anatomiche per dissezione	57
Segha elettrica per gesso	321, 322	<b>STANDARD</b> , pinze chirurgiche a denti di topo	57
Seghe	384, 482-485	<b>STANDARD</b> , trequarti	327
Seghe per amputazione e resezione	384	<b>STEINBACH</b> , martelli	432
Seghe per anelli	482	<b>STEINMANN</b> , chiodi	399, 497, 498
Seghe per apparecchi gessati	318	<b>STEINMANN</b> , strumenti per afferrare tendini	464
<b>SEGOND</b> , pinze per isterectomia	45	<b>STELLBRINK</b> , pinze-sgorbie	468
<b>SEGOND-LANDAU</b> , pinze per isterectomia	45	<b>STERNUM</b> , portaghi tungsteno TUC	203
<b>SELLORS-CRAFOORD</b> , pinze auricolari	29	<b>STERNUM</b> , tenaglie TUC per fili	403
<b>SEMB</b> , cesoie per ossa	480	Stetoscopi	377, 378
<b>SEMB</b> , periostotomi	446	<b>STEVENS</b> , forbici per tenotomia	126
<b>SEMB</b> , pinze-sgorbie	472	<b>STEVENS</b> , forbici tungsteno TUC	161
<b>SEMB</b> , tenaglie per ossa	456	<b>STEVENS</b> , micro-portaghi	212
<b>SEMKEN</b> , pinze anatomiche e chirurgiche	60, 61	<b>STEVENS</b> , pinze per inide	80
<b>SEMKEN</b> , pinze tungsteno TUC	92	<b>STIEGLITZ</b> , pinze per schegge	75
<b>SEMM</b> , divaricatori addominali	303	<b>STILLE</b> , cesoio per gesso	320
<b>SENN-GREEN</b> , divaricatori sottili	247	<b>STILLE</b> , osteotomi	421
<b>SENNING (SCHWED. MODELL)</b> , portaghi	183	<b>STILLE</b> , perforatori a mano	386
<b>SENNING (SCHWED. MODELL)</b> , portaghi tungsteno TUC	194	<b>STILLE</b> , pinze anatomiche e chirurgiche	65
<b>SENN-MILLER</b> , divaricatori sottili	250	<b>STILLE</b> , pinze per peduncoli renali	38
<b>SENN-MILLER-BABY</b> , divaricatori sottili	250	<b>STILLE</b> , pinze-sgorbie	472
<b>SEUTIN</b> , forbici per bendaggi	134	<b>STILLE</b> , scalpelli	421
Sfigmomanometro a mercurio	379	<b>STILLE-BARRAYA</b> , pinze chirurgiche a denti di topo	65
Sfinteroscopi	537-541	<b>STILLE-DOYEN</b> , divaricatori	266
<b>SHORTBENT</b> , forbici per legatura	129	<b>STILLE-LISTON</b> , cesoie per ossa	479
<b>SIEBOLD</b> , forbici per ginecologia	107	<b>STILLE-LUER</b> , pinze-sgorbie	473
<b>SIMON</b> , bisturi per fistole	174	<b>STILLE-MAYO</b> , forbici	105
<b>SIMON</b> , divaricatori	262	<b>STILLE-MAYO</b> , forbici tungsteno TUC	154
<b>SIMS</b> , forbici per ginecologia	107	<b>STILLE-RUSKIN</b> , pinze-sgorbie	472
<b>SIMS</b> , forbici tungsteno TUC	155	<b>STILLE-SHERMAN</b> , perforatori a mano	385
<b>SIMS</b> , specoli rettali	534	<b>STRATTE</b> , portaghi	185
<b>SIMS-MAIER</b> , pinze per polipi	239	<b>STRATTE</b> , portaghi tungsteno TUC	197
<b>SINGLEY-TUTTLE</b> , pinze per afferrare tessuti	66	<b>STRAUSS</b> , retoscopi	548
<b>SINUSCOPY</b> , trequarti	327	<b>STRULLY</b> , forbici	115
Siringhe	348	Strumenti per afferrare tendini	464
Siringhe fiali	347	Strumenti per chiodi Küntscher	488, 489
<b>SMILLIE</b> , divaricatori per il ginocchio	466	Strumenti per misurare	371-375
<b>SMILLIE</b> , meniscotomi	467	Strumenti per nodi	223
<b>SMITH (MOD. USA)</b> , forbici per bendaggi	133	Strumenti per sensibilità	376
<b>SMITH</b> , forbici per filo metallico	130	Strumenti tendi fili	407
<b>SMITH-BUIE</b> , specoli rettali	536	<b>SULLIVAN (BROPHY)</b> , forbici fine	123
<b>SMITH-HEYWOOD</b> , pinze per spugne	236	<b>SULLIVAN</b> , forbici per gengiva	137
<b>SMITH-PETERSEN</b> , osteotomi	419	Super Cut forbici SC	101
<b>SMITH-PETERSEN</b> , scalpelli	419	Sutura	180-225
<b>SMITH-PETERSON</b> , pinze-sgorbie	475	<b>SYME</b> , aghi per legatura	216
<b>SMITH-POTTS</b> , forbici	118		
<b>SMITH-POTTS</b> , forbici per chirurgia vascolari	113, 115		

	Pagina		Pagina
<b>T</b>		<b>Vassoio</b>	561
<b>TAYLOR</b> , divaricatori spinali	250	<b>VERBRUGGE</b> , tenaglie per ossa	459
<b>TAYLOR</b> , elevatori per ossa	398	<b>VERNET-GIL</b> , divaricatori sottili	249
<b>TAYLOR</b> , martelli percussori	369	<b>VERNIER</b> , calibratore	372, 373
<b>TAYLOR</b> , pinze anatomiche e chirurgiche	61	<b>VERRES</b> , aghi speciali	345
<b>TAYLOR-CUSHING</b> , pinze tungsteno TUC	93	<b>VIRCHOW</b> , coltelli per cervello	173
<b>TAYLOR-SCHMIEDEN</b> , forbici	116	<b>WISE</b> , pinze per legature con piattaforma	71
Tenaglie fili	401-403, 405, 406	Viti per ossa	505-512
Tenaglie per ossa	394, 452, 454-462	<b>VOLKMANN</b> , curette taglienti	434, 440
Tenaglie piatte	404	<b>VOLKMANN</b> , divaricatori	251, 252
<b>TERRIER</b> , pinze emostatiche	14	<b>W</b>	
<b>TERSON</b> , pinze per iride	83	<b>WACHENFELD</b> , pinze per agrafes	224
<b>THIERSCH</b> , coltelli per trapianti	175	<b>WAGNER</b> , forbici fine	122
<b>THIESS</b> , martelli	430	<b>WALB</b> , coltelli per autopsia	173
<b>THOMS-ALLIS</b> , pinze per afferrare tessuti e l'intestino	518	<b>WALDMANN</b> , forbici per episiotomia	121
<b>THOREK</b> , forbici per preparazioni	111	<b>WALTER</b> , divaricatori	250
<b>THORPE</b> , calibratore	372	<b>WALTER-CARMALT</b> , pinze per schegge	73
Tiravene	315	<b>WALTON</b> , divaricatori autostatici	297
<b>TOENNIS</b> , forbici	116	<b>WALTON</b> , forbici	124
<b>TOENNIS</b> , pinze per preparazioni e legature	36	<b>WALTON</b> , pinze per polipi	239
<b>TOENNIS</b> , portaghi	188	<b>WALTON</b> , seghe per anelli	482
<b>TOENNIS</b> , portaghi tungsteno TUC	201	<b>WALTON-LISTON</b> , cesoie per ossa	478
<b>TOENNIS-ADSON</b> , forbici	116	<b>WALTON-YANKAUER</b> , cannule per aspirazione	331
<b>TOENNIS-ADSON-DELICATE</b> , forbici tungsteno TUC	161	<b>WANGENSTEEN</b> , pinze anatomiche e chirurgiche	65
<b>TOHOKU-JAPAN</b> , pinze per fissare le compresse (Fissatele)	52	<b>WANGENSTEEN</b> , pinze tungsteno TUC	94
Torcifilo	223	<b>WANGENSTEEN</b> , portaghi	185
<b>TOWNLEY</b> , calibratore	372	<b>WANGENSTEEN</b> , portaghi tungsteno TUC	197
<b>TRAVERS</b> , divaricatori autostatici	288	<b>WANGENSTEEN-DELICATE</b> , portaghi	185
Trefina per apparecchi gessati	318	<b>WARTENBERG</b> , strumenti sensibilità	376
<b>TRELAT</b> , aghi per legatura	218	<b>WATSON</b> , dermatomo	176
Trequarti	327-330	<b>WAUGH</b> , pinze per afferrare tessuti	67
<b>TROCAR</b> , aghi per biopsia	344	<b>WEBSTER</b> , portaghi	181
<b>TROELTSCH (WILDE)</b> , pinze auricolare	77	<b>WEBSTER</b> , portaghi tungsteno TUC	195
<b>TROEMNER</b> , martelli percussori	370	<b>WECKER</b> , forbici per iridectomia	138
Tronchesine per unghie	568-570	<b>WEITLANER</b> , divaricatori autostatici	287
<b>TROUTMAN (CORNEAL)</b> , pinze per iride	82	<b>WEITLANER-BABY</b> , divaricatori autostatici	287
<b>TROUTMAN</b> , forbici per cornea	141	<b>WELLS-SPENCER</b> , pinze emostatiche	14
<b>TROUTMAN</b> , micro-portaghi	207	<b>WERTHEIM</b> , forbici	106
<b>TROUTMAN-BARRAQUER</b> , micro-portaghi	206	<b>WERTHEIM</b> , pinze per isterectomia	41, 42
<b>TROUTMAN-CHRIS</b> , pinze per rompere le lamette	177	<b>WERTHEIM</b> , portaghi	185
<b>TÜBINGER MODELL</b> , divaricatori	262	<b>WERTHEIM</b> , portaghi tungsteno TUC	198
<b>TÜBINGER MODELL</b> , divaricatori autostatici	296	<b>WERTHEIM-CULLEN</b> , pinze per isterectomia	44
<b>TUDOR-EDWARDS</b> , cesoie per ossa	479	<b>WESTCOTT</b> , forbici per tenotomia	140
<b>TUFFIER</b> , divaricatori	267	<b>WESTCOTT</b> , micro forbici	143
<b>TUFFIER</b> , pinze per afferrare	12	<b>WESTERMARK</b> , pinze per spugne	232
<b>TUFFIER</b> , spatole addominali	308	<b>WIGMORE</b> , coltelli per apparecchi gessati	318
<b>TUOHY</b> , aghi per biopsia	344	<b>WIKSTROEM</b> , pinze per preparazioni e legatura	41
<b>TURNBULL</b> , tronchesine per unghie	568	<b>WILDBERG</b> , grappas	496
<b>TUTTLE-SINGLEY</b> , pinze per afferrare tessuti	66	<b>WILDE (TROELTSCH)</b> , pinze auricolare	77
<b>U</b>		<b>WILLET-MARTEL</b> , pinze per il cuoio capelluto	12
<b>UCKERMANN</b> , portacotone	312	<b>WILLIAMS</b> , pinze per afferrare tessuti e l'intestino	518
<b>ULRICH</b> , pinze per polipi	229	<b>WILLIGER</b> , curette taglienti	440
<b>ULRICH</b> , tenaglie per ossa	462	<b>WILLIGER</b> , elevatori	447
<b>UNIVERSAL</b> , forbici per bendaggi	132	<b>WILLIGER</b> , martelli	428
<b>UNIVERSAL</b> , forbici per filo metallico	130	<b>WILLIGER</b> , periostotomi	444
<b>UNIVERSAL</b> , forbici tungsteno TUC	162	<b>WILMER</b> , forbici oftalmologiche	126
<b>UNIVERSAL</b> , perforatori a mano	389	<b>WISCONSIN (FOREGGER) FIBRE OPTIC</b> , laringoscopi a luce fredda	358
<b>UNIVERSAL</b> , pinze-sgorbie	468	<b>WISCONSIN (FOREGGER)</b> , laringoscopi	354
<b>UNIVERSAL</b> , trequarti	327	<b>WOLFF</b> , pinze per lo strappo dello gesso	320
<b>V</b>		<b>WULLSTEIN MICRO</b> , cannule per aspirazione	335
<b>VACUNOPA</b> , vacuum cleaner	324	<b>WULLSTEIN</b> , divaricatori autostatici	289
<b>VAN BUREN</b> , tenaglie per ossa	452	<b>Y</b>	
<b>VANNAS</b> , forbici per cataratta secondaria	139	<b>YANCOSKIE</b> , divaricatori abdominoplastia	280
<b>VANNAS-MOD. TÜBINGEN</b> , forbici per cataratta secondaria	139	<b>YANKAUER</b> , cannule per aspirazione	331
		<b>YANKAUER-WALTON</b> , cannule per aspirazione	331

**YEOMAN**, pinze tagliente per biopsia rettale

551

**YOUNG-HRYNTSCHAK**, portaghi boomerang

189

**Z**

**ZAUFAL-JANSEN**, pinze-sgorbie

471

**ZENKER**, divaricatori

272

**ZENKER**, pinze per preparazioni e legature

32

**ZIEGLER**, pinze depilatorie

76

**ZWEIFEL**, portaghi

187

**ZWEIFEL**, portaghi tungsteno TUC

202

