



Urology Hysteroscopy

HERMANN
MEDIZINTECHNIK

**Modular system
for easy handling
in Urology and
Hysteroscopy**

Urology Hysteroscopy



Contents

Urology

Telescopes and Cases 4
 Cold light cables and adapters 5
 Instruments for
 Cystoscopy / Urethroscopy 6-12
 Instruments for Lithotripsy 13-15
 Instruments for
 Laser-Cystoscopy **NEW** 16-17
 Instruments for
 Laser-Resectoscopy **NEW** 17
 Instruments for Resectoscopy 18-23
 Instruments for
 Resectoscopy Slim Version 24-25
 Instruments for
 Pediatric-Resectoscopy 26-28
 Instruments for Urethrotomy 29-33
 Instruments for Nephroscopy 34-36
 Instruments for
 Uretero-Renoscapy 37
 Accessories 38-40

Hysteroscopy

Hysteroscopes 42
 Diagnostic Sheaths 43-44
 Operating Sheaths 45-50
 Instruments
 for Resectoscopy 49-52
 Ringapplicator 53
 Uterus Manipulator 54
 Instruments 55-57
 Hystro-Insufflator 58



For more than 45 years:

Quality and Safety
 (ISO 9001:2000 EN ISO 13485:2003;
 Annex II, section 3 of the directive
 93/42/EEC)

Know How and Innovation
 Technology and Precision
 Service and Flexibility

Our Products:

Instruments for MIS
 (Laparoscopy, Arthroscopy, Urology)

Endoscopy units

Electro surgery and accessories

Plastic surgery

Titanium-implant-systems for maxillo
 facial as well as hand- and radius
 surgery and mandibular reconstruction

Scissors and Micro-Scissors,
 also with TC-inserts or "super cut"

Instruments for general surgery

Telescopes



Telescope

autoclavable, wide angle
Ø 4 mm, 302 mm

0°	H82-430-000
12°	H82-430-012
30°	H82-430-030
70°	H82-430-070

Ø 2,7 mm, 302 mm

0°	H82-027-000
12°	H82-027-012
30°	H82-027-030
70°	H82-027-070

Ø 2,7 mm, 187.5 mm

0°	H82-187-000
30°	H82-187-030
70°	H82-187-070

Ø 2,0 mm, 187.5 mm

0°	H82-020-000
----	--------------------

Further sizes on request !

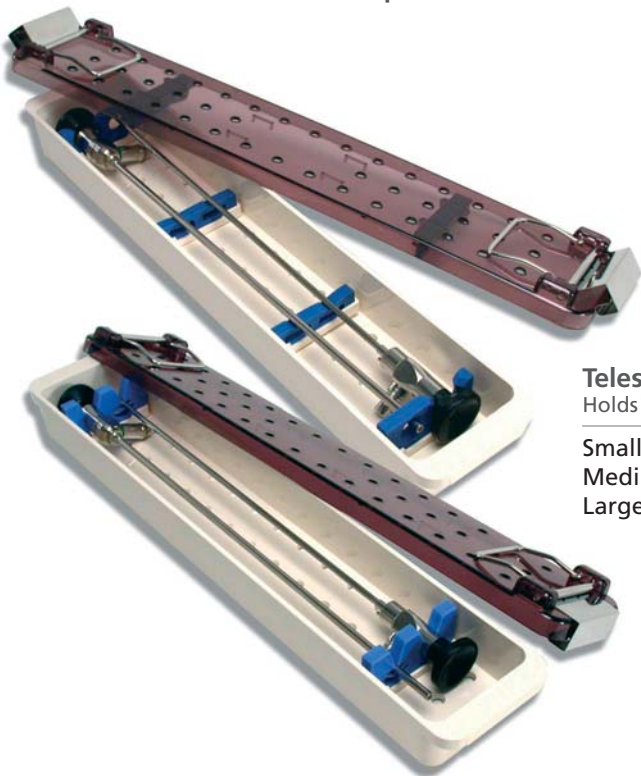

Telescope Cases

Holds 2 scopes 1 to 10 mm

Small double scope case,	27.1 x 7 x 3.5 cm	H188-99001
Medium double scope case,	39.4 x 7 x 3.5 cm	H188-99002
Large double scope case,	45.7 x 7 x 3.5 cm	H188-99003

Cold light cable

glass fibre with metal coil
resistant to crushing and
bending, STORZ-connections

Ø 3,5 mm

180 cm	H91-180-035
230 cm	H91-230-035
300 cm	H91-300-035

Ø 4,8 mm

180 cm	H91-180-045
230 cm	H91-230-045
300 cm	H91-300-045

Interchangeable adapters ensure, that
the light sources can be operated with all
types of endoscopes.
If not stated differently we will supply
fitting to Storz connection.



Light guide adapters

Instrument side

Adapter Storz / Winter / Olympus / B. Braun	H91-100-001
Adapter HSW / Wolf / Richards / Dyonics	H91-100-002
Adapter ACMI / British Standard / Stryker	H91-100-003

Projector side

Adapter Storz	H91-100-010
Adapter Wolf / Richards	H91-100-020
Adapter Olympus	H91-100-030
Adapter ACMI / British Standard / Stryker	H91-100-050

Instruments for Cystoscopy / Urethroscopy

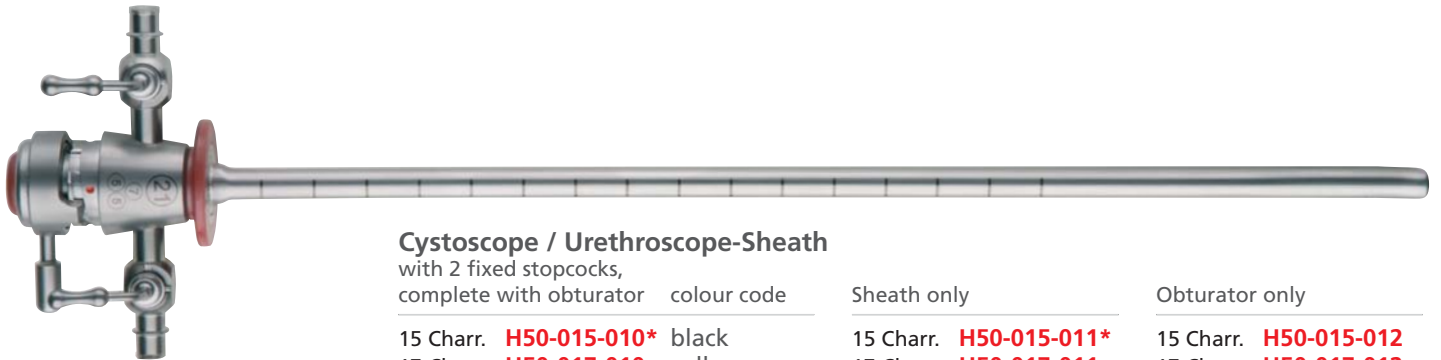

Cystoscope / Urethroscope-Sheath

with 2 fixed stopcocks,
complete with obturator

	colour code
15 Charr. H50-015-010*	black
17 Charr. H50-017-010	yellow
19 Charr. H50-019-010	green
21 Charr. H50-021-010	red
23 Charr. H50-023-010	blue
25 Charr. H50-025-010	white

Sheath only

15 Charr. H50-015-011*
17 Charr. H50-017-011
19 Charr. H50-019-011
21 Charr. H50-021-011
23 Charr. H50-023-011
25 Charr. H50-025-011

Obturator only

15 Charr. H50-015-012
17 Charr. H50-017-012
19 Charr. H50-019-012
21 Charr. H50-021-012
23 Charr. H50-023-012
25 Charr. H50-025-012

*with 5 Charr. instrument channel

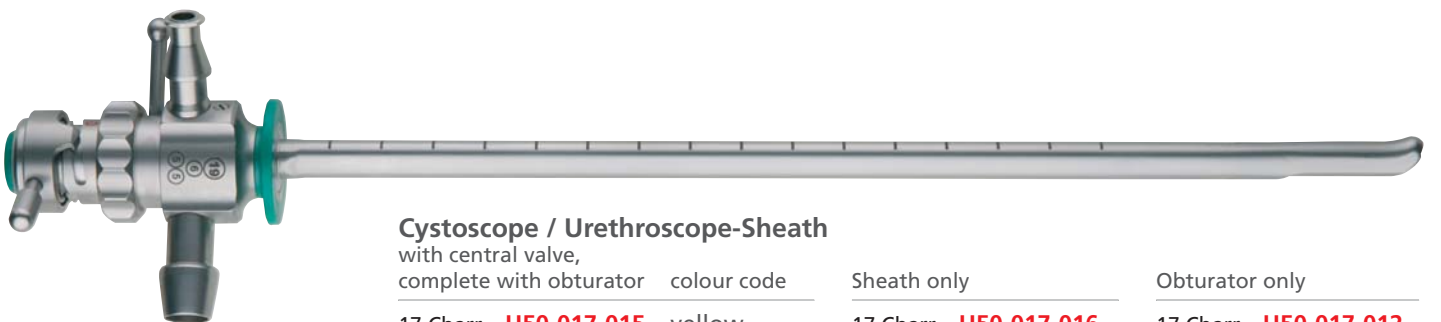

Cystoscope / Urethroscope-Sheath

with central valve,
complete with obturator

	colour code
17 Charr. H50-017-015	yellow
19 Charr. H50-019-015	green
21 Charr. H50-021-015	red
23 Charr. H50-023-015	blue
25 Charr. H50-025-015	white

Sheath only

17 Charr. H50-017-016
19 Charr. H50-019-016
21 Charr. H50-021-016
23 Charr. H50-023-016
25 Charr. H50-025-016

Obturator only

17 Charr. H50-017-012
19 Charr. H50-019-012
21 Charr. H50-021-012
23 Charr. H50-023-012
25 Charr. H50-025-012

**Instruments for
Cystoscopy / Urethroscopy**



Obturator

for Cystoscope /
Urethroscope sheath

colour code

15 Charr.	H50-015-012	black
17 Charr.	H50-017-012	yellow
19 Charr.	H50-019-012	green
21 Charr.	H50-021-012	red
23 Charr.	H50-023-012	blue
25 Charr.	H50-025-012	white

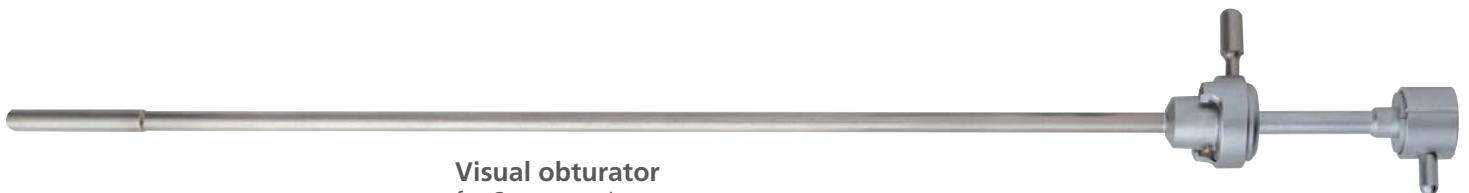

Visual obturator

for Cystoscope /
Urethroscope sheath

colour code

17 Charr.	H50-017-017	yellow
19 Charr.	H50-019-017	green
21 Charr.	H50-021-017	red
23 Charr.	H50-023-017	blue
25 Charr.	H50-025-017	white

Cystoscope-Adapter

for use with all Cystoscope-/
Urethroscope sheaths for the
female urethra

H50-400-000



Instruments for Cystoscopy / Urethroscopy

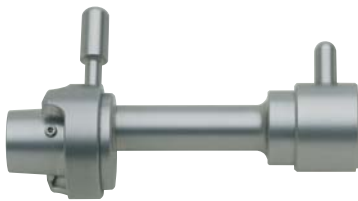

Telescope bridge
(Diagnostic)

H50-050-000



Telescope bridge
with 1 instrument channel, 12 Charr.

H50-050-001

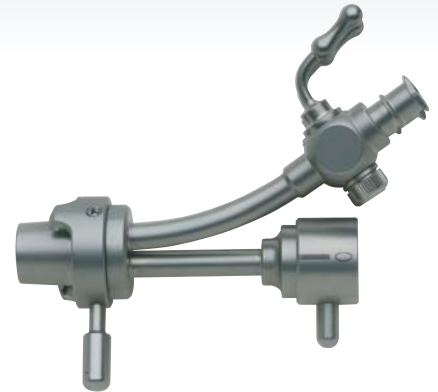

Telescope bridge
with 2 instrument channels, 12 Charr.

H50-050-002

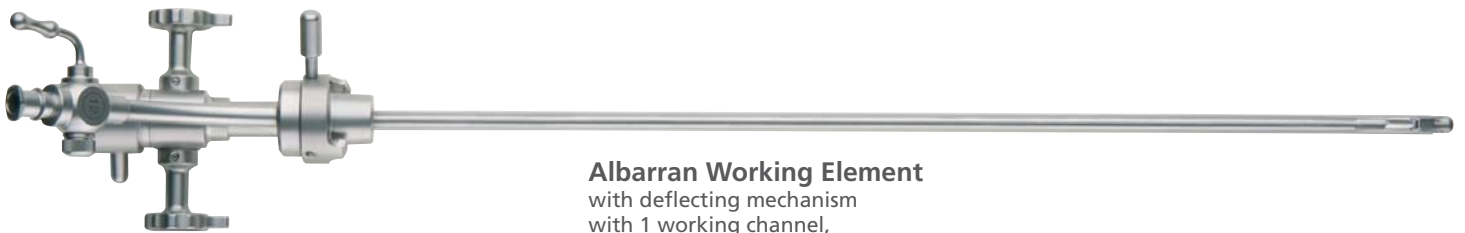

Albarran Working Element
with deflecting mechanism
with 1 working channel,
12 Charr., with ratchet

H50-060-012

Rod for Albarran

H50-061-011

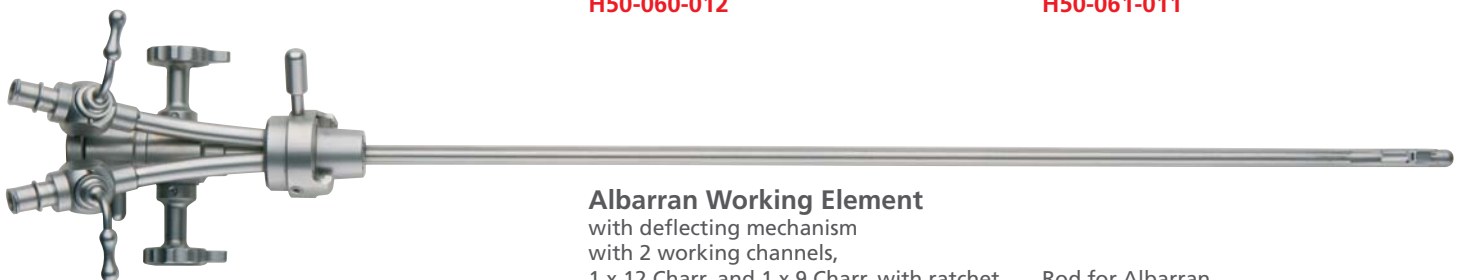

Albarran Working Element
with deflecting mechanism
with 2 working channels,
1 x 12 Charr. and 1 x 9 Charr. with ratchet

H50-060-013

Rod for Albarran

H50-061-011

Cystoscope Sheath	Catheter capacities Albarran Working Element	Catheter capacities Telescope bridge 2-Channels	Catheter capacities Telescope bridge 1-Channel	Colour Code
17 Charr.	1 x 5 Charr. 2 x 4 Charr.	1 x 5 Charr. 2 x 4 Charr.	1 x 5 Charr.	Yellow
19 Charr.	1 x 6 Charr. 2 x 4 Charr.	2 x 5 Charr. 1 x 6 Charr.	1 x 6 Charr.	Green
21 Charr.	1 x 7 Charr. 2 x 5 Charr.	2 x 6 Charr. 1 x 7 Charr.	1 x 7 Charr.	Red
23 Charr.	1 x 9 Charr. 2 x 6 Charr.	1 x 10 Charr. 2 x 7 Charr.	1 x 10 Charr.	Blue
25 Charr.	1 x 12 Charr. 2 x 8 Charr.	1 x 12 Charr. 2 x 8 Charr.	1 x 12 Charr.	White

**Instruments for
Cystoscopy / Urethroscopy**

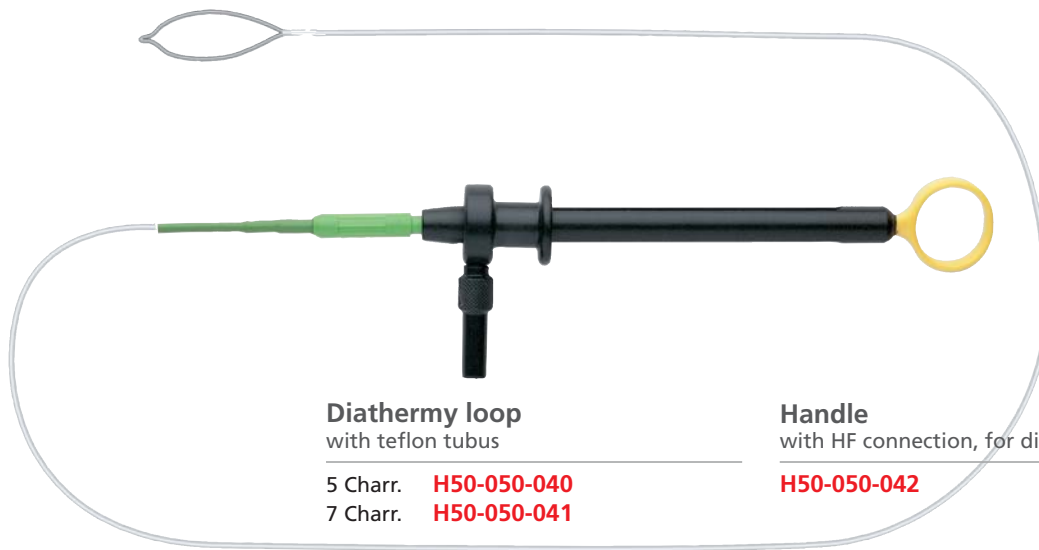

Diathermy loop
with teflon tubus

5 Charr. **H50-050-040**
7 Charr. **H50-050-041**

Handle

with HF connection, for diathermy loop

H50-050-042

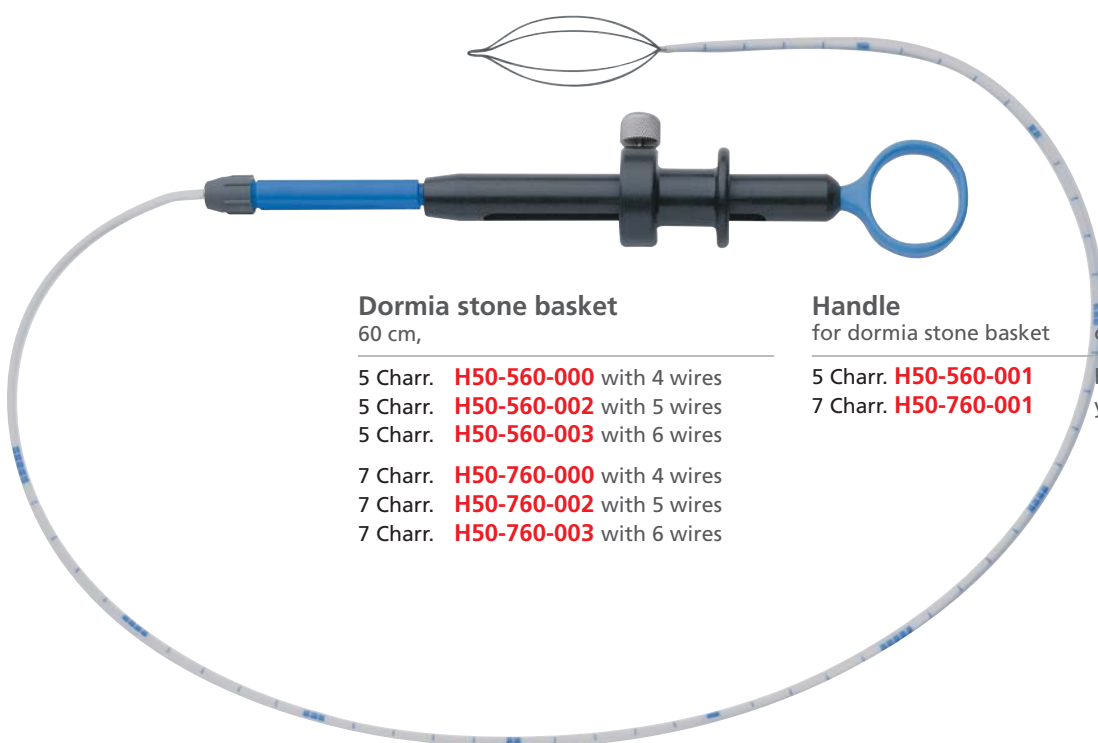

Dormia stone basket
60 cm,

5 Charr. **H50-560-000** with 4 wires
5 Charr. **H50-560-002** with 5 wires
5 Charr. **H50-560-003** with 6 wires
7 Charr. **H50-760-000** with 4 wires
7 Charr. **H50-760-002** with 5 wires
7 Charr. **H50-760-003** with 6 wires

Handle

for dormia stone basket

5 Charr. **H50-560-001**
7 Charr. **H50-760-001**

colour code

blue
yellow

Instruments for Cystoscopy / Urethroscopy



Flexible button electrode
with 2 mm HF-connection

working length 45 cm

- 3 Charr. **H50-351-000**
- 4 Charr. **H50-451-000**
- 5 Charr. **H50-551-000**
- 6 Charr. **H50-651-000**
- 7 Charr. **H50-751-000**
- 8 Charr. **H50-851-000**
- 9 Charr. **H50-951-000**
- 10 Charr. **H50-051-000**

working length 65 cm

- 3 Charr. **H50-352-000**
- 4 Charr. **H50-452-000**
- 5 Charr. **H50-552-000**
- 6 Charr. **H50-652-000**
- 7 Charr. **H50-752-000**
- 8 Charr. **H50-852-000**
- 9 Charr. **H50-952-000**
- 10 Charr. **H50-052-000**



Flexible needle electrode
with 2 mm HF-connection

working length 45 cm

- 3 Charr. **H50-351-001**
- 5 Charr. **H50-551-001**
- 7 Charr. **H50-751-001**

working length 65 cm

- 3 Charr. **H50-352-001**
- 5 Charr. **H50-552-001**
- 7 Charr. **H50-752-001**



Flexible loop electrode
with 2 mm HF-connection

working length 45 cm

- 5 Charr. **H50-551-002**
- 7 Charr. **H50-751-002**
- 9 Charr. **H50-951-002**

working length 65 cm

- 5 Charr. **H50-552-002**
- 7 Charr. **H50-752-002**
- 9 Charr. **H50-952-002**

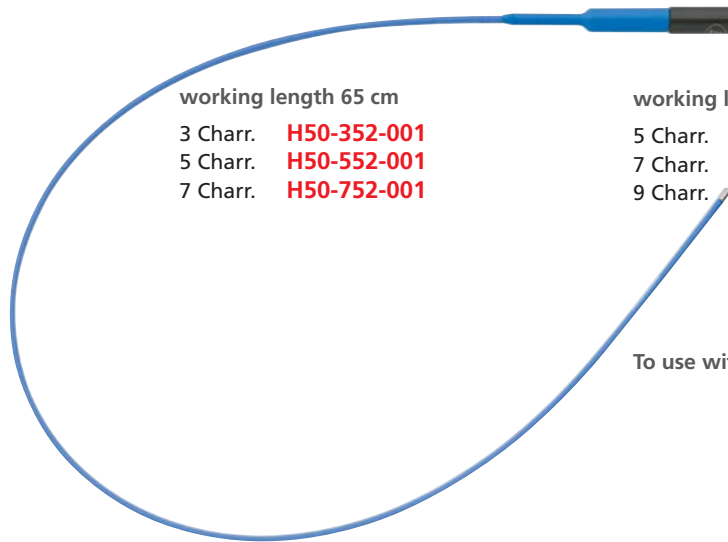

To use with HF-cables, page 20



Flexible Injection cannula

with Luer connector,
Needle \varnothing 0.7 x 10 mm,
for working channels from \varnothing 2.0 mm,
working length 50 cm

H50-150-010

**Instruments for
Cystoscopy / Urethroscopy**

Scissors

40 cm

with flexible shaft

- 3 Charr. **H50-003-010**
- 5 Charr. **H50-005-010**
- 7 Charr. **H50-007-010**
- 9 Charr. **H50-009-010**

with semi-rigid shaft

- 3 Charr. **H50-003-015**
- 5 Charr. **H50-005-015**
- 7 Charr. **H50-007-015**
- 9 Charr. **H50-009-015**

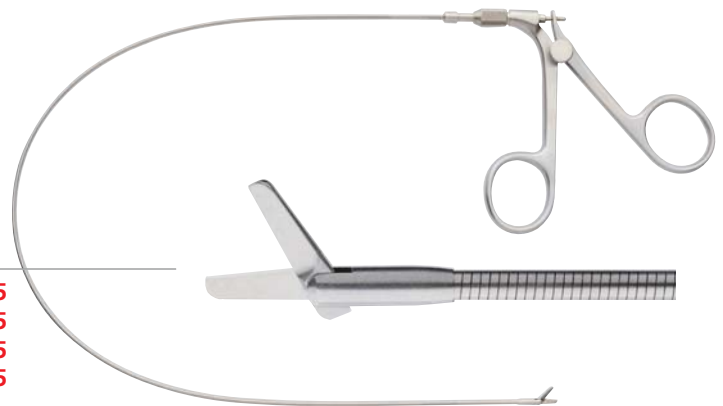

Biopsy forceps

40 cm

with flexible shaft

- 3 Charr. **H50-003-011**
- 5 Charr. **H50-005-011**
- 7 Charr. **H50-007-011**
- 9 Charr. **H50-009-011**

with semi-rigid shaft

- 3 Charr. **H50-003-016**
- 5 Charr. **H50-005-016**
- 7 Charr. **H50-007-016**
- 9 Charr. **H50-009-016**



Biopsy forceps

serrated, 40 cm

with flexible shaft

- 3 Charr. **H50-003-013**
- 5 Charr. **H50-005-013**
- 7 Charr. **H50-007-013**
- 9 Charr. **H50-009-013**

with semi-rigid shaft

- 3 Charr. **H50-003-018**
- 5 Charr. **H50-005-018**
- 7 Charr. **H50-007-018**
- 9 Charr. **H50-009-018**



Forceps

for removal of foreign bodies,

40 cm

with flexible shaft

- 3 Charr. **H50-003-012**
- 5 Charr. **H50-005-012**
- 7 Charr. **H50-007-012**
- 9 Charr. **H50-009-012**

with semi-rigid shaft

- 3 Charr. **H50-003-017**
- 5 Charr. **H50-005-017**
- 7 Charr. **H50-007-017**
- 9 Charr. **H50-009-017**



Instruments for Cystoscopy / Urethroscopy

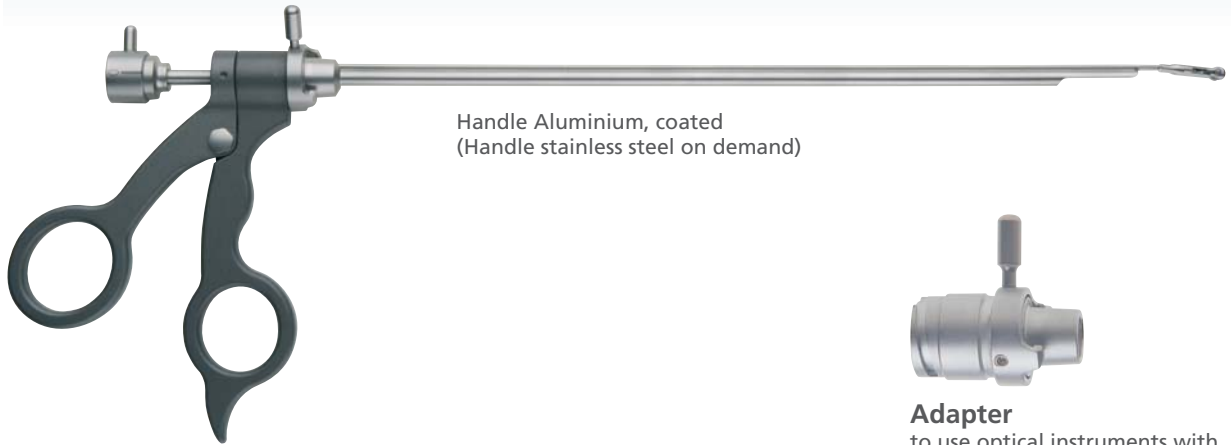

Handle Aluminium, coated
(Handle stainless steel on demand)



Adapter

to use optical instruments with
resectoscope sheaths (not for use with
stone forceps H50-021-105)



Optical scissors

for use with telescopes 0° / 12°

H50-021-100

H50-021-110



Optical biopsy forceps

for use with telescopes 0° / 12°

H50-021-101



Optical biopsy forceps

for use with telescopes 0° / 12°

H50-021-102



Optical biopsy forceps

with short jaw for use with telescopes 30°

H50-021-103

with short jaw for use with telescopes 70°

H50-021-106



Optical grasping forceps

for use with telescopes 0° / 12°

H50-021-104



Forceps

double action jaw
for use with telescopes 0° / 12°

H50-021-107

**Instruments for
Lithotripsy**

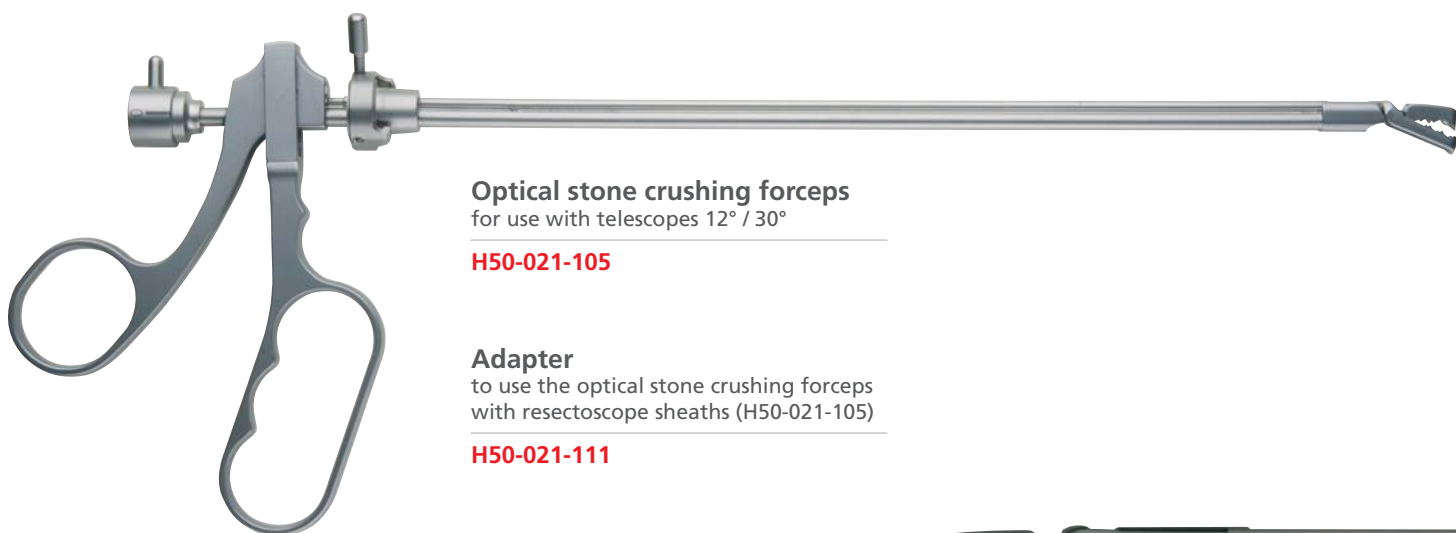

Optical stone crushing forceps
for use with telescopes 12° / 30°

H50-021-105

Adapter
to use the optical stone crushing forceps
with resectoscope sheaths (H50-021-105)

H50-021-111



Instruments for Lithotripsy

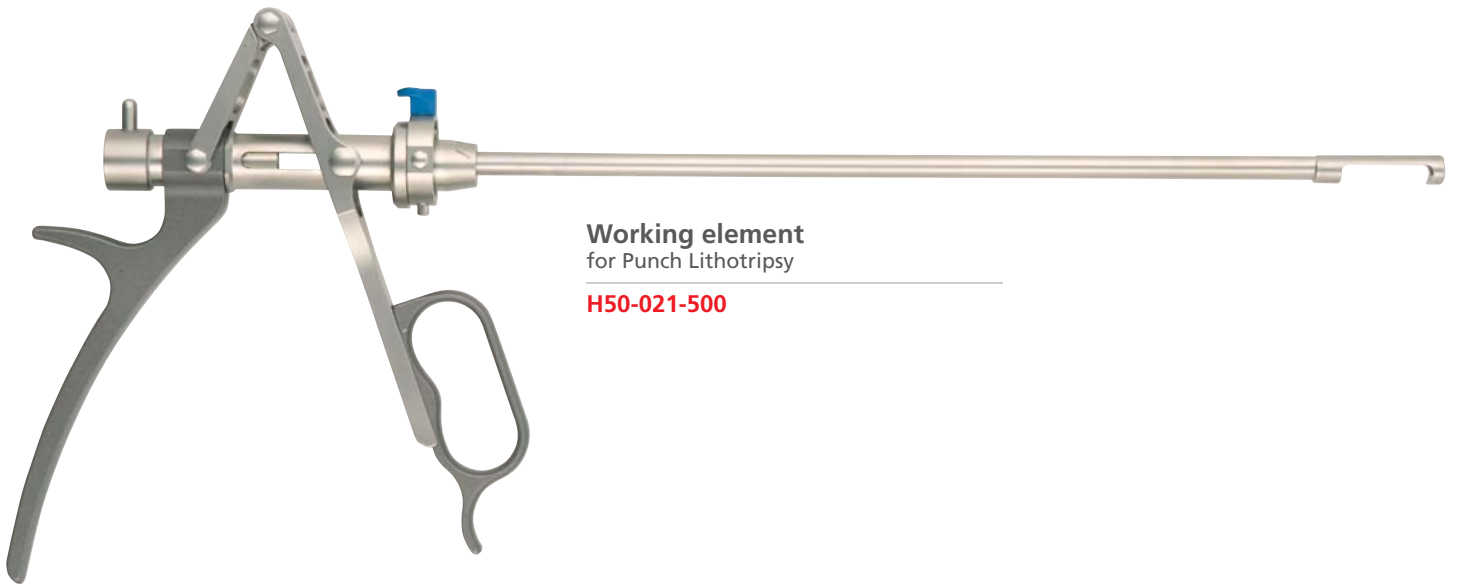

Working element
for Punch Lithotripsy

H50-021-500



Lithotripsy Sheath
with 2 fixed stopcocks,
complete with obturator

H50-021-510

Sheath only

H50-021-511

Obturator only

H50-021-512

Instruments for Lithotripsy

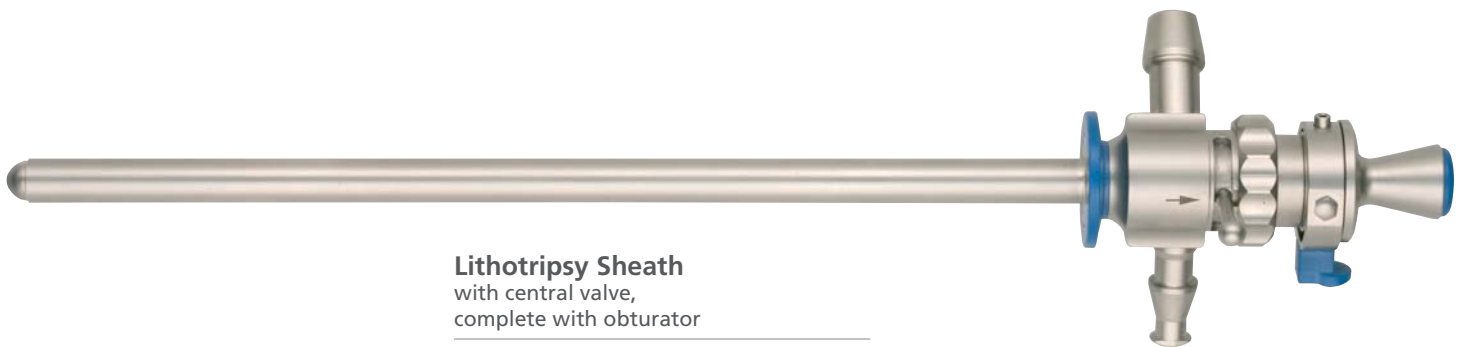

Lithotripsy Sheath
with central valve,
complete with obturator

H50-021-515

Sheath only

H50-021-516

Obturator only

H50-021-512



Working insert
for Lithotripsy Sheath,
with 7 Charr. working channel

H50-021-600



Instruments for Laser-Cystoscopy



**Laser Cystoscope /
Urethroscope-Sheath**
for continuous flow,
complete with obturator,
sheath 23 Charr., colour code blue

H50-023-510



Sheath only

H50-023-511

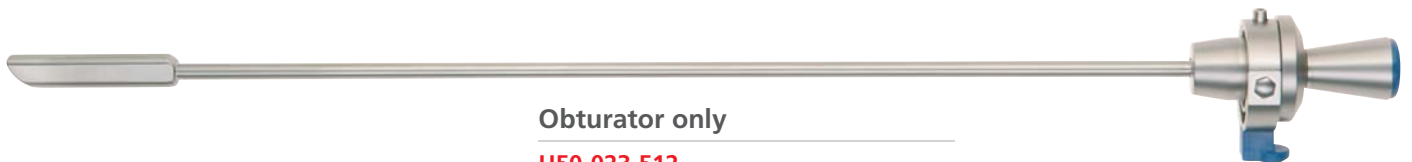

Obturator only

H50-023-512

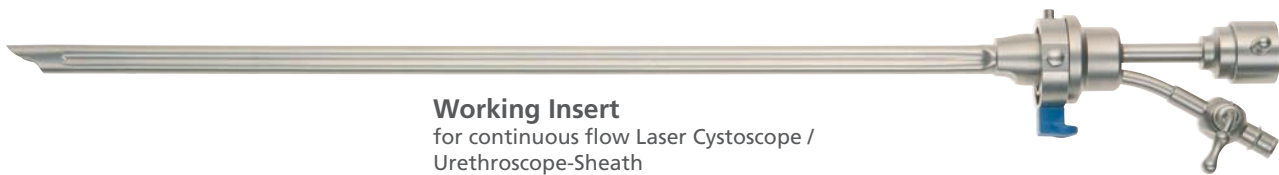

Working Insert
for continuous flow Laser Cystoscope /
Urethroscope-Sheath
with 8 Charr. working channel,
colour code blue

H50-023-520



Visual Obturator
for Laser Cystoscope / Urethroscope-Sheath
to use with scope 30°,
colour code blue

H50-023-517

Instruments for Laser-Resectoscopy

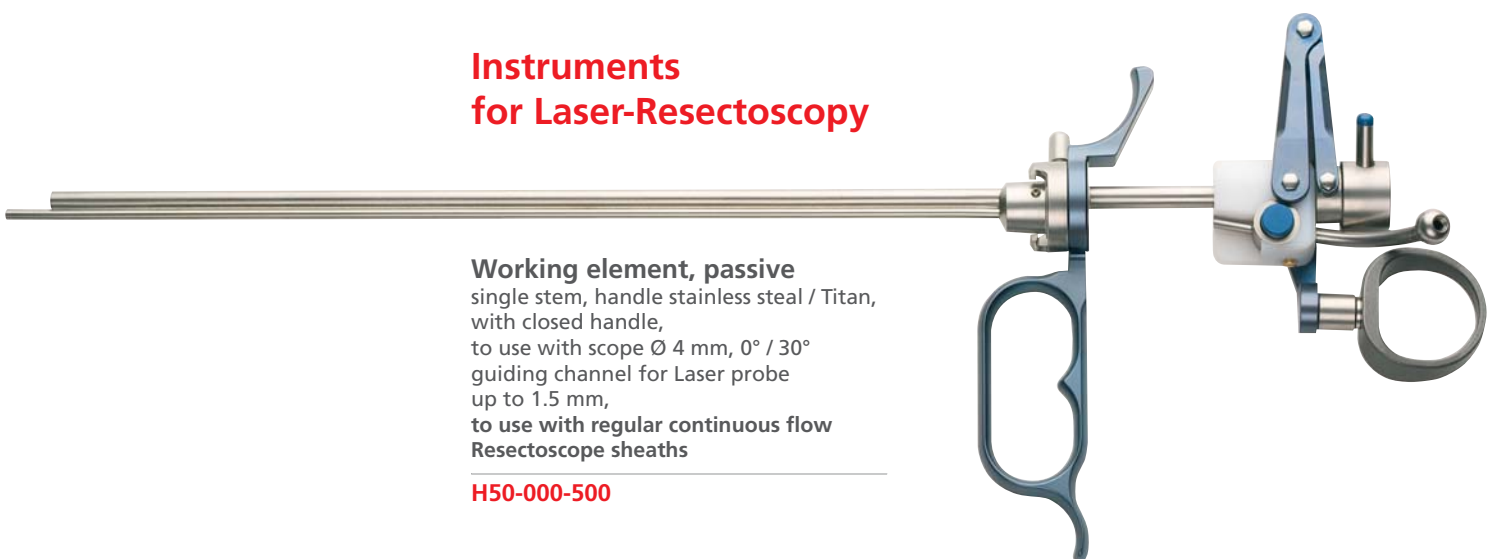

Working element, passive
single stem, handle stainless steel / Titan,
with closed handle,
to use with scope Ø 4 mm, 0° / 30°
guiding channel for Laser probe
up to 1.5 mm,
to use with regular continuous flow
Resectoscope sheaths

H50-000-500

Further instruments for
Laser-Cystoscopy / Laser-Resectoscopy
on request

Instruments for Resectoscopy



Working element, passive
single stem, handle Aluminium, coated
cutting by spring action - in still position
the electrode is inside the sheath

H50-000-000 with closed handle
H50-001-000 with open handle

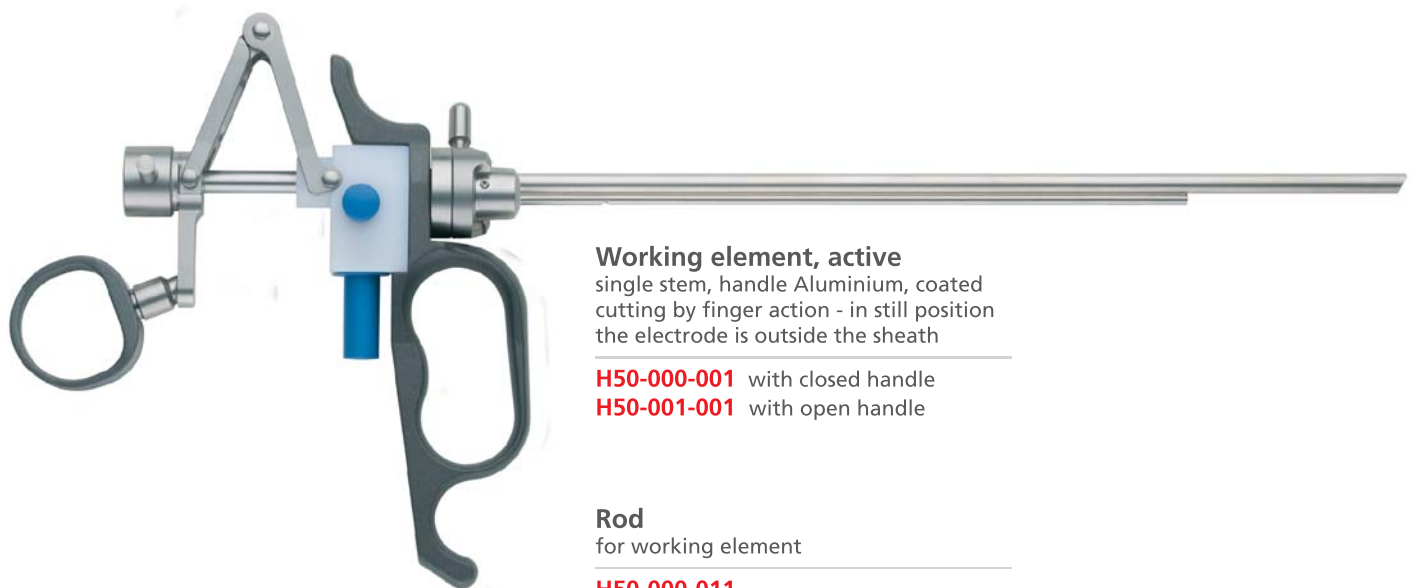
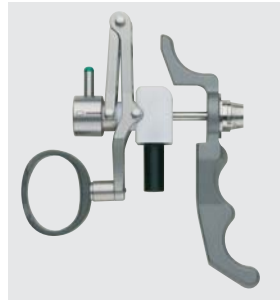

Working element, active
single stem, handle Aluminium, coated
cutting by finger action - in still position
the electrode is outside the sheath

H50-000-001 with closed handle
H50-001-001 with open handle

Rod
for working element

H50-000-011

Instruments for Resectoscopy



Loop electrode
angled 30°
single stem

24 Charr. **H50-024-200**
27 Charr. **H50-027-200**



Loop electrode
straight
single stem

24 Charr. **H50-024-201**
27 Charr. **H50-027-201**



Loop electrode
90° angled, for 0° scope
single stem

24 Charr. **H50-024-202**
27 Charr. **H50-027-202**



Knife electrode
single stem

24 Charr. **H50-024-203**
27 Charr. **H50-027-203**



Ball electrode
Ø 3 mm
single stem

24 Charr. **H50-024-204**
27 Charr. **H50-027-204**



Ball electrode
Ø 5 mm
single stem

24 Charr. **H50-024-205**
27 Charr. **H50-027-205**



Roller electrode
Ø 3 mm
single stem

24 Charr. **H50-024-206**
27 Charr. **H50-027-206**



Roller electrode
Ø 5 mm
single stem

24 Charr. **H50-024-207**
27 Charr. **H50-027-207**



Conical electrode
single stem

24 Charr. **H50-024-208**
27 Charr. **H50-027-208**

Instruments for Resectoscopy



Spike electrode

Ø 3 mm
single stem

24 Charr. **H50-024-209**
27 Charr. **H50-027-209**



Spike electrode

Ø 5 mm
single stem

24 Charr. **H50-024-210**
27 Charr. **H50-027-210**



Vaporization electrode

Ø 3 mm
single stem

24 Charr. **H50-024-211**
27 Charr. **H50-027-211**



Vaporization electrode

Ø 5 mm
single stem

24 Charr. **H50-024-212**
27 Charr. **H50-027-212**



Curette

sharp, round
single stem

24 Charr. **H50-024-213**
27 Charr. **H50-027-213**

Double stem electrodes on request



Protection groove for electrodes

Stainless steel

24 Charr. **H50-030-000**

connection to unit



HF-connection cable

Martin/Berchtold, Ø 4 mm

3 meters **H50-050-010**
5 meters **H50-055-010**

connection to unit



HF-connection cable

Erbe/Storz, Ø 5 mm

3 meters **H50-050-011**
5 meters **H50-055-011**

connection to unit



HF-connection cable

Valleylab/Bovie, Ø 8 mm

3 meters **H50-050-012**
5 meters **H50-055-012**

Instruments for Resectoscopy

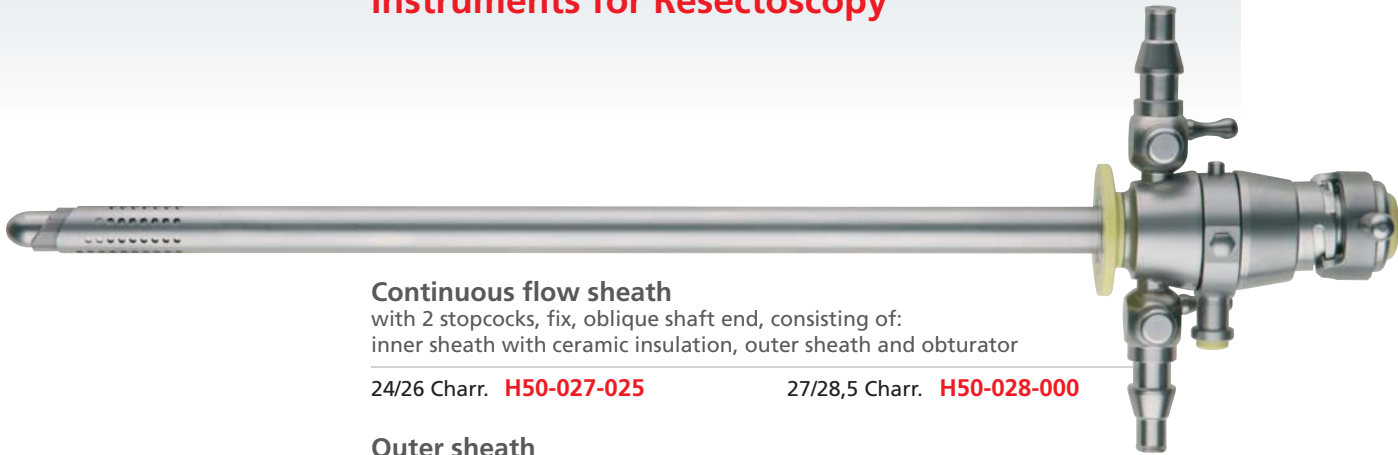

Continuous flow sheath

with 2 stopcocks, fix, oblique shaft end, consisting of:
inner sheath with ceramic insulation, outer sheath and obturator

24/26 Charr. **H50-027-025** 27/28,5 Charr. **H50-028-000**

Outer sheath

for continuous flow sheath with 2 stopcocks, fix

26 Charr. **H50-027-027** 28,5 Charr. **H50-028-002**

Inner sheath

with ceramic insulation for continuous flow sheath with 2 stopcocks, fix

24 Charr. **H50-024-026** 27 Charr. **H50-027-028**

Obturator

for resectoscope sheaths

24 Charr. **H50-024-040** 27 Charr. **H50-027-040**

To use with scopes Ø 4 mm, 302 mm length

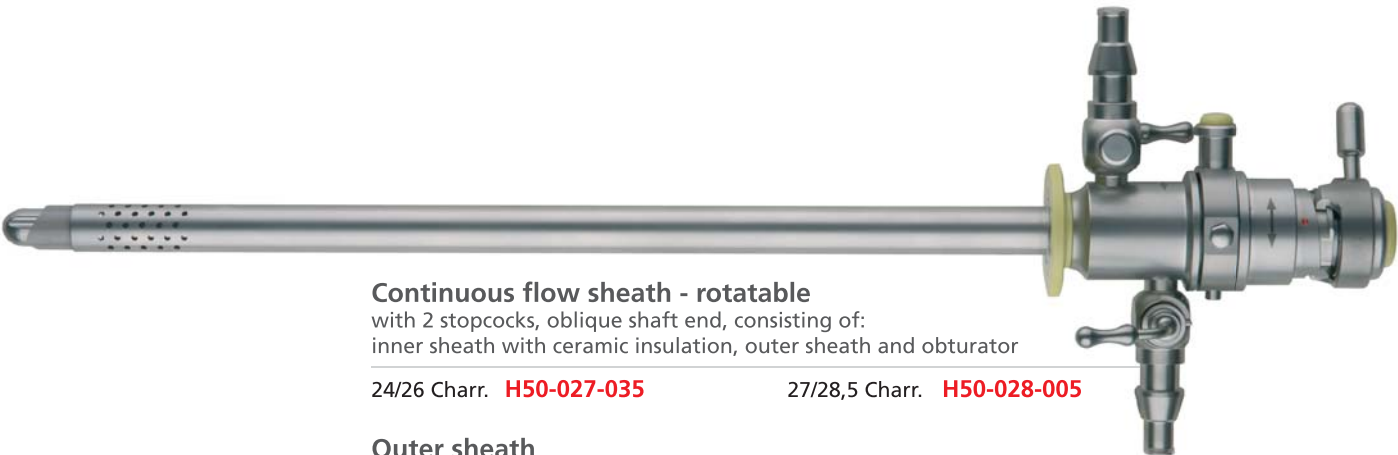

Continuous flow sheath - rotatable

with 2 stopcocks, oblique shaft end, consisting of:
inner sheath with ceramic insulation, outer sheath and obturator

24/26 Charr. **H50-027-035** 27/28,5 Charr. **H50-028-005**

Outer sheath

for continuous flow sheath with 2 stopcocks, rotating

26 Charr. **H50-027-037** 28,5 Charr. **H50-028-007**

Inner sheath

with ceramic insulation for continuous flow sheath with 2 stopcocks, rotating

24 Charr. **H50-024-036** 27 Charr. **H50-027-030**

Obturator

for resectoscope sheaths

24 Charr. **H50-024-040** 27 Charr. **H50-027-040**

To use with scopes Ø 4 mm, 302 mm length

Instruments for Resectoscopy



Resectoscope sheath

central valve, oblique shaft end with obturator

24 Charr. **H50-024-050**

27 Charr. **H50-027-050**

Sheath only

24 Charr. **H50-024-051**

27 Charr. **H50-027-051**

Obturator only

for resectoscope sheaths

24 Charr. **H50-024-040**

27 Charr. **H50-027-040**

To use with scopes Ø 4 mm, 302 mm length



Resectoscope sheath

with 1 stopcock, fix, oblique shaft end and obturator

24 Charr. **H50-024-060**

27 Charr. **H50-027-060**

Sheath only

24 Charr. **H50-024-061**

27 Charr. **H50-027-061**

Obturator only

for resectoscope sheaths

24 Charr. **H50-024-040**

27 Charr. **H50-027-040**

To use with scopes Ø 4 mm, 302 mm length

Instruments for Resectoscopy



Obturator
for resectoscope sheaths

24 Charr. **H50-024-040**

27 Charr. **H50-027-040**



Deflecting obturator
for resectoscope sheaths, with oblique shaft end

24 Charr. **H50-024-041**

27 Charr. **H50-027-041**

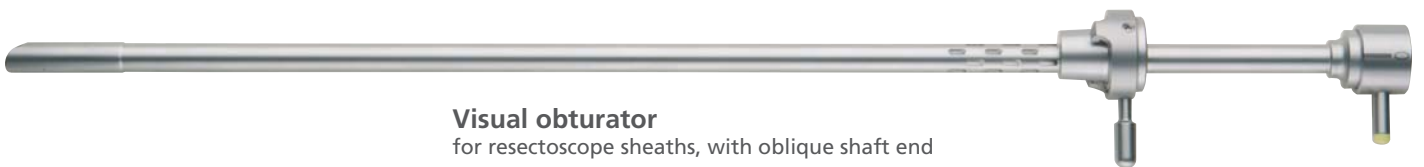

Visual obturator
for resectoscope sheaths, with oblique shaft end

24 Charr. **H50-024-042**

27 Charr. **H50-027-042**



Visual obturator with working channel
for resectoscope sheaths, with oblique shaft end

24 Charr. **H50-024-142**
with 5 Charr. working channel

27 Charr. **H50-027-142**
with 7 Charr. working channel

Further sizes and designs on request!

Instruments for Resectoscopy Slim Version

Telescopes see page 4

Slim working element, passive
single stem, handle Aluminium, coated
cutting by spring action - in still position
the electrode is inside the sheath

H50-000-002 with closed handle
H50-001-002 with open handle

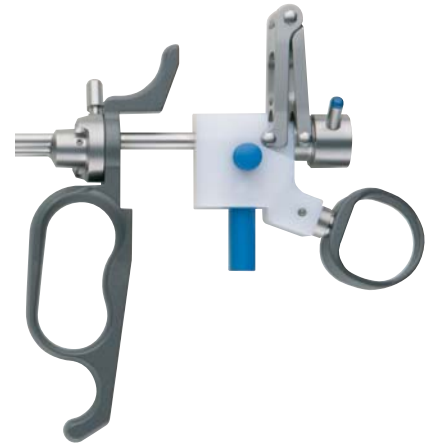

Slim working element, active
single stem, handle Aluminium, coated
cutting by finger action - in still position
the electrode is outside the sheath

H50-000-003 with closed handle
H50-001-003 with open handle

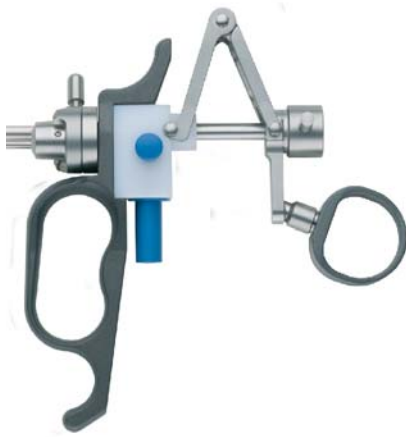
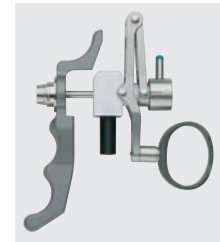

Loop electrode
angled 30°

19 Charr. **H50-019-004**



Knife electrode

19 Charr. **H50-019-005**



Ball electrode

19 Charr. **H50-019-006**

further electrodes on request



Continuous flow sheath
with 2 stopcocks, fix, consisting of:
inner sheath with ceramic insulation,
outer sheath and obturator, complete

19/22 Charr. **H50-022-000**

Outer sheath
for continuous flow sheath
with 2 stopcocks, fix

22 Charr. **H50-022-002**

To use with scopes Ø 2.7 mm, 302 mm length

Inner sheath
with ceramic insulation for continuous
flow sheath with 2 stopcocks, fix

19 Charr. **H50-019-019**

Obturator
for slim resectoscope sheaths

19 Charr. **H50-022-003**

**Instruments for Resectoscopy
Slim Version**

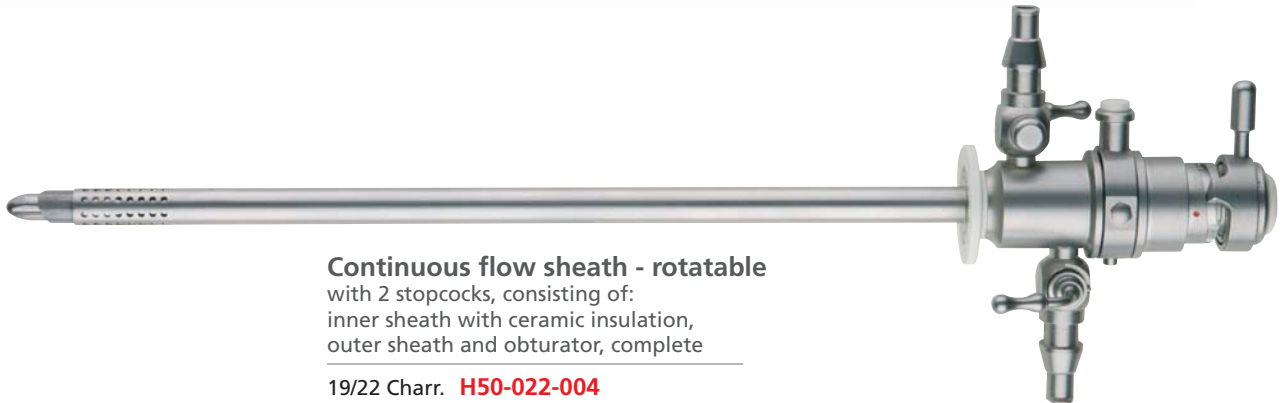

Continuous flow sheath - rotatable
with 2 stopcocks, consisting of:
inner sheath with ceramic insulation,
outer sheath and obturator, complete

19/22 Charr. **H50-022-004**

Outer sheath

for continuous flow sheath
with 2 stopcocks, rotating

22 Charr. **H50-022-006**

Inner sheath

with ceramic insulation for continuous
flow sheath with 2 stopcocks, rotating

19 Charr. **H50-019-020**

Obturator

for slim resectoscope sheaths

19 Charr. **H50-022-003**

To use with scopes Ø 2.7 mm, 302 mm length



Resectoscope sheath

for slim resectoscope with 1 stopcock,
fix and obturator, complete

19 Charr. **H50-019-021**

Sheath only

19 Charr. **H50-019-018**

Obturator only

19 Charr. **H50-022-003**

To use with scopes Ø 2.7 mm, 302 mm length



Visual obturator

for resectoscope sheath

19/22 Charr. **H50-022-007**

Instruments for Pediatric-Resectoscopy

Cystoscopy

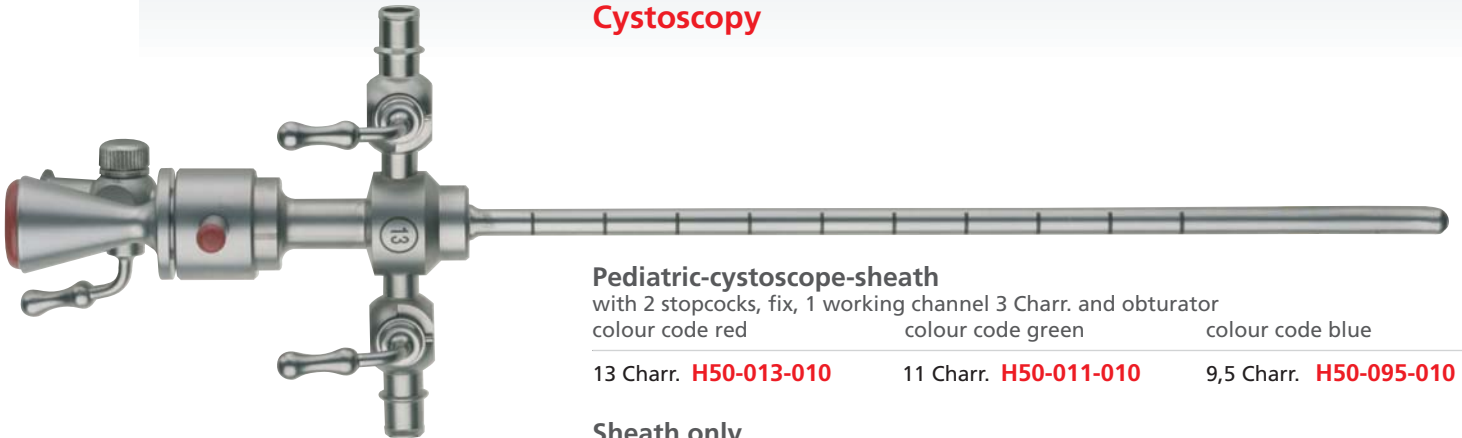

Pediatric-cystoscope-sheath

with 2 stopcocks, fix, 1 working channel 3 Charr. and obturator
 colour code red colour code green colour code blue

13 Charr. **H50-013-010** 11 Charr. **H50-011-010** 9,5 Charr. **H50-095-010**

Sheath only

13 Charr. **H50-013-011** 11 Charr. **H50-011-011** 9,5 Charr. **H50-095-011**

Obturator

for cystoscope-urethroscope sheath

13 Charr. **H50-013-012** 11 Charr. **H50-011-012** 9,5 Charr. **H50-095-012**



Telescope bridge

for pediatric-cystoscope-sheath

13 Charr. **H50-013-018**

To use with scopes

Ø 2.7 mm, 187 mm length Ø 2.7/2 mm, 187 mm length Ø 2.0 mm, 187 mm length

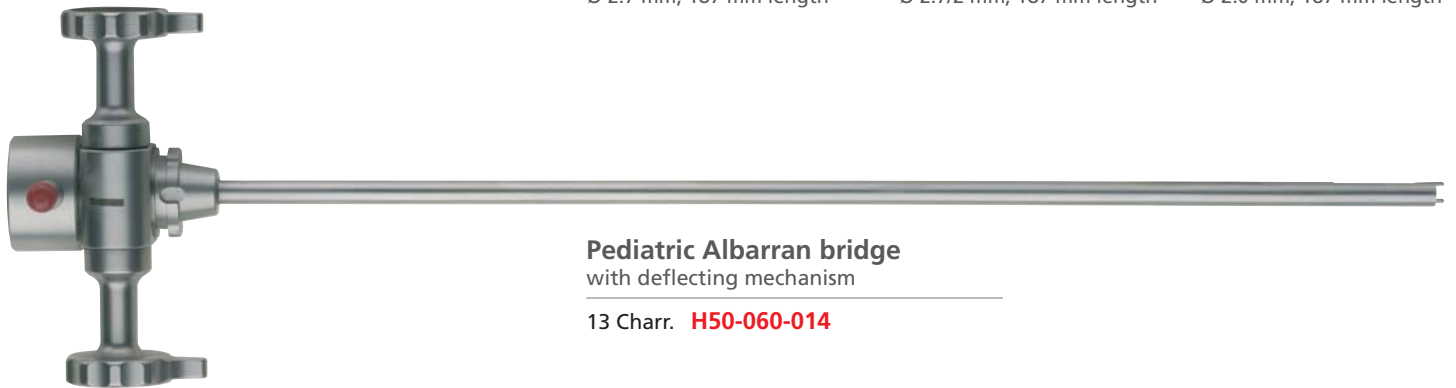

Pediatric Albarran bridge

with deflecting mechanism

13 Charr. **H50-060-014**

Instruments for Resectoscopy

Telescopes see page 4

Pediatric working element, passive

single stem, handle Aluminium, coated

cutting by spring action - in still position the electrode is inside the sheath

13 Charr. **H50-000-004**

11 Charr. **H50-000-008**

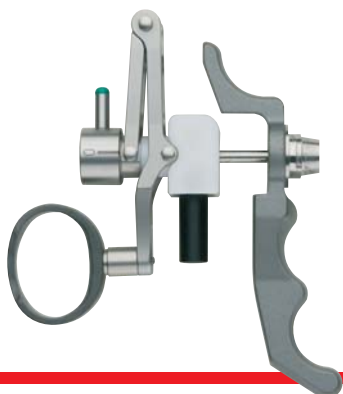

Instruments for Pediatric-Resectoscopy

Loop electrode

small

colour code red

13 Charr. **H50-013-020**

colour code green

11 Charr. **H50-011-020**



Loop electrode

large

13 Charr. **H50-013-021**

11 Charr. **H50-011-021**



Knife electrode

13 Charr. **H50-013-022**

11 Charr. **H50-011-022**



Ball electrode

13 Charr. **H50-013-023**

11 Charr. **H50-011-023**



Hook electrode

13 Charr. **H50-013-024**

11 Charr. **H50-011-024**



Standard-pediatric-sheath

with 1 stopcock, fix, and obturator

13 Charr. **H50-013-016**

11 Charr. **H50-011-016**

Sheath only

13 Charr. **H50-013-015**

11 Charr. **H50-011-015**

Obturator only

for resectoscope sheaths

13 Charr. **H50-013-017**

11 Charr. **H50-011-017**

To use with scopes
Ø 2.7 mm, 187 mm length

Ø 2.7/2.0 mm, 187 mm length



Instruments for Pediatric-Resectoscopy

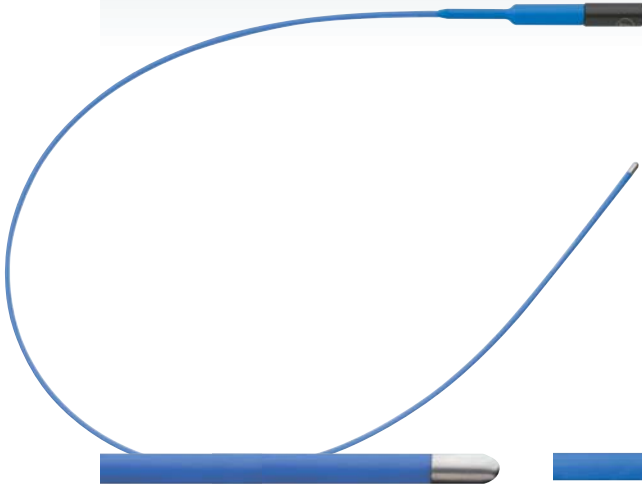

Flexible button electrode
working length 45 cm

3 Charr. **H50-351-000**



Flexible needle electrode
working length 45 cm

3 Charr. **H50-351-001**



Flexible loop electrode
working length 45 cm

3 Charr. **H50-351-002**



Scissors
with flexible shaft, 40 cm

3 Charr. **H50-003-010**



Biopsy forceps
with flexible shaft, 40 cm

3 Charr. **H50-003-011**



Biopsy forceps
with flexible shaft, spoon serrated, 40 cm

3 Charr. **H50-003-013**

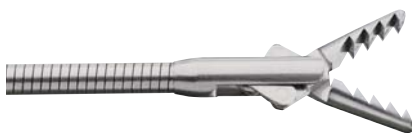

Forceps
for removal of foreign bodies
with flexible shaft, 40 cm

3 Charr. **H50-003-012**



Also available in shorter version.
Other diameters see page 11.

Instruments for Urethrotomy



Working element, passive
single stem, handle Aluminium, coated
cutting by spring action - in still position
the electrode is inside the sheath

H50-000-000 with closed handle

H50-001-000 with open handle

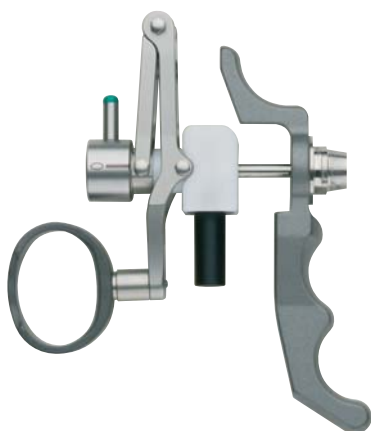
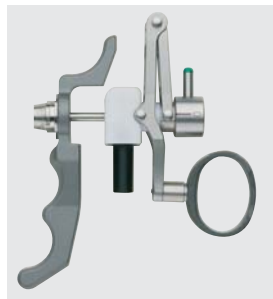

Working element, passive - for Pediatric Urethrotomy

single stem, handle Aluminium, coated
cutting by spring action - in still position the electrode is inside the sheath

13 Charr. **H50-000-004**

11 Charr. **H50-000-008**

Instruments for Urethrotomy

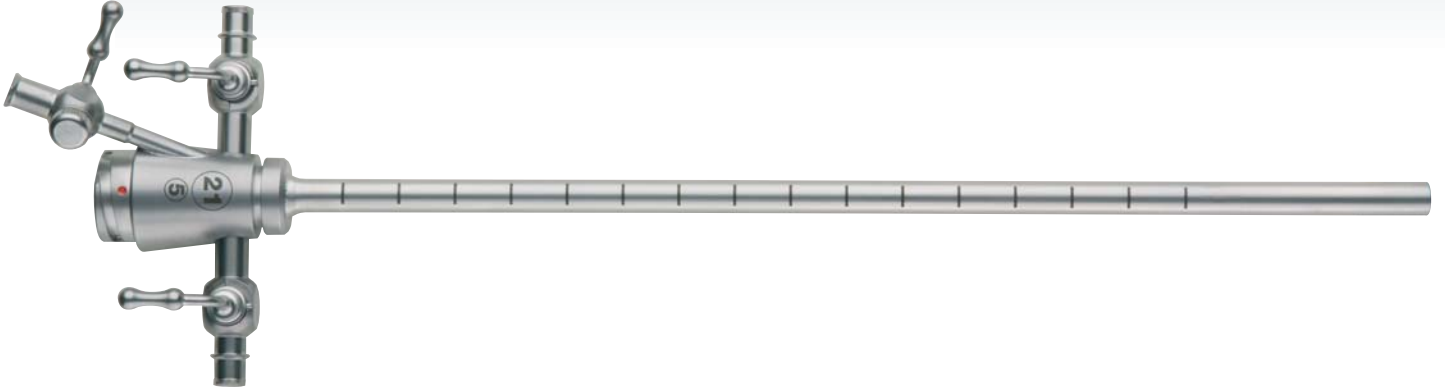

Urethrotome-Sheath only

with 1 instrument channel, 5 Charr., 2 stopcocks, fix

21 Charr. **H50-021-021**

17 Charr. **H50-017-021**

13 Charr. **H50-013-041**

11 Charr. **H50-011-041**

To use with scopes
Ø 4.0 mm, 302 mm length

Ø 4.0 or 2.7 mm, 302 mm length

Ø 2.7 mm, 187 mm length

Ø 2.7 or 2.0 mm, 187 mm length



Standard Obturator only for Urethrotome-sheath

21 Charr. **H50-021-022**

17 Charr. **H50-017-022**

13 Charr. **H50-013-042**

11 Charr. **H50-011-042**

Hollow Obturator for Urethrotome sheath (not illustrated)

21 Charr. **H50-021-024**

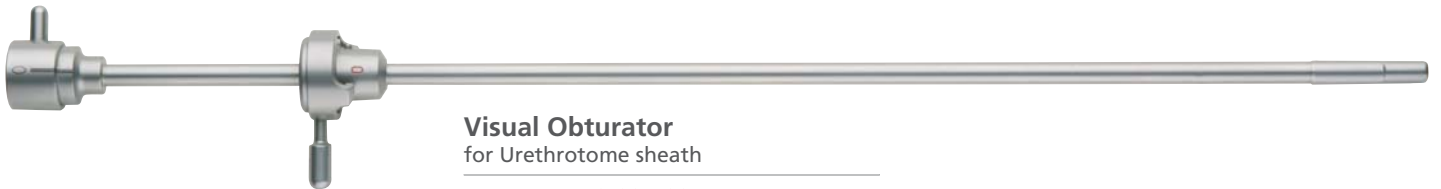

Visual Obturator for Urethrotome sheath

21 Charr. **H50-021-025**



Supplementary sheath half-round, to insert a ballon catheter

21 Charr. **H50-050-020**

17 Charr. **H50-050-023**

Instruments for Urethrotomy

Supplementary sheath

for urethrotome sheath to get continuous flow

21 Charr. **H50-050-021**



Telescope bridge

with 1 instrument channel,
5 Charr. for urethrotome

5 Charr. for urethrotome

3 Charr. for urethrotome

21 Charr. **H50-050-003**

17 Charr. **H50-050-005**

13 Charr. **H50-050-004**

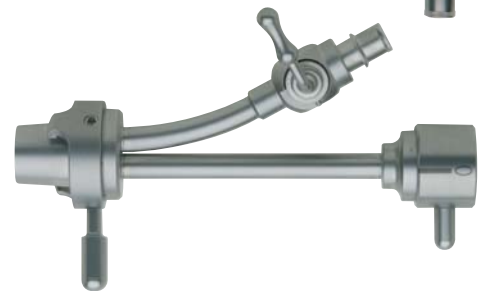

Urethrotome knife

straight

21 Charr. **H50-021-220**

17 Charr. **H50-017-220**

13 Charr. **H50-013-220**

11 Charr. **H50-011-220**



Urethrotome knife

round

21 Charr. **H50-021-221**

17 Charr. **H50-017-221**

13 Charr. **H50-013-221**

11 Charr. **H50-011-221**



Urethrotome knife

straight serrated

21 Charr. **H50-021-222**

17 Charr. **H50-017-222**



Urethrotome knife

ring-like

21 Charr. **H50-021-223**



Urethrotome knife

hook-like

21 Charr. **H50-021-224**

17 Charr. **H50-017-224**

13 Charr. **H50-013-224**

11 Charr. **H50-011-224**



Urethrotome knife

sickle-like

13 Charr. **H50-013-225**

11 Charr. **H50-011-225**



Instruments for Urethrotomy

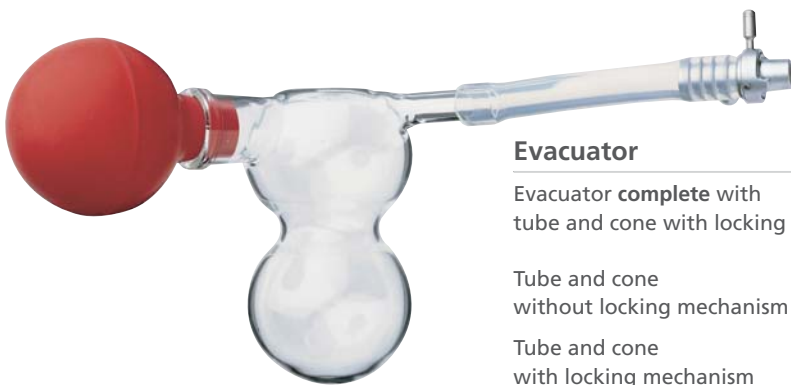

Evacuator

Evacuator **complete** with tube and cone with locking mechanism

H50-050-030

Tube and cone without locking mechanism

H50-050-032

Tube and cone with locking mechanism

H50-050-033

Glass bulb for Evacuator

H50-050-034

Rubber bulb for Evacuator

H50-050-035

Luer-Lock tube connection

H50-050-036

Luer-Lock tube connection, with stopcock

H50-050-037

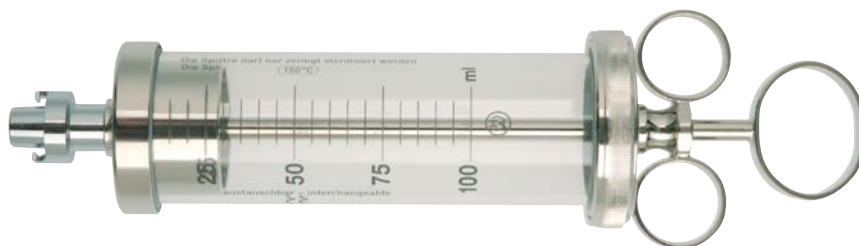

Janet GS RECORD Syringe

50 ml **H50-055-050**

75 ml **H50-055-075**

100 ml **H50-055-100**

150 ml **H50-055-150**

200 ml **H50-055-200**

Spare barrel with locking adapter

50 ml **H50-056-050**

75 ml **H50-056-075**

100 ml **H50-056-100**

150 ml **H50-056-150**

200 ml **H50-056-200**

Instruments for Urethrotomy

OTIS Urethrotome complete
consisting of a urethrotome,
2 knives, 3 tips, in a wooden case

H50-040-000



OTIS Urethrotome

H50-040-001



Ball tip
for OTIS urethrotome

H50-040-002



Flat tip
for OTIS urethrotome

H50-040-003



Conical tip
for OTIS urethrotome

H50-040-004



Knife
for OTIS urethrotome

H50-040-005

Instruments for Nephroscopy

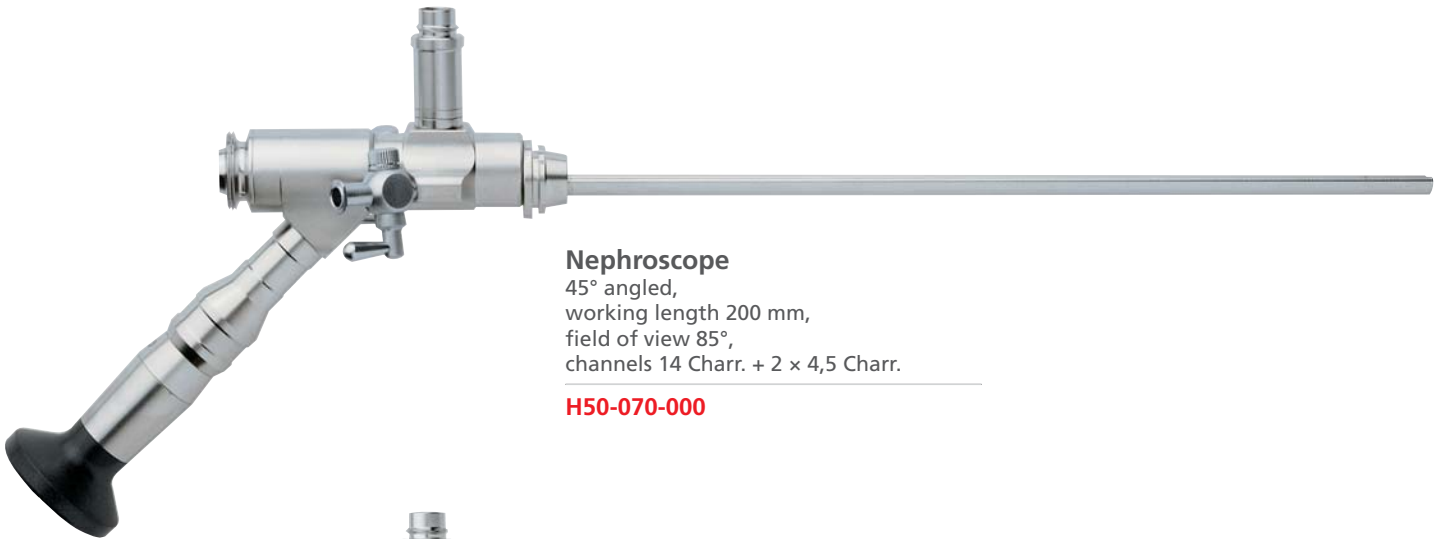

Nephroscope

45° angled,
working length 200 mm,
field of view 85°,
channels 14 Charr. + 2 x 4,5 Charr.

H50-070-000



Nephroscope

90° angled,
working length 200 mm,
field of view 85°,
channels 14 Charr. + 2 x 4,5 Charr.

H50-070-001

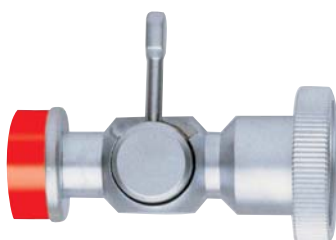

Stopcock

for nephroscope, Ø 4,8 mm

24 Charr. **H50-070-005**

Instruments for Nephroscopy

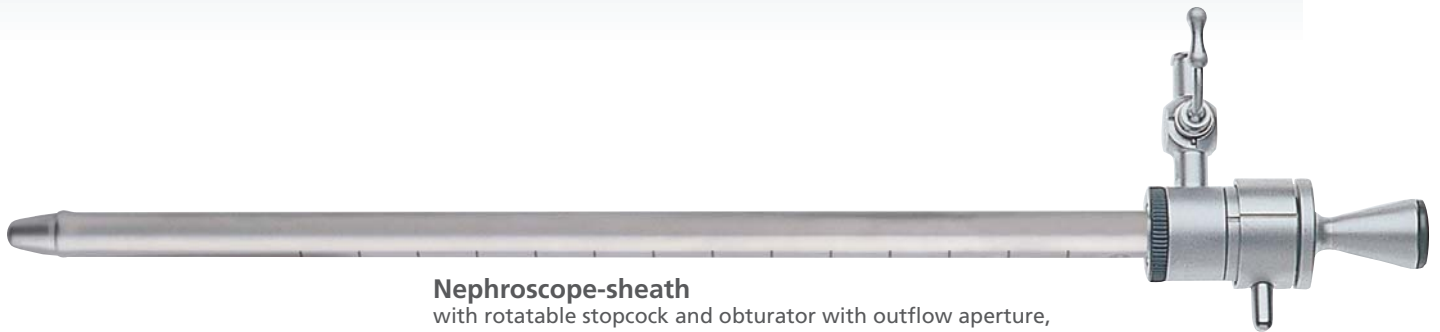

Nephroscope-sheath

with rotatable stopcock and obturator with outflow aperture,
working length 200 mm

24 Charr. **H50-071-025**

26 Charr. **H50-071-015**

Sheath only

24 Charr. **H50-071-026**

26 Charr. **H50-071-016**

Obturator only

for nephroscope-sheath

24 Charr. **H50-070-012**

26 Charr. **H50-070-017**

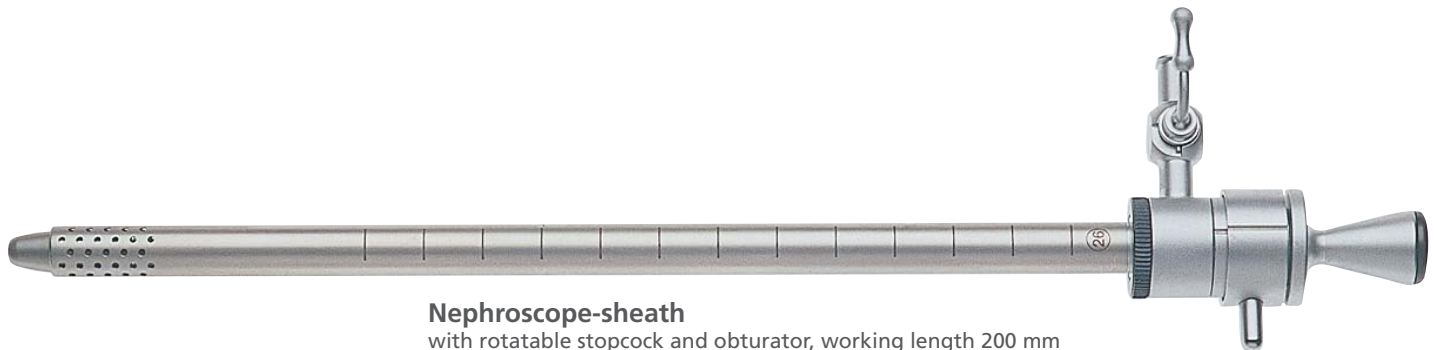

Nephroscope-sheath

with rotatable stopcock and obturator, working length 200 mm

24 Charr. **H50-070-025**

26 Charr. **H50-070-015**

Sheath only

24 Charr. **H50-070-026**

26 Charr. **H50-070-016**

Obturator only

for nephroscope-sheath

24 Charr. **H50-070-012**

26 Charr. **H50-070-017**



Telescope-dilator

consisting of 6 dilators with 9, 12,
15, 18, 21, 24 Charr. with 1 each rigid
and flexible hollow guide probes.

H50-070-020

Additional dilators

27 Charr.

30 Charr.

H50-070-021

H50-070-022

Instruments for Nephroscopy



Stone grasping forceps
with fenestrated jaws and spring handle,
10,5 Charr.

330 mm **H50-070-030**
420 mm **H50-070-036**



Stone grasping forceps
with spring handle, for larger stones,
10,5 Charr.

330 mm **H50-070-031**
420 mm **H50-070-037**



Stone grasping forceps
with fenestrated jaws and spring handle,
10,5 Charr.

330 mm **H50-070-032**
420 mm **H50-070-038**



Biopsy forceps
single action jaw, with ring handle,
10,5 Charr.

330 mm **H50-070-033**
420 mm **H50-070-039**



Stone grasping forceps
heavy serrated, with ring handle,
10,5 Charr.

330 mm **H50-070-034**
420 mm **H50-070-040**



Micro scissor
straight, single action,
10,5 Charr.

330 mm **H50-070-035**
420 mm **H50-070-041**

Instruments for Uretero-Renoscropy

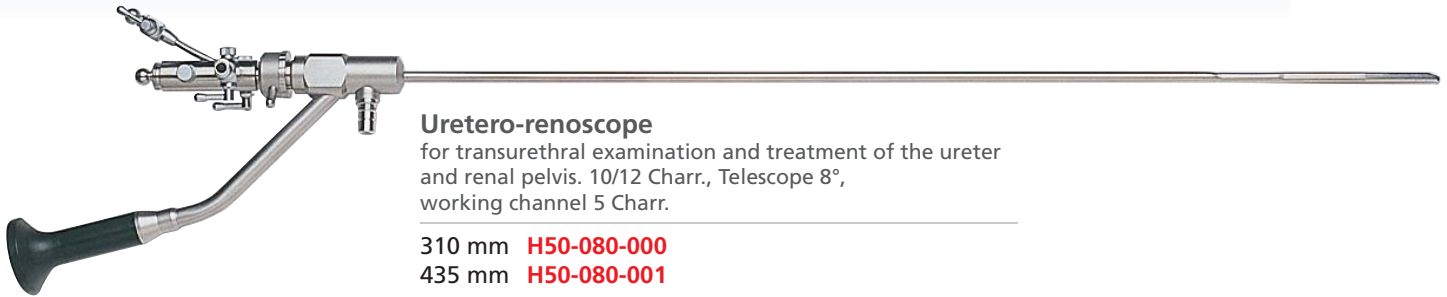

Uretero-roscope
for transurethral examination and treatment of the ureter and renal pelvis. 10/12 Charr., Telescope 8°, working channel 5 Charr.

310 mm **H50-080-000**
435 mm **H50-080-001**

Adapter
for EMS-Lithotriptor
H50-080-010



Stone grasping forceps
length 60 cm, double action jaws
rigid

4 Charr. **H50-080-100**
5 Charr. **H50-080-101**

flexible

4 Charr. **H50-080-200**
5 Charr. **H50-080-201**



Stone grasping forceps
for larger stones, length 60 cm, double action jaws
rigid

4 Charr. **H50-080-102**
5 Charr. **H50-080-103**

flexible

4 Charr. **H50-080-202**
5 Charr. **H50-080-203**

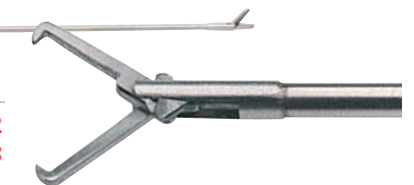

Long stone grasping forceps
length 60 cm, double action jaws
rigid

4 Charr. **H50-080-104**
5 Charr. **H50-080-105**

flexible

4 Charr. **H50-080-204**
5 Charr. **H50-080-205**



Biopsy forceps
length 60 cm, double action jaws
rigid

4 Charr. **H50-080-106**
5 Charr. **H50-080-107**

flexible

4 Charr. **H50-080-206**
5 Charr. **H50-080-207**



Scissors
length 60 cm, single action jaws
rigid

4 Charr. **H50-080-108**
5 Charr. **H50-080-109**

flexible

4 Charr. **H50-080-208**
5 Charr. **H50-080-209**



Accessories

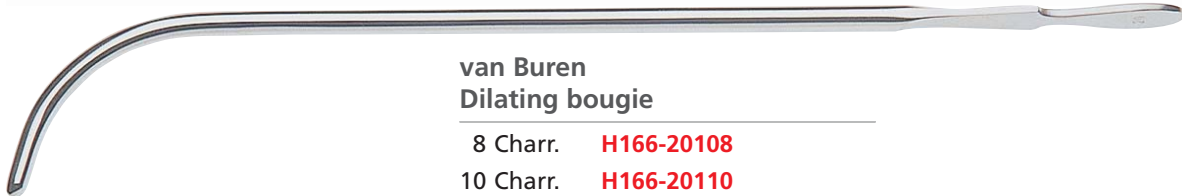

van Buren Dilating bougie

8 Charr.	H166-20108
10 Charr.	H166-20110
12 Charr.	H166-20112
14 Charr.	H166-20114
16 Charr.	H166-20116
18 Charr.	H166-20118
20 Charr.	H166-20120
22 Charr.	H166-20122
24 Charr.	H166-20124
26 Charr.	H166-20126
28 Charr.	H166-20128
30 Charr.	H166-20130
32 Charr.	H166-20132
34 Charr.	H166-20134
36 Charr.	H166-20136



Guyon Dilating bougie

8 Charr.	H166-20508
10 Charr.	H166-20510
12 Charr.	H166-20512
14 Charr.	H166-20514
16 Charr.	H166-20516
18 Charr.	H166-20518
20 Charr.	H166-20520
22 Charr.	H166-20522
24 Charr.	H166-20524
26 Charr.	H166-20526
28 Charr.	H166-20528
30 Charr.	H166-20530
32 Charr.	H166-20532
34 Charr.	H166-20534
36 Charr.	H166-20536
38 Charr.	H166-20538
40 Charr.	H166-20540

Accessories

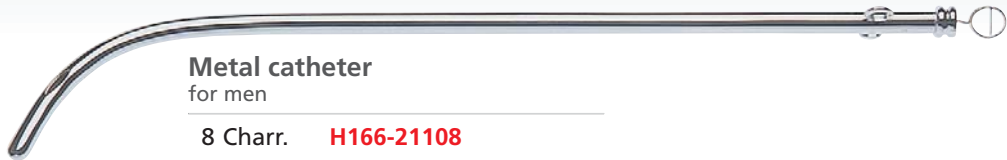

Metal catheter for men

- 8 Charr. **H166-21108**
- 10 Charr. **H166-21110**
- 12 Charr. **H166-21112**
- 14 Charr. **H166-21114**
- 16 Charr. **H166-21116**
- 18 Charr. **H166-21118**
- 20 Charr. **H166-21120**
- 22 Charr. **H166-21122**
- 24 Charr. **H166-21124**



Metal catheter for women

- 8 Charr. **H166-21308**
- 10 Charr. **H166-21310**
- 12 Charr. **H166-21312**
- 14 Charr. **H166-21314**
- 16 Charr. **H166-21316**
- 18 Charr. **H166-21318**
- 20 Charr. **H166-21320**
- 22 Charr. **H166-21322**
- 24 Charr. **H166-21324**



Coxeter-prostate-catheter

- 8 Charr. **H166-21908**
- 10 Charr. **H166-21910**
- 12 Charr. **H166-21912**
- 14 Charr. **H166-21914**
- 16 Charr. **H166-21916**
- 18 Charr. **H166-21918**
- 20 Charr. **H166-21920**
- 22 Charr. **H166-21922**
- 24 Charr. **H166-21924**

Accessories



Meatus clamp
STOCKMANN

8 cm **H166-17508**



Meatus clamp
STRAUSS

11 cm **H166-17711**



Catheter introducer
GUYON

straight

curved

39 cm **H166-18439**

35 cm **H166-18535**

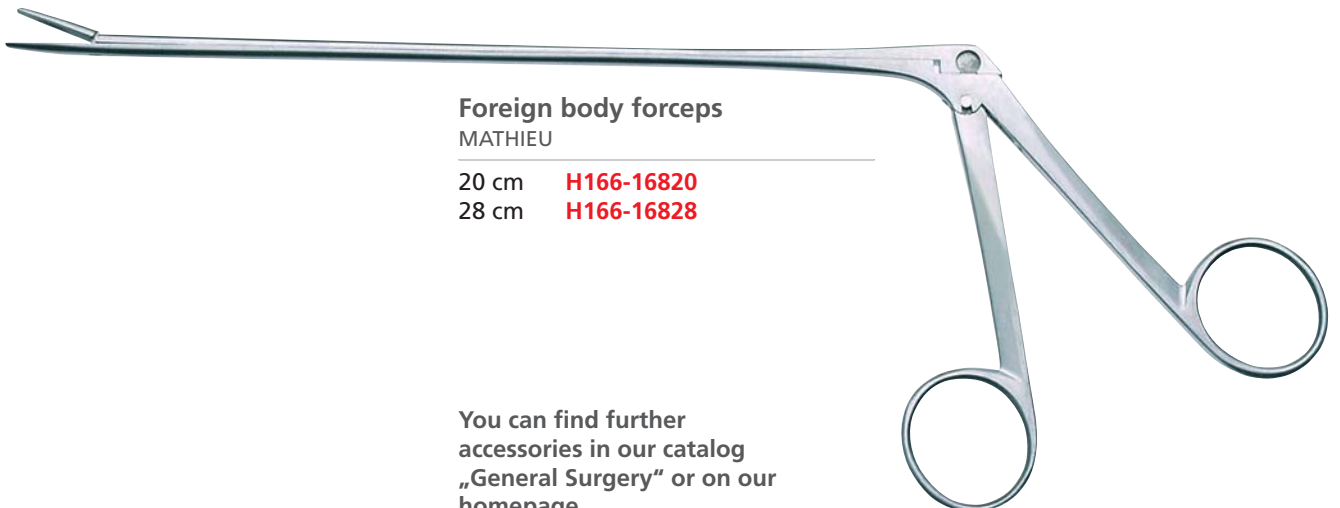

Foreign body forceps
MATHIEU

20 cm **H166-16820**

28 cm **H166-16828**

You can find further accessories in our catalog „General Surgery“ or on our homepage.

Hysteroscopy



Telescopes

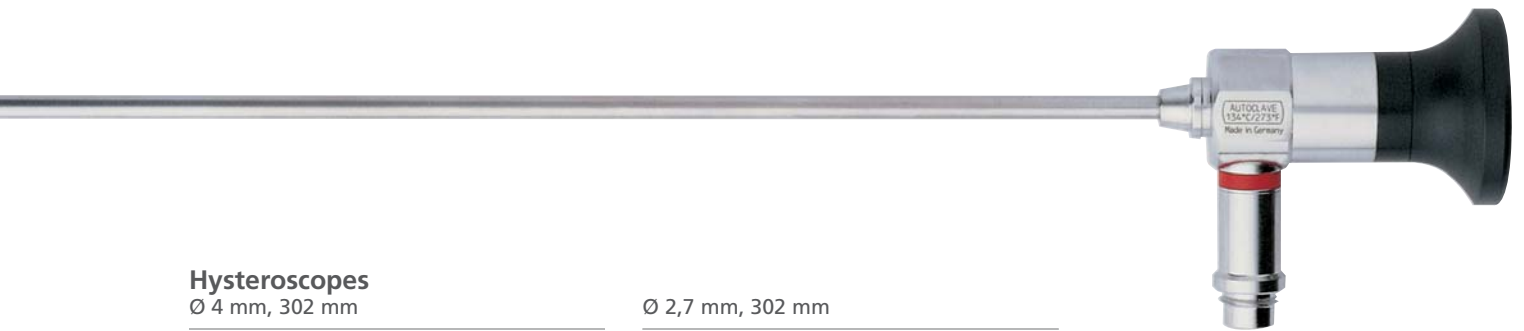

Hysteroscopes

Ø 4 mm, 302 mm

0°	H85-040-000
12°	H85-040-012
30°	H85-040-030
70°	H85-040-070

Ø 2,7 mm, 302 mm

0°	H85-027-000
12°	H85-027-012
30°	H85-027-030
70°	H85-027-070

Telescope cases,
cold light cables and
light guide adapters
please see page 4,5

Diagnostic



Examination sheath

with 1 rotatable stopcock,
complete with obturator

outer Ø 5 mm		colour code	Sheath only	Obturator only
scope 30°, 4 mm	H51-010-001	blue	H51-011-001	H51-012-000
scope 0°, 4 mm	H51-010-002	blue	H51-011-002	H51-012-000
outer Ø 3.7 mm				
scope 30°, 2.7 / 2.9 mm	H51-020-001	white	H51-021-001	H51-022-000
scope 0°, 2.7 / 2.9 mm	H51-020-002	white	H51-021-002	H51-022-000
outer Ø 2.6 mm				
scope 30°, 2.0 mm	H51-030-001	red	H51-031-001	H51-032-000
scope 12°, 2.0 mm	H51-030-002	red	H51-031-002	H51-032-000
scope 0°, 2.0 mm	H51-030-003	red	H51-031-003	H51-032-000

Diagnostic



**Continuous flow
Hysteroscopy sheath**
without instrument channel

Outer sheath

continuous flow, \varnothing 6.5 mm
for scope \varnothing 4.0 mm

colour code

H51-050-001 blue

for adaption
to inner sheath
H51-051-002 or
H51-051-003

continuous flow, \varnothing 5.0 mm
for scope \varnothing 2.9 / 2.7 mm

colour code

H51-060-001 white

for adaption
to inner sheath
H51-061-002 or
H51-061-003

continuous flow, \varnothing 3.4 mm
for scope \varnothing 2.0 mm

colour code

H51-070-001 red

for adaption
to inner sheath
H51-071-002 or
H51-071-003

Inner sheath

single flow

\varnothing 5.4 mm / 0° / 12° **H51-051-002**
 \varnothing 5.4 mm / 30° / 12° **H51-051-003**

single flow

\varnothing 3.7 mm / 0° **H51-061-002**
 \varnothing 3.7 mm / 30° **H51-061-003**

single flow

\varnothing 2.6 mm / 0° **H51-071-002**
 \varnothing 2.6 mm / 30° **H51-071-003**

Obturator

H51-051-000

Obturator

H51-061-000

Obturator

H51-071-000

Operating Sheaths

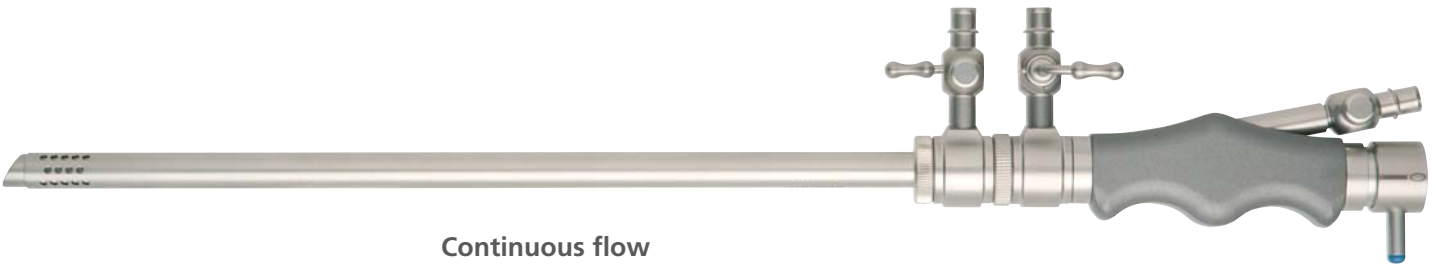

Continuous flow Hysteroscopy sheath

with instrument channel, 7 Charr.
2 rotatable stopcocks,
working length 200 mm,
outer Ø 8.0 mm

to use with scope
4.0 mm / 0°
4.0 mm / 30°

H51-090-001
H51-090-002

with instrument channel, 5 Charr.
2 rotatable stopcocks,
working length 200 mm,
outer Ø 6.5 mm

to use with scope
2.7 / 2.9 mm / 0°
2.7 / 2.9 mm / 30°

H51-091-005
H51-091-006



Hysteroscopy operating sheath

2 rotatable stopcocks,
outer sheath Ø 8.0 mm,
1x7 Charr. Instrument channel,
working length 215 mm

to use with scope
4.0 mm / 0°
4.0 mm / 30°

H51-110-001
H51-110-002

2x7 Charr. Instrument channel,
working length 215 mm

to use with scope
4.0 mm / 0°
4.0 mm / 30°

H51-120-001
H51-120-002

Operating Sheaths



Continuous flow outer sheath

1 fix stopcock, drop shaped,
for scope Ø 4.0 mm

		colour code
working length 190 mm	H51-210-001	blue
working length 190 mm	H51-210-002	blue

1 fix stopcock, drop shaped,
for scope Ø 2.7 / 2.9 mm

		colour code
working length 190 mm	H51-210-003	white

1 fix stopcock, oval,
for scope Ø 2.0 mm

		colour code
working length 190 mm	H51-210-004	red

Examination insert

1 fix stopcock

		colour code
--	--	-------------

1x5 Charr. Instrument channel to use with H51-210-001	H51-220-001	blue
--	--------------------	------

1x7 Charr. Instrument channel to use with H51-210-002	H51-220-002	blue
--	--------------------	------

1 fix stopcock

		colour code
--	--	-------------

1x5 Charr. Instrument channel to use with H51-210-003	H51-220-003	white
--	--------------------	-------

1 fix stopcock

		colour code
--	--	-------------

1x5 Charr. Instrument channel to use with H51-210-004	H51-220-004	red
--	--------------------	-----

Operating Sheaths



**Operating continuous flow
Hysteroscopy sheath,**
1 rotatable stopcock,
oval, 21 Charr. for \varnothing 4.0 mm scope 30°
working length 183 mm

H51-250-001



Obturator

H51-251-000



**Working insert for continuous
flow Hysteroscopy Operating
sheath,**
oval, 21 Charr. with 1 x 7 Charr. working
channel and 1 stopcock

H51-251-001

Operating Sheaths



Continuous flow outer sheath
with rotatable stopcock, round, Ø 8 mm,
working length 180mm

H51-261-001

Obturator

H51-262-001

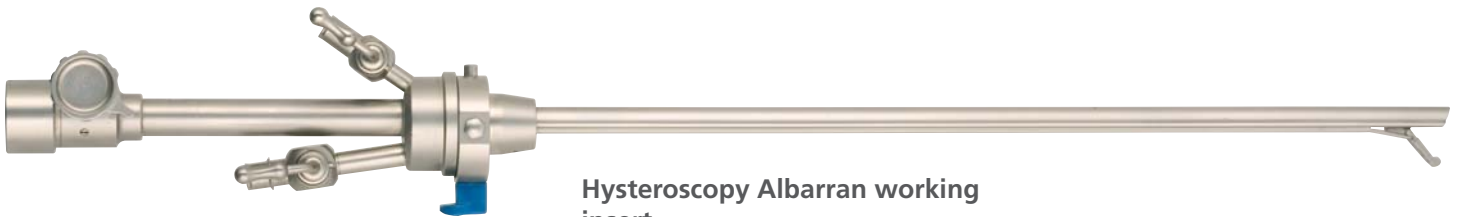

Hysteroscopy Albarran working insert

with deflecting mechanism,
with 1 x 7 Charr. working channel
and 1 stopcock,
with ratchet

H51-260-001

Additional instruments

Flexible Instruments

for Hysteroscopy, 5 Charr.
(to use with 2.7 / 2.9 mm Hysteroscopes)

see page 11

Flexible Instruments

for Hysteroscopy, 7 Charr.
(to use with 4.0 mm Hysteroscopes)

see page 11

Flexible Electrodes

monopolar, for Hysteroscopy, 5 Charr.
(to use with 2.7 / 2.9 mm Hysteroscopes)

see page 10

Flexible Electrodes

monopolar, for Hysteroscopy, 7 Charr.
(to use with 4.0 mm Hysteroscopes)

see page 10

Instruments for Resectoscopy



Working element, passive
single stem, handle Aluminium, coated
cutting by spring action - in still position
the electrode is inside the sheath

H50-000-000 with closed handle

H50-001-000 with open handle

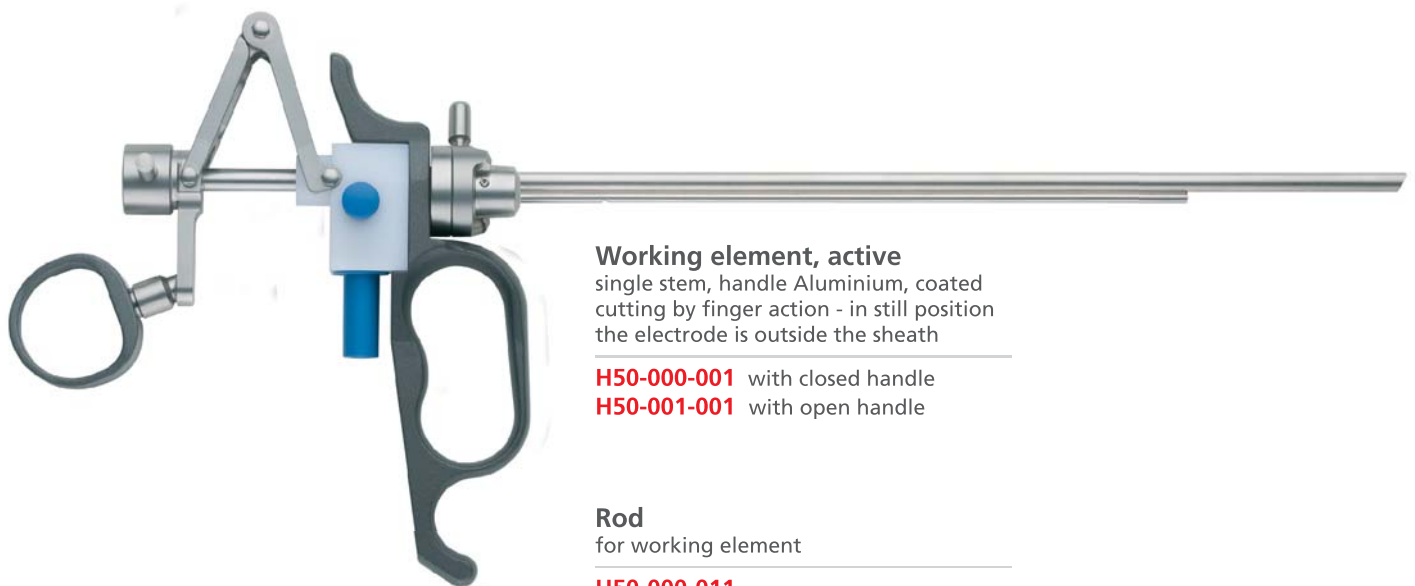
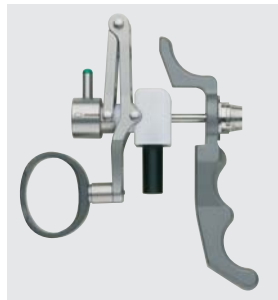

Working element, active
single stem, handle Aluminium, coated
cutting by finger action - in still position
the electrode is outside the sheath

H50-000-001 with closed handle

H50-001-001 with open handle

Rod
for working element

H50-000-011

Instruments for Resectoscopy



Loop electrode
angled 30°
single stem

24 Charr. **H50-024-200**
27 Charr. **H50-027-200**



Loop electrode
straight
single stem

24 Charr. **H50-024-201**
27 Charr. **H50-027-201**



Loop electrode
90° angled, for 0° scope
single stem

24 Charr. **H50-024-202**
27 Charr. **H50-027-202**



Knife electrode
single stem

24 Charr. **H50-024-203**
27 Charr. **H50-027-203**



Ball electrode
Ø 3 mm
single stem

24 Charr. **H50-024-204**
27 Charr. **H50-027-204**



Ball electrode
Ø 5 mm
single stem

24 Charr. **H50-024-205**
27 Charr. **H50-027-205**



Roller electrode
Ø 3 mm
single stem

24 Charr. **H50-024-206**
27 Charr. **H50-027-206**



Roller electrode
Ø 5 mm
single stem

24 Charr. **H50-024-207**
27 Charr. **H50-027-207**



Conical electrode
single stem

24 Charr. **H50-024-208**
27 Charr. **H50-027-208**

Instruments for Resectoscopy



Spike electrode

Ø 3 mm
single stem

24 Charr. **H50-024-209**
27 Charr. **H50-027-209**



Spike electrode

Ø 5 mm
single stem

24 Charr. **H50-024-210**
27 Charr. **H50-027-210**



Vaporization electrode

Ø 3 mm
single stem

24 Charr. **H50-024-211**
27 Charr. **H50-027-211**



Vaporization electrode

Ø 5 mm
single stem

24 Charr. **H50-024-212**
27 Charr. **H50-027-212**



Curette

sharp, round
single stem

24 Charr. **H50-024-213**
27 Charr. **H50-027-213**

Double stem electrodes on request



Protection groove for electrodes

Stainless steel

24 Charr. **H50-030-000**

connection to unit



HF-connection cable

Martin/Berchtold, Ø 4 mm

3 meters **H50-050-010**
5 meters **H50-055-010**

connection to unit



HF-connection cable

Erbe/Storz, Ø 5 mm

3 meters **H50-050-011**
5 meters **H50-055-011**

connection to unit



HF-connection cable

Valleylab/Bovie, Ø 8 mm

3 meters **H50-050-012**
5 meters **H50-055-012**

Instruments for Resectoscopy

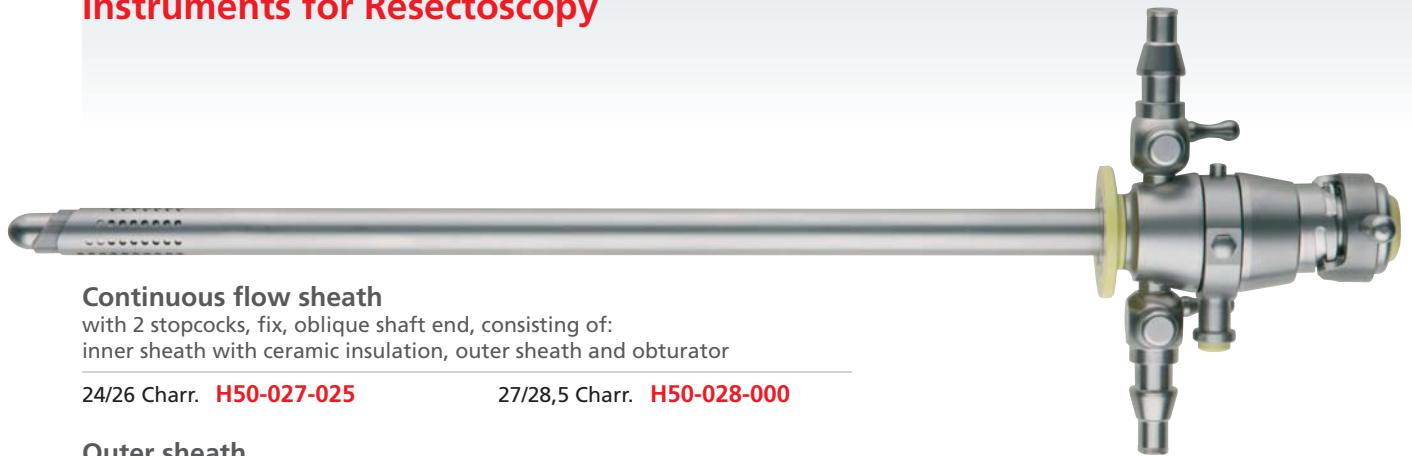

Continuous flow sheath

with 2 stopcocks, fix, oblique shaft end, consisting of:
inner sheath with ceramic insulation, outer sheath and obturator

24/26 Charr. **H50-027-025** 27/28,5 Charr. **H50-028-000**

Outer sheath

for continuous flow sheath with 2 stopcocks, fix

26 Charr. **H50-027-027** 28,5 Charr. **H50-028-002**

Inner sheath

with ceramic insulation for continuous flow sheath with 2 stopcocks, fix

24 Charr. **H50-024-026** 27 Charr. **H50-027-028**

Obturator

for resectoscope sheaths

24 Charr. **H50-024-040** 27 Charr. **H50-027-040**

To use with scopes Ø 4 mm, 302 mm length

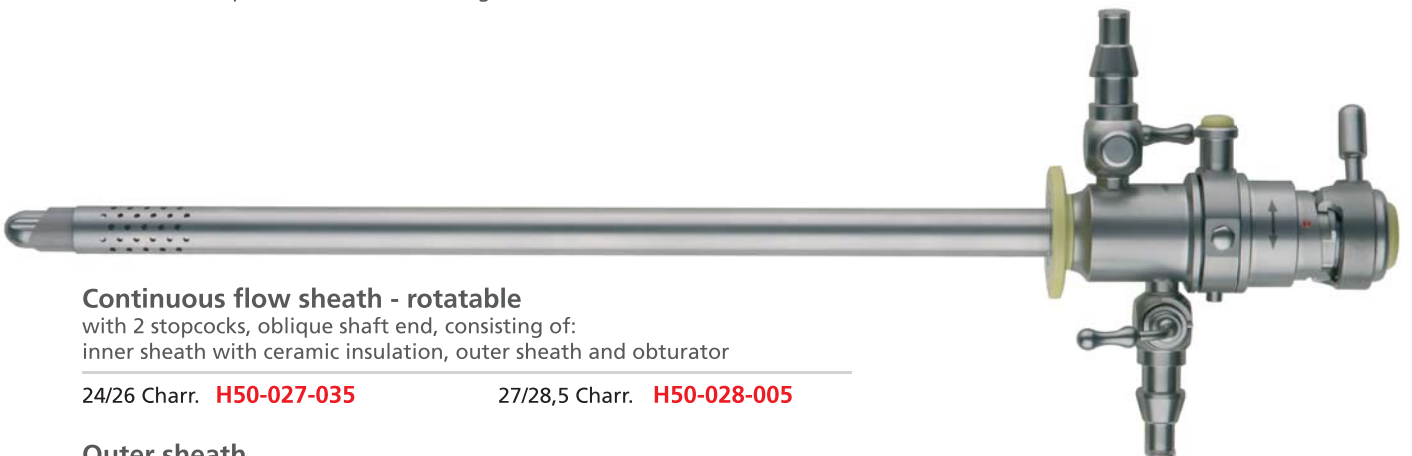

Continuous flow sheath - rotatable

with 2 stopcocks, oblique shaft end, consisting of:
inner sheath with ceramic insulation, outer sheath and obturator

24/26 Charr. **H50-027-035** 27/28,5 Charr. **H50-028-005**

Outer sheath

for continuous flow sheath with 2 stopcocks, rotating

26 Charr. **H50-027-037** 28,5 Charr. **H50-028-007**

Inner sheath

with ceramic insulation for continuous flow sheath with 2 stopcocks, rotating

24 Charr. **H50-024-036** 27 Charr. **H50-027-030**

Obturator

for resectoscope sheaths

24 Charr. **H50-024-040** 27 Charr. **H50-027-040**

To use with scopes Ø 4 mm, 302 mm length

Ringapplicator



Ringapplicator

First puncture for use with Operation Laparoscope.
Complete with loading device

working length 355 mm, 6.0 mm **H51-300-000**

Loading device **H51-300-001**

Conus piece **H51-300-002**

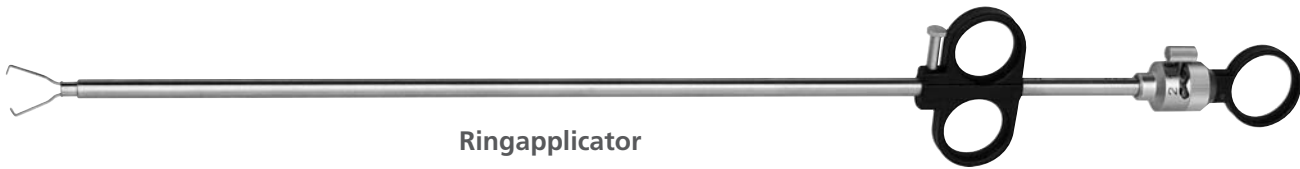

Ringapplicator

Second puncture for use with Trocar Sleeve.
Complete with loading device

working length 300 mm, 6.5 mm **H51-301-000**

Loading device **H51-300-001**

Conus piece **H51-300-002**

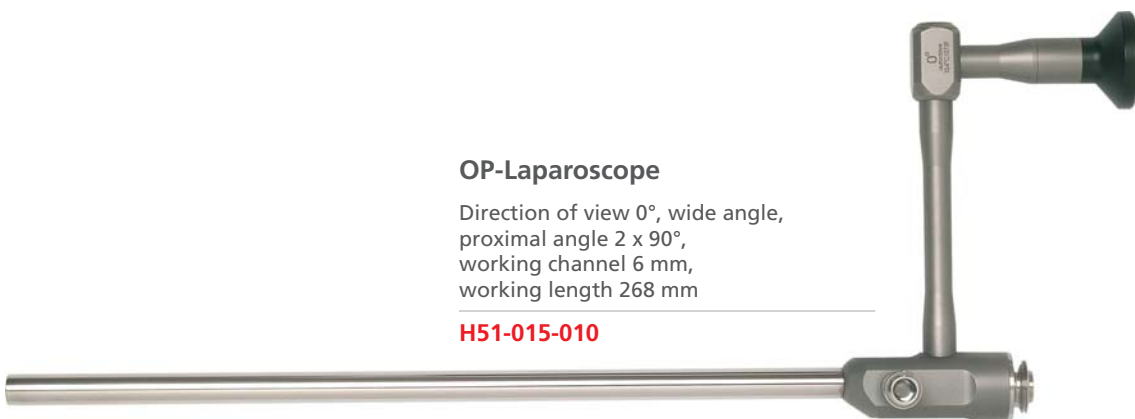

OP-Laparoscope

Direction of view 0°, wide angle,
proximal angle 2 x 90°,
working channel 6 mm,
working length 268 mm

H51-015-010



Adaptor for OP-Laparoscope

H51-015-011

Uterus Manipulator

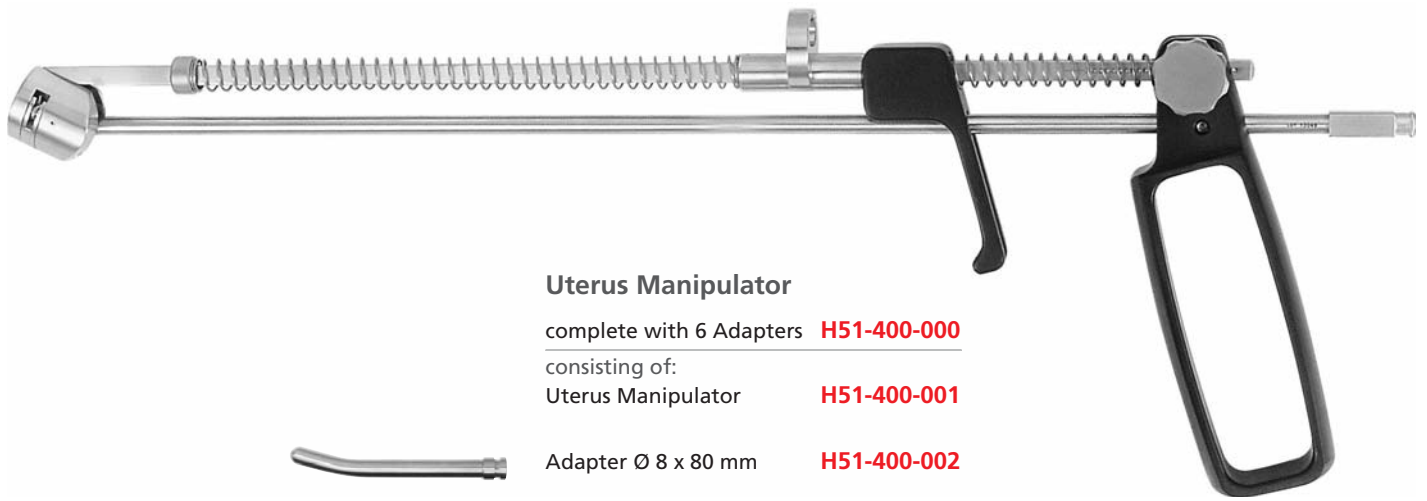







Uterus Manipulator

complete with 6 Adapters **H51-400-000**

consisting of:

Uterus Manipulator **H51-400-001**

- | | | |
|---|-------------------------|--------------------|
|  | Adapter Ø 8 x 80 mm | H51-400-002 |
|  | Adapter Ø 10 x 100 mm | H51-400-003 |
|  | Adapter Ø 3 x 45 mm | H51-400-004 |
|  | Adapter Ø 3 x 55 mm | H51-400-005 |
|  | Adapter with cone long | H51-400-006 |
|  | Adapter with cone short | H51-400-007 |

Instruments



Myoma Drill

Ø 5.0 mm

working length 320 mm **H80-320-005**
working length 370 mm **H80-370-005**

Ø 10.0 mm

working length 300 mm **H80-300-010**
working length 330 mm **H80-330-010**

Ø 11.0 mm

working length 320 mm **H80-320-011**
working length 370 mm **H80-370-011**



Tube Dilator

Ø 5.0 mm

working length 340 mm **H51-430-000**

Instruments



Cohen Intra Uterine Probe

complete **H51-450-000**

consisting of:
Cohen-Cannula **H51-450-001**

Portio Adapter small **H51-450-002**

Portio Adapter large **H51-450-003**



Uterine Probe

Sims, 32 cm length

H170-58032 rigid

H170-58132 maleable



Uterine Probe

Martin, 32 cm length

H170-58232 rigid

H170-58332 maleable



Uterine Probe

Collin, 28 cm length

H170-58428 rigid

Instruments



Uterine Tenaculum Forceps

Schröder, 25 cm length

H170-50225

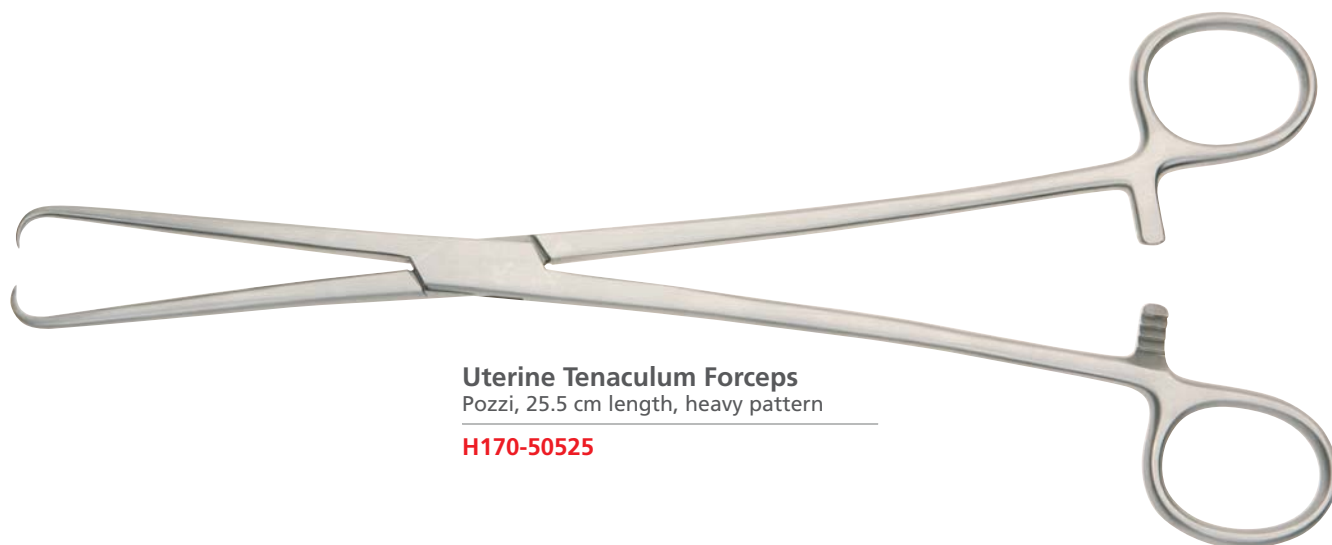

Uterine Tenaculum Forceps

Pozzi, 25.5 cm length, heavy pattern

H170-50525

Hystro-Insufflator



SAFETY

Automatic self check, activated each time unit is switched on, makes sure all electronic and pneumatic components are in good running order. This safety feature carries a guarantee for the lifetime of the unit. The changeable sterile filter prevents reflux of liquids and contamination of the gas way.

SYSTEM GAS HEATER

For reduction of post surgery problems the HI-series is available with a high efficient gas heater. The gas heater is preadjusted and works on a plug and play base full automatically. The heat exchanger can be autoclaved with the tube set.

FLEXIBLE GAS SUPPLY

The HI-series can be used with gas bottles or central gas supply systems. The gas supply mode can be changed very easily by integrated software.

VIDEO OSDD (optional)

The OSDD (On-Screen-Data-Display) gives the surgeon the possibility to display the important values on the video monitor of the endoscopic camera.

Option:

With Video On-Screen-Data-Display

H95-001-00X-D

Delivery contains:

Insufflator
Mains Cable
CO₂ high pressure tube UNF to German gas connection
Wrench set: SW 15 / SW 30
Sterile filter
Standard silicone tube set (not -H version)
System gas heater with tube set (only -H version)
Video cable (only -V version)
User manual

Accessories for Insufflator and Hystro-Insufflator

Sterile-filter package with 50 pcs	H95-000-050
Sterile-filter package with 100 pcs	H95-000-100
Sterile-filter package with 250 pcs	H95-000-250
Sterile-filter package with 500 pcs	H95-000-500
CO ₂ high pressure tube set (autocavable)	H95-000-600
CO ₂ high pressure tube set (autocavable) with heater exchanger	H95-000-601

	EU-Version	US-Version
	H95-001-000	H95-001-001
Type	HHI-0200	HHI-0201
Pressure	0 - 200 mm Hg	0 - 150 mm Hg
Max. gas flow	0 - 100 ml/min	
Power supply	100 - 240 VAC, 50 - 60 Hz, 65 W	
External dimensions	353 x 103 x 253 mm (W x H x D)	
Weight	7 kg	

Order Number Index

<i>art.-no.</i>	<i>page</i>	<i>art.-no.</i>	<i>page</i>	<i>art.-no.</i>	<i>page</i>
H166-16820	40	H166-20538	38	H188-99001	4
H166-16828	40	H166-20540	38	H188-99002	4
H166-17508	40	H166-21108	39	H188-99003	4
H166-17711	40	H166-21110	39	H50-000-000	18,29,49
H166-18439	40	H166-21112	39	H50-000-001	18,49
H166-18535	40	H166-21114	39	H50-000-002	24
H166-20108	38	H166-21116	39	H50-000-003	24
H166-20110	38	H166-21118	39	H50-000-004	26,29
H166-20112	38	H166-21120	39	H50-000-008	26,29
H166-20114	38	H166-21122	39	H50-000-011	18,49
H166-20116	38	H166-21124	39	H50-000-500	17
H166-20118	38	H166-21308	39	H50-001-000	18,29
H166-20120	38	H166-21310	39	H50-001-000	49
H166-20122	38	H166-21312	39	H50-001-001	18,49
H166-20124	38	H166-21314	39	H50-001-002	24
H166-20126	38	H166-21316	39	H50-001-003	24
H166-20128	38	H166-21318	39	H50-003-010	11,28
H166-20130	38	H166-21320	39	H50-003-011	11,28
H166-20132	38	H166-21322	39	H50-003-012	11,28
H166-20134	38	H166-21324	39	H50-003-013	11,28
H166-20136	38	H166-21908	39	H50-003-015	11
H166-20508	38	H166-21910	39	H50-003-016	11
H166-20510	38	H166-21912	39	H50-003-017	11
H166-20512	38	H166-21914	39	H50-003-018	11
H166-20514	38	H166-21916	39	H50-005-010	11
H166-20516	38	H166-21918	39	H50-005-011	11
H166-20518	38	H166-21920	39	H50-005-012	11
H166-20520	38	H166-21922	39	H50-005-013	11
H166-20522	38	H166-21924	39	H50-005-015	11
H166-20524	38	H170-50225	57	H50-005-016	11
H166-20526	38	H170-50525	57	H50-005-017	11
H166-20528	38	H170-58032	56	H50-005-018	11
H166-20530	38	H170-58132	56	H50-007-007	11
H166-20532	38	H170-58232	56	H50-007-010	11
H166-20534	38	H170-58332	56	H50-007-011	11
H166-20536	38	H170-58428	56	H50-007-012	11

<i>art.-no.</i>	<i>page</i>	<i>art.-no.</i>	<i>page</i>	<i>art.-no.</i>	<i>page</i>	<i>art.-no.</i>	<i>page</i>	<i>art.-no.</i>	<i>page</i>
H50-007-013	11	H50-013-020	27	H50-019-012	7	H50-021-510	14	H50-024-201	19, 50
H50-007-015	11	H50-013-021	27	H50-019-015	6	H50-021-511	14	H50-024-202	19, 50
H50-007-016	11	H50-013-022	27	H50-019-016	6	H50-021-512	14	H50-024-203	19, 50
H50-007-018	11	H50-013-023	27	H50-019-017	7	H50-021-512	15	H50-024-204	19, 50
H50-009-010	11	H50-013-024	27	H50-019-018	25	H50-021-515	15	H50-024-205	19, 50
H50-009-011	11	H50-013-041	30	H50-019-019	24	H50-021-516	15	H50-024-206	19, 50
H50-009-012	11	H50-013-042	30	H50-019-020	25	H50-021-600	15	H50-024-207	19, 50
H50-009-013	11	H50-013-220	31	H50-019-021	25	H50-022-000	24	H50-024-208	19, 50
H50-009-015	11	H50-013-221	31	H50-021-010	6	H50-022-002	24	H50-024-209	20, 51
H50-009-016	11	H50-013-224	31	H50-021-011	6	H50-022-003	24,25	H50-024-210	20, 51
H50-009-017	11	H50-013-225	31	H50-021-012	6	H50-022-004	25	H50-024-211	20, 51
H50-009-018	11	H50-015-010	6	H50-021-012	6	H50-022-006	25	H50-024-212	20,51
H50-011-010	26	H50-015-011	6	H50-021-012	7	H50-022-007	25	H50-024-213	20,51
H50-011-011	26	H50-015-012	6	H50-021-015	6	H50-023-010	6	H50-025-010	6
H50-011-012	26	H50-015-012	7	H50-021-016	6	H50-023-011	6	H50-025-011	6
H50-011-015	27	H50-017-010	6	H50-021-017	7	H50-023-012	6,7	H50-025-012	6
H50-011-016	27	H50-017-011	6	H50-021-021	30	H50-023-015	6	H50-025-012	6,7
H50-011-017	27	H50-017-012	6	H50-021-022	30	H50-023-016	6	H50-025-015	6
H50-011-020	27	H50-017-012	6	H50-021-024	30	H50-023-017	7	H50-025-016	6
H50-011-021	27	H50-017-012	7	H50-021-025	30	H50-023-510	16	H50-025-017	7
H50-011-022	27	H50-017-015	6	H50-021-100	12	H50-023-511	16	H50-027-025	21,52
H50-011-023	27	H50-017-016	6	H50-021-101	12	H50-023-512	16	H50-027-027	21,52
H50-011-024	27	H50-017-017	7	H50-021-102	12	H50-023-517	17	H50-027-028	21,52
H50-011-041	30	H50-017-021	30	H50-021-103	12	H50-023-520	17	H50-027-030	21,52
H50-011-042	30	H50-017-022	30	H50-021-104	12	H50-024-026	21,52	H50-027-035	21,52
H50-011-220	31	H50-017-220	31	H50-021-105	13	H50-024-036	21,52	H50-027-037	21,52
H50-011-221	31	H50-017-221	31	H50-021-106	12	H50-024-040	21,22,23	H50-027-040	21-23,52
H50-011-224	31	H50-017-222	31	H50-021-107	12	H50-024-040	52	H50-027-041	23
H50-011-225	31	H50-017-224	31	H50-021-110	12	H50-024-041	23	H50-027-042	23
H50-013-010	26	H50-019-004	24	H50-021-111	13	H50-024-042	23	H50-027-050	22
H50-013-011	26	H50-019-005	24	H50-021-220	31	H50-024-050	22	H50-027-051	22
H50-013-012	26	H50-019-006	24	H50-021-221	31	H50-024-051	22	H50-027-060	22
H50-013-015	27	H50-019-010	6	H50-021-222	31	H50-024-060	22	H50-027-061	22
H50-013-016	27	H50-019-011	6	H50-021-223	31	H50-024-061	22	H50-027-142	23
H50-013-017	27	H50-019-012	6	H50-021-224	31	H50-024-142	23	H50-027-200	19, 50
H50-013-018	26	H50-019-012	6	H50-021-500	14	H50-024-200	19, 50	H50-027-201	19, 50

Order Number Index

<i>art.-no.</i>	<i>page</i>	<i>art.-no.</i>	<i>page</i>	<i>art.-no.</i>	<i>page</i>
H50-027-202	19, 50	H50-050-032	32	H50-070-020	35
H50-027-203	19, 50	H50-050-033	32	H50-070-021	35
H50-027-204	19, 50	H50-050-034	32	H50-070-022	35
H50-027-205	19, 50	H50-050-035	32	H50-070-025	35
H50-027-206	19, 50	H50-050-036	32	H50-070-026	35
H50-027-207	19, 50	H50-050-037	32	H50-070-030	36
H50-027-208	19, 50	H50-050-040	9	H50-070-031	36
H50-027-209	20, 51	H50-050-041	9	H50-070-032	36
H50-027-210	20, 51	H50-050-042	9	H50-070-033	36
H50-027-211	20, 51	H50-051-000	10	H50-070-034	36
H50-027-212	20, 51	H50-052-000	10	H50-070-035	36
H50-027-213	20, 51	H50-055-010	20	H50-070-036	36
H50-028-000	21, 52	H50-055-011	20	H50-070-037	36
H50-028-002	21, 52	H50-055-011	51	H50-070-038	36
H50-028-005	21, 52	H50-055-012	20,51	H50-070-039	36
H50-028-007	21, 52	H50-055-050	32	H50-070-040	36
H50-030-000	20, 51	H50-055-075	32	H50-070-041	36
H50-040-000	33	H50-055-100	32	H50-071-015	35
H50-040-001	33	H50-055-150	32	H50-071-016	35
H50-040-002	33	H50-055-200	32	H50-071-025	35
H50-040-003	33	H50-056-050	32	H50-071-026	35
H50-040-004	33	H50-056-075	32	H50-080-000	37
H50-040-005	33	H50-056-100	32	H50-080-001	37
H50-050-000	8	H50-056-150	32	H50-080-010	37
H50-050-001	8	H50-056-200	32	H50-080-100	37
H50-050-002	8	H50-060-012	8	H50-080-101	37
H50-050-003	31	H50-060-013	8	H50-080-102	37
H50-050-004	31	H50-060-014	26	H50-080-103	37
H50-050-005	31	H50-061-011	8	H50-080-104	37
H50-050-010	20, 51	H50-070-000	34	H50-080-105	37
H50-050-011	20,51	H50-070-001	34	H50-080-106	37
H50-050-012	20,51	H50-070-005	34	H50-080-107	37
H50-050-020	30	H50-070-012	35	H50-080-108	37
H50-050-021	31	H50-070-015	35	H50-080-109	37
H50-050-023	30	H50-070-016	35	H50-080-200	37
H50-050-030	32	H50-070-017	35	H50-080-201	37

<i>art.-no.</i>	<i>page</i>	<i>art.-no.</i>	<i>page</i>	<i>art.-no.</i>	<i>page</i>	<i>art.-no.</i>	<i>page</i>	<i>art.-no.</i>	<i>page</i>
H50-080-202	37	H50-752-001	10	H51-061-000	44	H51-400-003	54	H91-100-001	5
H50-080-203	37	H50-752-002	10	H51-061-002	44	H51-400-004	54	H91-100-002	5
H50-080-204	37	H50-760-000	9	H51-061-003	44	H51-400-005	54	H91-100-003	5
H50-080-205	37	H50-760-001	9	H51-070-001	44	H51-400-006	54	H91-100-010	5
H50-080-206	37	H50-760-002	9	H51-071-000	44	H51-400-007	54	H91-100-020	5
H50-080-207	37	H50-760-003	9	H51-071-002	44	H51-430-000	55	H91-100-030	5
H50-080-208	37	H50-851-000	10	H51-071-003	44	H51-450-000	56	H91-100-050	5
H50-080-209	37	H50-852-000	10	H51-090-001	45	H51-450-001	56	H91-180-035	5
H50-095-010	26	H50-951-000	10	H51-090-002	45	H51-450-002	56	H91-180-045	5
H50-095-011	26	H50-951-002	10	H51-091-005	45	H51-450-003	56	H91-230-035	5
H50-095-012	26	H50-952-000	10	H51-091-006	45	H80-300-010	55	H91-230-045	5
H50-150-010	10	H50-952-002	10	H51-110-001	45	H80-320-005	55	H91-300-035	5
H50-351-000	10,28	H51-010-001	43	H51-110-002	45	H80-320-011	55	H91-300-045	5
H50-351-001	10,28	H51-010-002	43	H51-120-001	45	H80-330-010	55	H95-000-050	58
H50-351-002	28	H51-011-001	43	H51-120-002	45	H80-370-005	55	H95-000-100	58
H50-352-000	10	H51-011-002	43	H51-210-001	46	H80-370-011	55	H95-000-250	58
H50-352-001	10	H51-012-000	43	H51-210-002	46	H82-020-000	4	H95-000-500	58
H50-400-000	7	H51-015-010	53	H51-210-003	46	H82-027-000	4	H95-000-600	58
H50-451-000	10	H51-015-011	53	H51-210-004	46	H82-027-012	4	H95-000-601	58
H50-452-000	10	H51-020-001	43	H51-220-001	46	H82-027-030	4	H95-001-000	58
H50-551-000	10	H51-020-002	43	H51-220-002	46	H82-027-070	4	H95-001-001	58
H50-551-001	10	H51-021-001	43	H51-220-003	46	H82-187-000	4	H95-001-00X-D	58
H50-551-002	10	H51-021-002	43	H51-220-004	46	H82-187-030	4		
H50-552-000	10	H51-022-000	43	H51-250-001	47	H82-187-070	4		
H50-552-001	10	H51-030-001	43	H51-251-000	47	H82-430-000	4		
H50-552-002	10	H51-030-002	43	H51-251-001	47	H82-430-012	4		
H50-560-000	9	H51-030-003	43	H51-260-001	48	H82-430-030	4		
H50-560-001	9	H51-031-001	43	H51-261-001	48	H82-430-070	4		
H50-560-002	9	H51-031-002	43	H51-262-001	48	H85-027-000	42		
H50-560-003	9	H51-031-003	43	H51-300-000	53	H85-027-012	42		
H50-651-000	10	H51-032-000	43	H51-300-001	53	H85-027-030	42		
H50-652-000	10	H51-050-001	44	H51-300-002	53	H85-027-070	42		
H50-751-000	10	H51-051-000	44	H51-301-000	53	H85-040-000	42		
H50-751-001	10	H51-051-002	44	H51-400-000	54	H85-040-012	42		
H50-751-002	10	H51-051-003	44	H51-400-001	54	H85-040-030	42		
H50-752-000	10	H51-060-001	44	H51-400-002	54	H85-040-070	42		

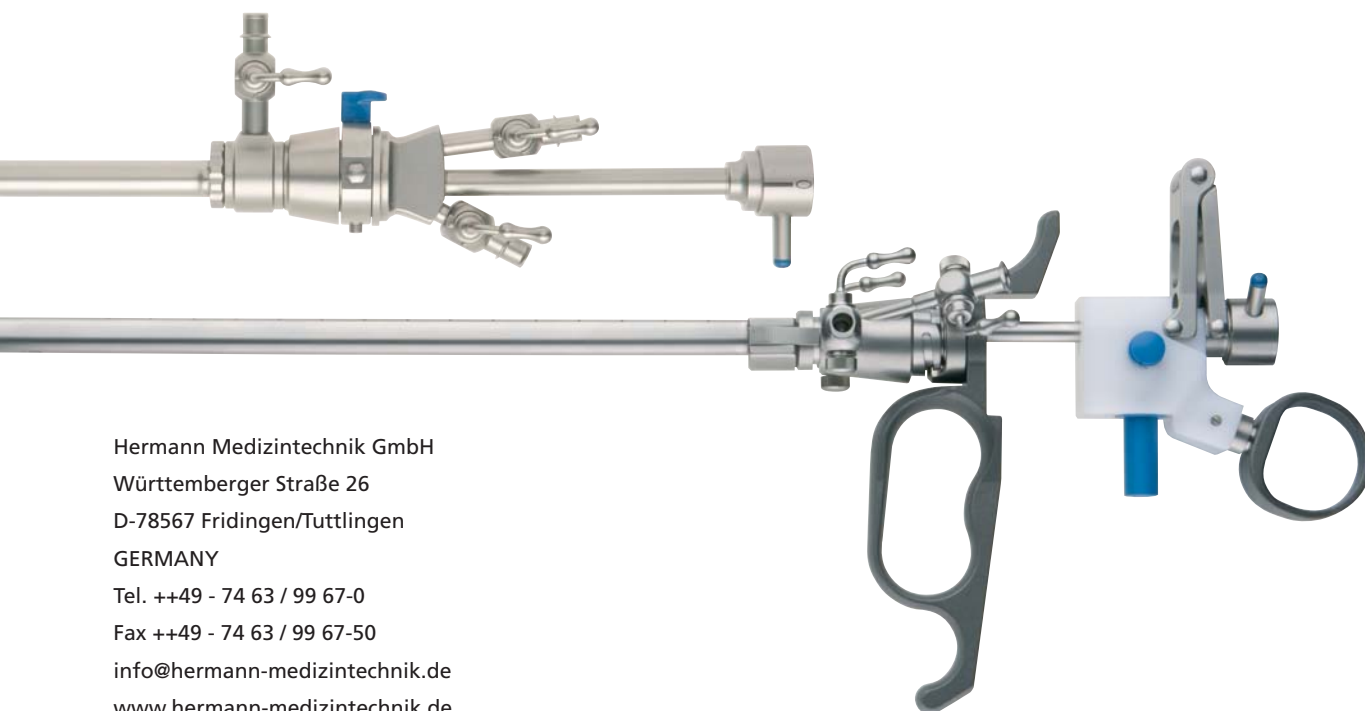

Hermann Medizintechnik GmbH
Württembergischer Straße 26
D-78567 Fridingen/Tuttlingen
GERMANY
Tel. ++49 - 74 63 / 99 67-0
Fax ++49 - 74 63 / 99 67-50
info@hermann-medizintechnik.de
www.hermann-medizintechnik.de